



# LoRaWAN<sup>®</sup> Solenoid Valve Controller

**UC51x Series**

User Guide



## Safety Precautions

Milesight will not shoulder responsibility for any loss or damage resulting from not following the instructions of this operating guide.

- ❖ The device must not be remodeled in any way.
- ❖ Do not place the device close to objects with naked flames.
- ❖ Do not place the device where the temperature is below/above the operating range.
- ❖ Make sure electronic components do not drop out of the enclosure while opening.
- ❖ When installing the battery, please install it accurately, and do not install the reverse or wrong model.
- ❖ The device must never be subjected to shocks or impacts.

## Declaration of Conformity

UC51x series is in conformity with the essential requirements and other relevant provisions of the CE, FCC, and RoHS.

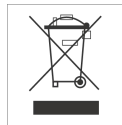

Copyright©2011-2022 Milesight. All rights reserved.

All information in this guide is protected by copyright law. Whereby, no organization or individual shall copy or reproduce the whole or part of this user guide by any means without written authorization from Xiamen Milesight IoT Co., Ltd.

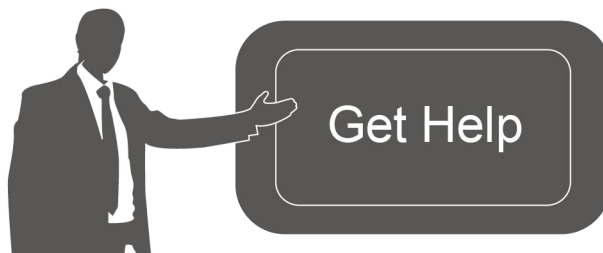

For assistance, please contact

Milesight technical support:

Email: [iot.support@milesight.com](mailto:iot.support@milesight.com)

Tel: 86-592-5085280

Fax: 86-592-5023065

Address: Building C09, Software Park III,  
Xiamen 361024, China

## Revision History

Date	Doc Version	Description
Feb. 20, 2021	V 1.0	Initial version
Nov.26, 2021	V 1.1	Description Update
March 10, 2021	V 2.0	Update based on 2.0 hardware
June 15, 2022	V 2.1	<ol style="list-style-type: none"><li>1. Add internal interface description;</li><li>2. UC511 supports Class C to B mode;</li><li>3. GPIO supports selecting DI or pulse mode;</li><li>4. Update re-join mode and confirmed mode description.</li></ol>

# Contents

1. Product Introduction .....	5
1.1 Overview .....	5
1.2 Features .....	5
2. Hardware Introduction .....	5
2.1 Packing List .....	5
2.2 Hardware Overview .....	6
2.3 Internal Interfaces .....	6
2.4 Dimensions .....	7
3. Operation Guide .....	7
3.1 Log in the ToolBox .....	7
3.1.1 NFC Configuration .....	7
3.1.2 USB Configuration .....	8
3.2 Solenoid Valve Control .....	9
3.3 LoRaWAN Settings .....	10
3.4 Solenoid Settings .....	13
3.5 Schedule Settings .....	15
3.6 Maintenance .....	16
3.6.1 Upgrade .....	16
3.6.2 Backup .....	17
3.6.3 Reset to Factory Default .....	18
4. Installation .....	19
5. Milesight IoT Cloud Management .....	20
5.1 Add UC51x to Cloud .....	20
5.2 Solenoid Valve Control .....	22
6. Device Payload .....	24

## 1. Product Introduction

### 1.1 Overview

UC51x series LoRaWAN® wireless solenoid valve controller is a device used to remotely control DC latching solenoids of the valve. It contains 2 solenoid interfaces and 2 GPIO interfaces, which can be easily controlled locally or remotely.

Besides ultra-low-power LoRaWAN® technology, UC51x series also provides both solar and built-in battery power supply for uninterrupted operation. For outdoor applications, it equips with IP67-rated enclosure and M12 connectors to protect from water and dust under harsh environments.

### 1.2 Features

- Compatible with standard DC latching solenoids
- OPEN/CLOSE control by mobile App locally or commands remotely
- Two GPIO interfaces for flow monitoring or valve status monitoring
- Transmission distance up to 15 km with line of sight
- Waterproof design including IP67 case and M12 connectors
- Solar powered and built-in chargeable battery
- Quick wireless configuration via NFC
- Time and flow control via Milesight IoT Cloud

## 2. Hardware Introduction

### 2.1 Packing List



1 × UC51x  
Device



2 × Data Cables  
(1.5 m)

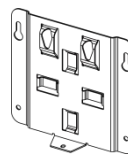

1 × Mounting  
Bracket

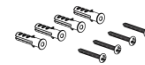

4 × Wall  
Mounting Kits

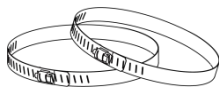

2 × Hose Clamps



1 × Fixing Screw



1 × Quick Guide



1 × Warranty Card



**If any of the above items is missing or damaged, please contact your sales Representative.**

## 2.2 Hardware Overview

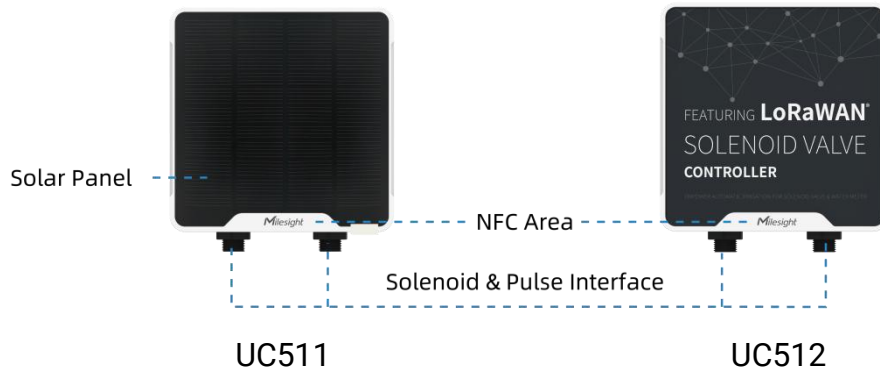

### Interface 1&2:

Pin	Description
1	DC+/OUT1 of Solenoid Valve
2	DC-/OUT2 of Solenoid Valve
3	GND
4	INSERT BOOT <sup>1</sup>
5	GND
6	GPIO Interface

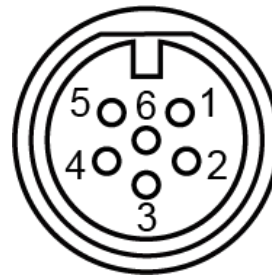

## 2.3 Internal Interfaces

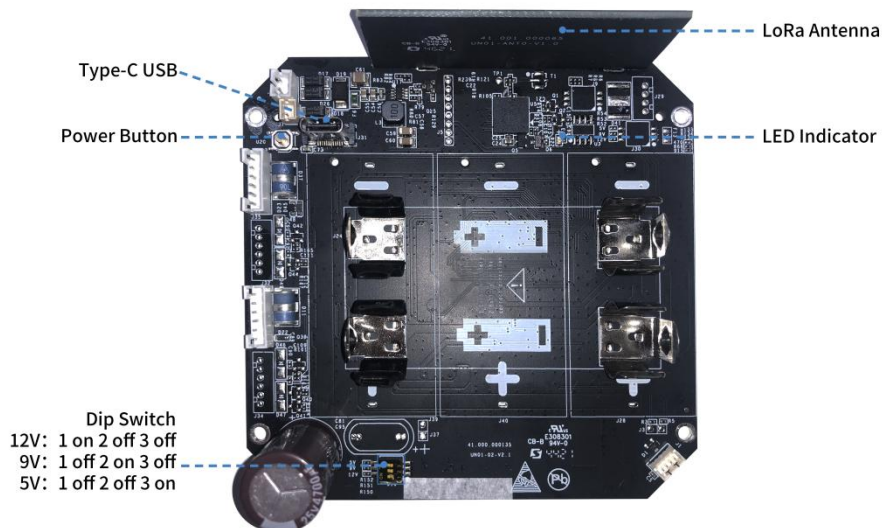

<sup>1</sup> PIN3 and PIN4 do not need to connect, see “Solenoid Valve Switch” option in [section 3.4](#).

**DIP Switch:**

Interface	DIP Switch
Solenoid Interface	12V: 1 on 2 off 3 off
	9V: 1 off 2 on 3 off
	5V: 1 off 2 off 3 on

**Note:**

- 1) The DIP switch is set to 12VDC by default.
- 2) The DIP switch does not support setting two solenoid interfaces as different voltage types.

**Power Button:**

Function	Action	LED Indication
Turn On	Press and hold the button for more than 3s.	Off → On
Turn Off	Press and hold the button for more than 3s.	On → Off
Reset	Press and hold the button for more than 10s.	Blinks.
Check On/Off Status	Quickly press the power button.	Light On: Device is on.
		Light Off: Device is off.

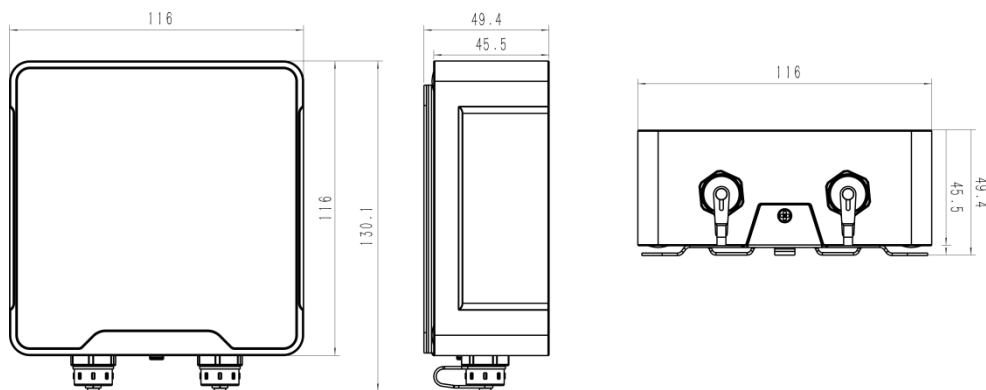
**2.4 Dimensions (mm)****3. Operation Guide****3.1 Log in the ToolBox**

UC51x series can be monitored and configured via ToolBox App or ToolBox software. Please select one of them to complete configuration.

**3.1.1 NFC Configuration**

1. Download and install "Milesight ToolBox" App from Google Play or Apple App Store.

2. Enable NFC on the smartphone and launch Milesight ToolBox.
3. Attach the smartphone with NFC area to the device to read basic information.
4. Basic information and settings of devices will be shown on ToolBox if it's recognized successfully. You can read and configure the device by tapping the button on the Device Status. In order to protect the security of devices, password validation is required when first configuration. Default password is **123456**.



**Note:**

- 1) Ensure the location of smartphone NFC area and it's recommended to take off phone case.
- 2) If the smartphone fails to read/write configurations via NFC, keep the phone away and back to try again.
- 3) UC51x series can also be configured by dedicated NFC reader, which can be purchased from Milesight IoT.

### 3.1.2 USB Configuration

1. Download ToolBox from [Milesight IoT website](#).
2. Open the case of UC51x and connect the UC51x to computer via type-C port.

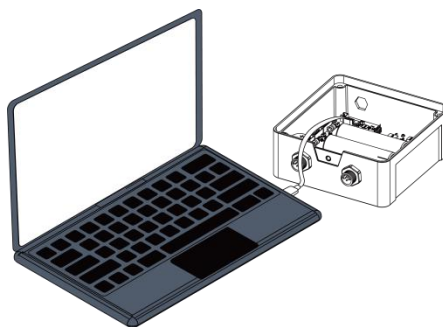

3. Open the ToolBox and select type as "General", then click password to log in ToolBox. (Default password: **123456**)



ToolBox Settings

Type: General

Serial port: COM4

Login password:

Baud rate: 115200

Data bits: 8

Parity bits: None

Stop bits: 1

Save Cancel

4. After logging in the ToolBox, you can click “Power On” or “Power Off” to turn on/off device and change other settings.

Status > Power On

Model:	UC512-DI-868M
Serial Number:	646-██████████
Device EUI:	24e1244-██████████
Firmware Version:	02.02
Hardware Version:	2.1
Device Status:	Off
Join Status:	-
RSSI/SNR:	-
Valve1 Status:	-
Counter1:	12
Valve2 Status:	-
Counter2:	33
Battery:	-
Channel Mask:	-
Uplink Frame-counter:	-
Downlink Frame-counter:	-

## 3.2 Solenoid Valve Control

Solenoid valve can be controlled by ToolBox App or ToolBox software locally.

### Via ToolBox Software:

Click “Open” or “Close” button on the “Status” page to change the status of solenoid valves.

**Status >**

Model:	UC512-DI-868M
Serial Number:	6460C
Device EUI:	24e12440
Firmware Version:	02.02
Hardware Version:	2.1
Device Status:	On
Join Status:	Activate
RSSI/SNR:	-31/10
Valve1 Status:	Open <input type="button" value="Close"/>
Counter1:	1 <input type="button" value="Clear"/>
Valve2 Status:	Close <input type="button" value="Open"/>
Counter2:	17 <input type="button" value="Clear"/>
Battery:	100%
Channel Mask:	00ff

**Via ToolBox App:**

Click buttons of Valve Status on the **"Device -> Status"** page, then attach the smart phone to device to change the status of solenoid valves.

Status	Setting	Maintenance
Device Status	ON	<input checked="" type="checkbox"/>
Join Status	Activated	
RSSI/SNR	-48/10	
Device Time	2022-01-27 09:05	<input type="button" value="Sync"/>
Valve 1 Status	Off	<input type="checkbox"/>
Valve 2 Status	Off	<input type="checkbox"/>
Counter 1	474	<input type="button" value="Clear"/>
Counter 2	438	<input type="button" value="Clear"/>
Battery	100 %	

### 3.3 LoRaWAN Settings

LoRaWAN settings is used for configuring the transmission parameters in LoRaWAN® network.

**Basic LoRaWAN Settings:**

Go to **"LoRaWAN Settings -> Basic"** of ToolBox software or **"Setting -> LoRaWAN Settings"** of ToolBox App to configure join type, App EUI, App Key and other information. You can also keep all settings by default.

Device EUI	24E124
App EUI	24E124C0002A0001
Application Port	85
Join Type	OTAA
LoRaWAN Version	V1.1.0
Application Key	*****
RX2 Data Rate	DR0 (SF12, 125k)
RX2 Frequency	869525000
Spread Factor	SF10-DR2
Confirmed Mode	<input type="checkbox"/>
Rejoin Mode	<input checked="" type="checkbox"/>
Set the number of packets sent	32 packets
ADR Mode	<input checked="" type="checkbox"/>
TXPower	TXPower0-16 dBm

Parameters	Description
Device EUI	Unique ID of the device which can also be found on the label.
App EUI	Default App EUI is 24E124C0002A001.
Application Port	The port used for sending and receiving data, default port is 85.
Join Type	OTAA and ABP mode are available.
LoRaWAN Version	V1.0.2, V1.0.3, V1.1 are available.
Application Key	Appkey for OTAA mode, default is 5572404C696E6B4C6F52613230313823.
Device Address	DevAddr for ABP mode, default is the 5 <sup>th</sup> to 12 <sup>th</sup> digits of SN.
Network Session Key	Nwkskey for ABP mode, default is 5572404C696E6B4C6F52613230313823.
Application Session Key	Appskey for ABP mode, default is 5572404C696E6B4C6F52613230313823.
RX2 Data Rate	RX2 data rate to receive downlinks.
RX2 Frequency	RX2 frequency to receive downlinks. Unit: Hz
Spread Factor	If ADR is disabled, the device will send data via this spread factor.
Confirmed Mode	If the device does not receive ACK packet from network server, it will resend data once.
Rejoin Mode	The device will send a specific number of LinkCheckReq MAC packets to the

	network server every 30 mins to validate connectivity; If there is no response, the device will re-join the network.
Set the number of packets sent	When rejoin mode is enabled, set the number of LinkCheckReq packets sent.
ADR Mode	Allow network server to adjust datarate of the device.
Tx Power	Tx power of the device.

**Note:**

- 1) Please contact sales for device EUI list if there are many units.
- 2) Please contact sales if you need random App keys before purchase.
- 3) Select OTAA mode if you use Milesight IoT cloud to manage devices.
- 4) Only OTAA mode supports rejoin mode.

**LoRaWAN Frequency Settings:**

Go to “LoRaWAN Settings-> Channel” of ToolBox software or “Setting -> LoRaWAN Settings” of ToolBox APP to select supported frequency and select channels to send uplinks. Make sure the channels match the LoRaWAN® gateway.

<input type="checkbox"/>	Index	Frequency/MHz	Max Datarate	Min Datarate
<input checked="" type="checkbox"/>	0	868.1	5-SF7BW125	0-SF12BW125
<input checked="" type="checkbox"/>	1	868.3	5-SF7BW125	0-SF12BW125
<input checked="" type="checkbox"/>	2	868.5	5-SF7BW125	0-SF12BW125
<input type="checkbox"/>	3	0	5-SF7BW125	0-SF12BW125
<input type="checkbox"/>	4	0	5-SF7BW125	0-SF12BW125
<input type="checkbox"/>	5	0	5-SF7BW125	0-SF12BW125
<input type="checkbox"/>	6	0	5-SF7BW125	0-SF12BW125

If frequency is one of CN470/AU915/US915, you can enter the index of the channel that you want to enable in the input box, making them separated by commas.

**Examples:**

1, 40: Enabling Channel 1 and Channel 40

1-40: Enabling Channel 1 to Channel 40

1-40, 60: Enabling Channel 1 to Channel 40 and Channel 60

All: Enabling all channels

Null: Indicates that all channels are disabled

Support Frequency : Enabled Channel Index: 

Channel Index	Frequency/MHz	Channel Spacing/MHz	BW/kHz
0 - 15	915.2 - 918.2	0.2	125
16 - 31	918.4 - 921.4	0.2	125
32 - 47	921.6 - 924.6	0.2	125
48 - 63	924.8 - 927.8	0.2	125
64 - 71	915.9 - 927.1	1.6	500

**Note:**

For -868M model, default frequency is EU868;

For -915M model, default frequency is AU915.

### 3.4 Solenoid Settings

Go to **"Device Settings -> Basic"** of ToolBox software or **"Setting -> General Settings"** of ToolBox App to change the reporting configurations.

Reporting Interval	<input type="text" value="20"/>	min
Solenoid Valve Wiring Switch	<input checked="" type="checkbox"/>	
GPIO1 Acquisition Type	<input type="text" value="Digital input"/>	
GPIO2 Acquisition Type	<input type="text" value="Pulse Counter"/>	
Data Reporting	<input type="text" value="All"/>	
Device Return to Power Supply State	<input type="text" value="Return to previous working state"/>	
Class Type	<input type="text" value="Class A"/>	
Response Time	<input type="text" value="600"/>	s
Change Password	<input type="checkbox"/>	

Parameters	Description
Reporting Interval	Reporting interval of transmitting data to network server. Default: 20min, Range: 1-1080 mins.

Solenoid Valve Wiring Switch	After this parameter is enabled, when users connect the solenoid cable to any solenoid interface, the device will turn on automatically.
GPI01/2 Acquisition Type	Select Digital Input or Pulse Counter. Digital input: detect the state of valve; if any DI changes state, it will upload packet to cover the valve status. Pulse counter: connect water meter to measure the flow.
Data Reporting	Select the contents to report to network server. All: Report all interface status; Valve 1 & Water Meter 1: Report the status of the Valve 1 interface and data of GPI01; Valve 2 & Water Meter 2: Report the status of the Valve 2 interface and data of GPI02.
Device Return to Power Supply State	If the device loses power and return to power supply, the device will be on or off according to this parameter.
Class Type	Working mode of LoRaWAN <sup>®</sup> device. UC511: Class A, Class B and Class C, Class C to B are available; UC512: Class A and Class B are available. <b>Note:</b> for Class B mode, if the device does not receive beacons for more than 30 minutes, it will switch to Class A mode automatically; for Class C to B mode, if the device does not receive beacons for more than 30 minutes, it will switch to Class C mode automatically.
Response Time	When the device works under Class A mode, it only receives control commands every reporting interval comes. In order to shorten the delay time of control, the device will send blank package to allow to receive the control commands every Response Time interval. <b>Note:</b> The shorter the response time, the shorter the battery life.
Ping Slot Periodicity	When the device works under Class B or Class C to B mode, set the interval to open the reception window.
Change Password	Change the password for ToolBox App or software to read/write this device.

**Note:**

- 1) When device connects to network server of Milesight gateway, the blank package will take up the frame count but not show on the package list.
- 2) Reboot or re-join will not affect the counting.

### 3.5 Schedule Settings

Go to “**Device Settings -> Schedule**” of ToolBox software or “**Setting -> Schedule**” of ToolBox App to configure the solenoid switch plans.

1. Configure a plan as your request and enable it.

Item	Status	Initial state of solenoid valve	Start Time	End Time	Water Volume(Pulses)	Repeat	Valve
1	<input checked="" type="checkbox"/>	open	7:15	7:18	5	Every Saturday	1&2
2	<input type="checkbox"/>	Closure	0:0	0:0			
3	<input type="checkbox"/>	Closure	0:0	0:0			
4	<input type="checkbox"/>	Closure	0:0	0:0			
5	<input type="checkbox"/>	Closure	0:0	0:0			
6	<input type="checkbox"/>	Closure	0:0	0:0			
7	<input type="checkbox"/>	Closure	0:0	0:0			
8	<input type="checkbox"/>	Closure	0:0	0:0			
9	<input type="checkbox"/>	Closure	0:0	0:0			
10	<input type="checkbox"/>	Closure	0:0	0:0			
11	<input type="checkbox"/>	Closure	0:0	0:0			
12	<input type="checkbox"/>	Closure	0:0	0:0			
13	<input type="checkbox"/>	Closure	0:0	0:0			
14	<input type="checkbox"/>	Closure	0:0	0:0			
15	<input type="checkbox"/>	Closure	0:0	0:0			
16	<input type="checkbox"/>	Closure	0:0	0:0			

Clear All      Read Schedule      Save Schedule      Write

Condition	Description
Item	It supports adding 16 plans at most.
Status	Enable or disable this plan.
Initial State of Solenoid Valve	Control the solenoid to open or close the valve during the plan.
Start Time/End Time	Set the time range to execute this plan.
Water Volume (Pulses)	Set the amount of water flow through the valve during this plan, 0 means this condition will not work. <b>Note:</b> 1) Either time or water volume reaches the condition, the plan is completed and will stop executing. 2) When the GPIO type is not pulse counter, this condition will not work.
Repeat	Set the regularly weekly schedule to execute this plan. If none is selected, the plan will only execute once.

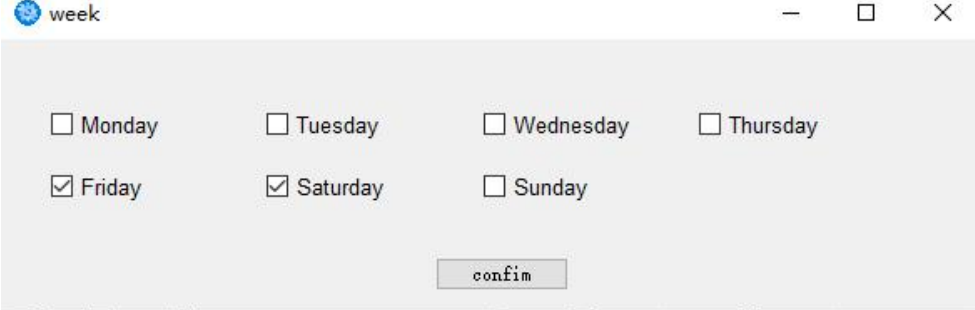
	 <p>week</p> <p><input type="checkbox"/> Monday    <input type="checkbox"/> Tuesday    <input type="checkbox"/> Wednesday    <input type="checkbox"/> Thursday</p> <p><input checked="" type="checkbox"/> Friday    <input checked="" type="checkbox"/> Saturday    <input type="checkbox"/> Sunday</p> <p><input type="button" value="confirm"/></p>
Valve	Select the valve you need to control.

2. Click "Write" to write the schedule plan setting into the device.
3. Click "Save Schedule" to backup the schedule plan settings as file; if you need to import this schedule from other devices, click "Read Schedule" to import the setting.
4. Click "Clear All" to reset all schedule plan settings in this device.

**Note:**

- 1) Ensure the device time is correct. After joining the network, the network server will assign the time to the device. You can also manually sync the time via ToolBox or downlink commands.
- 2) When the device has multiple schedule plan settings that are conflicted, the device will only execute one plan whose item number is largest.

## 3.6 Maintenance

### 3.6.1 Upgrade

#### ToolBox Software:

1. Download firmware from [www.milesight-iot.com](http://www.milesight-iot.com) to your PC.
2. Go to "**Maintenance -> Upgrade**" of ToolBox software, click "**Browse**" to import firmware and upgrade the device. You can also click "**Up to Date**" to search for the latest firmware of the device and upgrade.

#### Maintenance >

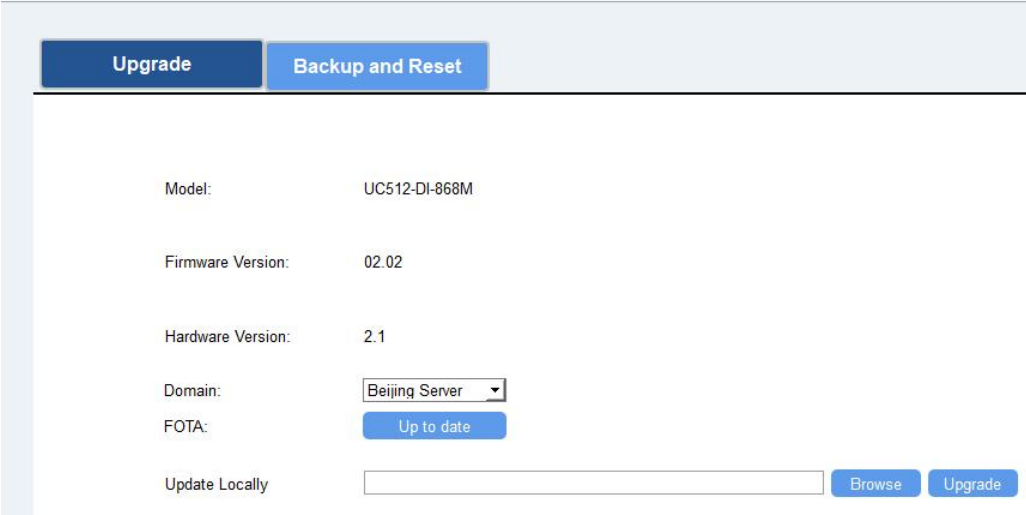

The screenshot shows the 'Upgrade' tab selected in the 'Maintenance >' section. The page displays the following information and controls:

- Model:** UC512-DI-868M
- Firmware Version:** 02.02
- Hardware Version:** 2.1
- Domain:** Beijing Server (dropdown menu)
- FOTA:** Up to date (button)
- Update Locally:** [input field] [Browse] [Upgrade]



## ToolBox App:

1. Download firmware from [www.milesight-iot.com](http://www.milesight-iot.com) to your smartphone.
2. Open ToolBox App and click "Browse" to import firmware and upgrade the device.

### Note:

- 1) Operation on ToolBox is not supported during the upgrade.
- 2) Only Android version ToolBox supports the upgrade feature.

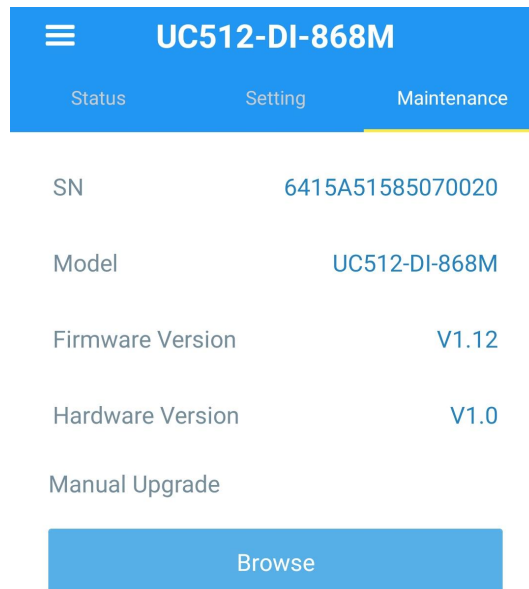

## 3.6.2 Backup

UC51x devices support configuration backup for easy and quick device configuration in bulk.

Backup is allowed only for devices with the same model and LoRa frequency band. Note that the backup file will not save schedule setting, please backup plan setting on "Schedule" page.

Please select one of following methods to backup device:

### ToolBox Software:

1. Go to "**Maintenance -> Backup and Reset**", click "Export" to save current configuration as json format backup file.
2. Click "Browse" to select backup file, then click "Import" to import the configurations.

The screenshot shows the 'Backup and Reset' section of the Milesight IoT interface. It contains three rows of controls:

- Config Backup:** A blue button labeled 'Export'.
- Config File:** A text input field, a blue button labeled 'Browse', and a blue button labeled 'Import'.
- Restore Factory Defaults:** A blue button labeled 'Reset'.

### ToolBox App:

1. Go to "Template" page on the App and save current settings as a template. You can also edit the template file.
2. Select this template and attach to another device to write configuration.

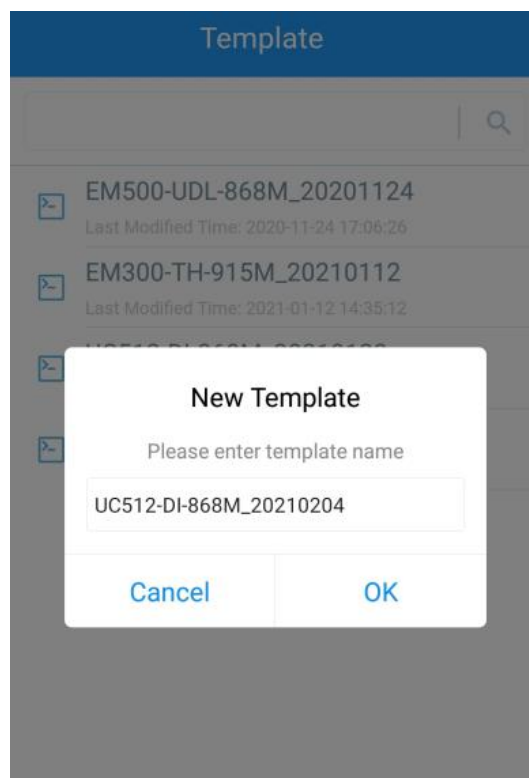

### 3.6.3 Reset to Factory Default

Please select one of following methods to reset device:

**Via Hardware:** Open the case of UC51x and hold on power button more than 10s.

**Via ToolBox Software:** Go to "**Maintenance -> Backup and Reset**" to click "Reset".

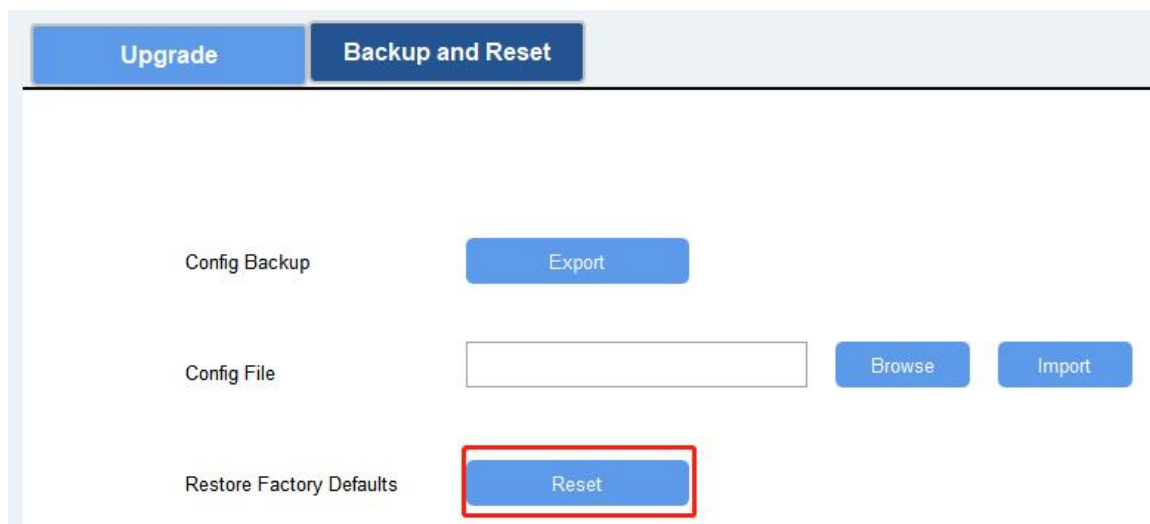

**Via Toolbox App:** Go to “**Device -> Maintenance**” to click “Reset”, then attach smart phone with NFC area to UC51x to complete reset.

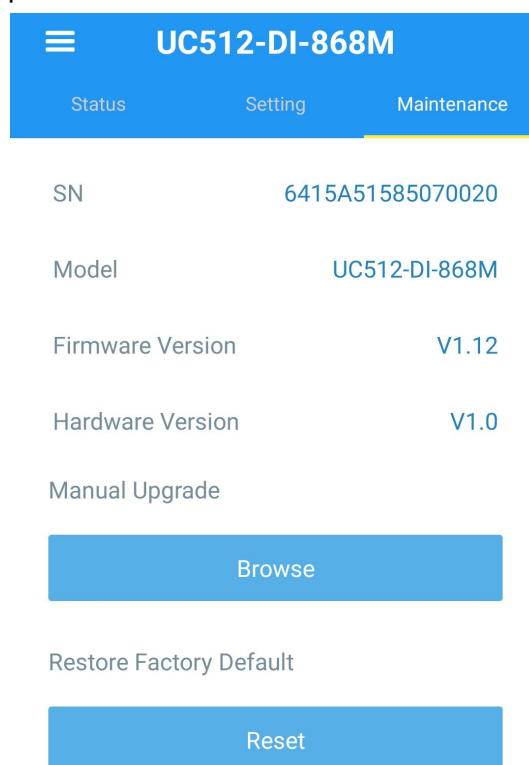

## 4. Installation

UC51x series support wall mounting or pole mounting. Before installation, make sure you have the mounting bracket, wall or pole mounting kits and other required tools.

### Wall Mounting:

1. Fix the wall plugs into the wall, then fix the mounting bracket to the wall plugs with screws.
2. Put the device on the mounting bracket, then fix the bottom of the device to the bracket with a fixing screw.

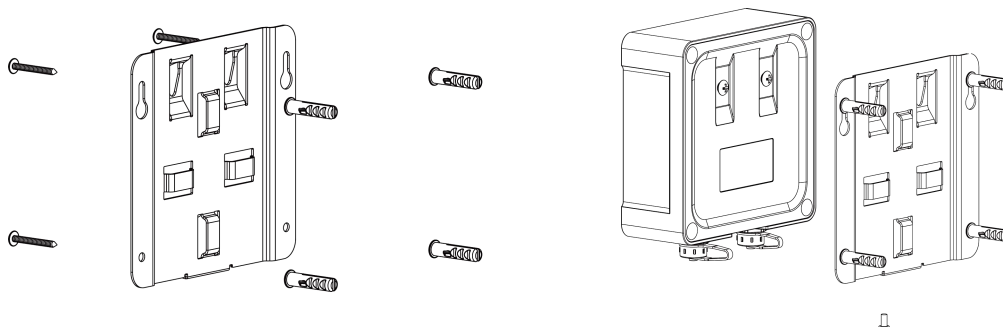

### Pole Mounting:

1. Straighten out the hose clamp and slide it through the rectangular rings in the mounting bracket, wrap the hose clamp around the pole. After that use a screwdriver to tighten the locking mechanism by turning it clockwise.
2. Put the device on the mounting bracket, then fix the bottom of the device to the bracket with a fixing screw.

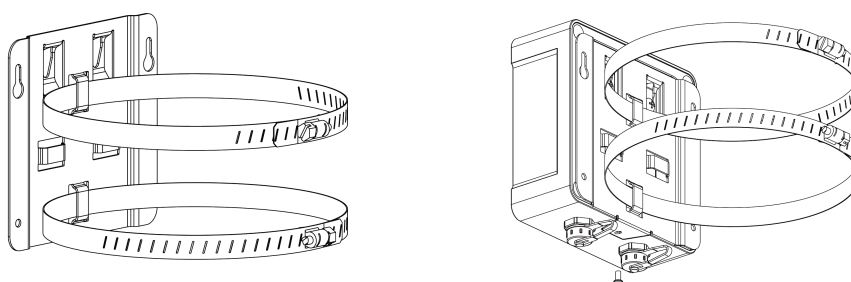

## 5. Milesight IoT Cloud Management

UC51x series can be managed by Milesight IoT Cloud platform. Milesight IoT cloud is a comprehensive platform that provides multiple services including device remote management and data visualization with the easiest operation procedures. Please register a Milesight IoT Cloud account before operating following steps.

### 5.1 Add UC51x to Cloud

1. Ensure Milesight LoRaWAN<sup>®</sup> gateway is online in Milesight IoT Cloud. For more info about connecting gateway to cloud please refer to gateway's user guide.

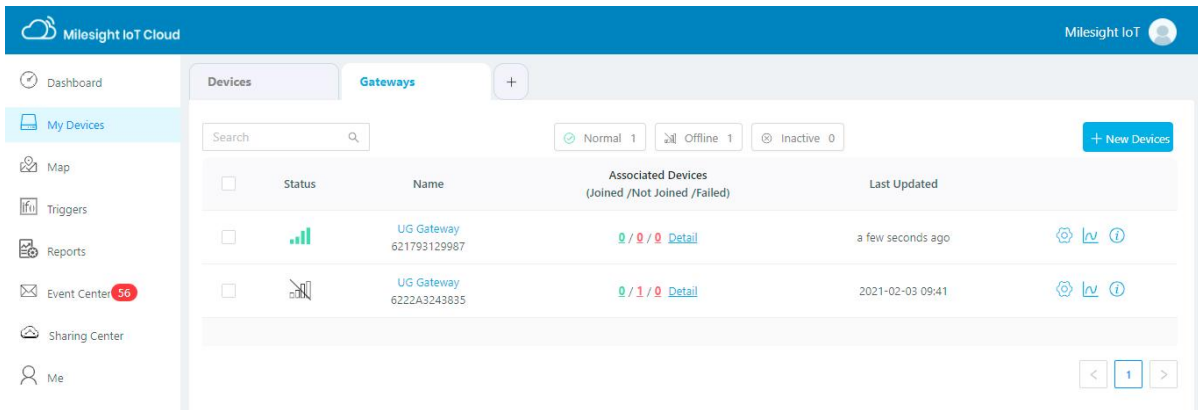

2. Go to “My Devices” page and click “+New Devices”. Fill in the SN of UC51x and select associated gateway.

**Add Device**

\* SN: 6415A51585070020

\* Name: UC511

\* Associated Gateway: UG Gateway

\* Device EUI: 24e124415A515850

\* Application Key: 5572404c696e6b4c6f52613230313823

Cancel Confirm

3. Click  and go to “Basic Settings” to change class type the same as device settings.

Devices / UC511 / Basic Settings

**Basic Settings** Interface Settings Maintenance Log Refresh Share

\* Name: UC511

\* Application Key: 5572404c696e6b4c6f52613230313823

LoRaWAN Class : classA

Class A: Downlink communications (configuration changes) from the Cloud at any other time will have to wait until the next scheduled uplink from devices.

Description:

Besides, configure the unit of per pulse if you connect the water meter.

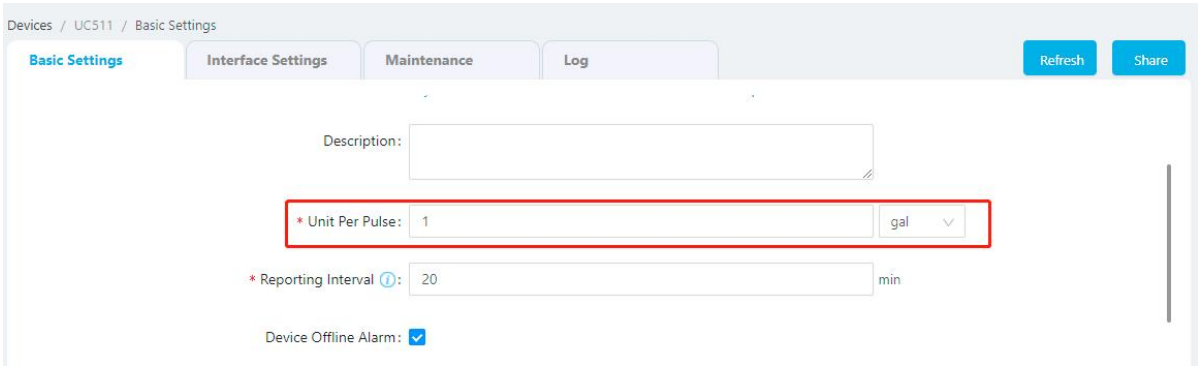

4. Click  and go to "Interface Settings" to select used interfaces and customize the name and thresholds.

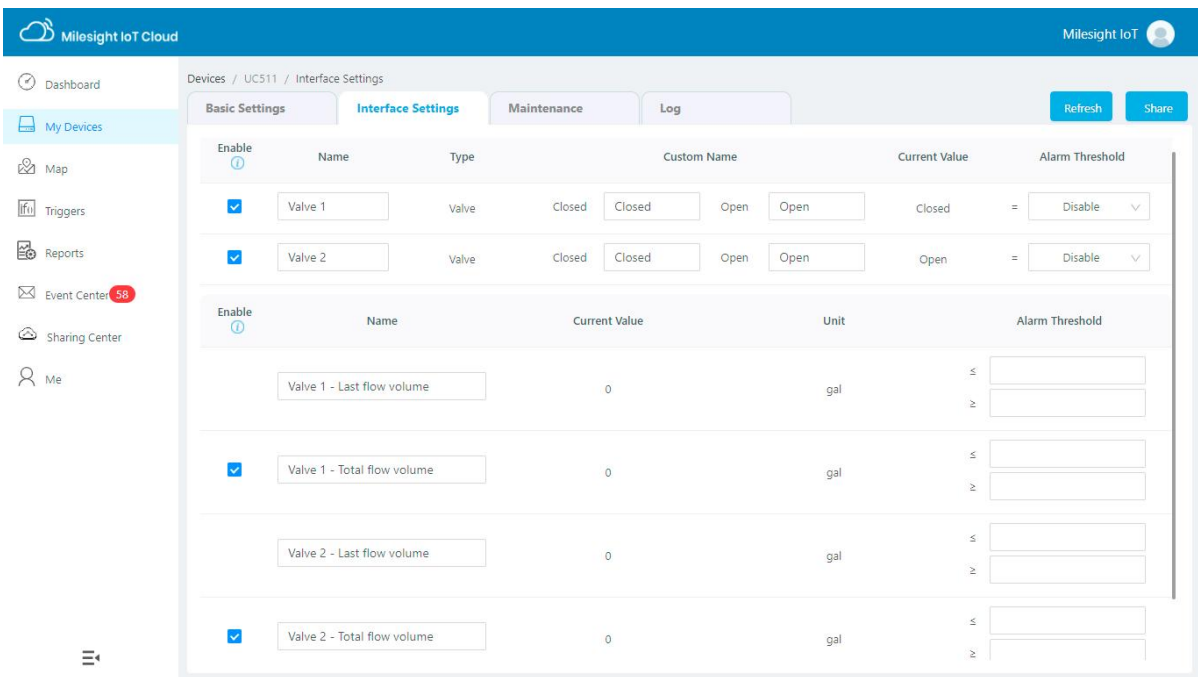

## 5.2 Solenoid Valve Control

Solenoid valve can be controlled by Milesight IoT cloud webpage or App.

1. Click  to open the solenoid valve and configure the duration. Note that if you enable any local plan on UC51x device, this control will not work.

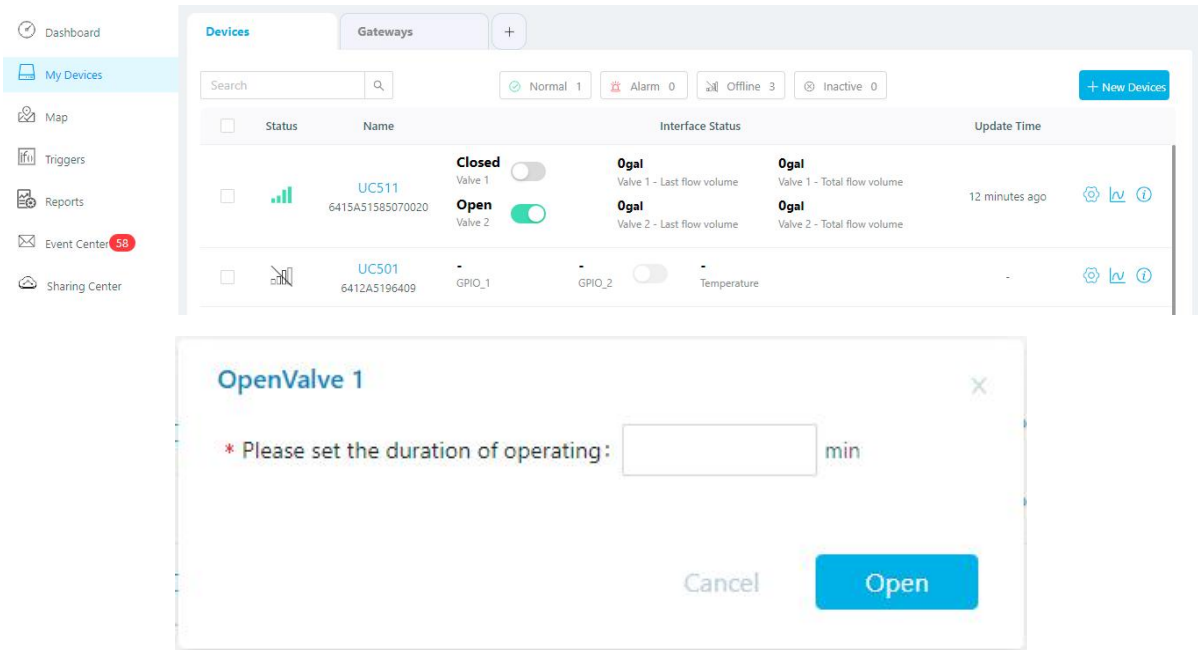

You can also add a switch on the dashboard to control the status of solenoid valves.

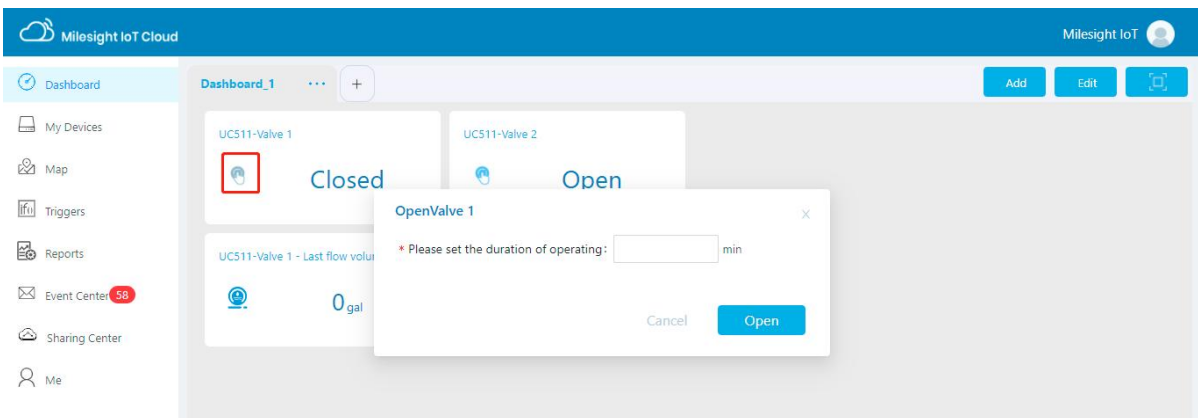

**Note:** If the working mode of UC51x is LoRaWAN® Class A, control commands will delay until the time icon disappears.

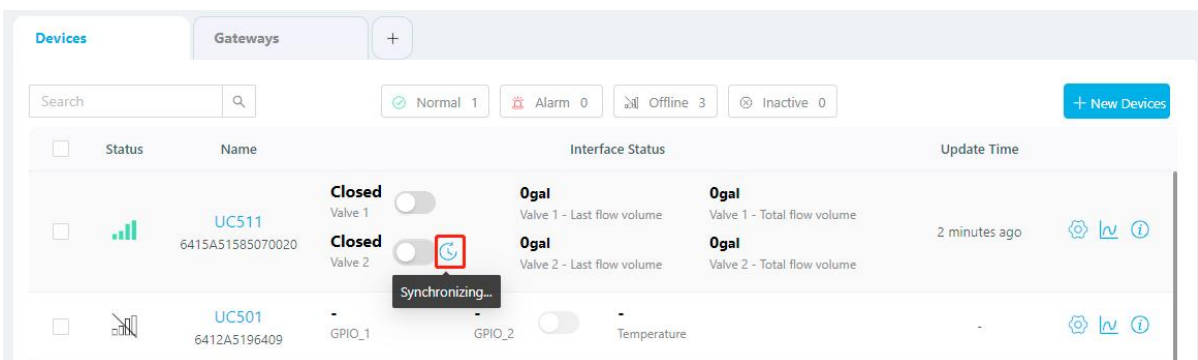

2. Go to "Triggers" page to add actions to trigger the solenoid valve to open for a period of time or a specific volume of water.

**Note:** Water volume control is only worked when you connect water meter to UC51x device.

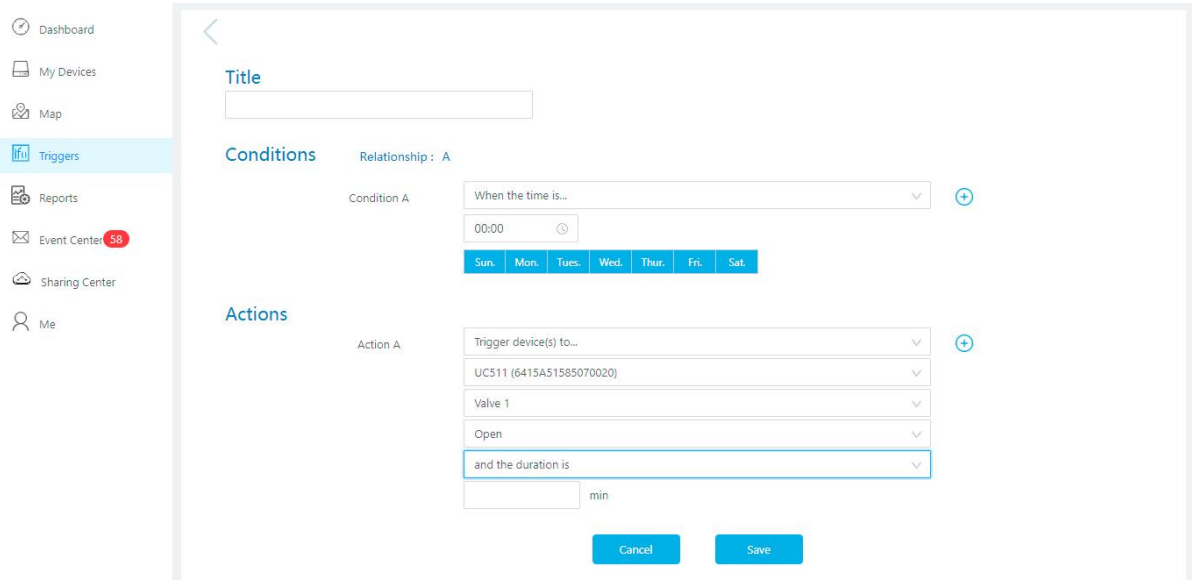

## 6. Device Payload

UC51x Series use the standard Milesight IoT payload format based on IPSO. Please refer to the **UC51x Series Communication Protocol**; for decoders of Milesight IoT products please click [here](#).

**-END-**