

Internal & External Compact Customer Connection Interface (CCI) Specification



Product Description

The Compact Customer Connection Interface (Compact CCI) developed by OPT Services, is a wall mounted fibre management enclosure suitable for any network infrastructure that uses optical fibre to deliver customer connectivity. It has been specifically designed to provide an aesthetically minimised footprint (121 x 104 x 29mm) for both universal Brownfield & Greenfield installation. It can be deployed internally or externally as required, with a specific version for each location. The module has a one piece cover that provides environmental protection and access to the internal components. When deployed internally a bespoke ONT mounting bracket can be fixed over the front cover which helps to minimise the installed footprint.

The unit is moulded and assembled in the UK.



This document is intended for guidance only. Whilst the information it contains is correct at the time of publication, OPT Services UK Limited reserves the right to make changes to this document without notice. This document is protected by copyright © OPT Services [2023]. The products depicted herewith are protected by intellectual property rights. Any unauthorised copying of this document or of our products is prohibited and OPT Services UK Limited will take action to prevent any infringement of its rights to claim damages for the loss that it suffers.

External Compact CCI Design Features

- The External Compact CCI is designed to mount on a wall using the existing Capping 101 fixing holes. It will interface with the standard Capping 25. All fixings are hidden within the enclosure
- A flexible ‘wiper’ seal is fitted between Backplate and wall for protection against moisture ingress.
- The Compact CCI provides a single cable input with four output cable options:
 - 2 x outside BT Capping 25
 - 1 x inside BT Capping 25
 - 1 x ‘Through the Backplate/wall’
- The enclosure supports both underground and overhead cable feeds
- The Compact CCI Front Cover is positively located using a moulded lug at the top and a single captive M3 x 8mm Panhead screw (with M3 Nylon retaining washer on the inside)
- This version is moulded in UV stable grey ASA to be an aesthetic match to Capping 101

Internal Compact CCI Design Features

- The internal version of the Compact CCI is identical to the external type except for colour and the omission of the Wiper seal
- When used internally, the Compact CCI is installed the same way as the external version
- Mounting holes are also present to allow installation on a standard electrical backbox
- The optional ONT Mount is a holder that clips securely to the internal Compact CCI
- This variant is moulded in Self-extinguishing white ABS to match internal power & light fixtures
- Moulded in ABS V0, self extinguishing plastic

Application Notes

Both versions of the Compact CCI can store up to 6m of fibre (OD of 900um) on the splice tray.

The unique compact splice tray can accommodate up to 4 x 5A splice protectors and is compatible with G652D fibre. When installed externally, it can be used as a network demarcation point.

Detailed installation instructions for all options are available from OPT Services or from a QR code on the packaging.



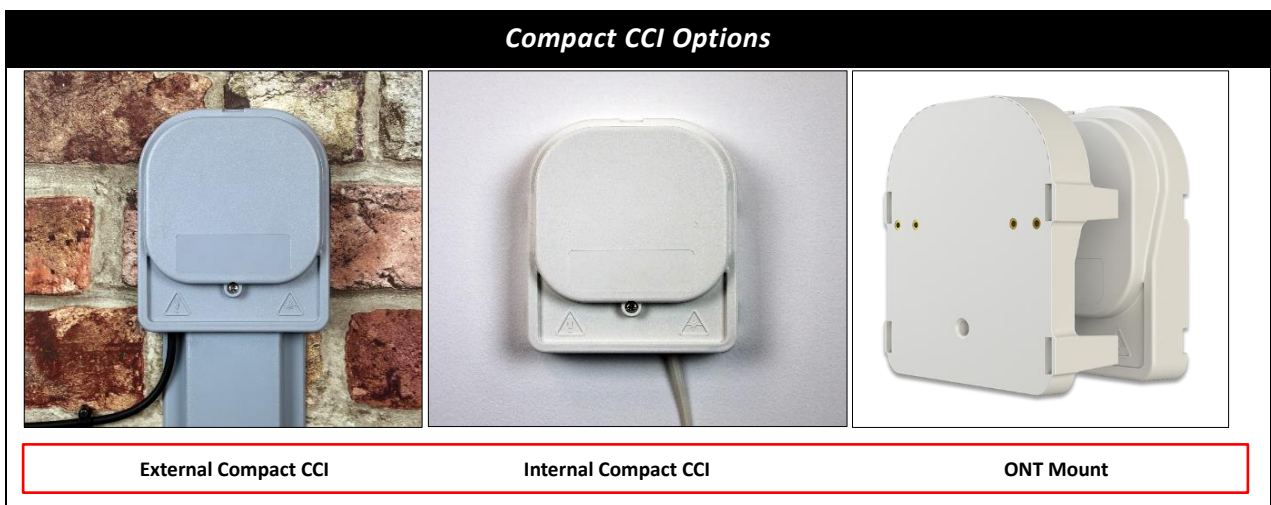







Your company logo can be applied to the front cover to suit requirements. Note there would be an additional charge associated with this option.





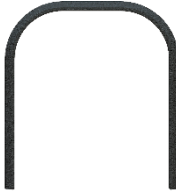

This document is intended for guidance only. Whilst the information it contains is correct at the time of publication, OPT Services UK Limited reserves the right to make changes to this document without notice. This document is protected by copyright © OPT Services [2023]. The products depicted herewith are protected by intellectual property rights. Any unauthorised copying of this document or of our products is prohibited and OPT Services UK Limited will take action to prevent any infringement of its rights to claim damages for the loss that it suffers.

Components & Part Numbers

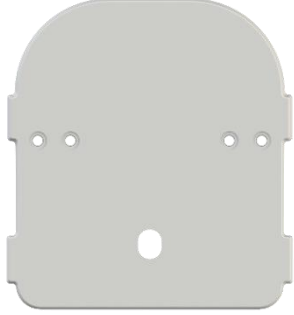
See Bill of Materials for further details

Compact Customer Connection Interface (CCCI) Main Component kits					
External (Grey) OPT-T0305			Internal (White) OPT-T0306		
					
Lid (1 off) <i>Includes seal and captive screw</i>	Backbox (1 off)	Split Seal (2 off)	Lid (1 off) <i>Includes seal and captive screw</i>	Backbox (1 off)	
					
Splice Tray (1 off)	Wiper Seal (1 off)	P-Clip (2 off)	P-Clip (1 off)	Splice Tray (1 off)	

Optional ONT Mount Component kit			
Internal (White) OPT-T0309			
			
ONT Mount (1 off)	Blanking Cap (2 off)	M3 Screw (2 off)	Pigtail

Part Number(s)	Description
OPT-T0305	External Compact CCI (non-branded)
OPT-T0306	Internal Compact CCI (non-branded)
OPT-T0309	Internal Compact CCI – Optional ONT Mount

This document is intended for guidance only. Whilst the information it contains is correct at the time of publication, OPT Services UK Limited reserves the right to make changes to this document without notice. This document is protected by copyright © OPT Services [2023]. The products depicted herewith are protected by intellectual property rights. Any unauthorised copying of this document or of our products is prohibited and OPT Services UK Limited will take action to prevent any infringement of its rights to claim damages for the loss that it suffers.

Dimensions

Compact CCI Dimensions

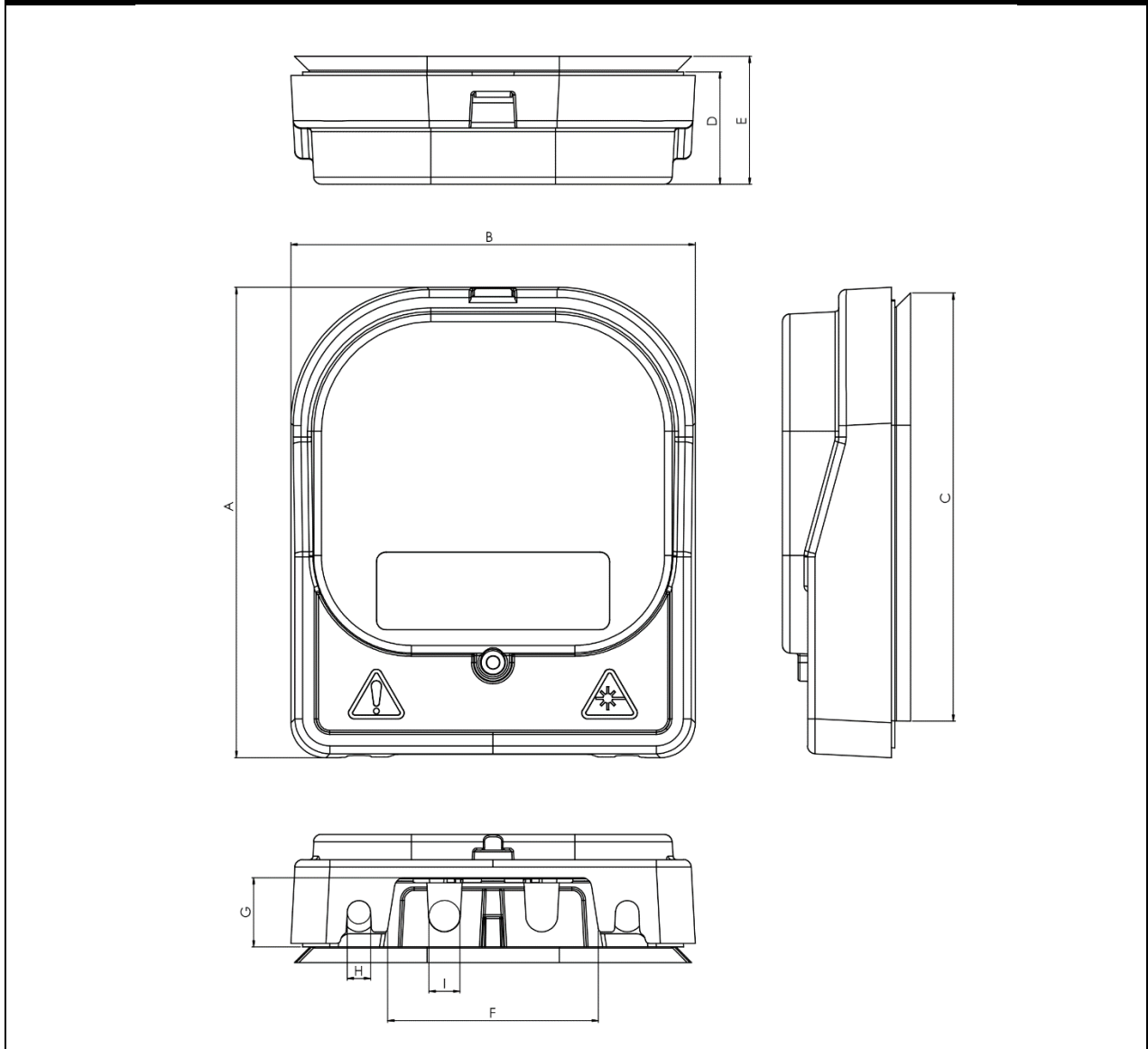

Letter	Description	Dimension
A	Footprint Length	121mm
B	Footprint Width	104mm
C	Wiper Seal Length	110mm
D	Footprint Depth (no Wiper Seal)	29mm
E	Footprint Depth (with Wiper Seal)	33mm
F	Capping 25 opening Width	54mm
G	Capping 25 opening Depth	18mm
H	Cable entry outside Capping 25	Ø6mm*
I	Cable entry inside Capping 25	Ø8mm*

*Diameter listed above is the moulded diameter not the maximum cable diameter supported

This document is intended for guidance only. Whilst the information it contains is correct at the time of publication, OPT Services UK Limited reserves the right to make changes to this document without notice. This document is protected by copyright © OPT Services [2023]. The products depicted herewith are protected by intellectual property rights. Any unauthorised copying of this document or of our products is prohibited and OPT Services UK Limited will take action to prevent any infringement of its rights to claim damages for the loss that it suffers.

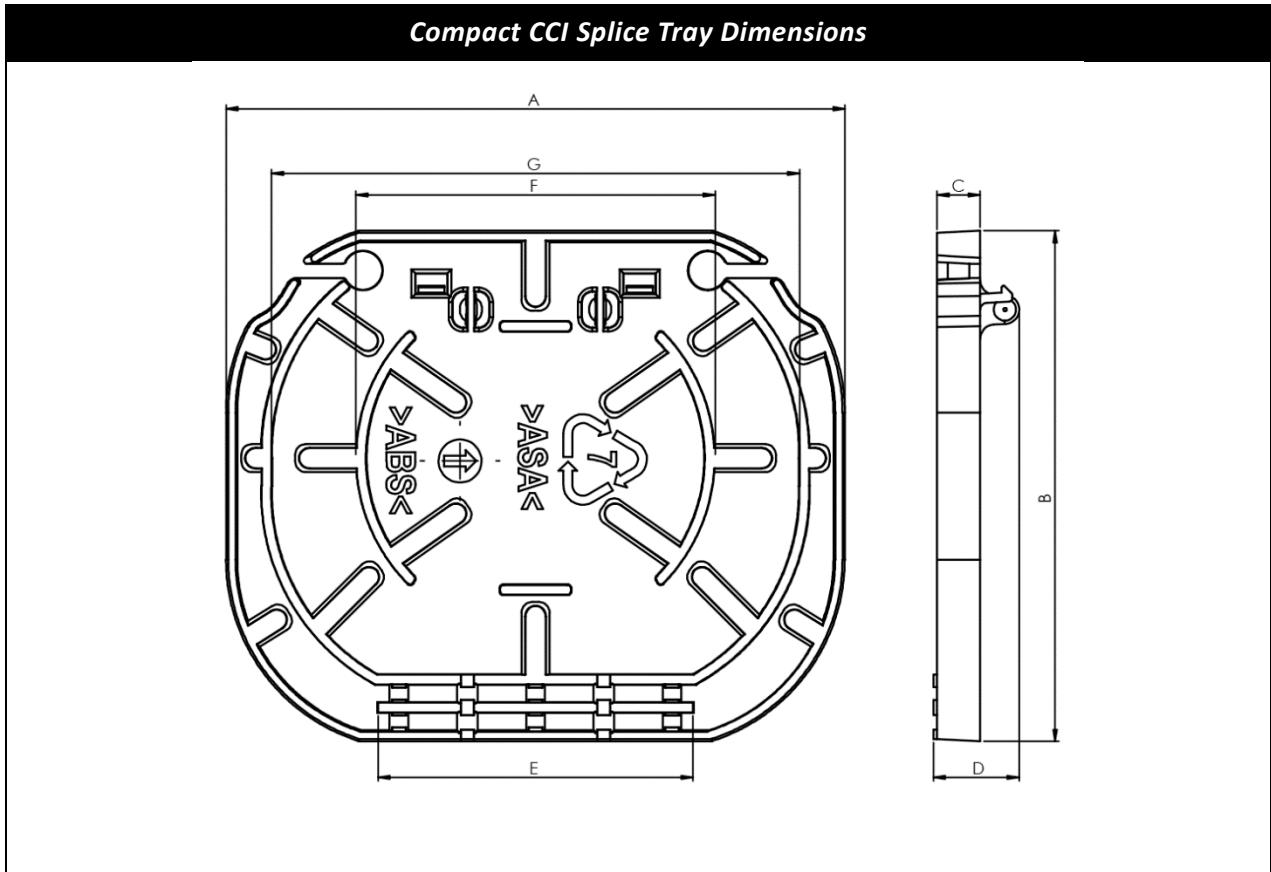

Letter	Description	Dimension
A	Footprint Length	86mm
B	Footprint Width	71mm
C	Tray Depth	6mm
D	Tray Depth with Hinge	12mm
E	Splice protector grip length	44mm
F	Inner Storage	Ø50mm
G	Outer Storage	73.5mm

Compact CCI ONT Mount Dimensions

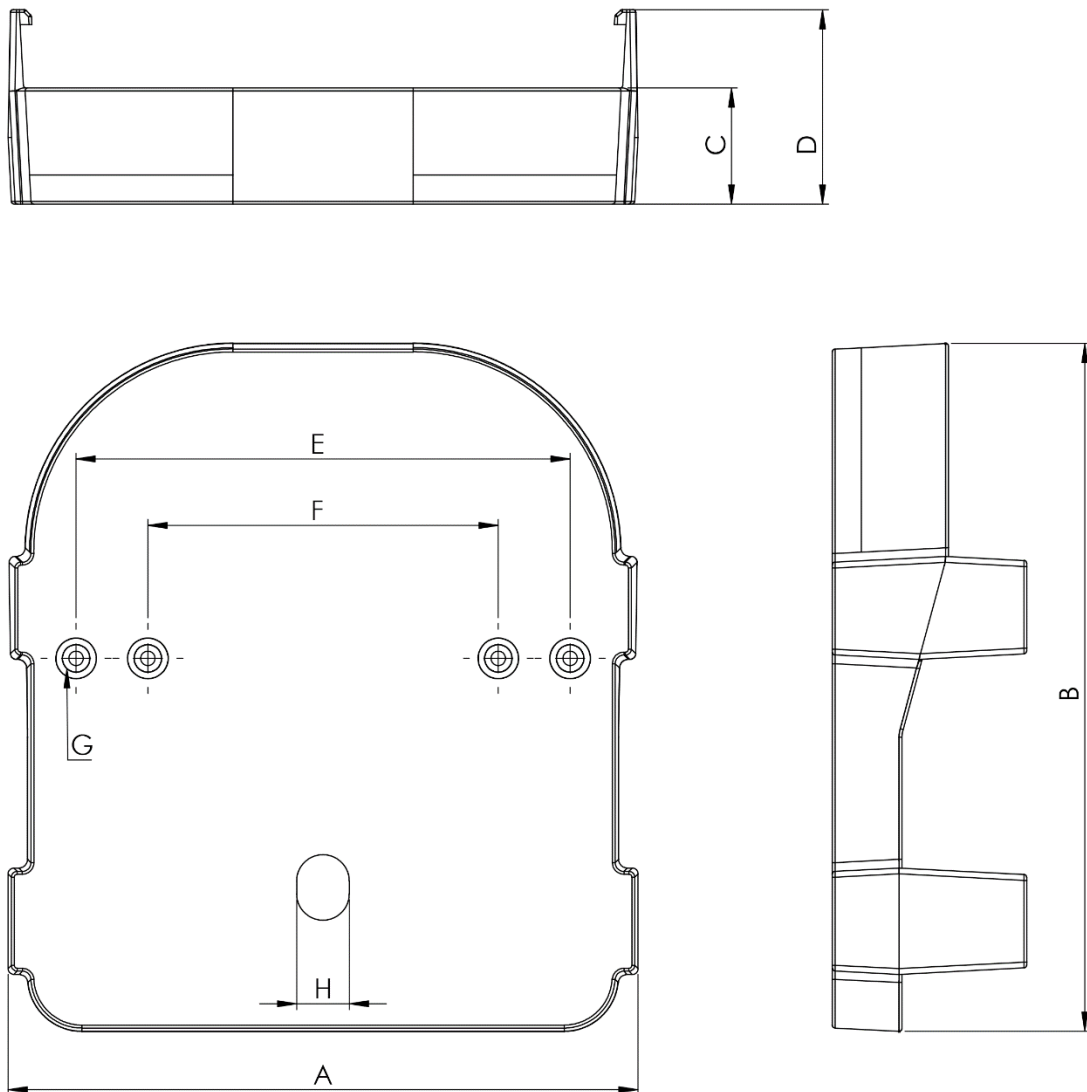

Letter	Description	Dimension
A	Footprint Length	108.5mm
B	Footprint Width	118mm
C	Footprint Depth	20mm
D	Footprint Depth with fixing clips	33.5mm
E	ONT fixing holes (between Centres)	85mm
F	ONT fixing holes (between Centres)	60.3mm*
G	Fixing hole diameter	M3 (x4 off)
H	CCCI Front panel access	9mm

* standard backbox hole centres

This document is intended for guidance only. Whilst the information it contains is correct at the time of publication, OPT Services UK Limited reserves the right to make changes to this document without notice. This document is protected by copyright © OPT Services [2023]. The products depicted herewith are protected by intellectual property rights. Any unauthorised copying of this document or of our products is prohibited and OPT Services UK Limited will take action to prevent any infringement of its rights to claim damages for the loss that it suffers.

Technical Details

Characteristic	
Installation Environment	Indoor or Outdoor (manufactured to suit)
Temperature Operating range	-25 to +75 °C
Maximum Cable diameter (in or out)	Ø 6.2mm anchored or Ø8mm unanchored*
Protection Rating	IEC 60529 - IP65
ONT Pigtail	SC/APC G657A2 3.0mm x 1M CCA standard grade jacket

* Anchoring the cable is the preferred method

Component	Colour	Material
External Compact CCI Backbox & Lid	Window Grey (RAL7040)	ASA
Internal Compact CCI Backbox & Lid	Pure White (RAL9010)	ABS V0 (Self-extinguishing)
Compact CCI Splice Tray	As above depending on use	As above depending on use
Compact CCI Backbox Ferrel	Gold	Brass
M3 Captive Screw (lid)	Silver	Steel
M3 Retaining Washer (lid)	White	Nylon
P-Clip	Black	ABS V0 (Self-extinguishing)
P-Clip Ferrel	Gold	Brass
P-Clip Screw	Silver	Steel
Split Seal	Black	TPE +4%Polypropylene (SR50)
Wiper Seal	Black	TPE +4%Polypropylene (SR50)
Lid Seal	Black	TPE +4%Polypropylene (SR50)
ONT Mount (& Blanking caps)	Pure White (RAL9010)	ABS V0 (Self-extinguishing)
ONT Mount M3 Ferrel	Gold	Brass
ONT Mount M3 x 8mm screw	Silver	Steel
ONT Pigtail	White	LSOH-FR PVC

All External surfaces of ASA or ABS moulded components have the commercial polish, light spark [30 VDI](#) finish applied. This is to reduce production marks and increase visual appeal and user grip.

Arrows moulded into the enclosure and splice tray indicate the type of plastic used for manufacturing, as shown below for the splice tray.

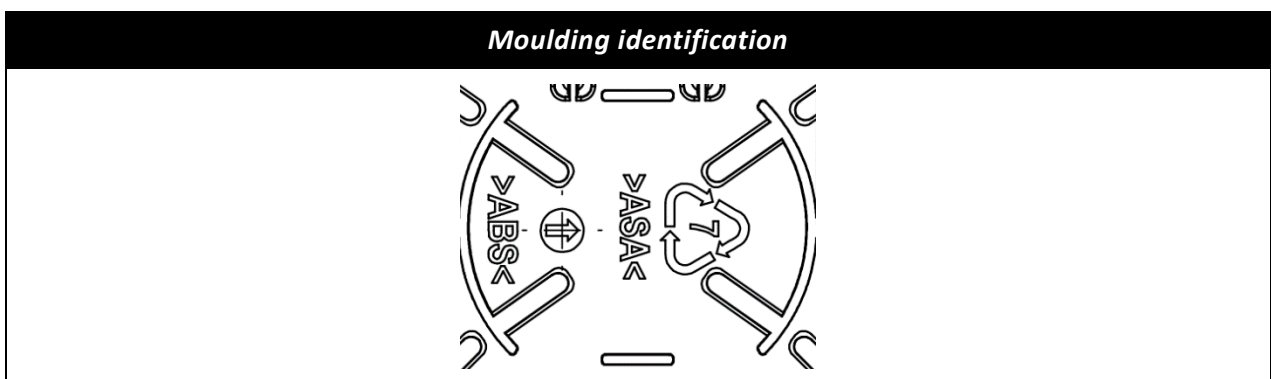

This document is intended for guidance only. Whilst the information it contains is correct at the time of publication, OPT Services UK Limited reserves the right to make changes to this document without notice. This document is protected by copyright © OPT Services [2023]. The products depicted herewith are protected by intellectual property rights. Any unauthorised copying of this document or of our products is prohibited and OPT Services UK Limited will take action to prevent any infringement of its rights to claim damages for the loss that it suffers.

Packaging & Labelling

All OPT Services products are dispatched in recyclable materials and clearly labelled with our name, product code and description where applicable. A QR-Code on the label can be used to access the on-line installation instructions, meaning they are readily available at all times.

OPT Services are accredited for Sustainable Packaging and documentation



Packaging H x W x D	Dimension
Height	135mm
Width	122.5mm
Depth	37mm
Thickness	1.5mm Cardboard

OPT Services are product specialists for fibre networks

<p>R&D Concept to Completion</p> <ul style="list-style-type: none"> • Over 130 years of Experience • Inhouse Prototyping • CNC & Injection Moulding • 3D Print Lab • 70+ Established Products 	<p>Services</p> <ul style="list-style-type: none"> • Cable Install & Assessment Site • Training Studio Facilities • Graphic Design • Assembly & Rework • Cable Winding 	<p>Logistics</p> <ul style="list-style-type: none"> • Storage & Delivery • 2800m² of floor space • 1700+ Pallet Spaces • PROSKU Management System • Fleet of Logistics Options
---	--	---

Call us with any queries: 01473 612188

This document is intended for guidance only. Whilst the information it contains is correct at the time of publication, OPT Services UK Limited reserves the right to make changes to this document without notice. This document is protected by copyright © OPT Services [2023]. The products depicted herewith are protected by intellectual property rights. Any unauthorised copying of this document or of our products is prohibited and OPT Services UK Limited will take action to prevent any infringement of its rights to claim damages for the loss that it suffers.

Appendix 1 - Abbreviations

Abbreviation	Explanation
ASA	Acrylonitrile Styrene Acrylate – weather resistant thermoplastic
ABS	Acrylonitrile Butadiene Styrene - heat-resistant thermoplastic
G625D	Specification for 10.1um rigid optical fibre with resistance to bending
IEC 60529	Standard that defines the IP code which classifies and rates environmental protection (intrusion, dust, accidental contact and water)
LSOH-FR	Low Smoke Zero Halogen – Flame Retardant
PVC	Polyvinyl Chloride - synthetic polymer of plastic
ONT	Optical Network Termination
RAL	RAL is a colour management system used in Europe
VDI	Verein Deutscher Ingenieure – scale of surface finishes

Appendix 2 - BoM

Description	Part Number	Volume - Internal	Volume - External
LID	OPT-01111	1 OFF	1 OFF
LID SEAL (Supply fitted)	OPT-01112	1 OFF	1 OFF
BACK BOX	OPT-01109	1 OFF	1 OFF
WIPER SEAL	OPT-01110	1 OFF	1 OFF
SPLICE TRAY	OPT-00810	1 OFF	1 OFF
SPLIT SEAL (bagged)	OPT-00812	N/A	2 OFF
P-CLIP (bagged)	OPT-00811	2 OFF	2 OFF
P-CLIP SCREW	M3 x 10 PAN	1 OFF	2 OFF
LID SCREW	M3 x 8 PAN	1 OFF	1 OFF
RETAINING WASHER	NYLON M3	1 OFF	1 OFF
INTERNAL FIXING SCREW	M3.5 x 25 C/S A2 OR BZP - POZI OR SLOT	2 OFF	N/A
EXTERNAL FIXING SCREW*	4.5 x 40 C/S POZI	N/A	N/A
RAWLPLUG*	UNO K 06	N/A	N/A
WRAPPER	OPT-01114	1 OFF	1 OFF
WRAPPER LABEL	OPT-01115	1 OFF	1 OFF
PALLET BOX LABEL	OPT-01118	1 OFF	1 OFF

* - items can be supplied when sold with branded enclosures

End of Specification

