

DMCC 2010-2011 Sponsors

Sponsor Categories	Firms
<i>Platinum</i>	
<i>Gold</i>	   
<i>Silver</i>	
<i>Resource</i>	  



Editors Note



Welcome Students,

The Duke MBA Consulting Club (“DMCC”) is proud to present the official 2010-2011 DMCC Case Book. This case book is the result of several years of development. We created this book to help you prepare for your upcoming consulting case interviews. As you may already know, case interviews are a very important part of the hiring process for consulting firms. These interviews give you the opportunity to showcase your communication, client, creative and analytical skills to your interviewer. This book was developed to complement the Duke MBA Consulting Roadmap curriculum. We hope that using both will help lead you to success during the upcoming recruiting season.

This case book could not have been completed without the valuable contributions of prior DMCC officers and our Executive Cabinet. We would like to thank personally everyone who helped to ensure this book came to fruition. We would also like to thank our friends at other MBA programs for sharing with us their old casebooks in order for us to continue to harvest new material.

Good luck with your preparation and remember that your fellow DMCC members are here to help! Please reach out to anyone on the cabinet if you feel that you are not “cracking the case”. Lastly, to the students of other top MBA programs using this case book during their preparation, we warmly welcome you to “Team Fuqua.”

Good luck!

Heather Higgins, Brian Kiefer & Kristin Yanulites

DMCC Class of 2011 Officers

www.fuquaconsulting.com

How to approach a consulting interview

The consulting interview process is fairly standardized across firms

	Duration	What to expect / What the interviewer expects	Evaluative Area
Introduction	<ul style="list-style-type: none"> • 1-2 min 	<ul style="list-style-type: none"> • This is your first chance to make an impression • Be enthusiastic, professional and confident 	<ul style="list-style-type: none"> • Overall personal presence, professionalism
Behavioral questions	<ul style="list-style-type: none"> • 5-10 min 	<ul style="list-style-type: none"> • Be prepared to “walk through your resume” • Be ready to answer questions about your experience without sounding rehearsed • They may ask you “Why consulting?” type questions 	<ul style="list-style-type: none"> • Teamwork ability • Leadership • Record of previous success
Case portion	<ul style="list-style-type: none"> • 30-35 min 	<ul style="list-style-type: none"> • The interviewer will tell you about a business problem and ask you to determine a solution • Be prepared to “think like a consultant” and clarify the problem while driving to specific recommendation 	<ul style="list-style-type: none"> • Problem solving abilities • Analytical skills • Ability to function under pressure

The case portion is a realistic representation of the work consulting companies do

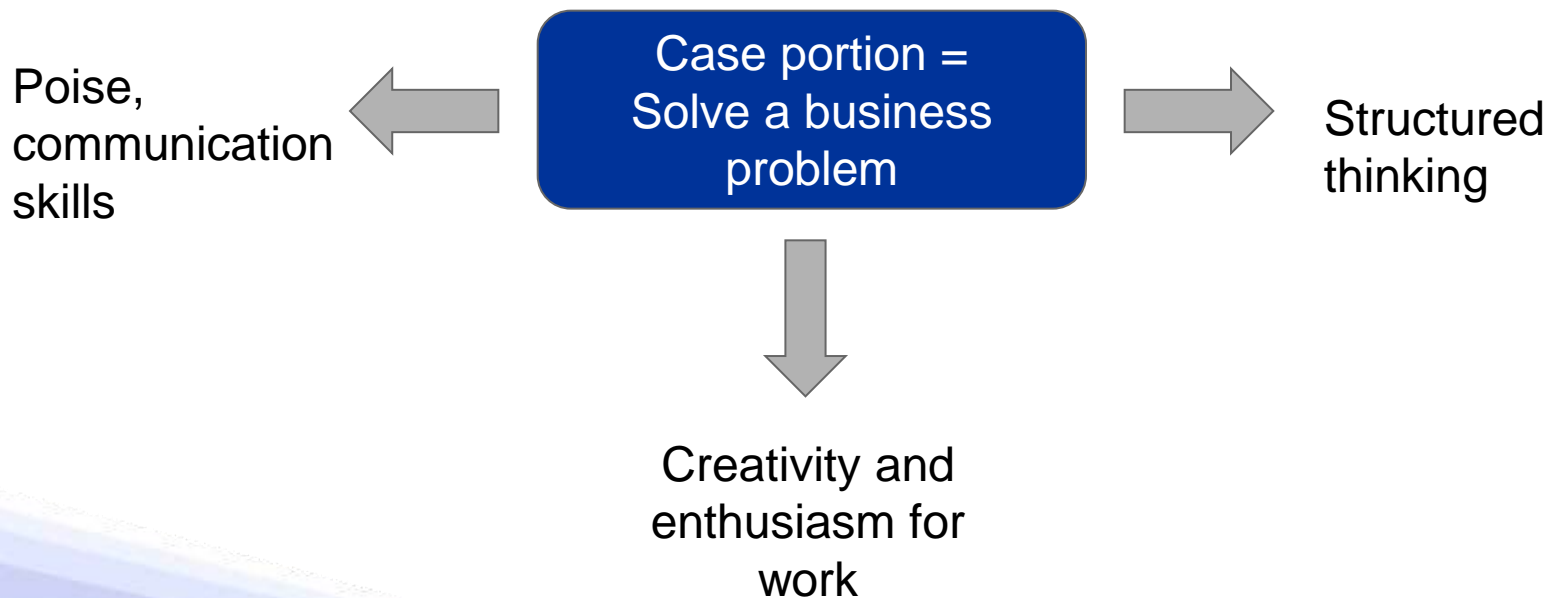

Similar to case work at consulting firms, cracking a case requires you to simplify an ambiguous problem into an easy to communicate recommendation

Strong candidates will be professional, enthusiastic, and analytical

Poise, communication

- Sit up straight
- Keep eye contact
- Maintain a professional presence
- Adapt to cues
- Speak up

Creativity/enthusiasm

- Have fun
- Don't appear like this is the worst experience of your life
- Show your creative side
- Don't be a "robot"

Structured thinking

- Don't shy away from numbers
- Use graphs
- Have a structured approach to your problem solving



Often, people focus exclusively on the analysis. A candidate's poise and enthusiasm is just as, if not more, important

The case interview process is fairly standardized across firms

Interview Stage	Duration	What to expect / What the interviewer expects
1 Case question introduction	1-2 min	<ul style="list-style-type: none"> The interviewer will tell you about the business problem and what your objective is You should be taking notes and ask clarifying questions to ensure you heard the question correctly before moving on
2 Structure creation / Approach development	1-2 min	<ul style="list-style-type: none"> This is where you lay out how you will solve the problem (Quiet time is expected here, but feel free to talk through your reasoning if you are comfortable) You will be expected to come up with an approach fairly quickly, but will be able to adjust throughout
3 Case Analysis	20-25 min	<ul style="list-style-type: none"> Expect to drive the case, focusing only on what is relevant and high impact Ask questions that will help you address your hypothesis
4 Case Summary / Recommendation	2-5 min	<ul style="list-style-type: none"> Summarize the case by giving a recommendation backed up by insights discovered in the case

Hammerjack is a regional chain of local hardware stores located in numerous neighborhood strip malls and shopping centers. They have enjoyed excellent performance for the past 15 years and have experienced declining profits in the past two years. They are concerned about their profitability and have hired you to explain their situation and provide recommendations to get them back on track.

The prompt will contain many details; be sure not to miss early hints

- 1.a) Our client, a manufacturer of lawn mowers, is considering selling lawn mowers in China
- 1.b) Our client, a manufacturer of lawn mowers, is considering manufacturing lawn mowers in China
- 2.a) Our client is looking for suggestions on how to increase sales of copper
- 2.b) Our client is looking for suggestions on how to increase sales of laptop computers



LISTEN to the prompt, and ask clarifying questions about any parts of the prompt that are unclear

Small differences will have a big impact on the case

1.a) Our client, a manufacturer of lawn mowers, is considering selling lawn mowers in China

External opportunity: revenue growth, market size, competitors, demand

1.b) Our client, a manufacturer of lawn mowers, is considering manufacturing lawn mowers in China

Internal opportunity: cost cutting, profit margins, quality issues

2.a) Our client is looking for suggestions on how to increase sales of copper

Undifferentiated product: pricing, customer expansion, market dynamics

2.b) Our client is looking for suggestions on how to increase sales of laptop computers

Differentiated product: new features, new segments, bundling



The topics will all be covered in future DMCC sessions

Hammerjack hardware: prompt dissection

Small, local player. How do they compare to Home Depot?

Retailer – let's look at number of customers & \$/visit

Are there other areas they could be in?

Hammerjack is a regional chain of local hardware stores located in numerous neighborhood strip malls and shopping centers. They have enjoyed excellent performance for the past 15 years and have experienced declining profits in the past two years. They are concerned about their profitability and have hired you to explain their situation and provide recommendations to get them back on track.

Profits = revenue - costs

Task: diagnose and suggest



Balance active listening w/ pre-planning

Candidates should use a hypothesis driven & M.E.C.E. approach to develop a structure

Hypothesis Driven Approach

- Establish a hypothesis/answer/hunch first
- Follow with the steps needed to assert whether the answer is true
- If constructed correctly, proving the hypothesis wrong should be just as valuable as proving it right
- *Our client should acquire company X ...*

M.E.C.E.

- Mutually Exclusive, Collectively Exhaustive
- Approaches should explore disparate areas (mutually exclusive) while covering all of the options (collectively exhaustive)
- Demonstrates a thorough/systematic approach to reviewing all of the options
- *... because the market for X has room for growth, the competitive landscape is not set, & X has a sustainable advantage (3 Cs)*



The best answers start with a hypothesis, and use a set of M.E.C.E. assertions to prove whether the hypothesis is true or not

Candidates should develop a “structure” to tackle the issue

Tree based

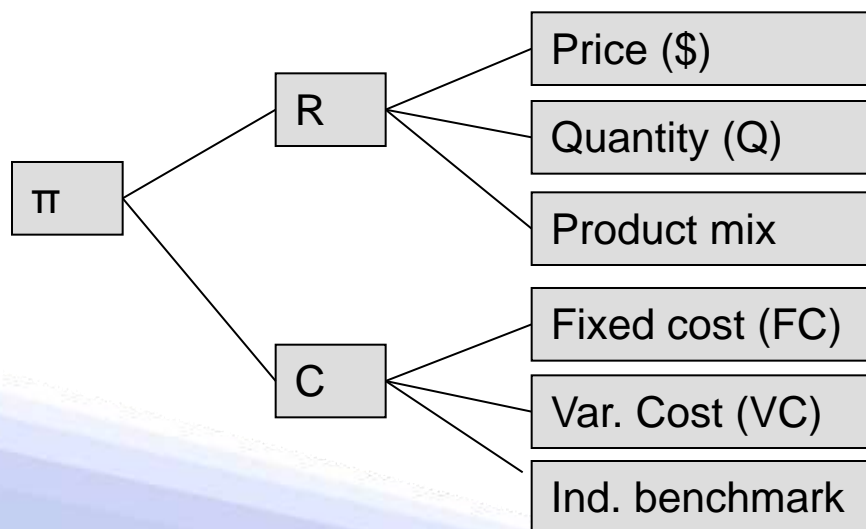

Descriptive

1. Cost – look at main FC & VC cost drivers
2. Revenue – examine pricing, sales levels, and product mix
3. New opportunities – acquisitions or JVs



Take the time to read some case books to find out what works for you

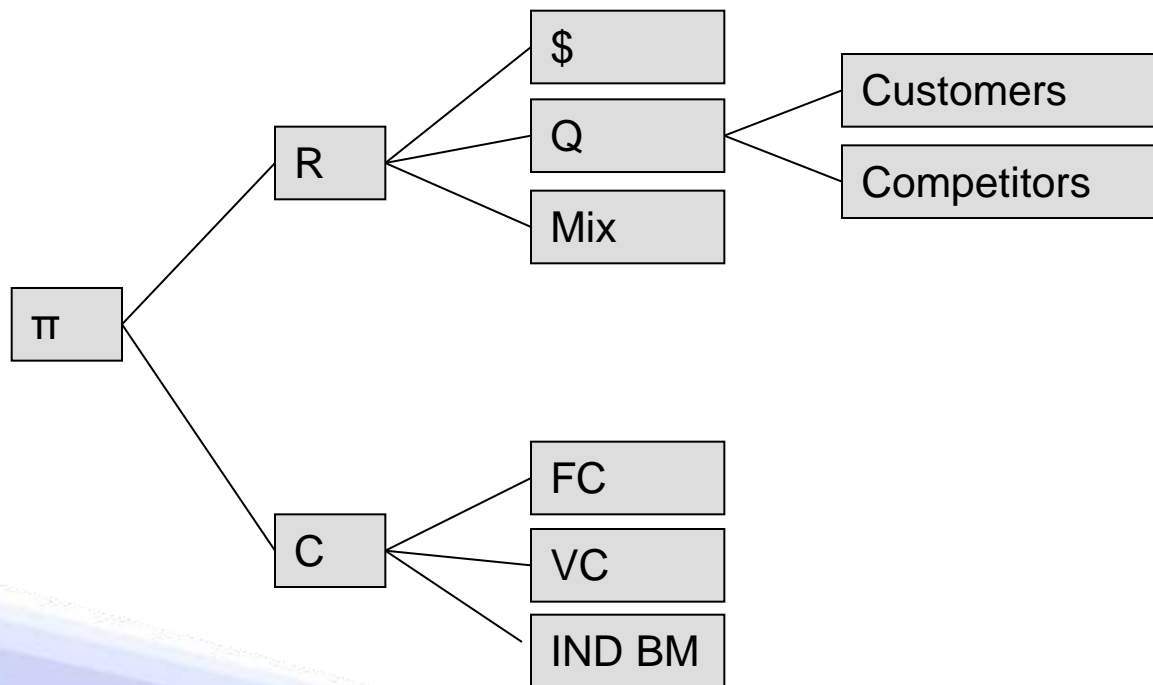

I'd like to examine Hammerjack's revenue and cost structure. While examining revenue I'd especially like to examine how our different types of customers and our competitors effect the total number of goods we're selling. When examining cost I'll be sure to look our fixed and variable costs and see if we have any information on the cost structure of similar companies.

Candidates should use a hypothesis driven & M.E.C.E. approach to develop a structure

3

Case Analysis

- Try to drive the analysis, but look for cues from the interviewer
- Use your framework!
- Use tables / graphs / diagrams to display complicated information

4

Summary / Recommendation

- Distill your summary/recs to a few sentences highlighting the most important findings
- Have a definite answer, don't hedge
- Refer to numbers/findings from the analysis
- If time permits, suggest a few areas for further exploration/review after you have given your recommendations

Conclusion:

Hammerjack's is losing revenue because the maintenance segment is going to big box retailers; however, we still have a loyal contractor segment because they only shop once a year

Recommendation:

I recommend that we offer training to improve our employees understanding of the local communities and work to align our products to our loyal contractor segment's needs

Beware of common behavioral and case interview pitfalls

Behavioral interview

- Not being prepared because of too much case focus
- Being vague/not specifying the impact
- Not discussing skills that support candidacy (i.e. core consulting competencies)
- Not having a good answer for “why consulting” & “what would you do if you couldn’t do consulting”

Case interview

- Not having a clear plan/structure (Probing for information without reason)
- Drilling too deep into unimportant information
- Not picking up on interviewer cues
- Getting lost in the numbers
- Being too rigid/structured/mechanical (i.e. not demonstrating that you can think on the spot)

CASES

Execution

- Structure 1 2 3 4 5
 ➤Logical approach Comments:
 ➤MECE
 ➤Appropriate drive to solution

- Quantitative Ability 1 2 3 4 5
 ➤Speed Comments:
 ➤Accuracy
 ➤Comfort, reaction to mistakes

- Business intuition 1 2 3 4 5
 ➤Practical Comments:
 ➤Insightful
 ➤Breadth & depth across multiple functions
 ➤Creativity

Communication

- Professionalism 1 2 3 4 5
 ➤Poise Comments:
 ➤Confident-Persuasive
 ➤Articulate-concise
 ➤Client ready

- Written 1 2 3 4 5
 ➤Clarity of writing and page layout Comments:
 ➤Ability to refer back
 ➤Comfort, reaction to mistakes

Behavioral (optional)

- Quality of star stories 1 2 3 4 5 Comments:
- Length 1 2 3 4 5
- Clarity 1 2 3 4 5
- Relevance 1 2 3 4 5

Case start time ____:____

Framework development _____ min
 Framework explanation _____ min
 Case discussion _____ min

Case end time ____:____

Overall Rating: 1 2 3 4 5

Strengths

Weaknesses

Key: 1=Bottom 10%, 2= 10th-25th percentile,
 3= middle 50%, 4= 75th-90th percentile, 5=Top
 10%

Case Material Table of Contents:



Case #	Genre	Name	Page
1	Accounting	Southwright Medical Devices	41
2	Market Sizing	Polly Publishing	45
3	Market Sizing	Japanese Golf Balls	47
4	Market Sizing	Disposable Diapers	48
5	Market Sizing	Chewing Gum	50
6	Valuation	Scotch Bar	53
7	Valuation	Chemical Brothers International	57
8	Valuation	Internet Portal Evaluation	62
9	Valuation	Cinemas	65
10	Profitability	Slick Hick Farm Equipment	69
11	Profitability	Nabisco's Market Share	72
12	Profitability	Sgt. Slaughter	76
13	Profitability	Bank Commissions	83
14	Profitability	Electronics Co.	86
15	Profitability	Convenience Store	92
16	Profitability	Office Products	102
17	Profitability	Euro Seafood	106
18	Human Capital	KGF's Learning Management	113
19	Human Capital	Strugandt and Losen merger	115
20	Human Capital	Edoceo	117
21	Human Capital	Smith Financial CRM	120
22	Human Capital	F2D Electronics	123
23	Human Capital	Sunique Human Capital	126
24	Market Entry	Professional Car Racing	129
25	Market Entry	Lizette's Luxury Properties	136
26	Market Entry	Napoleon's Pizza	141
27	Market Entry	K Grace Hospital Chain	146
28	Market Entry	Stew's Connections	150
29	Market Entry	One for the Road	156
30	Market Entry	DMB Satellite	161

ACCOUNTING

Case 1: Southwright Med Device

Accounting

Deloitte

Unknown round

<p>Prompt</p>	<p>A medical equipment manufacturer in the southeastern U.S. has called you in because it feels its working capital requirements are much higher than those of its competitors. How will you help it solve its problem?</p>
<p>Guidance</p>	<p><i>This is a financial accounting case focused on a medical device company. The discussion should be conversational but exacting on details. There are no handouts so the candidate should rely on the general data given/created by the interviewer. The basic objective of this case is to test knowledge of the Balance Sheet and how it applies to business operations.</i></p> <p><i>Read this information well before you administer the case. Manage the case discussion and allow the candidate to formulate a plan based on the assumptions and key evidence provided below (case-specific). Offer prompts when necessary and provide the following information if he/she responds correctly and directly to the stimulus offered.</i></p> <p>CA & CL: <i>Let the candidate identify the need of Current Assets (CA) and Current Liabilities (CL). Provide this information on request: “Current assets consist of cash, inventory, and accounts receivable and current liabilities consist of accounts payable and short term debts.”</i></p> <p>Company: <i>Provide this information if the candidate asks for the background of the company: The company is made up of three divisions. The high inventory problem can be traced to a division acquired by the client about two years ago. The division manufactures equipment for arthroscopic surgery, namely capital equipment and blades which sell are similar to razors and razor blades, just much more sophisticated and expensive.</i></p> <p>Inventory: <i>If the candidate asks about inventory and indicates that the inventory could be very high, prompt him/her to discuss possible reasons for inventories to be high.</i></p> <p><i>An ideal answer would consist of: sales, poor forecasting, obsolescence.</i></p>

Case 1: Southwright Med Device

Accounting

Deloitte

Unknown round

<p>Guidance</p>	<p><i>If the candidate asks for the reasons for inventory problem, explain to the candidate that technology has been changing rapidly and the rate of obsolescence is extremely high. As earlier sales forecasts (shortly after the acquisition) had been overly optimistic, the client now finds itself loaded with obsolescent finished goods inventory. Then ask the candidate to recommend correction actions to remedy the problem.</i></p> <p><i>An ideal recommendation should touch upon these points:</i></p> <ul style="list-style-type: none"> ▪ <i>Determine appropriate levels of inventory such that excess inventory is reduced and customer demands are met.</i> ▪ <i>Factors that should be considered - Product demand, manufacturing lead times, customer expectations on order lead times.</i>
<p>Prompt – Part II</p>	<p>The client has 2.5 years of capital equipment finished goods inventory while NONE needs to be carried since these items can be manufactured after receiving the order (i.e. The finished good product is no longer sold.) What are the next steps?</p>
<p>Guidance</p>	<p><i>An ideal answer would look like this:</i></p> <p><i>With respect to technology, while certain aspects of the product may have changed substantially, other are just as likely to have stayed similar to what was previously used and could be salvaged. One could dismantle the product and reuse parts to manufacture the new devices. Selling off the inventory to distributors in less advanced healthcare markets is another way to salvage some of the investment. Alternately write off the non salvageable component parts.</i></p> <p><i>Once the candidate provide satisfactory answer, ask to wrap up.</i></p>

Case 1: Southwright Med Device

Accounting

Deloitte

Unknown round

<p>Performance Evaluation</p>	<p>Expected: The candidate clearly identifies the importance of CA & CL and explores each of these two further. The candidate asks questions regarding company and indentifies Inventory as a problem. After the candidate gets the information on inventory problem, he/she recommends some corrective actions. The candidate is also able to recommend next steps for prompt2.</p> <p>Good: The candidate not only performs the analysis in a methodical way identifying all major items but his/her recommendations also are very close to the ones stated earlier. The candidate does not need more than couple of prompts in pointing out all factors and reaching a conclusion.</p> <p>Excellent: The candidate identifies CA/CL early on and explains all possible elements under CA/CL and their relevance to the problem. The candidate is also able to quickly identify the problem with the inventory and explores all possible reasons for the problem in a very structured way. The candidate's recommendations on corrective actions and next steps are spot on.</p>
--------------------------------------	---

MARKET SIZE ESTIMATION

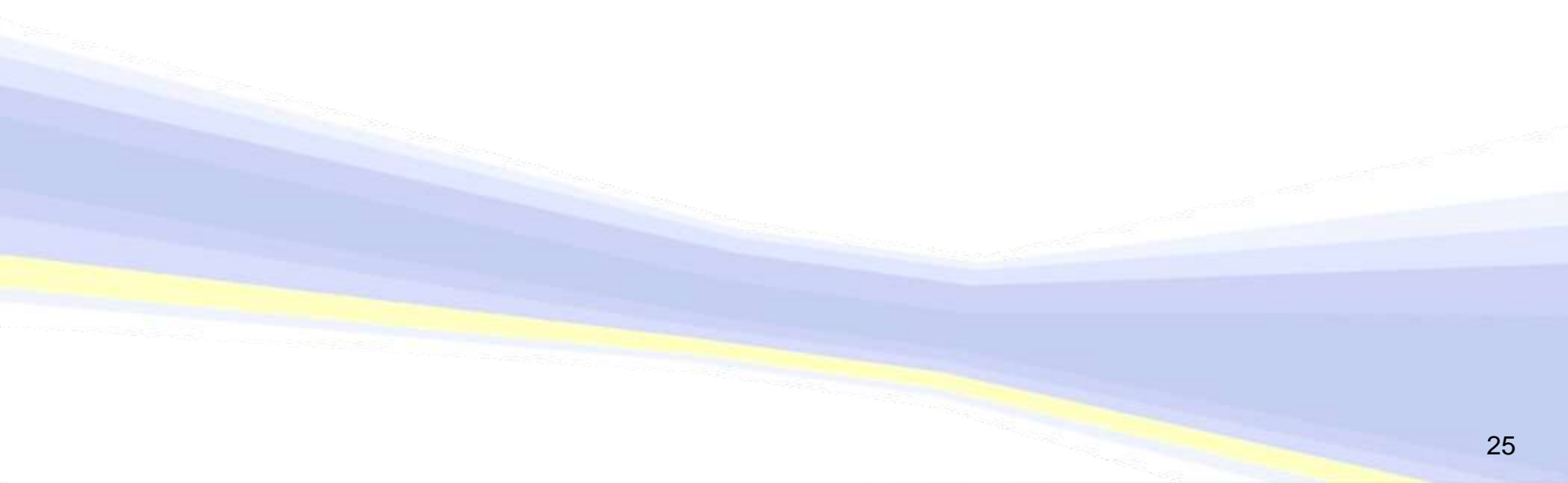

Case 2: Polly Publishing

Market Size Estimation

DMCC

Unknown round

<p>Prompt</p>	<p>Your client is the CEO of a publishing company producing a line of educational magazines and a line of women's magazines. Both businesses are profitable but not growing quickly. He wants to start a third monthly magazine in the US targeted at 25- to 55-year-old men (e.g. GQ Magazine). His stated goal is \$12 million in circulation revenues in the first year. Is this possible?</p>
<p>Guidance</p>	<p><i>This is a market estimation case. The case is based off estimations and the candidate's ability to work with those estimations. While there are no right/wrong answers in market estimation cases, the interviewer usually has a range of 'correctness', if you will. The candidate's answer should fall within interviewer's estimate to the extent that your assumptions are realistic.</i></p> <p><i>Ask the candidate to walk you through his thought process – top-down, bottom-up. Once his /her structure is in place, ask him/her to compute the calculation. Various methods may be used to estimate the answer; one approach is outlined below.</i></p>
<p>Analysis</p>	<p>Provide these information on request:</p> <ul style="list-style-type: none"> ▪ The total US population is approximately 300 million. ▪ Based on a normal distribution with the average life span of 80 years, approximately 1/2 of the population falls between 25-55, or about 150 million people. ▪ Approximately 1/2 of them are male, or 75 million. ▪ Of the 75 million 25- to 55-year-old men in the country, assume that at least 1/2 would read a magazine or ~40 million. ▪ Given the wide range of magazines on the market assume that only 10% of magazine readers would want to read a men's journal, or 4 million target customers. ▪ As a new magazine assume that you can generate a 5% share of the men's magazine market in year one, or 200,000 customers. ▪ Based on other magazines selling for \$2.50-\$5.00, assume a cover price of \$4/magazine at the newsstand and \$2/magazine for a subscription. ▪ Now make some assumptions on how many customers will buy at the newsstand versus subscription: assume 50% subscribe (100,000 customers) and 50% buy at the newsstand (100,000 customers).

Case 2: Polly Publishing

Market Size Estimation

DMCC

Unknown round

<p>Analysis</p>	<p>Monthly revenues amount to \$200,000 (subscription) + \$400,000 (newsstand) = \$600,000.</p> <p>For simplicity assume that all target customers buy a magazine every month.</p> <p>This would generate total annual revenues of \$600,000 X 12 or \$7.2 million.</p> <p>Conclusion: In this case, given the CEO's stated goal of \$12 million in circulation revenues, it does not make good business sense to launch the magazine.</p>
<p>Performance Evaluation</p>	<p>Expected: The candidate recognizes that this is a market estimation case and makes the appropriate assumptions and proceeds in a logical and structured way.</p> <p>Good: The candidate has a good plan to tackle the problem. The candidate explains his/her plans at the start and provides reasoning behind the approach. The candidate's assumptions are realistic and the candidate reaches some conclusion.</p> <p>Excellent: Apart from the criteria above, the candidate also reaches a very sound conclusion based on the data unearthed. The candidate's assumptions and estimations are very realistic and the candidate is quick in identifying all the elements of the problem. The candidate proceeds with the assumptions in the right direction and estimates the market size without any prompts from the interviewer.</p>

Case 3: Japanese Golf Ball Market

Market Estimation

DMCC

Unknown Round

<p>Prompt</p>	<p>You are going to visit a client who sells golf balls in Japan. Having had no time for background research, you sit on the plane wondering about the size of the market for golf balls in Japan, and what drives demand. Your plane lands in fifteen minutes. How do you answer these questions?</p>
<p>Guidance</p>	<p><u>There is no one right answer.</u> <i>The purpose of this exercise is to measure the candidate's ability to think logically.</i></p> <p><i>If the candidate struggle, encourage her outline a general framework for how she is going to solve the problem, and then come up with reasonable assumptions about the inputs that she needs. A good rule of thumb is to encourage the candidate to use round numbers.</i></p>
<p>Analysis</p>	<p>If asked, the population of Japan is 125 million.</p> <p><u>There is no one right answer.</u> <i>The analysis below is an example. The candidate should make reasonable assumptions (ask for logic behind assumption) to arrive at the answer.</i></p> <p>Proportion that play golf: 1/5. Purchase Frequency: the average golfer plays 20 times per year and uses four balls per time. $125 * 1/5 * 20 * 4 = 2,000$ million. The estimated market size for golf balls in Japan is 2 billion.</p>
<p>Performance Evaluation</p>	<p>Expected: The candidate will use a logical linear thought process to arrive at a market size and recognized the golf ball sales are driven by end user demand. The candidate will demonstrate confidence in his logical thought process.</p> <p>Good: The candidate is able to point out specific weaknesses in his approach and how those would affect his answer.</p> <p>Excellent: The candidate will show poise and confidence and quick business intuition . He will also recognize other potential drivers of demand such as golf course needs, business advertising, etc.</p>

Case 4: Disposable Diapers

Market Estimation

DMCC

Round 1

<p>Prompt</p>	<p>You have been retained jointly by Pampers and a federal commission on waste management. They would like you to estimate the volume percentage of disposable diapers in the total US household garbage.</p>
<p>Guidance</p>	<p><i>This is a market sizing case. The case is based off estimations and the candidate's ability to work with those estimations. While there are no right/wrong answers in market estimation cases, the interviewer usually has a range of 'correctness', if you will. The answer should fall within interviewer's estimate to the extent that assumptions made are realistic. The interviewer is looking for a logical approach and structure to the candidate's problem-solving skills. Ask the candidate to walk you through his thought process – top-down, bottom-up. Once his/her structure is in place, ask him/her to compute the calculation. Various methods may be used to estimate the answer; one approach is outlined below.</i></p>
<p>Analysis</p>	<p><i>The following is all generated by the interviewee, not from the interviewer:</i></p> <p>Volume percentage = Diapers (volume) / US household garbage (volume)</p> <p>Numerator</p> <ul style="list-style-type: none"> ▪ Population of the United States: 300 million ▪ Proportion of population that are disposable diaper-wearing children: 10% = 30 million ▪ Number of diapers used per day: 4 = 120 million diapers per day. ▪ Volume per diaper: 500 mL (or use another number in gallons/oz if you prefer) ▪ Volume thrown away per day = 500mL * 120 million = 60,000 million mL = 60 million liters <p>Denominator</p> <ul style="list-style-type: none"> ▪ Population of the United States: 300 million ▪ Average volume of household garbage can: 10 liters (or use gallons if preferred) ▪ Average number of emptied bags per day: 1 = 10 liters per day ▪ Total volume of garbage/day: 300M * 10L = 3,000 million liters <p>Ratio</p> <ul style="list-style-type: none"> ▪ 60 million liters of diapers/ 3,000 million liters of garbage = 2%

Case 4: Disposable Diapers

Market Estimation

DMCC

Round 1

<p>Performance Evaluation</p>	<p>Expected: Candidate will develop a structured approach to finding a solution. Assumptions will be clarified and based on reasonable logic.</p> <p>Good: Candidate will use numbers or round appropriately to simplify calculations.</p> <p>Excellent: In addition to the above, the candidate will evaluate his/her final number and provide explanation as to how changes to assumptions would affect the estimation.</p>
--------------------------------------	--

Case 5: Chewing Gum

Market Estimation

DMCC

Unknown Round

Prompt	How would you estimate the size of the annual U.S chewing gum market?
Guidance	<p><i>This is a market sizing case. The case is based off estimations and the candidate's ability to work with those estimations. While there are no right/wrong answers in market estimation cases, the interviewer usually has a range of 'correctness', if you will. The answer should fall within interviewer's estimate to the extent that assumptions made are realistic.</i></p> <p><i>The interviewer is looking for a logical approach and structure to the candidate's problem-solving skills. Ask the candidate to walk you through his thought process – top-down, bottom-up. Once his/her structure is in place, ask him/her to compute the calculation. Various methods may be used to estimate the answer; one approach is outlined below.</i></p>
Analysis	<p><i>The following is all generated by the interviewee, not from the interviewer:</i></p> <ul style="list-style-type: none"> ▪ Population of the US: 300 million ▪ The heaviest users are between the ages of 10-20. They comprise roughly 20% of the population, or 60 million. ▪ Estimate that these people chew two packs per week. Estimate number of packs/year: 2 packs/week * 60 million people * 50 weeks = 6,000 million packs. ▪ For all other users, (80% of 300 million population, or 240 million) estimate a usage rate of one half pack per week: 0.5 packs/week * 240 million people * 50 weeks = 6,000 million packs. ▪ Adding these two figures, estimate the total chewing gum market to be 6,000 + 6,000 = 12,000 million (or 12 billion) packs per year. ▪ Now check for reasonableness. We have the volume, what about the revenue? How much is 12,000 million packs in terms of dollar sales? Estimate for average price of pack: \$0.75. 12 billion packs * .75 = \$9 billion

Case 5: Chewing Gum

Market Estimation

DMCC

Unknown Round

<p>Performance Evaluation</p>	<p>Expected: Candidate will develop a structured approach to finding a solution. Assumptions will be clarified and based on reasonable logic.</p> <p>Good: Candidate will use numbers or round appropriately to simplify calculations.</p> <p>Excellent: In addition to the above, the candidate will evaluate his/her final number and provide explanation as to how changes to assumptions would affect the estimation.</p>
--------------------------------------	--

VALUATION

Case 6: Scotch Bar

Valuation

DMCC

Round 1

<p>Prompt</p>	<p>You are sitting in one of Chicago's oldest scotch bars with a fellow intern. It is a Friday night after a busy week at your summer internship. The weather is mild—a perfect summer evening. While enjoying one of the bar's finest stogies and sipping an 18-year old McCallen single malt, your friend asks you how much you think the bar is worth. Using a back-of-the-envelope calculation, how would you go about determining the value of this bar?</p>
<p>Guidance</p>	<p><i>This is an estimation case. Because the candidate does not know much about the bar he/she should ask for details. To estimate cash flow, a “Revenue – Cost” framework is useful. The value of the bar is the present value of future cash flows.</i></p> <p>The following information should be given if requested:</p> <ul style="list-style-type: none"> ▪ <u>Product Mix and Pricing</u>: The bar sells two things, liquor and cigars. The average cost of a cigar is \$9 and the average cost of a drink is \$12. (Note: these average cost numbers will prove irrelevant, but in cases one is sometimes given irrelevant info.) ▪ <u>Capacity</u>: The maximum capacity is 100 people. ▪ <u>Location</u>: The bar is located on one of Chicago's busier streets for foot traffic. ▪ <u>Hours</u>: The bar is open Tuesday thru Sunday from 5 pm until 2 am. ▪ <u>Staff</u>: A bartender, a waiter, and a waitress. All three were there the entire evening. ▪ <u>Tax Rate</u>: 40% ▪ <u>Discount Rate</u>: 13% ▪ <u>Annual Growth Rate of Cash Flows</u>: 3% <p><i>The candidate will most likely not ask for all of this information upfront. Allow the candidate to make some assumptions about revenues. One way to project revenues is to estimate the number of customers per day or per week and multiply that by the average expenditure of each customer. Watch for realistic assumptions and logical thought progression.</i></p>

Case 6: Scotch Bar

Valuation

DMCC

Round 1

Prompt – part II

Ask the candidate what might drive variation in these numbers. The answer is days of the week (Fridays and Saturdays are typically busier than other days) and seasonality (people tend to be out more during summer than winter).

Guidance

While the candidate talks you through his/her approach, but before the candidate does a substantial amount of calculation, hand the candidate **Exhibit 1**. If the candidate does the math correctly, the revenue should add up to \$568,000.

Calculations	Fridays and Saturdays	Rest of Week
Spring and Summer (Equals 25 weeks. 50 weeks in a year)	\$4,800*2 Days = \$9,600 for Friday & Sat.	*16.667 is 1/6. Use fractions whenever possible
	\$9,600*25 Weeks = \$240,000 Total	\$4,800*1/6* 4 days (Monday is closed) = \$3,200
	\$240,000 Total	\$3,200 * 25weeks = \$80,000 Total
Fall and Winter	3/4* \$240,000 = \$180,000	
	\$180,000 Total	0.85*\$80,000 = \$68,000 Total
Total	\$420,000	\$148,000

The candidate should then proceed to costs. There are two components: fixed costs and variable costs. Have the candidate brainstorm possible fixed costs and variable costs. Under fixed costs the candidate might consider rent, general maintenance, management, insurance, liquor license, and possibly employees. The only real variable cost is the cost of goods sold. Allow the candidate to brainstorm costs before revealing the following data:

Variable costs are 20% of total revenues, and fixed costs are \$120,000.

Case 6: Scotch Bar

Valuation

DMCC

Round 1

<p>Guidance Cont'd...</p>	<p><i>After the candidate has subtracted costs from revenues, he/she should have an income of \$334,400. Do not forget that we need the after-tax cash flow number (approximately $\\$334,000 * (1-40\%) = \\$200,400$ (or $\\$200,000$ for ease of calculation in next prompt). You now have the annual cash flows generated by the bar.</i></p> <p><i>At this point a great candidate will drive the process forward and recognize that they need to figure out a stream of cash flows going forward. The interviewer may have to nudge less-savvy candidates toward the next step (discounted cash flow analysis).</i></p>
<p>Prompt</p>	<p>How does one perform a valuation of the business?</p>
<p>Analysis</p>	<p>To perform a valuation in this case, the candidate must estimate the cash flows from the business and discount them back using a perpetuity formula. The discount rate typically used for bars of this genre is 13%. When the candidate inquires about growth rates, say the bar's cash flow is growing at 3%-- the rate of inflation. Thus, whatever numerator the candidate arrives at should be divided by $.13 - .03 = .10$, an easy calculation. Use the $CF / (r - g)$ formula for a perpetuity.</p> <p>In this case, the answer is around $\\$200,000 / .10$, or \$2 million.</p>
<p>Performance Evaluation</p>	<p>Expected:</p> <ul style="list-style-type: none"> - Accurate arithmetic <p>Good:</p> <ul style="list-style-type: none"> - Drive the process forward, accurate arithmetic. <p>Excellent:</p> <ul style="list-style-type: none"> - A great candidate will drive the process forward and recognize that they need to figure out a stream of cash flows going forward. Accurate valuation given assumptions.

Case 6: Scotch Bar

Exhibit 1: Daily sales

	Fridays and Saturdays	Rest of Week
Spring and Summer	\$4,800	16 2/3% of Fri a (Spring and Sun
Fall and Winter	3/4 of Spring and (Fridays and Satu	85% of Spring an (Rest of week

Case 7: Chemical Brothers Int.

Valuation

DMCC

Unknown Round

<p>Prompt</p>	<p>Your client Chemical Brothers International (CHEMBRO), is a major chemical producer, has retained your firm's services to evaluate the feasibility of acquiring another major player in the industry, Plastics of America (POA). Both companies are bulk commodity chemical producers. Your task is to analyze the future prospects of POA's major product line, a chemical used in the production of plastics. Should Chembro acquire POA?</p>
<p>Guidance</p>	<p><i>There are two issues in this case that should be addressed separately in the suggested order:</i></p> <ol style="list-style-type: none"> 1. <i>What issues need to be addressed in evaluating an M&A proposal? Qualitative</i> 2. <i>What is the valuation? Quantitative</i>
<p>Prompt – Part II</p>	<p>What strategic issues need to be addressed in evaluating an M&A proposal?</p>
<p>Guidance</p>	<p><i>The idea here is to get a sense of the candidates' business judgment and whether or not he/she is able to apply correct frameworks to diagnose the issue at hand.</i></p> <p><i>A strong candidate will recognize that this case deals with internal factors (synergies and economies of scale) as well as some external factors (opportunity costs and industry attractiveness). The candidate should include some of the following elements in his framework:</i></p> <ul style="list-style-type: none"> ▪ <i>Market Attractiveness / Industry Potential</i> ▪ <i>Operational Analysis (Synergies/Economies of Scale/ Network Externalities)</i> ▪ <i>Organizational and cultural compatibility</i> ▪ <i>Capability to enact acquisition: Financial, legal, and perceptual barriers</i>

Case 7: Chemical Brothers Int.

Valuation

DMCC

Unknown Round

Analysis

The candidates framework should cover the following buckets. Allow the candidate to ask for information about the major categories before giving the information. If the candidate is missing one of the buckets, prompt them with a question to get them on track.

Market Analysis

- End-users come primarily from the automotive industry
- Market size has been slowly declining over the last five years
- Within the last couple of years, prices have declined rapidly

Competition / Industry Analysis

- There are 10 major producers; the largest one with a 35% share; number two has 25%, and POA is third with 20%; the remaining share is divided amongst others
- The two largest competitors earn a small return; POA is slightly above break-even; the rest are operating at break-even or at a loss
- Relative capacity utilization in the industry is 60 to 70 % and has been so for the last 3 years. POA is also currently working at 75% of capacity
- The two largest competitors are highly diversified with this particular product line representing no more than 20% of their revenues
- Highly regulated industry with expensive pollution control equipment
- High barriers to entry because of the low profits and high investments required

Product value proposition / brand portfolio

- The price has been driven by self-destructive cuts from the leaders to gain temporary share points
- We do not foresee the development of any significant byproducts.
- Other possible uses: None.
- Complementary Assets: 50% of POA's sales are to the automobile industry

Case 7: Chemical Brothers Int.

Valuation

DMCC

Unknown Round

<p>Analysis</p>	<p>Finance and Operations</p> <ul style="list-style-type: none"> ▪ Cost is based on size/efficiency/age of plant, etc. Within the industry, POA is in an above average position. ▪ There are several operational improvements that could be implemented, and management has not been aggressive in its pursuit of quality and cost controls. ▪ Great economies of scale exist in marketing and transportation. (Not quantifiable) ▪ Operational synergies could represent an additional \$30 million in profits
<p>Prompt – Part III</p>	<p>After discussing the above-mentioned qualitative aspects in some detail, provide the candidate with Exhibit 1 when the conversation shifts to the topic of valuation.</p> <p>Ask candidate to compute the present value of acquisition.</p>
<p>Guidance</p>	<p><i>You may allow the candidate to use 10% rate of return and not 9% (12% Return on Capital – 3% Growth Rate) if requested. However ask him the effect on NPV of a higher vs. lower discount rate, to gauge his understanding of the concept. Answer: Higher discount rate means lower valuation.</i></p>
<p>Analysis</p>	<p>NPV analysis: Based on the information from Exhibit A, the net present value of the target company is = $\\$90M / (10\%) = \\900 million (assume perpetuity), which is less than the purchase price tag of \$950 million.</p> <p>Industry Attractiveness: not particularly attractive, unless the larger competitor can use economies of scale and dominant position for economic gain.</p>

Case 7: Chemical Brothers Int.

Valuation

DMCC

Unknown Round

Performance Evaluation

Expected: Candidate identifies that the purchase price is higher than the NPV. Recommendation wrap-up should clearly include a “go / no go” decision followed by quantitative (valuation) and qualitative (industry and compatibility analysis) facts..

Good: A strong candidate will recognize that this case deals with internal factors (synergies and economies of scale) as well as some external factors (opportunity costs and industry attractiveness).

Excellent: An excellent candidate will include some of the following additional insights.

A more comprehensive NPV would include the new cash flow from synergies, as well as the previously calculated NPV. Therefore the $\$900 \text{ million} + [\text{Synergies } 30\text{M}/(12\%-3\%) = 333\text{M}] = \$1,233\text{M}$ value of target > 950 price tag.

In addition to the cash flows expected from synergies, the potential economies of scale and tax advantages from funding the acquisition with debt could be seen as other sources of revenue.

These considerations further improve the deal.

- Competitive and regulatory responses to block the merger are reasonable to assume due to concerns over industry concentration.
- Benchmarking the value of the POA acquisition to other similar M&A in the industry.
- Consider what multiple of operating profits other acquisitions been valued at?

Case 7: Chemical Brothers Int.

Exhibit 1

Purchase Price	\$950 M
Annual operating income before tax	\$90 M
Cash	<i>\$30 M</i>
No. of employees	<i>2000</i>
Return of capital	<i>12%</i>
Market risk premium	<i>7%</i>
Growth rate	<i>3%</i>
Tax rate	<i>40%</i>

Case 8: Internet Portal Valuation

Valuation

Katzenbach

Round 2

<p>Prompt</p>	<p>You have been hired by the internal strategy group at Yahoo. You are asked to analyze the recent acquisition of YouTube, an online video community, by Google for \$1.6 billion. Is this move a competitive threat for Yahoo?</p>
<p>Guidance</p>	<p><i>This is a valuation case and involves assessing the potential threat of competition's merger to the business. The case is primarily qualitative in nature and tests the candidate's conceptual understanding of M&A activity and overall business knowledge/judgment. The case offers the candidate several opportunities to be creative in problem-solving. A quality candidate will imbue the discussion with structure, creative solutions, and demonstrate knowledge of current business landscape.</i></p> <p><i>Core Competencies and Overall Situation Analysis - The candidate should think about the acquisition against the backdrop of the core competencies that each firm brings to the table. There are no absolute right/wrong answers; one approach is outlined below.</i></p>
<p>Analysis</p>	<p>Yahoo has positioned itself as a destination site. It wants consumers to go to Yahoo! and explore all of its wonderful services, spending time and money there. Time means that advertisers' ads are more likely to be clicked. Money means that Yahoo! is making ecommerce transactions, or selling subscriptions to premium online services. It tries to promote a sense of community among its users.</p> <p>Google has spent its early years as a search engine. To 'google' has become synonymous with search. To take advantage of this brand-name recognition, Google pioneered advances in adbased software that allowed businesses to better target consumers segments based on the particulars of the search. Google has the "eyeballs" of the consumers, but it doesn't have the consumers' wallet. It wants to monetize all this traffic.</p> <p>The acquisition of YouTube by Google is a competitive threat. You Tube is a move toward creating a community. The company spent \$1.6 billion because it believes it will be able to monetize this traffic somehow.</p>

Case 8: Internet Portal Valuation

Valuation

Katzenbach

Round 2

<p>Prompt – part II</p>	<p>Competitive Response – Inform the candidate that Yahoo wishes to counter this threat and assume that feasibility and cost are not a concern at this point. Ask the candidate to develop a competitive response and give candidate creative license. There are no absolute right/wrong answers; some ideas are outlined below.</p>
<p>Guidance</p>	<p><i>The candidate should ask for a moment to collect his/her thoughts, and ideate creative solutions</i></p>
<p>Analysis</p>	<p>Suggested Answers:</p> <ul style="list-style-type: none"> ▪ Create an offering to counter YouTube for the Yahoo community ▪ Buy Google ▪ Find a way to share real-time videos among friends from mobile devices or wristwatches. This would involve a cross-selling strategy with a partner ▪ Create backdrops (or allow open source coders to create them) from historical events or sporting arenas or famous movies, and enable people to be able to re-enact scenes or create new ones (An example of this might be a rock stadium backdrop and you and your friends can jam on instruments and make a rock video)

Case 8: Internet Portal Valuation

Valuation

Katzenbach

Round 2

<p>Prompt – part III</p>	<p>Provide candidate the hypothetical situation in which Google decides to proceed with the YouTube acquisition and believes that it can charge \$150 per user annually and make 67% margins. Ask the candidate to determine if Google can break-even with its current user base?</p>
<p>Guidance</p>	<p><i>Information to be given if asked:</i></p> <ul style="list-style-type: none"> • User base: 40 million • Discount rates should be ignored • Assume no user base growth or attrition.
<p>Analysis</p>	<p>Acquisition Cost = \$1.6bn Therefore, Margin/user needed to recover acquisition cost = \$40 Actual Margin/user = \$100 per year Therefore, Google will break-even.</p>
<p>Performance Evaluation</p>	<p>Expected: . At a minimum, the candidate will offer structured and well developed answers throughout in addition to demonstrating a good understanding of the current business landscape. Good: A good candidate will differentiate themselves by offering creative solutions in addition to a baseline set of core case competencies, structured answers, and showing an understanding of the current landscape. Excellent: The excellent candidate will offer insightful, structured answers throughout and show comfort in both driving the case and being prompted. The candidate will offer creative solutions as well as a deep understanding of the M&A market and the implications for all parties in the deal.</p>

Case 9: Cinemas

Valuation

Bain

Round 2

Prompt

Our client is a global cinema chain with \$20B in revenues. Growth options in the current business are limited. The CEO has been given the opportunity to acquire a private Australian cinema chain, which has exhibited poor growth in recent years. The CEO has asked Bain to determine whether this could be an attractive opportunity. The other Bain work streams have calculated that the business will need to generate \$2.0B per year in revenues for the next 5 years for the deal to generate a profit. The opportunity to bid for the cinema chain closes in 2 hours and you need to recommend to the client whether they should proceed with the acquisition or not.

Guidance

Key questions the candidate should ask: What is the annual revenue for the cinema chain? What revenue improvement opportunities or risks exist?

Make the candidate build up to an annual revenue. Ask them to brainstorm revenue streams before giving them details:

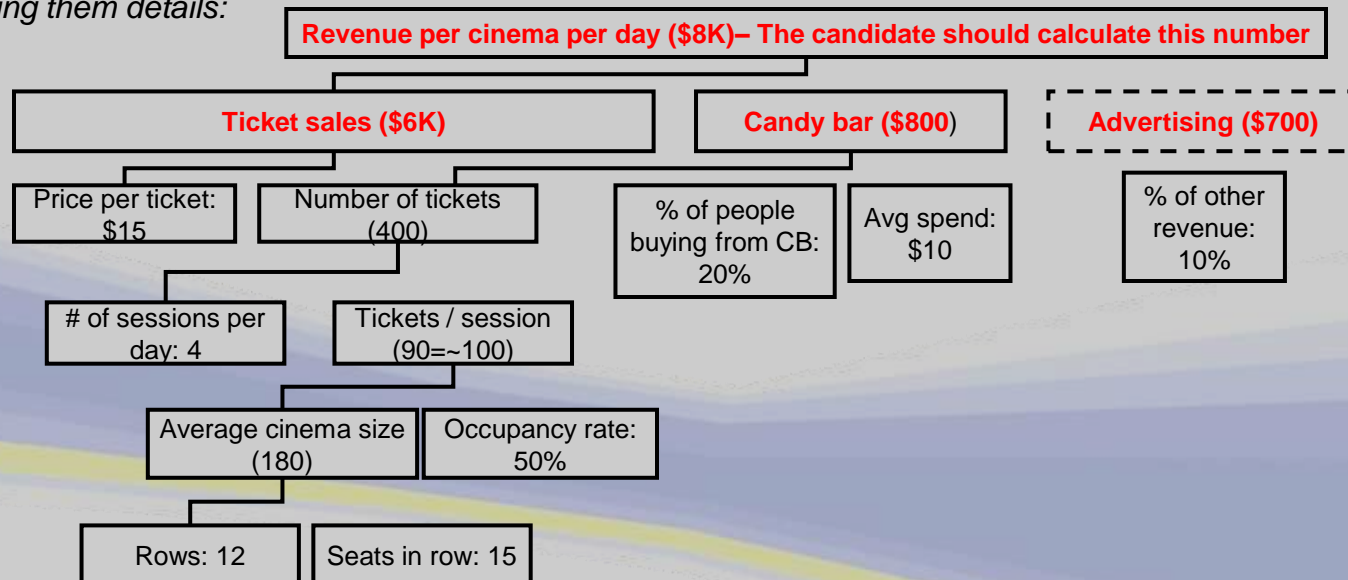

Case 9: Cinemas

Valuation

Bain

Round 2

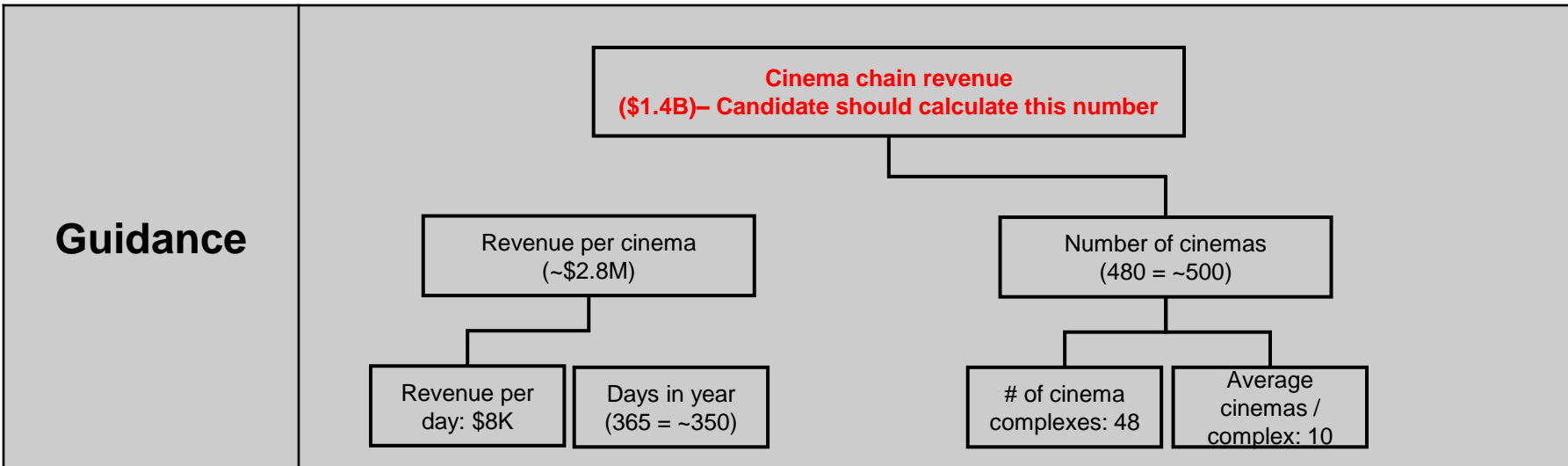

- Analysis**
- Candidate should now push on to test the market dynamics and future revenues.*
- Looking at revenue drivers
 - Possible drivers that could change are:
 - Occupancy
 - Sessions per day
 - % patrons who buy at Concession Booth (CB)
 - Average spend at CB
 - Other new revenue sources
 - Price per ticket
 - Market share
- } Future popularity of movie-going
 } Ability to extract additional discretionary spend
 } Competition, from both competitors as well as substitutes

Case 9: Cinemas

Valuation

Bain

Round 2

Analysis

- Candidate should comment that it would be difficult for the CEO to change external factors
 - E.g. size of the market would be quite stable, or declining
 - E.g. market share is difficult, but not impossible to change

- Candidate should comment that internal factors are easier to influence
 - E.g. increase revenue from 'up-selling' candy bar snacks
 - E.g. offering more expensive tickets (premium seating)
 - E.g. increasing the prices of advertising

- Candidate should then suggest rough magnitude of changes
 - E.g. if you could get 20% of customers to buy from the candy bar, it would be worth \$800 per cinema, or an extra 10%

Performance Evaluation

Expected: Candidate is able to recognize 90% of the inputs that would make up annual revenue. He/She is able to drive to the revenue answer without being prompted to move from one number to the next.

Good: Candidate does the above while also recognizing the levers that could either increase or decrease the annual revenue recognizing which levers would be easier to influence and which would be more difficult.

Excellent: Candidate starts to assess the magnitude of change, i.e. if we could increase the % of customers that buy from the candy bar it would be worth \$800 per cinema. This is showing a true understanding of the case and the client's goals.

PROFITABILITY

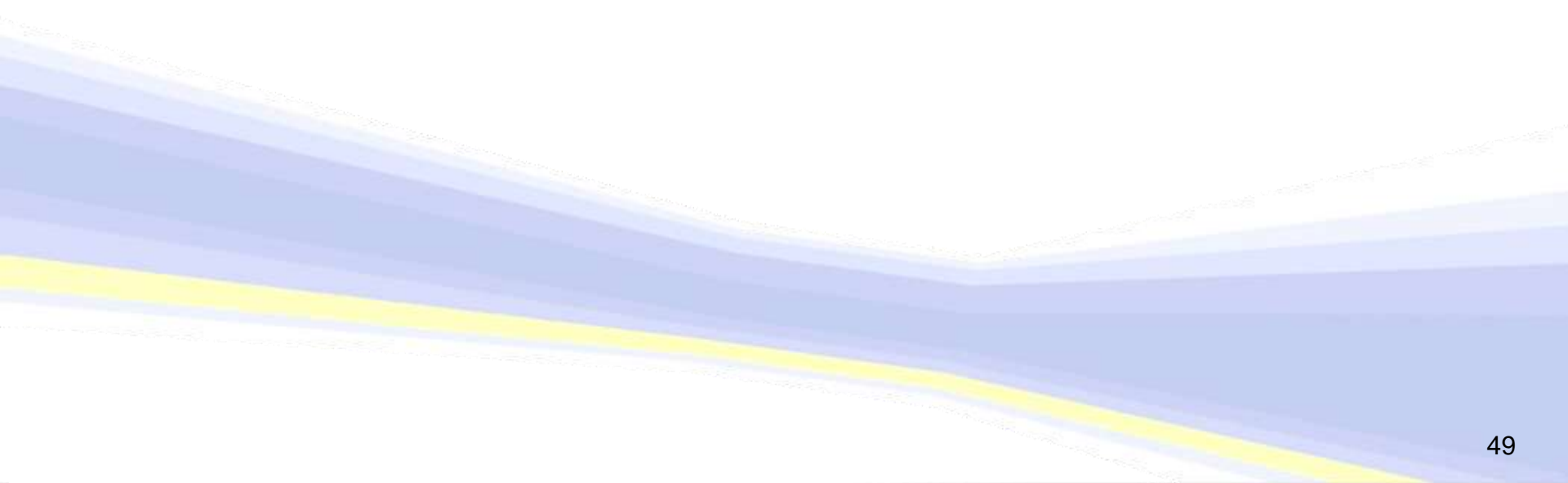

Case 10: Slick Hick Farm Equipment

Profitability

DMCC

Unknown Round

<p>Prompt</p>	<p>Your client is Slick Hick, a large agricultural equipment manufacturer. Its primary product line, farming tractors, is losing money.</p> <p>What questions would you ask of your client to help them solve their profitability problem?</p>
<p>Guidance</p>	<p>The candidate should outline a general profitability framework ($P*Q - (FC + VC*Q)$) and identify competitors as a necessary piece of understanding.</p> <p><u>Competitors</u> - Two direct competitors.</p> <p><u>Market share</u> Current: Client has 40% of the market, competitor #1 has 30% competitor #2 has 15%, with the remaining 15% belonging to many small manufacturers. Trends: Five years ago, your client had 60% of the market, competitor #1 had 15%, and competitor #2 had 10%. Your client has lost significant market share to its two main competitors over the last few years.</p> <p><u>Customers</u> - All three competitors sell to the same customers.</p> <p><u>Price</u> Client's product is priced higher than others. This has always been the case. Differences that allow for a premium price: Client has a strong reputation/image of quality in the market and the market has always been willing to pay a premium for that reputation because it implied a longer lasting more reliable product. This is critical for some farmers because they cannot afford to have a piece of equipment break down.</p> <p><u>Features</u> The products all have the same basic features. However, tractors are not commodity items and a few differences do exist.</p>

Case 10: Slick Hick Farm Equipment

Profitability

DMCC

Unknown Round

<p>Analysis</p>	<p>$(PQ - (FC + VC * Q))$</p> <p><i>Revenue insight: Quantity decrease driven by market share loss has driven revenues down</i></p> <p><i>Costs insight: VC increases are driving unprofitability. The specific VC driving this is finished part prices. The client assumed customers would pay more for better products, but they are not.</i></p>
<p>Guidance</p>	<p><u><i>Candidate should explore reasoning for profitability decline by asking the following questions:</i></u></p> <p><i>Change in sales revenues: Revenues are down.</i></p> <p><i>Change in sales quantities: Quantity is down.</i></p> <p><i>Change in price: Prices are up.</i></p> <p><i>Change in costs: Costs are up</i></p> <p><i>Change in fixed costs: Unchanged.</i></p> <p><i>Change in variable costs: Variable costs have increased tremendously. The client does not know why material prices have gone up so staggeringly.</i></p> <p><u><i>Candidate should deep dive on variable cost breakdown by identifying potential buckets</i></u></p> <p><i>Type of operation (manufacturing or assembly-only): Primarily assembly.</i></p> <p><i>Change in finished part prices: Finished part prices have gone up.</i></p> <p><i>Change in raw material prices for suppliers: Not to client's knowledge.</i></p> <p><i>Change in supplier labor costs: No change. Also, no change in suppliers.</i></p> <p><u><i>Candidate should then probe on why finished part prices have gone up.</i></u></p> <p><i>Reason for suppliers charging higher prices for the same products: They're not--the prices have increased as a result of product improvement efforts. Client has tightened tolerances and improved the durability of component parts.</i></p> <p><i>Reason for product improvements: Client strives to sell the world's best tractors.</i></p> <p><i>Customer willingness to pay for product improvements: Client assumed yes.</i></p>

Case 10: Slick Hick Farm Equipment

Profitability

DMCC

Unknown Round

<p>Analysis</p>	<p><i>Prices have been raised to cover the costs of improvements, but customers do not place a high value on the improvements, so the price increase has resulted in a drop in sales. The client needs to incorporate a cost/benefit analysis procedure into its product improvement process. The client should also evaluate their marketing plans to ensure their customers are aware of product improvements and understand their value. Before scaling back their product improvement process, the client needs to evaluate competitor's R&D and product improvement positions.</i></p>
<p>Performance Evaluation</p>	<p>Expected:</p> <ul style="list-style-type: none"> - Profitability framework - Market share probing <p>Good:</p> <ul style="list-style-type: none"> - Identify need to understand profitability decline in terms of changes in revenue and cost levers - Key in on variable cost increases and identify key buckets that go into building a tractor <p>Excellent:</p> <ul style="list-style-type: none"> - Asking probing questions on why part prices have increased and if these increases have been passed to the customer - Making recommendations for cost repositioning and assessing market risks

Case 11: Nabisco's Market Share

Profitability

DMCC

Round 1

<p>Prompt</p>	<p>The salted food division at Nabisco has been steadily losing market share over the past two years, from a high of 20% to the current level of 18%. Profits as a percentage of sales, however, have been growing. What could be causing this?</p>
<p>Guidance</p>	<p><i>Here is some information that will help the candidate analyze the situation:</i></p> <p>Market Size or Company Sales: Show Exhibits 1&2</p> <p>Main Competitors: Largest competitors are two multinational consumer products companies that feature complete lines of snack foods. Together, the two companies have about 50% of the market share.</p> <p>Differentiation from competitors: Nabisco's sales reps are regarded as the best in the industry.</p> <p>Change in client's product line: None</p> <p>Change in client's costs over the period, as % of selling price: Show Exhibit 3.</p> <p><i>Exhibit 3 may generate questions about promotion, sales force reductions, sales channels, reasons for changing the marketing budget, etc. when asked, provide the following information about sales channels, sales force, promotions, etc.</i></p> <p>Reason for sales cut: Sales force cut to reduce costs, but number of outlets unchanged</p> <p>Cause of change in the marketing budget: The changes come from reduced trade promotions</p> <p>Sales channels: Products primarily sold in large grocery store chains and convenience stores</p> <p>Sales force/customer interaction: Sales force visits each customer at least once per quarter.</p> <p>Timing of promotions: Promotions usually occur at the end of each quarter.</p> <p>Impact of promotions: Promotions required for end of aisle displays and advertising space.</p>

Case 11: Nabisco's Market Share

Profitability

DMCC

Round 1

<p>Analysis</p>	<p>Sample framework:</p> <p>External Factors: A decrease in market share may suggest Competitor dynamics: Existing players have increased market share New players have entered the market Market dynamics: Market is growing Client is unable to capture the growth. Why?</p> <p>Internal Factors Market share loss may suggest that the company is not spending enough on promotions Growing profits may suggest that the company is reducing cost</p> <p>Potential Conclusion The data show a large decrease in sales force and marketing expenditure. Most of the marketing reduction was in trade promotions. Product is sold through grocery chains and convenience stores, which are traditionally driven by periodic trade promotions. The reduction in trade promotions brought about a loss of shelf space, which led to a decrease in market share. Also, the product line did not change in a product category where new products and line extensions are routine. The market has been growing, indicating a missed opportunity for new products in the market. Lastly, profitability increased due to lower costs, but it may not be sustainable.</p>
<p>Performance Evaluation</p>	<p>Expected: The candidate will put together a framework and walk the interviewer through his thought process before asking relevant questions.</p> <p>Good: The candidate will recognize this as a case dealing with company revenue-cost structure (internal), as well as some external factors.</p> <p>Excellent: The candidate will synthesize the information provided and present a clear and concise summary to CEO John Keebler on how and why the sales channel/sales force/promotions have impacted Nabisco's market share.</p>

Case 11: Nabisco's Market Share

Profitability

DMCC

Round 1

Exhibit 1

Growth in Total Sales, Nabisco

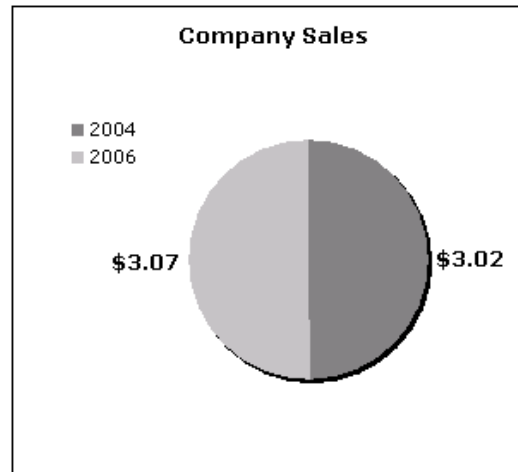
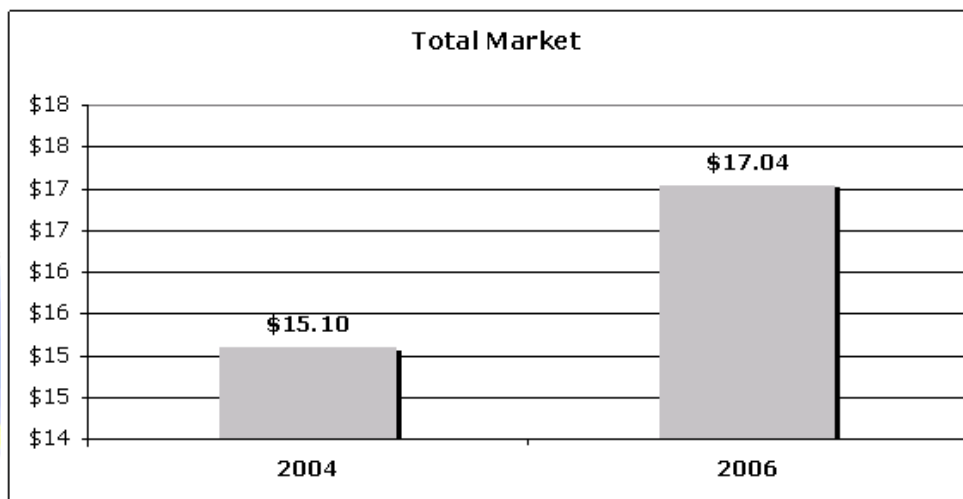

Exhibit 2

Growth in Total Market



Case 11: Nabisco's Market Share

Profitability

DMCC

Round 1

Exhibit 3

Company Cost Structure

<u>Cost</u>	<u>Current</u>	<u>Two Years Ago</u>
Raw Ingredients	28%	26%
Conversion costs	24%	24%
Distribution	8%	9%
Marketing	16%	18%
Sales force	7%	9%
Pre-tax profit	17%	14%

Case 12: Sgt. Slaughter

Profitability

Accenture

Round 1

<p>Prompt</p>	<p>Sergeant Slaughter's Construction Company is a leading provider of construction and infrastructure materials. It has two divisions: Oil & Gas and Government. The government division's main customer is the US Military. Your client is offering construction services to help the US military to build bases. Construction includes dining facilities, dorms, and infrastructure projects for troops around the world. Each division has its own procurement department. The procurement for the government division spends \$6 billion on the items they purchase. They resell those items for a profit to the Government. The Vice President of procurement for the government division called your consulting firm to advise them on how to spend less money on the purchased items and operate more efficiently.</p>
<p>Guidance</p>	<p><i>The candidate should take some time (~1 min) to draw a framework and walk through the framework for the interviewer. Sgt. Slaughter's Construction Company needs to make its procurement more efficient and determine how to reduce procurement costs. Address the problem as an operations/value chain problem and try to identify the links and levers that could influence the efficiency. The candidate should generate themes within the company to potentially explore. Here are four killer ideas.</i></p> <ol style="list-style-type: none"> 1. <i>The contractual relationship with the suppliers and the government.</i> 2. <i>The efficiency of the workers</i> 3. <i>The synergies within the company – the collaboration with the Oil & Gas division</i> 4. <i>The efficiency of the information flow - technology</i>

Case 12: Sgt. Slaughter

Profitability

Accenture

Round 1

<p>Prompt – Part II</p>	<p>First we need to understand the nature of the business relationship between the suppliers and the Government. What information do we need to accomplish this?</p>
<p>Guidance</p>	<p><i>Possible questions and analysis:</i></p> <ul style="list-style-type: none"> ▪ <i>What kind of contracts do they have, long-term or short-term?</i> ▪ <i>What are the advantages/disadvantages of being in long-term contracts or short-term?</i> ▪ <i>How constant is the demand? Does the government always spend \$6 billion on this contract or is it expected to grow or decline?</i> ▪ <i>How many suppliers? Is there volatility in the demand or supply?</i> ▪ <i>What is Sergeant's competitive advantage? Is there competition for the contract?</i> <p><i>Give the candidate the relevant information below.</i></p> <p><i>Contracts between suppliers and the Government division are short-term in nature. The company has only one supplier. The supplier offers the best cost/quality ratio and Sgt. Slaughter would like to keep it, if possible. The client is not the only customer for the supplier but is one of the largest. The company is the main supplier for the Government. They are the best at what they do. They do not need to worry about the competition as long as they maintain the present prices and quality.</i></p> <p><i>Note: The interviewee should ask about the volatility of demand and infer that a long-term contract with the supplier will be less beneficial if Government spending on military bases is volatile (for example, if the Iraq war ends tomorrow, demand will drop). Also, a single supplier could be grounds for diversification to improve negotiating power.</i></p>

Case 12: Sgt. Slaughter

Profitability

Accenture

Round 1

Analysis

See what ideas the candidate can generate. Remember that Sergeant Slaughter cannot negotiate a better price from Uncle Sam. The proposed solutions should not dwell on competitive issues.

Possible proposals:

- Try to identify multiple suppliers or negotiate a better deal with the current one using this possibility as bargaining power.
- Create long-term contracts that should offer better pricing, but negotiate a “call clause” if the Government drops the demand.
- Try to identify synergies with the Oil & Gas division

Case 12: Sgt. Slaughter

Profitability

Accenture

Round 1

<p>Prompt – Part III</p>	<p>What organizational questions should we ask about the people?</p>
<p>Guidance</p>	<p>Possible questions and analysis:</p> <ul style="list-style-type: none"> • Are the people that deal with the suppliers experienced enough? • Are there incentives in place? What can be changed? • Is their staffing model efficient? Do they work enough? Are they efficient? What is their level of productivity? • Can/should we lay off workers? • Do they have enough training? <p>Here is some information to relay to the candidate. Consider it to be like a data dump—see how well the candidate can drink from the fire hose.</p> <p>The staff is not necessarily the most experienced in the field. They are not very good at negotiating with the supplier, due primarily to lack of experience. The VP of Procurement is actually a newly hired, former lawyer. The workers do not focus on negotiating with the supplier, as they spend most of the work on troubleshooting the contracts and enforcing them (have the items delivered on time, ordering the supplies ahead of time, forecasting demand etc). The productivity of the workers is an issue. They have a target of 88% productivity time for the workers (88% of the time they are paid, they should work productively for the company) but the workers are productive only 80% of their time billed. There are no training and learning processes in place for the workforce. Also, the bonus structure is fixed. They receive a 10% undifferentiated bonus at the end of the year if the company makes a profit.</p>

Case 12: Sgt. Slaughter

Profitability

Accenture

Round 1

<p>Analysis</p>	<p>See what ideas the candidate can generate.</p> <p>Possible proposals:</p> <ol style="list-style-type: none"> 1. Try to hire more experienced workers 2. Offer training 3. Add incentives - bonuses connected to the money they save from the supplier 4. Reduce the workforce; put a productivity check in place to raise it to the 88% mark. 5. Have the Procurement manager get an MBA!
<p>Prompt – Part IV</p>	<p>Let's address bargaining power and find synergies with the Oil & Gas division. What can we ask Sergeant Slaughter?</p>
<p>Guidance</p>	<p>Possible questions and analysis:</p> <ul style="list-style-type: none"> • Do they have the same supplier? • How much is the Oil & Gas ordering comparing with the \$6 billion for Government? • Are the divisions interacting? • Do they collaborate to have a stronger bargaining power? • Do they share information and data about their supplier's contracts and demand forecast? • Can they combine the procurement departments for the two divisions and have one larger for the entire company? <p><i>Here is some background information for the candidate:</i></p> <p><i>The Government division does not communicate efficiently with the Oil & Gas division. They use the same supplier but they have issues integrating data therefore one of the recommendations should address technology and information sharing issues. They do not have a common database with prices across the globe and former experiences. The Oil & Gas division accounts for \$2 billion in orders from suppliers.</i></p>

Case 12: Sgt. Slaughter

Profitability

Accenture

Round 1

<p>Analysis</p>	<p>Possible proposals:</p> <ol style="list-style-type: none"> 1. Coordinate better with the Oil & Gas division and try to integrate orders to obtain stronger bargaining power over the supplier 2. Try to institute a common system to communicate future orders/demand and try to negotiate them together 3. Build a database accessible to both divisions with prices negotiated with multiple suppliers in time to have a common negotiating basis 4. Organize meetings with the procurement teams of both divisions to share best practices and negotiating tips 5. Unite the two procurement departments into one larger, company-wide solution
<p>Prompt – Part V</p>	<p>The VP calls you for an update. Please inform him of your findings.</p>
<p>Guidance</p>	<p><i>The student should wrap up the case in 3-4 sentences (30-60 sec) such as:</i></p> <ol style="list-style-type: none"> 1. State a position 2. Give evidence based on case 3. Other considerations and/or creative aspects <p><i>To reduce cost, the VP could combine the two divisions from a technology, procurement, and workforce perspective. Additionally, the productivity of the workers needs to be increased through training and new hires. Last, the company should try to negotiate long-term contracts with the government and aim to obtain lower prices from suppliers.</i></p>

Case 12: Sgt. Slaughter

Profitability

Accenture

Round 1

Performance Evaluation

Expected:

- Interviewee takes subtle cues from interviewer to move on to next topic
- Ability to generate at least several solutions

Good:

- Creativity in generating solutions (and many of them)
- Listing solutions in a final “Recommendations” slide used to conclude case

Excellent:

- Carries the discussion well. This is not a case where the interviewee leads. Instead, the interviewee should make sure the case is conversational - just the right amount of back and forth and no awkward pauses.

Case 13: Bank Commissions

Profitability

Accenture

Round 2

<p>Prompt</p>	<p>Your client is a regional commercial bank and your task is to make a recommendation to improve the profitability of the retail segment of their business operations. Specifically you are required to evaluate the merits of a proposal made by the CFO - a commission-based incentive program targeted at the bank's tellers with the objective of increasing product sales. How much commission should the bank pay its tellers per unit of product sold?</p>
<p>Guidance</p>	<p><i>This information should only be given if asked (or if the candidate is struggling).</i></p> <p><i>Product Mix:</i> The bank has four products it wants to sell in this program - CDs, Checking accounts, Mutual funds, and IRAs. <i>[The Interviewee should ask for more information about the products, without which we cannot ascertain the profitability of each product in the mix.]</i></p> <p><i>Revenue Streams:</i> If the interviewee asks for the bank's sources of revenue for the products, first ask the interviewee to list what he/she thinks are the specific sources of revenue for the bank's four products. The answers are not important to the case. However, it will 1) illustrate the interviewee's creativity and 2) check the candidate's poise. <i>Possible answers : Interest generated, commission earned, perhaps an overnight float option, synergies or economies of scale from cross selling.</i></p> <p><i>Profit Margins:</i> The interviewee should ask for the profit margin on each of these products in order to estimate a commission structure. Information to be given if asked: <i>The profitability is as follows:</i></p> <ul style="list-style-type: none"> ▪ <i>CD's: 2% with an average \$4,000 initial deposit</i> ▪ <i>Checking: 4% with an average \$2,000 initial deposit</i> ▪ <i>Mutual Funds: 1% with an average \$8,000 initial deposit</i> ▪ <i>IRA's: 2% with an average \$4,000 initial deposit.</i>

Case 13: Bank Commissions

Profitability

Accenture

Round 2

<p>Guidance</p>	<p>Incentive Program Options – <i>The Interviewee should arrive at a profit margin of \$80 per product and constrain his incentive program within this range. Explore at least four different incentive options.</i></p> <p><i>Answer: A fixed fee per product, a percentage of the profits, a fixed fee for a certain number of products sold that would decline after a threshold, or a variable commission depending based on products and spreads.</i></p>
<p>Analysis</p>	<p>Criteria for selection of incentive program - Ask the Interviewee what information he would need to determine the best incentive program for the bank .</p> <p>Answer:</p> <p>Profitability - The ease of sale, whether all tellers are equally effective sellers, profit per teller or per customer, estimated commission as a percentage of current salary, cost of incentive program</p> <p>Human Capital – The program that best motivates employees to sell products and increases retention rate.</p> <p>Tell the interviewee that his/her choices can be narrowed down to one. In this case, the assumption is that all the tellers are equally effective and that all the products can be sold with roughly the same effort. So what would you base the commission on then? Why?</p> <p>Answer: Fixed fee option as it is a straightforward incentive and has a large upside for employees. Also administration costs are relatively less.</p> <p>[Note: It is possible that the interviewee comes up with an even better answer than this. If that is the case, acknowledge the answer and tell them the client would like to proceed with the fixed fee option]</p>

Case 13: Bank Commissions

Profitability

Accenture

Round 2

<p>Analysis</p>	<p>Cost of incentive program - Steer the Interviewee toward discussing the cost structure of the fixed fee incentive program. The Interviewee should ask about the present salaries of the tellers and the expected sales/teller.</p> <p>Information to be given if asked:</p> <ul style="list-style-type: none"> ▪ Average Salary per year per teller: \$25,000 ▪ Expected sales/teller: five products per week. <p>Thus: Annual sales/teller = 250 products (5 products per week * 50 weeks per year)</p> <ul style="list-style-type: none"> ▪ Commission Fee = \$10 ▪ New profit margin = (\$80-\$10) = \$70 <p>Ask the interviewee to wrap up. "I have a meeting with the CFO in 5 minutes. Tell me your final recommendation."</p>
<p>Performance Evaluation</p>	<p>Expected:</p> <ul style="list-style-type: none"> ▪ You understood the interviewee's framework / plan to solve the case ▪ Referred to framework often to ask questions ▪ Asked for help when lost. ▪ Calm and collected <p>Good:</p> <ul style="list-style-type: none"> ▪ Made a final recommendation and included data. ▪ Integrated data well and reached insights by seeing the big picture ▪ Drove the case <p>Excellent:</p> <ul style="list-style-type: none"> ▪ An excellent candidate will do all the above and will mention risks or practical implications of recommendation: ▪ Tracking field in their accounting system to associate correct teller ID with sales made ▪ Changes in payroll systems ▪ Sales training program for tellers ▪ Effectiveness study to measure impact on employee retention/satisfaction

Case 14: Electronics Co.

Profitability

Bain

Round 1

Prompt

Your client is Electronics Co., an audio/video sales and repair retailer with 500 stores located primarily on the West coast. In 2001, revenues were \$520M - \$120M from repairs of equipment (e.g. TVs, VCRs etc.) and \$400M from sale of equipment (primarily TVs).

Electronics Co. has been in business for 30 years and is known for its fast, professional service. However, profits have been flat for the past 4 years and competitors have not seen similar problems.

The client wants to know why its competitors are outperforming Electronics Co. Also, they want to know how Electronics Co. can improve its profitability.

Guidance

The candidate should restate the prompt in an organic way, not word-for-word.

If asked for details on Electronics Co.'s growth vs. its competition, E Co.'s stock price increased only 2% from 1998 to 2001, while competitors have achieved 15% growth. If the candidate asks about the growth of the market, encourage them to think through possibilities using the stock price information (i.e., competitors are grabbing a larger share of a growing market, competitors have found a way to grow margins substantially). Thinking through the market conditions thoughtfully will show that the interviewee is a strong candidate.

If asked about specific financial benchmarks, you can share that the client wants to quantify the potential profit improvement but that the client is looking for the interviewee to determine that number.

Case 14: Electronics Co.

Profitability

Bain

Round 1

<p>Analysis</p>	<p>As the candidate asks questions about labor, you may let them know that E Co has 2 repair people per store, vs. its competitors that have 0.5 – 1 repair person per store and that each store has 10 jobs per week, which average about 2.5 hours to complete. Each store is open M-F 8am – 6pm and repair people are paid \$60K annually.</p>
<p>Performance Evaluation</p>	<p><u>Expected:</u> Candidates should know to look at revenues and costs. Since competitors are mentioned in the prompt, candidates should also ask for market related information.</p> <p><u>Good:</u> Insights from each of the exhibits: 1: E Co’s sales are flat despite a market that is growing at nearly 4% annually, and repairs are down despite overall market growth. 2: Labor is a big cost bucket. Good candidates should seek more information. 3: E Co’s profitability is very low, indicating that costs are out-of-line.</p> <p><u>Excellent/Deeper Insights (Second Years):</u> These candidates will show an ability to offer practical solutions. For example, in Exhibit 2, great candidates will ask how E Co.’s profitability compares to its competitors and seek WHY. They will calculate utilization of the repair people to determine if cuts can be made and will calculate the profit impact of savings from labor (25 hours of work per week; 100 hours of labor available per week – only 0.5 repair person needed per store; savings of \$90K per store * 500 store = \$45M in savings). If a candidate attempts these calculations, provide Exhibit 4.</p>

Case 14: Electronics Co.

Exhibit 1 – A/V sales & repair markets

Profitability

Bain

Round 1

Market size

Annual Growth
95-01

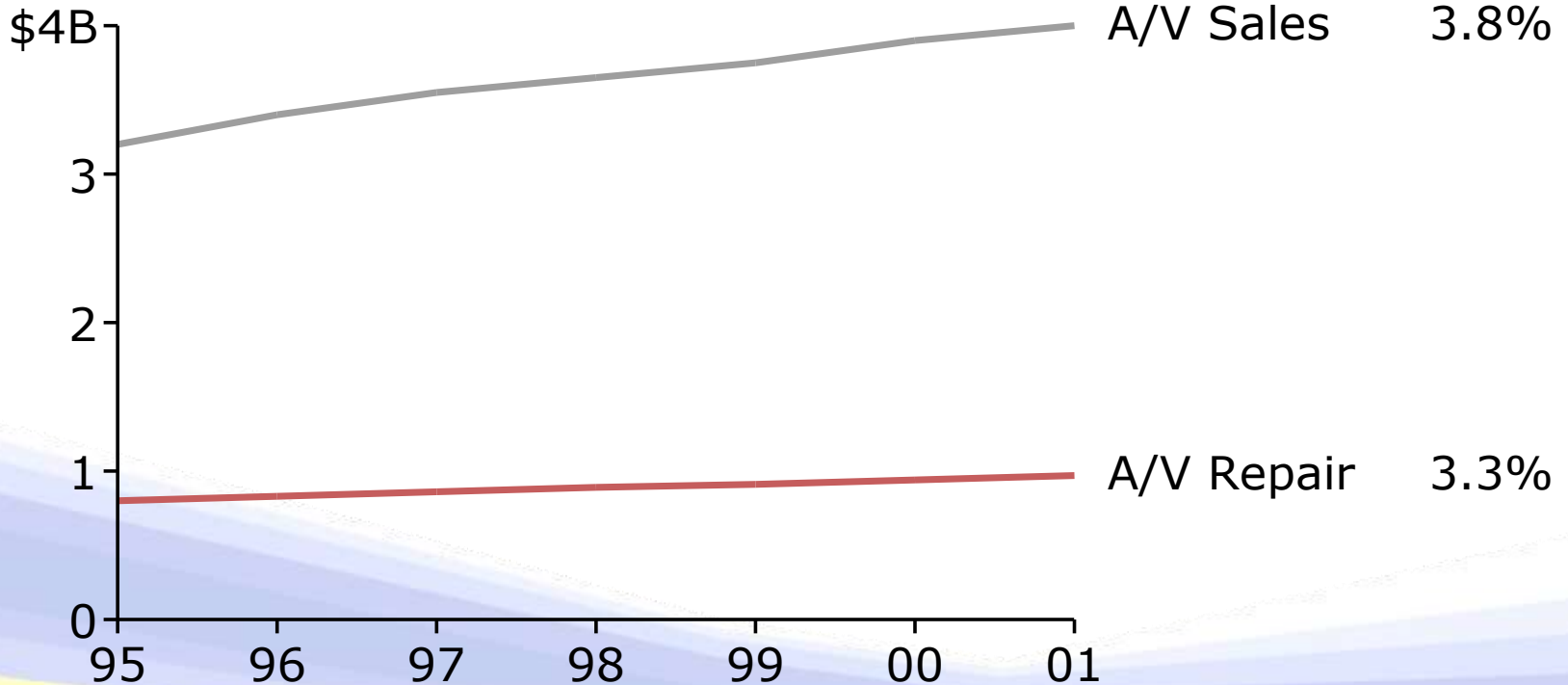

Sales	10.3%	10.2%	10.1%	10.2%	10.4%	10.3%	10.4%
Repair	13.0%	12.8%	13.2%	13.3%	12.9%	13.1%	12.2%

Case 14: Electronics Co.

Exhibit 2 – Competitor profitability for A/V repair

Profitability

Bain

Round 1

Profit margin (A/V repair)

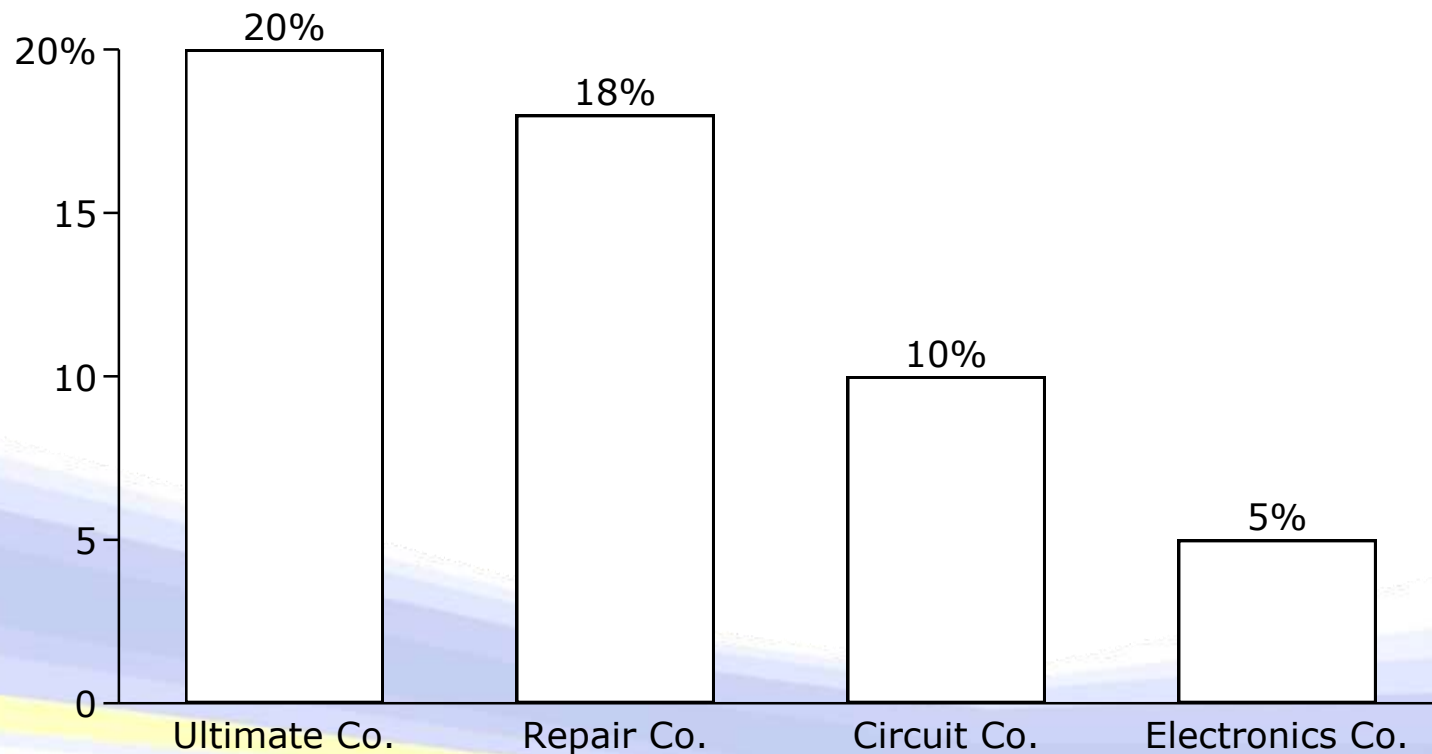

Total A/V Revenues

\$24M

\$80M

\$50M

\$120M

Case 14: Electronics Co.

Exhibit 3 – Electronics Co. cost structure

Profitability

Bain

Round 1

Percent of total revenue

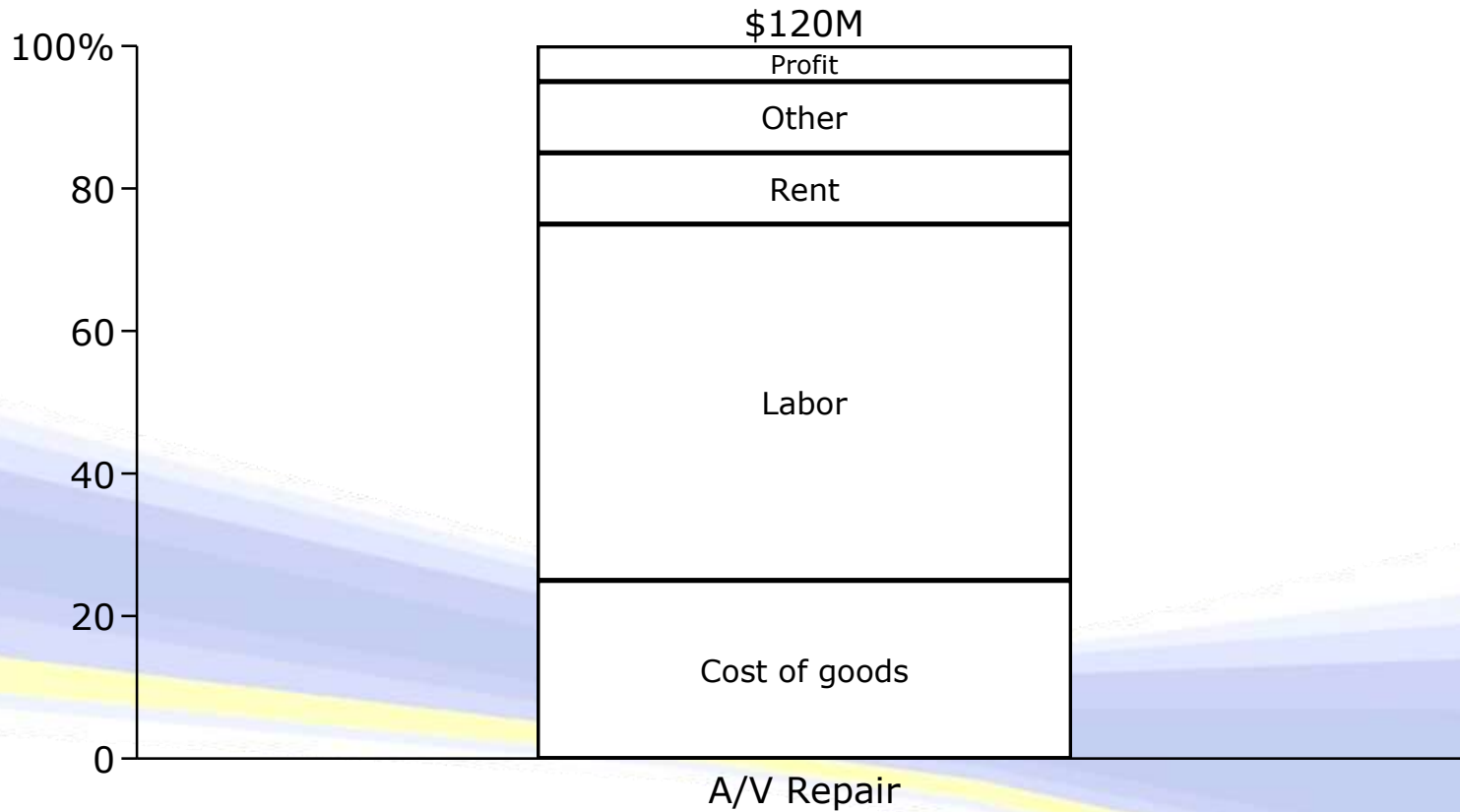

Case 14: Electronics Co.

Exhibit 4 – Savings opportunity

Profitability

Bain

Round 1

Change in costs

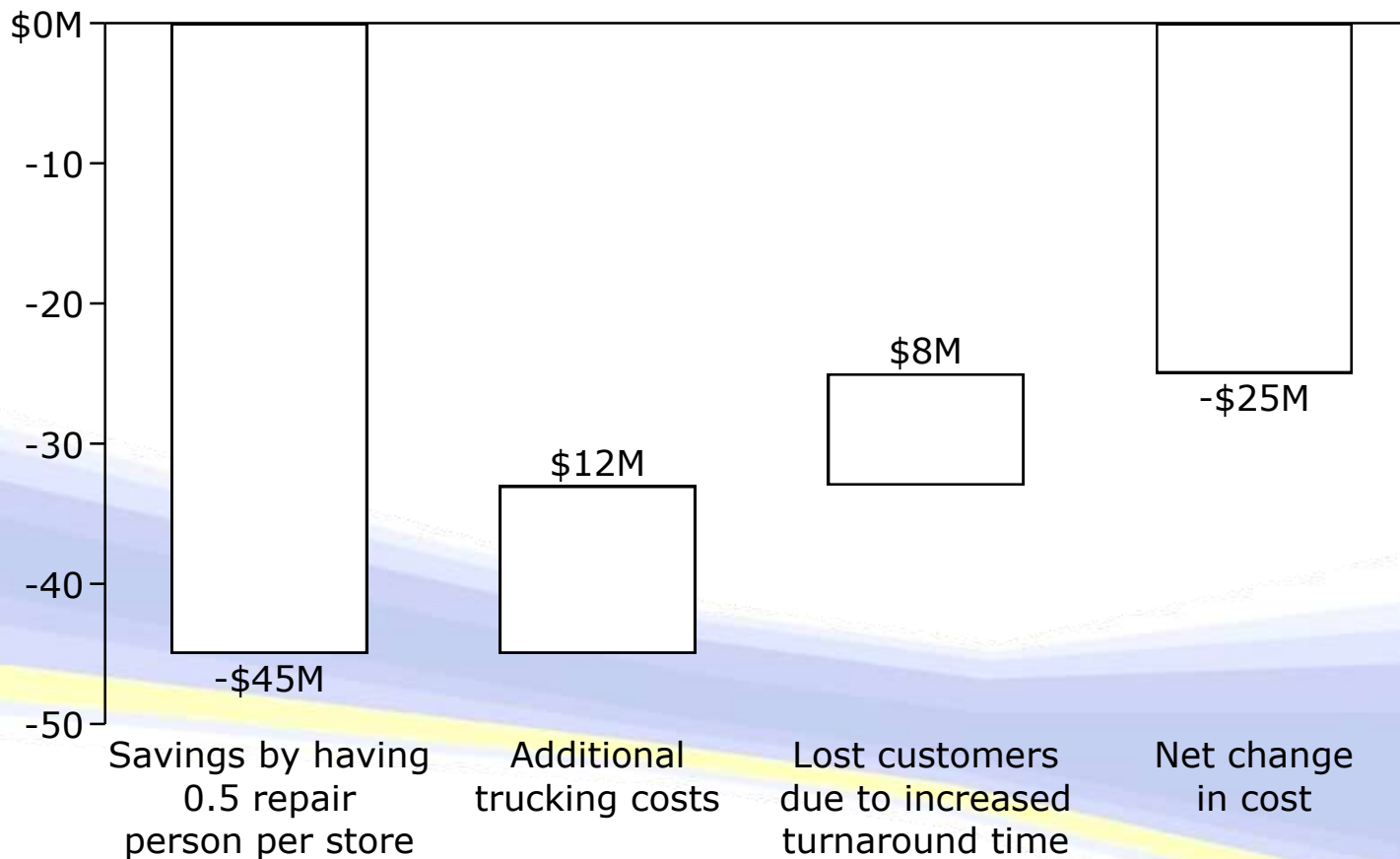

Case 15: Convenience Store

Profitability

BCG

Round 1

<p>Prompt</p>	<p>Our client is a major convenience store chain with 5,000 stores in the US and \$25B in annual revenues. About one year ago their CEO hired our firm to help increase profits. Since then, we have worked with the client to aggressively control costs through negotiating larger discounts from suppliers, restructuring the client’s labor force, and cutting other operating expenses by 10%. As a result of our work, our partners believe there is little room for cost reductions going forward. How else can we increase profits for our client?</p>
<p>Guidance</p>	<p>1) Background data (TO BE GIVEN ONLY IF ASKED):</p> <ul style="list-style-type: none"> • <i>There are 4 major companies (including the client) in the industry that control 95% of the market. Each has a roughly similar share of the market.</i> • <i>Client is not interested in expanding/changing product line.</i> • <i>Client does not want to expand internationally due to logistical concerns.</i> • <i>We studied possible M&A activities, but there are no desirable targets.</i> • <i>Client charges same price per item in each of its stores. (i.e. no difference between prices of one item in Manhattan versus Durham)</i> • <i>Consumers consider Motrin and Tylenol to be very different brands, with each having very loyal customers. It would take a substantial change in price of one brand to convince customers to switch to the other. Buyers of both brands would consider the store brand product, however they feel that it is a slightly inferior product and would need to be incentivized to do so.</i> • <i>Advil and Motrin suppliers charge the same price to every convenience store chain</i> • <i>All other costs (overhead, etc.) should be considered the same across the 4 major chains</i> <p>2) Case delivery: <i>Initially try to get candidate to brainstorm about how they might be able to increase profits. Present candidate with Exhibit 1 if they inquire about pricing, products sold, or sales volumes. Depending on whether candidate wants to focus on Food&Bev or Pain Relievers first, present them with Exhibits 2 or 3 respectively.</i></p>

Case 15: Convenience Store

Profitability

BCG

Round 1

Analysis

Exhibit 1: Candidate should immediately focus on Pain Relievers and Food & Beverage segments. Pain Relievers have lowest margin and are most inelastic, which suggests opportunity to increase prices. Food&Bev is our best seller in terms of Sales and Scan Margin, so look for ways to sell more or gain share. Cleaning Product sales are \$4B. Price elasticities are meant to be illustrative and are not needed for any calculations. (Note: Scan Margin is essentially the same thing as profit margin, however it also includes funding from producers. It is a term frequently used by retailers).

Exhibit 2: Candidate should recognize that client has highest unit price and lowest volume/share relative to competitors in Food&Bev segment. This would imply that there is little room to increase prices in this category. He/she should recognize that this is not the solution and should go explore Pain Relievers .

Exhibit 3: Candidate is presented with Total Dollar Sales, Price and Cost data for each of the three brands of pain relievers. He or she can then calculate profit per unit, total unit sales, and total \$profit per brand

Exhibit 4: The key insight is that our client charges a lot less for Advil than the competition. We charge the same for Motrin and slightly more for Store Brand. A good candidate will inquire about market share data at this point, and should be presented with Exhibit 5

Exhibit 5: Candidate should determine that we have a very strong share in Advil (which accounts for over 50% of industry-wide pain reliever sales). This combined, with our significantly lower price and profitability in Advil, as well as slim likelihood that customers would switch brands or to our competitors, means that we should raise prices.

Case 15: Convenience Store

Profitability

BCG

Round 1

Performance Evaluation

Expected:

- Candidate recognizes that we need to focus on revenues going forward
- Identify that revenues are a function of price, quantity, and mix and ask for more data on each component
- Recognize that priority should be on investigating Food&Bev and Pain Relievers when viewing Exhibit 1 and ask for more information on each
- Determine that raising price of Advil is the solution to the case

Good:

- Quickly determine that Food&Bev and Pain Relievers drive profitability
- Candidate performs calculations quickly and accurately
- Recognize that Food&Bev is not the solution after viewing Exhibit 2
- Candidate will ask about competitor prices and market share data when viewing Exhibit 3

Excellent:

- Quickly recognize that client has highest unit price and lowest volume/share relative to competitors in Food&Bev segment. No need to perform market share calculations
- Inquire about shifting share to Store Brand to generate more profits (since it has highest profit per unit)

Deeper Insights (Second Years)

- Attempt to determine profit impact of increasing price of Advil
- Have insight that charging higher prices for same item in certain markets would be an opportunity to generate additional profits

Case 15 : Convenience Store

Exhibit 1 - Products Sold by Client

Profitability

BCG

Round 2

	Total Client Sales	Total Scan Margin	Price Elasticity
Pain Relievers	\$10 B		0.3
Cleaning Products		\$0.5 B	1.1
Food & Beverage	\$9 B	\$3 B	1.4
Other	\$2 B	\$0.4 B	1.8
Total	\$25 B	\$4.9 B	

Case 15: Convenience Store

Exhibit 2- Convenience Store Industry Food & Beverage Sales

Profitability

BCG

Round 2

	Average Price/Unit	Total Unit Volume	Total \$ Sales	Share
Client	\$1.50		\$9 B	
Competitor 1		10 B	\$14 B	
Competitor 2	\$1.35	12 B		
Competitor 3	\$1.45	8 B		
Total		36 B	\$50.8 B	

Case 15 : Convenience Store

Exhibit 2 ANSWER KEY – DO NOT SHOW CANDIDATE

Profitability

BCG

Round 2

	Average Price/Unit	Total Unit Volume	Total \$Sales Volume	Share of Total Market
Client	\$1.50	6 B	\$9 B	~18%
Competitor 1	\$1.40	10 B	\$14 B	~28%
Competitor 2	\$1.35	12 B	\$16.2 B	~32%
Competitor 3	\$1.45	8 B	\$11.6 B	~22%
Total		36 B	\$50.8 B	

Case 15: Convenience Store

Exhibit 3 - Client Pain Reliever Sales

Profitability

BCG

Round 2



	Total \$ Sales	Price/Unit	Cost/Unit
Advil	\$8 B	\$3.99	\$3.79
Motrin	\$1 B	\$4.99	\$4.49
Store Brand	\$1 B	\$1.99	\$1.29

Case 15: Convenience Store

Exhibit 3 **ANSWER KEY – DO NOT SHOW CANDIDATE**

Profitability

BCG

Round 2

Brand	Total \$ Sales	Price/Unit	Cost/Unit	Profit/Unit	Total Units	Total Profit
Advil	\$8 B	\$3.99	\$3.79	\$0.20	~2 B	\$0.4 B
Motrin	\$1 B	\$4.99	\$4.49	\$0.50	~200 M	\$0.1 B
Store Brand	\$1 B	\$1.99	\$1.29	\$0.70	~500 M	\$0.35 B

Case 15: Convenience Store

Exhibit 4- Convenience Store Pain Reliever Prices

Profitability

BCG

Round 2

Brand	Client Price	Average Competitor Price
Advil	\$3.99	\$4.69
Motrin	\$4.99	\$4.99
Store Brand	\$1.99	\$1.89

Case 15: Convenience Store

Exhibit 5 - Pain Reliever Market Share \$ by Brand

Profitability

BCG

Round 2

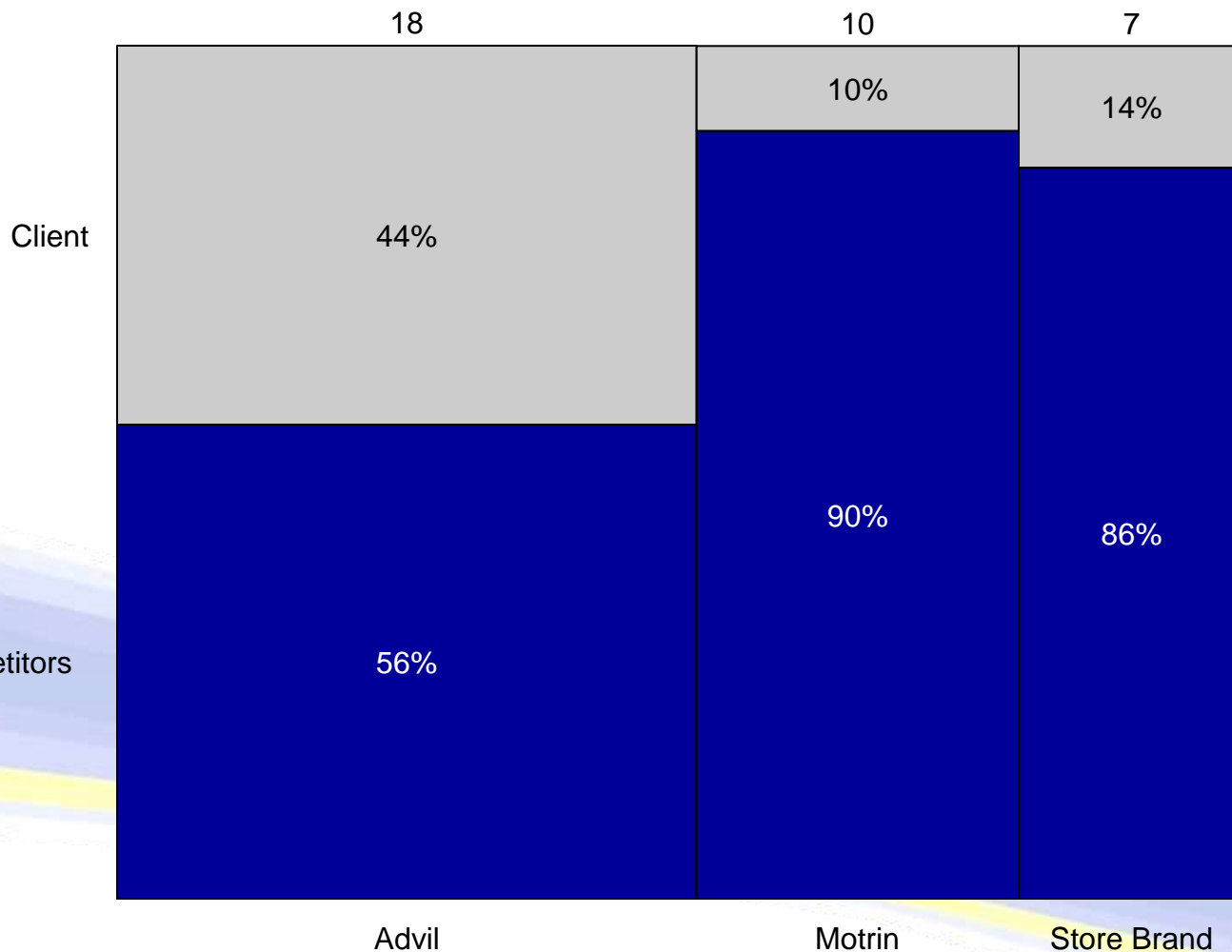

Case 16: Office Products Co.

Profitability

Bain

Round 1

Prompt

Your client is Office Products Co., which sells office supplies directly to businesses and consumers. It is direct retailer of office products through two channels: catalogue and internet. This market is growing, especially the internet.

Office Products Co. has experienced historic revenue growth rates of 10%/year; however, over the past two years, revenue growth has been flat and profit margins have been trending down.

Your job is to figure out what is causing the declining performance and determine what the management should do to turn things around.

Guidance

If asked, provide the following information:

- Client generates \$1B in annual revenue, and has been very successful (annual revenues have grown at 10% CAGR, operating margins at 12%)
- Client's catalogue sales have stalled, and its internet growth has lagged the market
- Catalogue clients have a higher profitability than internet clients due to higher \$/transaction (and higher retention rates)

A good candidate will list out the following buckets in their framework:

- Market dynamics: size, growth rates
- Company dynamics: revenue drivers (price, # of transactions, \$ per transaction), cost drivers, customer satisfaction
- Competitor dynamics: new market entrants, changes in prices, changes in channels, changes in customers, new substitutes

Case 16: Office Products Co.

Profitability

Bain

Round 1

<p>Analysis</p>	<p>Interviewer can provide the following information if asked:</p> <ul style="list-style-type: none"> • The market is segmented by channels; customers shop across channels and price points • Market information is listed in Exhibit 1. Sales information is listed in Exhibit 2. • There have been no new entrants, but competitors are gaining share.
<p>Performance Evaluation</p>	<p><u>Expected:</u> Sales are flat and margins down due to competitive entry into the internet channel. Client should focus on driving catalogue sales (which are profitable) and making internet sales more profitable.</p> <p><u>Good:</u> Office Products Co. should invest to grow the Internet channel, while protecting core Catalogue sales growth. Office Products Co. is losing share due to underinvestment in the Catalogue channel and aggressive moves by competitors in the Internet channel</p> <ul style="list-style-type: none"> - The Internet channel, while fast growing, is not currently profitable. Average purchase per customer is 1/5 of the catalogue channel. Investing in this channel is a long-term strategy given the small size and rapid growth rates. - The Catalogue channel, although slower growing, is profitable and represents the largest sales channel, at 90% of 2007 revenue. <p><u>Excellent/Deeper Insights (Second Years):</u> Great candidates will suggest practical solutions; for example, they may suggest that driving growth means driving more small/medium business users to internet in order to drive up \$/transaction and retention. They will also consider ways to reduce costs, or to gain economies of scale to drive profitability in the channel and consider ways to drive average purchase per customer to levels comparable with Catalogue sales.</p>

Case 16: Office Products Co.

Exhibit 1 – Market annual sales performance

Profitability

Bain

Round 1

Annual sales

CAGR '02-'07

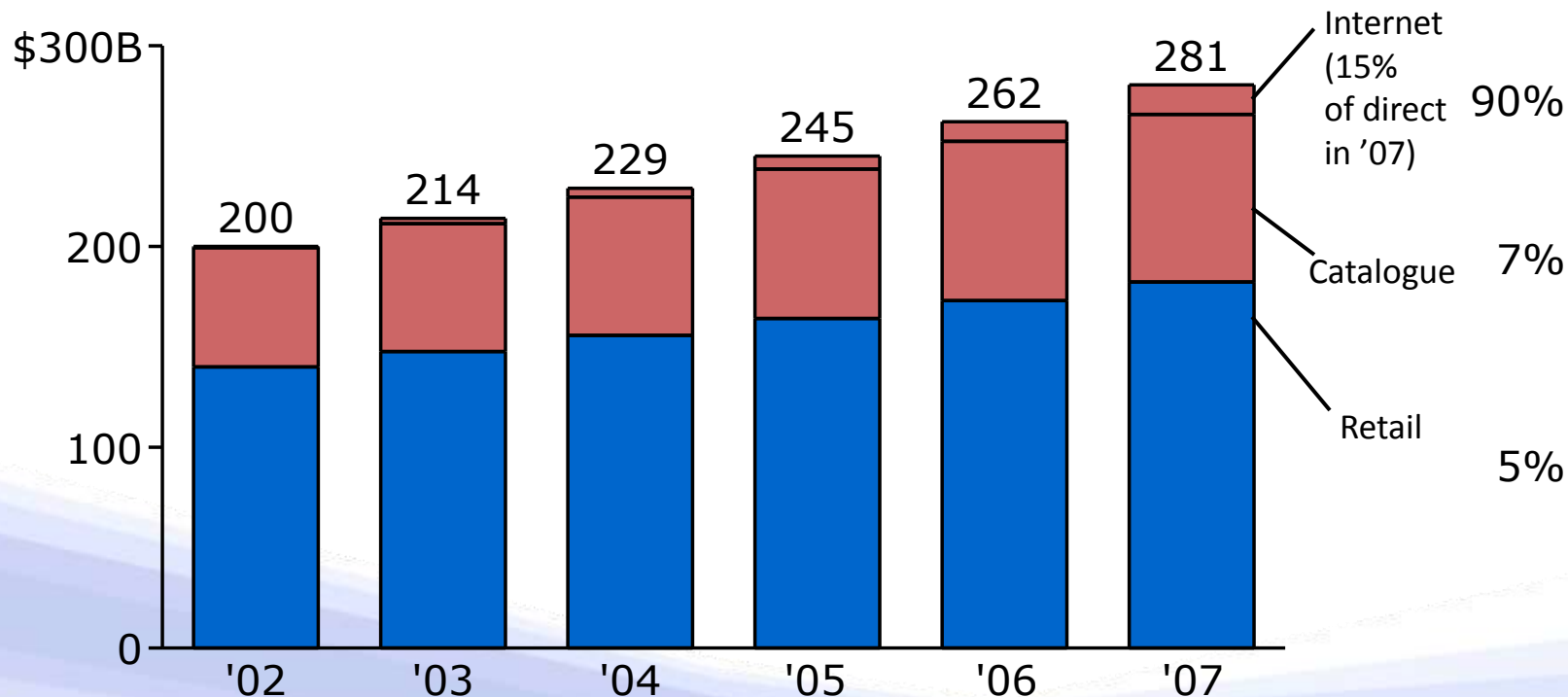

Market growth	7%	7%	7%	7%	7%	7%
Fraction direct channel	30%	31%	32%	33%	34%	35%

Case 16: Office Products Co.

Exhibit 2 – Office products Co. sales performance

Profitability

Bain

Round 1

Annual sales

CAGR '02-'07

7%

62%

5%

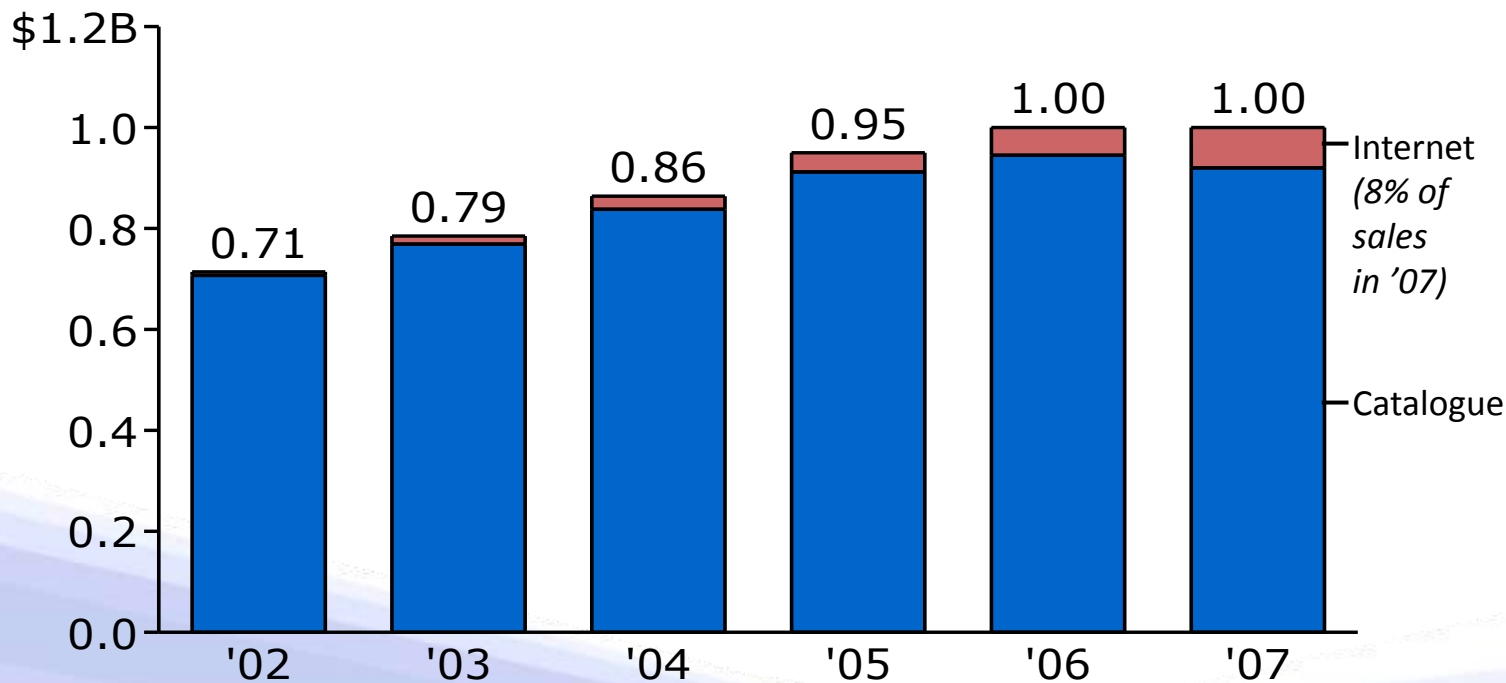

Sales growth	10%	10%	10%	10%	5%	0%
Prospecting catalogue circulation	3.0M	3.0M	3.0M	2.0M	1.5M	1.0M

Case 17: Euro Seafood

Profitability *Bain* *Unknown Round*

Prompt	<p>One of our private equity clients recently acquired a leading European seafood restaurant chain. The chain owns and operations 700 restaurants across Europe. Same store sales (SSS) declined last year. The private equity parent has aggressive expectations for improved business performance. How can the client improve SSS?</p>
Guidance	<p>When the candidate asks about SSS and the main driver of that, please hand them Exhibit 1. The main takeaway here should be that customer traffic is highly correlated with SSS growth.</p> <p>When the candidate asks for competitor information, please hand them Exhibit 2. The main takeaway here should be that there is limited opportunity to increase price or bill size.</p> <p>When the candidate asks about the current table configurations, please hand them Exhibit 3. The main takeaway here should be that there is opportunity to reconfigure the restaurants to accommodate more parties of one or two.</p>
Analysis	<p>The data shows that 4-seater tables are ~50% utilized during peak hours [Look at the chart. It is hard to read on purpose. About ¼ of the 4-seat tables are occupied by 3 people. About ¾'s of the 4-seat tables are occupied by 3 people. Thus, ¼(75% occupancy)+ ¾ (50% occupancy) = ~50% utilization]; there are on average 2 people sitting at a 4-seater (4-seat capacity*50% utilization).</p> <p>Lets assume we reconfigure each restaurant so that one 4-seater is separated into two 2-seaters, effectively adding 2 seats. When the candidate suggests this, prompt him/her by asking “What is the bottom line impact of adding 2 seats per restaurant?”</p> <p>Additional Seats: 2 Peak Hours: 2 (let the candidate make this assumption) Table turns per hour: 2 (let the candidate make this assumption) Additional meals per restaurant= 2 x 2 x 2 = 8 meals 8 meals/restaurant x 700 restaurants (give this number when requested) = 5,600 meals total 5,600 meals x \$50/average meal (give this number when requested) = \$280,000 revenue \$280,000 revenue x 30% margin (give this number when requested) = \$84,000 additional profit/day \$84,000/day x 360 days/year (let candidate make this assumption) = ~\$30 M additional profit/year</p>

Case 17: Euro Seafood

Profitability

Bain

Unknown Round

Analysis

Synthesis of the case facts:

Customer Traffic

- Traffic is the biggest contributor to SSS growth
- Client should focus on initiatives that add the most value with minimal investment
- Improved seat utilization could deliver an extra \$30M annually in profits

Number of items

- Average check size and margins are higher than competition

Price per menu item

- Client already priced at a premium over competitors

Performance Evaluation

Expected: The candidate will interpret handouts and offer insights while viewing them. The candidate will also recognize the opportunity to optimize the table configurations.

Good: The candidate will do all of the above while also probing about the table configurations without the interviewer's assistance. The candidate will begin to calculate the bottom-line impact without the interviewer's assistance.

Excellent: Candidate will do all of the above while also remembering to synthesize the entire case before closing out. Making sure to educate the client on our findings and not focusing on the opportunity to optimize the tables.

Case 17: Euro Seafood – Exhibit 1

Profitability

Bain

Unknown Round

Price per item

Number of items

Customer traffic

SSS change

SSS change

SSS change

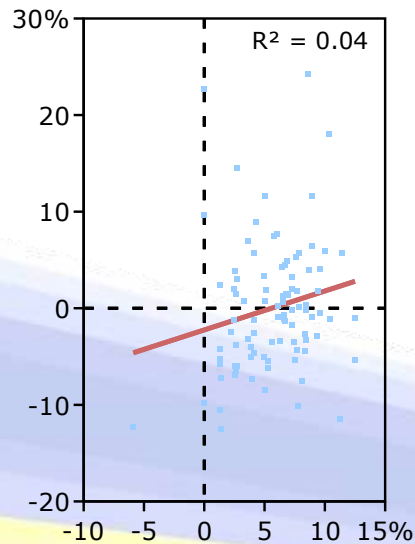

Unit Price change

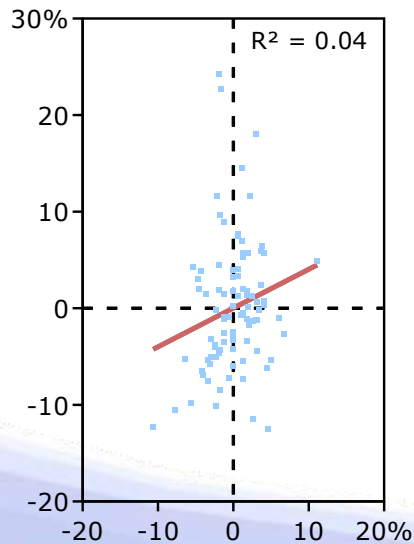

of items change

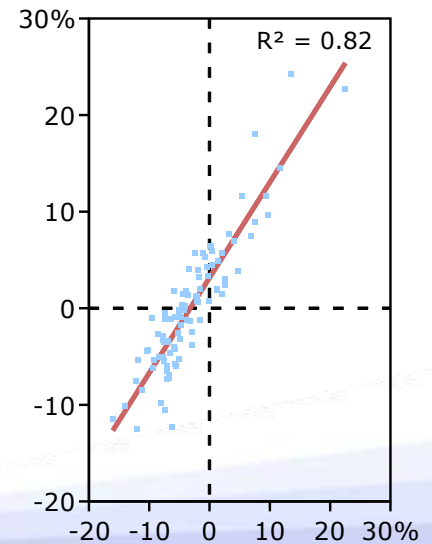

Monthly Traffic change

Case 17: Euro Seafood – Exhibit 2

Profitability

Bain

Unknown Round

Average price per menu item

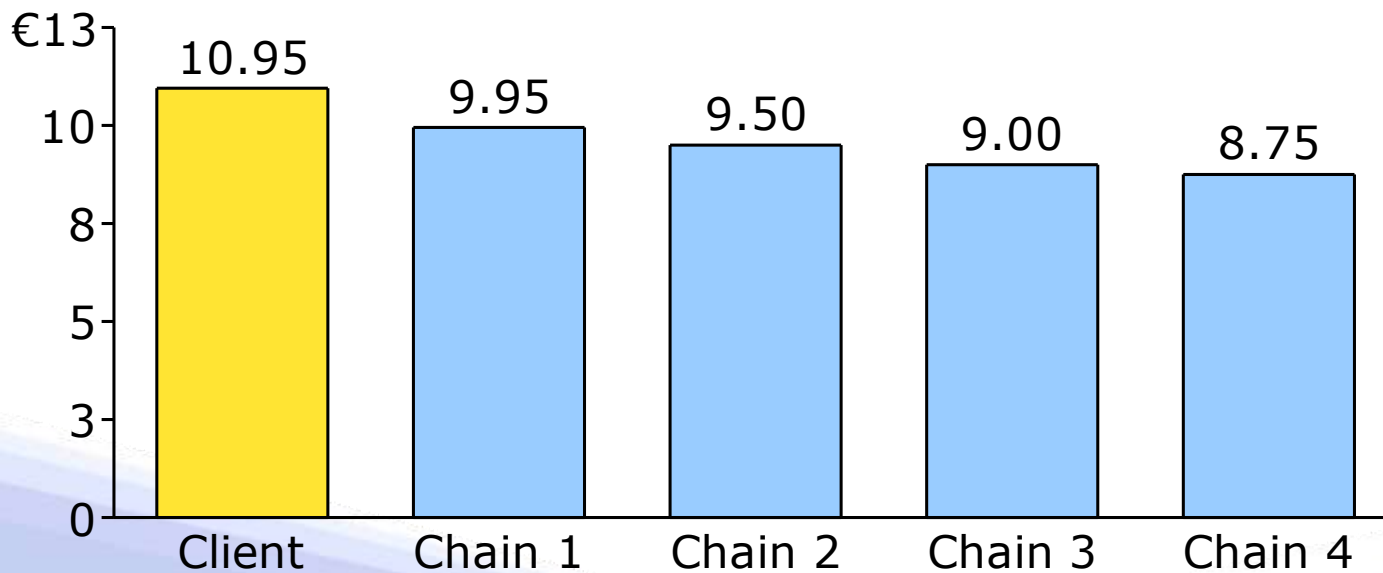

Items
per bill

4.4

4.6

4.1

4.7

3.9

Margin

30%

28%

27%

27%

16%

Case 17: Euro Seafood - Exhibit 3

Profitability

Bain

Unknown Round

Occupancy During Peak Hours

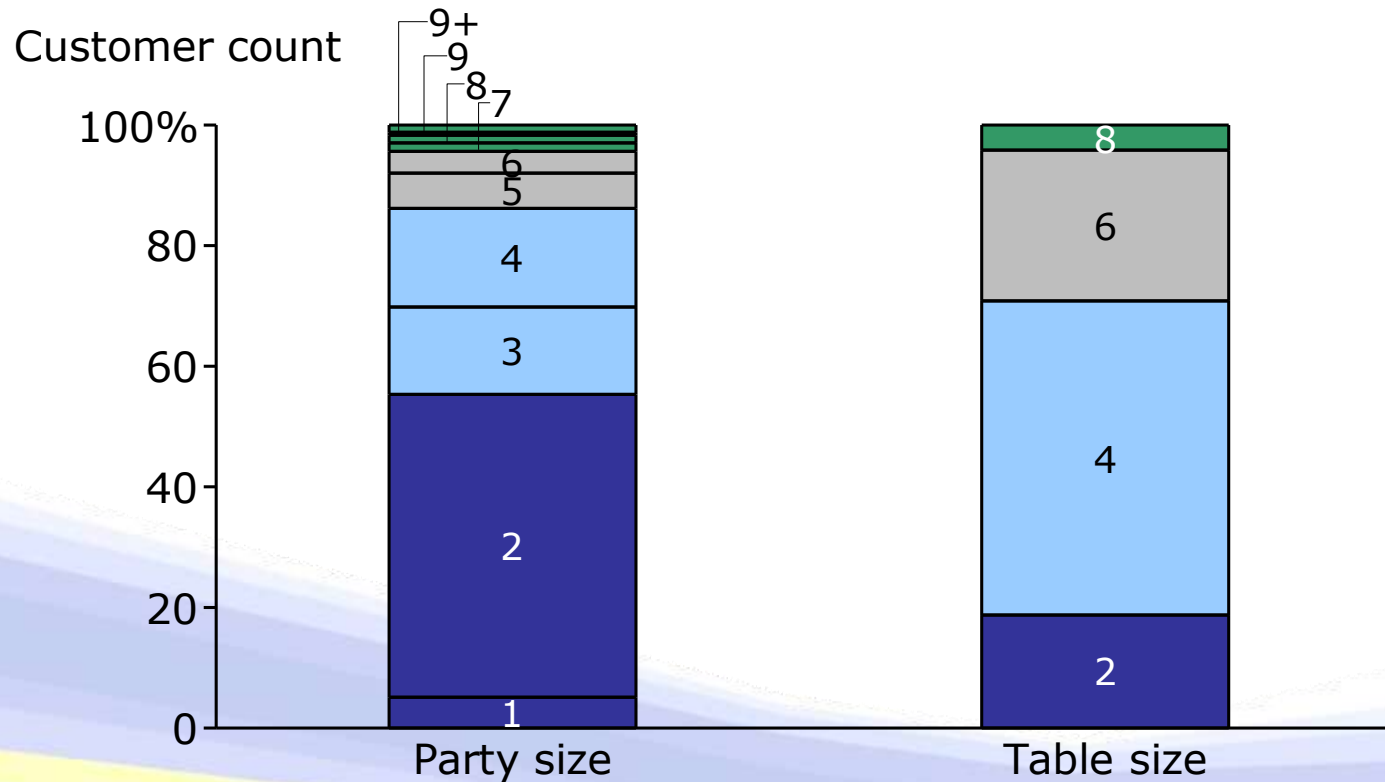

Case 17: Euro Seafood – Exhibit 3

Profitability

Bain

Unknown Round

Interviewer Copy. DO NOT GIVE CANDIDATE

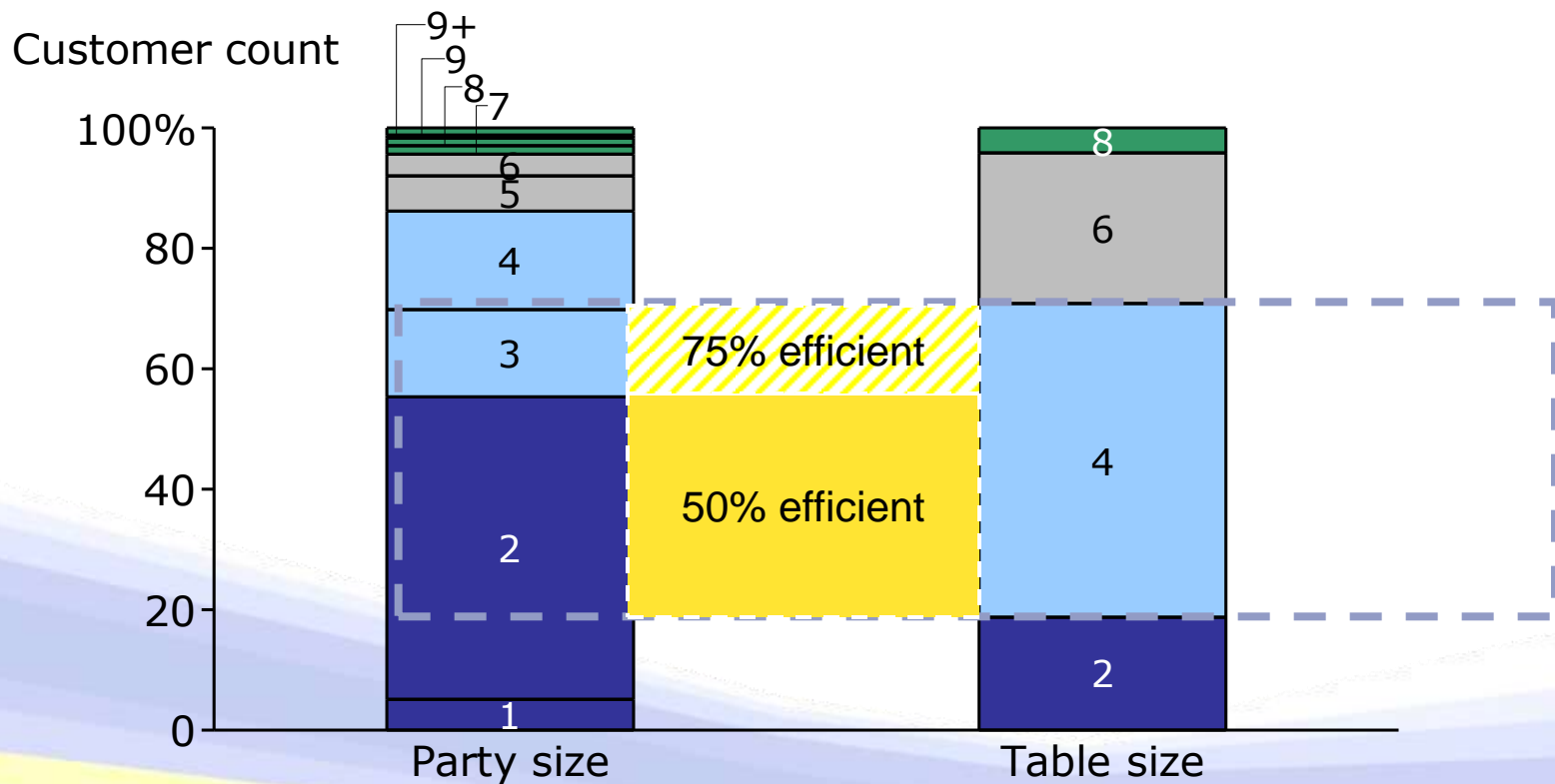

HUMAN CAPITAL

Note about nature of the Human Capital Cases: A Human Capital Case contains an approach much different from the usual “Strategy” case. However the candidate should not abandon the use of a framework. Here the focus isn’t so much on the bottom line as it is on the approach needed to manage the proposed changes in the organization. The case should be carried out in a conversational format with hints and clues to push the candidate alongside the case prompt.

Case 18: KGF's Learning Management

Human Capital

Deloitte

Round 1

Prompt

Your client is faced with dramatic changes in the industry. As your client adjusts their strategy and reacts to changes while anticipating future changes, they are concerned about their ability to keep their employees prepared for the challenges they will face. The client is also concerned about their traditional approach to learning and development and has questions about the return on investment of their current programs.

Your team was retained to help assess the effectiveness of the organizations learning center, develop a go forward learning strategy, and to select and implement an “appropriate” enterprise learning management system (LMS) solution that will allow the client’s learning center to successfully execute its learning strategy while simplifying its operational processes and allowing it to scale for future growth.

Please consider the following questions: What approach would you take to assessing the client’s current learning capabilities and developing the go forward strategy? What issues would you consider regarding the selection and implementation of the Learning Management System?

Note about nature of the Case: This is a Human Capital Case and thus contains an approach much different from the usual “Strategy” case. However the candidate should not abandon the use of a framework. Here the focus isn’t so much on the bottom line as it is on the approach needed to manage the proposed changes in the organization. The case should be carried out in a conversational format with hints and clues to push the candidate alongside the case prompt.

Guidance

Make sure that the candidate understands that you are looking for a qualitative analysis and not a quantitative analysis.

Look for a good framework that is logical and sound.

Case 18: KGF's Learning Management

Human Capital

Deloitte

Round 1

<p>Analysis</p>	<p>Review current learning activities - balance of instructor-led training, e-Learning, and other learning methods</p> <ul style="list-style-type: none"> ▪ Degree of learning assessment used (Reaction, Learning, Transfer, Results) ▪ Meet with leadership to determine requirements of new strategy ▪ Review individual learning plans ▪ Skill gap analysis ▪ Assess ability of existing programs to address needs, identify needs for additional learning programs ▪ Specific system selection and implementation components candidate may consider: <ul style="list-style-type: none"> ▪ Integration with HRIS system ▪ Data migration, system configuration, and interface development ▪ Self-service registration ▪ Degree of network vs. remote access ▪ Scalability
<p>Performance Evaluation</p>	<p>Expected: The candidate will touch on most of the major points listed in the analysis section, such as skill gap analysis, assess current program's ability to address needs, integration with HRIS system, scalability.</p> <p>Good: A good candidate will complete all of the above, as well as bring in a few creative concerns and solutions. For example, the candidate could express concern with employee compliance with the new system or talk about the benefits of the new system and the impact it will have on complexity within the organization.</p> <p>Excellent: An excellent candidate will address all of the major points listed in the analysis section while also bringing in creative insight.</p>

Case 19: Strugandt & Losen Merger

Human Capital: IT M&A

Deloitte

Round 1

<p>Prompt</p>	<p>The merger of two major technology companies forged a team of 140,000 employees with capabilities in 160 countries, doing business in 43 currencies and 15 languages. Contested by key members of the board until the final hours of the transaction, the merger had a media “fishbowl” Effect creating a myriad of rumors regarding layoffs heightening internal anxiety. The client needed to quickly formulate a strategy to deal with the rumors, stabilize the workforce, and set the strategic agenda for change.</p> <p>As a member of the project team can you please answer how you would structure an approach for the company’s executives to successfully address the potential issues and realize the full value of the acquisition?</p> <p><i>Note about nature of the Case: This is a Human Capital Case and thus contains an approach much different from the usual “Strategy” case. However the candidate should not abandon the use of a framework. Here the focus isn’t so much on the bottom line as it is on the approach needed to manage the proposed changes in the organization. The case should be carried out in a conversational format with hints and clues to push the candidate alongside the case prompt.</i></p>
<p>Guidance</p>	<p><i>Please make sure the candidate focuses on how this approach will be structured and delivered for the executive team, therefore they should stay high level with their approach.</i></p>

Case 19: Strugandt & Losen Merger

Human Capital: IT M&A

Deloitte

Round 1

Performance Evaluation

Expected:

Short Term:

- 1) Develop and deliver internal and external communications to all stakeholders (shareholders, Board, the Street, acquired employees, legacy employees)
- 2) Deliver honest, detailed communications as soon as possible to stop rumors (Key leadership from both companies should deliver these messages)
- 3) Review both organizations “as is”: culture, shared services at both organizations (i.e., HR, Finance, etc.), talent (what kind of skills/people need to be retained at both organizations)

Good: Good candidates will also mention:

Short Term:

- 1) Conduct a gap analysis between current state and desired future state

Long Term:

- 1) Solicit feedback: Talk to the employees to find out the rumors/ concerns/ fears/ etc.
- 2) Create a website with all the information about the merger (include a place to post questions/concerns/issues to make sure these are addressed so people don't feel like it's a black hole)

Excellent: Excellent candidates will also consider:

Long Term: Execution: Move new organization towards “future” state

- 1) Develop new job roles/functions
- 2) Talent management (prevent intellectual capital drain)
- 3) Rationalize redundant services (e.g., HR, finance, benefits, etc) - maybe employ Total Rewards practice
- 4) Establish the culture of the new organization (not a merger of equals, but the acquired company should not feel like they are losing their identity/culture) through leadership, training, communications, etc.
- 5) Develop and implement appropriate incentives.

Case 20: Edoceo

Human Capital: Outsourcing

Deloitte

Prompt

Edoceo is a leading global provider of integrated information solutions to business and professional customers. Customers depend on Edoceo for the information and information applications they need to make the right decisions to run their businesses. Edoceo provides information solutions for professionals across a broad range of industries and disciplines.

Edoceo decided to outsource select HR processes including: Recruiting, Benefits Admin, HRIS, HR Admin, L&D, Compensation, Domestic Relocation, Expatriate Admin, Payroll, HR Contact Center. Edoceo is working with one of Deloitte's competitors to implement the outsourcing transition. The initiative's objective is to realize cost savings of 10%-20% of total current annual costs over five years, while maintaining equivalent levels of service.

In parallel, Edoceo intends to transform the retained HR organization, creating internal Centers of Excellence (COE) and developing HR Business Partners to support with outsourced services. Edoceo has hired your team to provide best practice guidance and implementation leadership. How would you design and implement optimal COEs and HR business partner capability for this organization and how would you structure the project? How would you describe a successful outcome for this project?

Note about nature of the Case: This is a Human Capital Case and thus contains an approach much different from the usual "Strategy" case. However the candidate should not abandon the use of a framework. Here the focus isn't so much on the bottom line as it is on the approach needed to manage the proposed changes in the organization. The case should be carried out in a conversational format with hints and clues to push the candidate alongside the case prompt.

Guidance

- *There was a cost reduction effort that the organization was undergoing that required an evaluation and shift in HR support. Finance and IT were to follow.*
- *Inefficiency and complexity of the existing HR organization were the driving forces of the outsourcing.*

Case 20: Edoceo

Human Capital: Outsourcing

Deloitte

<p>Guidance</p>	<ul style="list-style-type: none"> ▪ <i>The functions intended for COEs are: Benefits, Compensation, Recruiting, Talent Management, HR Decision Support, L&D, Org Development, Diversity, and Policy, Compliance and M&A.</i> ▪ <i>There is no current assessment of the HRBP role today, and each Market Group runs its own entity. The vision for the HRBP is to be: provide business unit specific and consultative services to executives and line managers for the people-related issues</i> ▪ <i>Impacting their business unit. Business Partners “broker” technical talent from the COEs to deliver HR solutions.</i> ▪ <i>Considerable job redesign and capability assessment will be conducted for retained positions</i> ▪ <i>There is significant concern among staff in retained functions about the long term safety of their jobs</i> <p><i>Candidate should discuss the business perspective and specifically the role of retained HR in an outsourced environment.</i></p>
<p>Analysis</p>	<p><u>How to structure project:</u> Follow some type of Plan, Build, Run approach, for example:</p> <p>Plan & Assess</p> <ul style="list-style-type: none"> ▪ As-Is Inventory ▪ Define staffing strategy COE & Business Partner strategy ▪ Reporting & metrics strategy ▪ Stakeholder analysis ▪ Change readiness assessment ▪ Communication and change strategy <p>Design</p> <ul style="list-style-type: none"> ▪ Process design, COE and Business Partner development ▪ Build communication, change and training materials and implementation plan <p>Build & Implement</p> <ul style="list-style-type: none"> ▪ Build out process designs and COE structure ▪ Deliver training materials for the new positions and processes <p>Support & Integrate</p> <ul style="list-style-type: none"> ▪ Ensure effective interactions with outsourced functions and larger organization

Case 20: Edoceo

Human Capital: Outsourcing

Deloitte

<p>Prompt— Part II</p>	<p>Ask the candidate following question:</p> <p>What else should Edoceo be considering as it implements the outsourcing and development of the COEs?</p>
<p>Guidance</p>	<p><i>Let the candidate deliberate and answer this question. There is not much information to be given to the candidate.</i></p>
<p>Analysis</p>	<p>Apart from other considerations the candidate should touch upon these:</p> <p><i>How to prevent/deal with: Service disruption, Performance/morale issues, Attrition (loss of key talent), Links to other initiatives</i></p>
<p>Performance Evaluation</p>	<p>Expected: The candidate touches upon all the major points recognized in this case.</p> <p>Good: The candidate not only touches upon all the major points but also provides his/her analysis and reasoning behind those considerations in a structured way with use of a framework.</p> <p>Excellent: The candidate explains all the scenarios in a well-planned, structured and thoughtful manner providing logical reasoning behind his/her statements. The candidate also provides good explanation for the question in Part II and shows in-depth understanding of the change management process and human capital concepts.</p>

Case 21: Smith Financial CRM

Human Capital: CRM

Deloitte

Prompt

A major U.S. financial services company has just implemented a Client Relationship Management (CRM) system. The goal: To give leadership a real time view into the organization's sales channel.

For years, sales teams have maintained client sales information in separate excel spreadsheets. This prevented leadership from having visibility into and a holistic view of sales opportunities, which meant sending multiple requests to sales teams for the latest and greatest information. By the end of fiscal year, all sales teams are expected to migrate their sales data onto this new system, and use it to manage all sales information.

You are the change management lead for this project. How would you get everyone on the system? Who are the various stakeholders? How would you communicate to these stakeholders?

Note about nature of the Case: This is a Human Capital Case and thus contains an approach much different from the usual "Strategy" case. However the candidate should not abandon the use of a framework. Here the focus isn't so much on the bottom line as it is on the approach needed to manage the proposed changes in the organization. The case should be carried out in a conversational format with hints and clues to push the candidate alongside the case prompt.

Guidance

Here are some guiding questions that will help the candidate analyze the situation:

- 1) Who will be affected by this change?*
- 2) What are some ways that you can think of to best announce/communicate this change? Is it a single person's role, or should multiple individuals of different capacities be involved?*
- 3) Do you think everyone will be happy with this change? How will you handle dissention?*

Case 21: Smith Financial CRM

Human Capital: CRM

Deloitte

<p>Analysis</p>	<ul style="list-style-type: none"> ▪ Definition of Stakeholders: Leadership, Sales teams, & the rest of the organization ▪ Find out how people in organization like to receive communications ▪ Identify a change champion (leads one-on-one sessions) ▪ Technical support/training: how to contact the help desk ▪ Create a central place for feedback/comments ▪ Create honest communications (share both the bad and the good) ▪ Generate excitement/ engagement through a fun and well- branded communications campaign (all communications/ marketing should use this brand/identity) ▪ CEO Webcast (announcing the change initiative)
<p>Prompt— Part II</p>	<p>Do you see any other change issues? How would you address them?</p>
<p>Guidance</p>	<p><i>Here are some guiding questions that will help the candidate analyze the situation:</i></p> <ol style="list-style-type: none"> 1) <i>How do you think on-boarding will work? Will people automatically know how to use the system?</i> 2) <i>How will we keep people using this new system? What is the benefit to them? (if candidate struggles, mention the word 'incentivize' or 'benefit')</i> 3) <i>How do we know we made the right decision in making these changes?</i>
<p>Analysis</p>	<ul style="list-style-type: none"> ▪ Training (web based and classroom based) for sales team and technical support ▪ Design and implement incentives/ tie to Performance Management ▪ Create success metrics

Case 21: Smith Financial's CRM

Human Capital: CRM

Deloitte

<p>Prompt— Part III</p>	<p>How do you measure success? What do you do if leadership digs in their heels and resists the change? <i>(After the candidate answers that question, please follow-up with the following question and change the direction of the case)</i> Now, let's change things up. Say the system was implemented - without the help of change management - and it failed (i.e., the people have not adopted the new technology). The team brings you on to salvage the project. What would you do?</p>
<p>Guidance</p>	<p>1) <i>When/how will you set goals for the outcome of this project?</i> 2) <i>How would you respond if senior management calls you into a meeting to tell you that they refuse to use this new system?</i></p>
<p>Analysis</p>	<ul style="list-style-type: none"> ▪ Set measurable goals at the onset of the project: ex. 75% usage by the end of the project, reduce number of manual excel reports by 50% within the first 3mo of the CRM launch ▪ Share with management the other projects that can now be tackled to improve company performance, now that less time is being spent on maintaining excel spreadsheets.
<p>Performance Evaluation</p>	<p><i>Ask the candidate to synthesize all information analyzed in case</i></p> <p>Expected: The candidate will recognize that this change affects employees at all levels of the organization and will plan the change accordingly. Good: The candidate will touch on the major points mentioned. Excellent: The candidate will acknowledge and preemptively address and lay out a contingency plan in the event that the CRM rollout does not go as planned.</p>

Case 22: F2D Electronics

Human Capital

Deloitte

Round 1

Prompt

Problem Definition: Your client is the nation’s largest distributor of electrical and communications products. The 150-year old company distributes more than one and a half-million products (1.5 million SKUs) made by multiple manufacturer/suppliers through 256 branches and warehouses in the US. Given that they are the middle-men, margins in the distribution industry are very thin. F2D has been generally decentralized with a high degree of branch autonomy (branch and district managers are kings of their own domain). Each branch has its own processes with considerable off-system accounting and record keeping on Excel spreadsheets, etc. Given growth over the last decade, the home-grown mainframe computer system can no longer effectively handle the volume of transactions. In addition, the time required to reconcile and report sales, inventory, and financial information from the branches to corporate is hindering senior management’s ability to make timely business decisions. To address these issues, the client is undertaking a major business transformation program. They will reengineer most business processes (sales, marketing, forecasting, logistics, finance, customer service) and are implementing one system for everyone in the company that will provide real-time information and a 360 degree view of the business. Senior management anticipates a high degree of resistance from the branches. Branch leadership feels the system and processes from corporate will not understand their needs and threatens their autonomy. Past initiatives have struggled because people were not adequately prepared for the changes. Employees are worried about how their jobs will change and whether they will have the skills to do their jobs within the new system.

Question: How would you assist the client to successfully manage this large scale change program?

Note about nature of the Case: This is a Human Capital Case and thus contains an approach much different from the usual “Strategy” case. However the candidate should not abandon the use of a framework. Here the focus isn’t so much on the bottom line as it is on the approach needed to manage the proposed changes in the organization. The case should be carried out in a conversational format with hints and clues to push the candidate alongside the case prompt.

Guidance

Note: Remember that this case is intended to be carried out in a conversational manner.

Case 22: F2D Electronics

Human Capital

Deloitte

Round 1

Analysis

- Leadership Alignment and Visibility/Sponsorship: Facilitate leadership at corporate to “sing from the same page.” Then, enable corporate leadership to engage district and branch leaders. Clearly explain why the changes are required in the competitive business environment, why their leadership is needed and how they will be rewarded. In times of large scale changes, there should be a high degree of leadership visibility.
- Buy-In: Employees need to know that their leaders (at corporate and branches) are behind this effort and they need to hear this directly from their leaders. Provide talking points and support to make it easier for them to communicate to employees.
- Communications: Develop a comprehensive communication strategy for internal and external audiences. Explain to employees the business case for change, “what is in it for them,” and how their jobs will change. Communications should be timely and consistent to stem rumors. Similarly, there should be a communications strategy for suppliers and customers to explain how service will improve to assure them there will be no disruptions.
- Workforce engagement: Engage employees from as many branches as possible in the design and implementation of the new process and system. Gather input on their business requirements throughout the lifecycle of the project. Conduct roadshows out to the branches. Use trainers from each of the branches to train end users. Engage branches and employees so they take ownership of the system.
- Organizational Reinforcement/Incentives: Make sure those who are providing input, championing and adopting the system are recognized, rewarded, and utilized as change agents.
- Training: Profile how jobs will change and train employees thoroughly on the new process and system. Hands-on training close to the launch and relevant to employees’ jobs tends to be most effective.

Case 22: F2D Electronics

Human Capital

Deloitte

Round 1

Performance Evaluation

Expected:

The candidate touches upon all the major points recognized in this case.

Good:

The candidate not only touches upon all the major points but also provides his/her analysis and reasoning behind those considerations in a structured way with use of a framework.

Excellent:

The candidate explains all the scenarios in a well-planned, structured and thoughtful manner providing logical reasoning behind his/her statements. The candidate also provides good explanation for the question in the prompt and shows in-depth understanding of the leadership, alignment and buy-in process as well as Human Capital concepts.

Case 23: Sunique Human Capital

Human Capital

Deloitte

Round 1

<p>Prompt</p>	<p>Your client is faced with dramatic changes in the industry. As it adjusts its strategy, reacts to changes and anticipates future changes, it is concerned about its ability to keep its employees prepared for the challenges they will face. The client is also concerned about its traditional approach to learning and development and has questions about the return on investment of its programs.</p> <p>Your team was retained to help assess the effectiveness of the organizations learning center, develop a go forward learning strategy, and to select and implement an “appropriate” enterprise learning management system (LMS) solution that will allow the client’s learning center to successfully execute its learning strategy while simplifying its operational processes and allowing it to scale for future growth.</p> <p>What approach would you take to assessing the client’s current learning capabilities and developing the go forward strategy? What issues would you consider regarding the selection and implementation of the Learning Management System?</p>
<p>Guidance</p>	<p>Make sure that the candidate understands that you are looking at qualitative analysis and not a quantitative analysis.</p> <p>Look for a good framework that is logical and sound.</p>

Case 23: Sunique Human Capital

Human Capital

Deloitte

Round 1

<p>Analysis</p>	<p>Review current learning activities - balance of instructor-led training, e-Learning, and other learning methods</p> <ul style="list-style-type: none"> ▪ Degree of learning assessment used (Reaction, Learning, Transfer, Results) ▪ Meet with leadership to determine requirements of new strategy ▪ Review individual learning plans ▪ Skill gap analysis ▪ Assess ability of existing programs to address needs, identify needs for additional learning programs ▪ Specific system selection and implementation components candidate may consider: ▪ Integration with HRIS system ▪ Data migration, system configuration, and interface development ▪ Self-service registration ▪ Degree of network vs. remote access ▪ Scalability
<p>Performance Evaluation</p>	<p>Expected: At a minimum, the candidate should touch on the major points and be comfortable in discussing other aspects of the case when gently guided by interviewer.</p> <p>Good: A good candidate will touch all the major points and require a small amount of guidance to cover all aspects of the case.</p> <p>Excellent: The excellent candidate will touch all the key points with little to no guidance, be comfortable and confident in discussing the major points of the case, and develop a framework for implementation.</p>

MARKET ENTRY

Case 24: Professional Car Racing

Market Entry

Accenture

Round 2

<p>Prompt</p>	<p>Your client is the owner of UPS #88, a racecar on the NASCAR tour. It races in the Nextel Cup, a points-based championship where the season winner has accumulated the most points over the course of the racing season.</p> <p>There are 36 races in total, running from February to November. Dale Jarrett, a well-known celebrity driver, races for the team. Dale helped win the Nextel Cup three years ago, and so far this year is eighth in a field of 43 drivers.</p> <p>A close friend who is the VP of marketing at Home Depot recently contacted the client. She inquired about sponsoring a second racing team with the client. She recognizes that NASCAR is the fastest growing segment among males ages 18-45. She also has talked to a successful driver from a regional drag racing circuit to try out as the driver of the team.</p> <p>Evaluate the potential of this opportunity.</p>
<p>Guidance</p>	<p><i>The candidate should present an overview of his/her approach to the case and develop a framework. A profitability analysis should follow, with the candidate requesting revenue and cost information. Interviewer should probe candidate on the sources of revenue in this market before providing the following information.</i></p> <p>Revenue information: included in Exhibit 1; before giving to candidate, ask what revenue buckets they can think of, then give remaining</p> <p>Cost information: included in Exhibit 2; before giving to candidate, ask what cost buckets they can think of, then give remaining</p>

Case 24: Professional Car Racing

Market Entry

Accenture

Round 2

<p>Analysis</p>	<p>Revenue – Give candidate Exhibit 1 after buckets are outlined \$50K-1000K per race winnings. Assume average of 200K (other assumptions are ok) 36 races per year. Assume driver qualifies for 30. →\$200K*30 = 6000K or 6M</p> <p>Race winnings are 25% of total revenue →6M / .25 = 24M total revenue</p> <p>Cost - Give candidate Exhibit 2 after buckets are outlined Tell candidate that total costs are \$20M</p> <p>Profit 24M – 20M = 4M profit</p>
<p>Guidance</p>	<p><i>Since total revenue is not given, the candidate should recognize that the only way to calculate it from the revenue information given is by estimating total race winnings and extrapolating based on the percentage of total that these represent.</i></p> <p><i>After being told the total costs, the candidate should revisit the revenue estimation and adjust the average winnings assumption, if necessary (e.g. 100K avg would be unrealistic loss, while 500K average would be unrealistic profit)</i></p>

Case 24: Professional Car Racing

Market Entry

Accenture

Round 2

<p>Analysis</p>	<p>Marginal cost of adding a new team Total Costs = \$20M Race-facing costs = $40\% / 2 * 20M = \\$4M$ Equipment costs = $25\% * 20M = \\$5M$ Travel costs = $5\% * 20M = \\$1M$</p> <p>→Marginal costs of adding new team = $4+5+1 = \\$10M$</p>
<p>Guidance</p>	<p><i>The candidate should now turn his/her attention to the cost of adding a new team. If interviewer observes that the candidate needs direction, prompt him/her by asking: "What is the minimum amount of money that the client should ask for from Home Depot?"</i></p> <p><i>Information to be given with respect to adding a new team.</i> <i>The costs affected w.r.t. addition of a new team are Salaries, Equipment, and Travel. The other two cost components are associated with the engine shop.</i> <i>Specifically,</i></p> <ul style="list-style-type: none"> ▪ <i>Race-Facing costs will double</i> ▪ <i>Equipment costs will double</i> ▪ <i>Travel costs will double</i>

Case 24: Professional Car Racing

Market Entry

Accenture

Round 2

<p>Prompt – Part II</p>	<p>Should the client charge a premium to Home Depot for sponsorship?</p>
<p>Analysis</p>	<p>Option 1: Yes, we should charge a premium — Home Depot seems to have already made some commitment to the deal by conducting initial negotiations with the potential driver. Therefore client has bargaining power. Premium can be justified by providing Home Depot with an acceptable Return on Investment analysis.</p> <p>Option 2: No, we should not charge a premium —Home Depot has several other options to sponsor, including 1) another race team, 2) another sport (e.g., baseball), 3) another racing circuit (e.g., Formula One)</p>
<p>Guidance</p>	<p><i>Potential for charging premium – The interviewer should ask candidate to evaluate the possibility of charging a premium to Home Depot for the sponsorship. Note that there is no right/wrong answer here; rather interviewer should evaluate response basis candidates’ rationale.</i></p> <p><i>Multiple answers are acceptable here. This answer key is not exhaustive.</i></p> <p><i>After this question, ask candidate to wrap up case.</i></p>

Case 24: Professional Car Racing

Market Entry

Accenture

Round 2

Performance Evaluation

Expected:

- Accurate arithmetic
- Profitability framework

Good:

- Identify need to calculate marginal cost of new team

Excellent:

- Candidate discusses risks of adding new team. For example,
 - Other potential points include the natural tension between adding a new team and the allocation of resources (e.g., high quality mechanics from Dale's team may work with the Home Depot car, thus diluting the quality of performance of Dale).
 - Potential risks certainly include adding a new driver who has only drag racing experience. This driver would probably not contribute to merchandising revenue, due to his relative anonymity.
- Candidate discusses validity of cost assumptions for new team. For example,
 - There is some validity, however, to the point that salaries for the new team may be lower because the new driver lacks the name recognition of Dale Jarrett.
 - The total cost of equipment may be lower than average due to the ability to leverage the engine shop technology. Some candidates might recommend closing the engine shop, but we have no margin information to substantiate this.

Case 24: Professional Car Racing

Market Entry

Accenture

Round 2

Exhibit 1

Revenue Sources	% of Revenues	Description
Sponsorships	60%	UPS dominates, other sponsors include Outback Steakhouse and 3M
Nextel Cup Race Winnings	25%	One can win from \$50K - \$1MM depending on how one finishes and the significance of the particular race
Selling Engines	10%	Strong R&D shop. Engines are sold to professional drivers domestically
Merchandising	5%	License out production to third-party. T-shirts and caps are a small revenue source

Case 24: Professional Car Racing

Market Entry

Accenture

Round 2

Exhibit 2

Revenue Sources	% of Costs	Description
Salary	40%	'Race-facing' costs make up 50% (Mechanics and Dale Jarrett); 'Non race-facing' costs make up the remaining 50% (engine shop technicians, HR, accounting etc)
Equipment	25%	Race cars, engines, parts (sheet metal)
Travel	5%	Getting to and from races
Leisure, engine shop	10%	Leasing of land in rural North Carolina
R&D	20%	Engine shop technology improvements

Case 25: Lizette's Luxury Properties

Market Entry

A.T. Kearney

Round 1

<p>Prompt</p>	<p>Your client is a real estate developer, Lizette's Luxury Properties, and is currently assessing a new project idea in Costa Rica. Costa Rica has a beautiful coastline which has historically been difficult to access. The nearest airport was over six hours away. As of last year, a new airport was constructed only a half hour away. There has been an investment boom in the region due to the increasing number of tourists (popular with Americans and Asians). The Mandarin Oriental and The Four Seasons, two prominent luxury hotel chains, were the first to enter this market with a 250-room hotel each. Should your client invest in the tourism opportunity created by the new airport? Would you recommend that s/he enter the market?</p>
<p>Guidance</p>	<p><i>The framework developed by the candidate may explore a variety of issues including: Core Competencies, Market Attractiveness, ROI, and Project Success Factors. Here is some information that will help the candidate analyze the situation:</i></p> <p><u>Client's Core Competencies:</u></p> <ul style="list-style-type: none"> - The client has focused on hi-rise apartments (50%) and luxury condominiums (50%) in the past but wants to enter the hotel arena. - They have focused on world-class beaches, such as Playa del Carmen, Marbella, Coral Beach, Tahiti, Fiji, Maldives, Mikonos, etc. <p><i>*The key insight here is that the client has past experience in construction of a similar type, but has no direct experience in the hotel industry or service operations. Additionally, the client probably has good judgment in spotting travel locations and has a successful track record with the construction of prime properties.</i></p>

Case 25: Lizette's Luxury Properties

Market Entry

A.T. Kearney

Round 1

<p>Guidance</p>	<p><u>Market Attractiveness / Five Forces Analysis</u></p> <ul style="list-style-type: none"> ▪ Market size - 875,000 tourists per year (assume 350 days in a calendar year) ▪ Average duration of stay per tourist - 4 nights ▪ Average hotel check - \$2,000. ▪ Others - In terms of tourists, you depend on government spend on advertising, on travel agents, and on the network effect of the existing hotels in the area. ▪ Competitiveness - Other hotels chains that are thinking of entering the market are Starwood, Peninsula, and Imperial Hotels. ▪ Supplier Power - The local labor market offers a huge supplier of workers (very positive) ▪ Substitutes - You are fighting with every other "paradise-type" destination, from Disneyland to Vegas to Bermuda. Interest in this area, however, is sky high. ▪ Barriers to Entry - Government regulations, high capital requirements, unavailable beachfront property. ▪ Buyer Power – The recent consolidation among travel agencies and proliferation of e-vendors put buyers in a powerful position.
<p>Analysis</p>	<p>Quantitative takeaway: $3.5 \text{ million tourist nights} / 350 \text{ days} = 10,000 \text{ tourists / night}$ $\\$2,000 \text{ average check} / 4 \text{ days average stay} = \\$500/\text{night}$</p> <p>Qualitative takeaway: Despite the competitive nature of the market it is large enough to be profitable, and client has desired capabilities to successfully compete. The level of resources required would be a barrier to entry and maybe there are others that need to be investigated--such as government permits, access to sewage, water, etc.</p>

Case 25: Lizette's Luxury Properties

Market Entry

A.T. Kearney

Round 1

<p>Guidance</p>	<p><i>ROI Analysis – If the candidate brings up ROI, tell them that client has already short listed three available lots. Ask him/her to recommend one of the three such that Return on Investment is maximized?</i></p> <table border="1" data-bbox="446 411 1727 678"> <thead> <tr> <th></th> <th>Land Cost</th> <th>Cost/Room</th> <th>Operating Cost</th> <th>Room Capacity</th> <th>Price/Night</th> </tr> </thead> <tbody> <tr> <td>Lover's Lair</td> <td>\$2 MM</td> <td>\$30 K</td> <td>\$250</td> <td>500</td> <td>\$450</td> </tr> <tr> <td>Paradise Lost</td> <td>\$4 MM</td> <td>\$28 K</td> <td>\$200</td> <td>1000</td> <td>\$400</td> </tr> <tr> <td>Fookwah Heights</td> <td>\$6 MM</td> <td>\$25 K</td> <td>\$150</td> <td>1500</td> <td>\$350</td> </tr> </tbody> </table> <ul style="list-style-type: none"> • Average occupancy 50% • No. of operating days in a year: 350 • Operating expenses are 100% variable • At ROI 10%, company target is to recover investments within one year 		Land Cost	Cost/Room	Operating Cost	Room Capacity	Price/Night	Lover's Lair	\$2 MM	\$30 K	\$250	500	\$450	Paradise Lost	\$4 MM	\$28 K	\$200	1000	\$400	Fookwah Heights	\$6 MM	\$25 K	\$150	1500	\$350
		Land Cost	Cost/Room	Operating Cost	Room Capacity	Price/Night																			
Lover's Lair	\$2 MM	\$30 K	\$250	500	\$450																				
Paradise Lost	\$4 MM	\$28 K	\$200	1000	\$400																				
Fookwah Heights	\$6 MM	\$25 K	\$150	1500	\$350																				
<p>Analysis</p>	<p><u>ROI Analysis:</u> ROI = Profit/Investment. Revenue = Revs per night * number of nights * number of rooms * nights per year * occupancy rate</p> <p>Option 1: Lover's Lair</p> <ul style="list-style-type: none"> • Operating Profits: ((((\$450 revenue – 250 operating costs) * 500 rooms) * 350 nights/year) * 50% occupancy rate) = \$17.5 million operating profits/year (a) • Initial Investment: 30,000 cost/room * 500 rooms + \$2,000,000 land = \$17 million (b) • Net Profit: (a)-(b) = \$500,000 (c) • ROI: (c) / (b) = \$500,000/17 million = 2.9% 																								

Case 25: Lizette's Luxury Properties

Market Entry

A.T. Kearney

Round 1

<p>Analysis</p>	<p><u>ROI Analysis (Continued):</u> Option 2: Paradise Lost</p> <ul style="list-style-type: none"> • Operating Profits: $((((\\$400-200) * 1000) * 350) * 50\%) = \\35 million • Initial Investment: 28,000 cost/room * 1000 rooms + \$4 million land = \$32 million • ROI: $\\$3,000,000 / \\32 million = 9.4% <p>Option 3: Fookwah Heights</p> <ul style="list-style-type: none"> • Operating Profits: $((((\\$350-150) * 1500) * 350) * 50\%) = \\52.5 million • Initial Investment: $\\$25,000 * 1,500$ rooms + \$6 million land = 43.5 million • ROI: 9 million / 43.5 million = 20.7%
<p>Guidance</p>	<p><i>Factors determining project feasibility – Ask the candidate to list factors to be considered in determining the feasibility of the project</i></p>
<p>Analysis</p>	<p><u>Good Concerns:</u> Competition (what are they focusing on? will it flood the market?) Strategy (Where will you compete--low cost, high service, best in class, packages?) How should the developer finance the building? Since the hotel will bring jobs maybe the government can help with some tax deductions, free services, etc...</p> <p><u>Great Concerns:</u></p> <ul style="list-style-type: none"> •How can they leverage their experience, what values from their other business can they leverage? •Would they manage the hotel or build it and then find an operating partner like Starwood or Hilton? •What are the existing barriers to entry, how would you change them to insure a greater degree of success?

Case 25: Lizette's Luxury Properties

Market Entry

A.T. Kearney

Round 1

<p>Final Prompt</p>	<p>After the candidate offers his/her insights, tell him/her to focus on ROI first with the room prices specified in table and then with the market room price (\$500).</p> <p>Finally: Ask the candidate to conclude the case with a “go/no go” decision, supporting it with the insights drawn through out the case. Probe into additional concerns the client needs to address.</p>
<p>Performance Evaluation</p>	<p>Expected: Candidate will develop a structured framework that touches on some if not all of the categories described. Candidate will exhibit accurate arithmetic in ROI analysis.</p> <p>Good: The candidate will be able to provide the qualitative takeaways regarding market attractiveness and/or core competencies.</p> <p>Excellent: In addition to the above, the candidate will also identify the key concerns regarding the project feasibility and provide a go/no go decision with supporting evidence from insights drawn from the case.</p>

Case 26: Napoleon's Pizza Pies

Market Entry

DMCC

Round 1

<p>Prompt</p>	<p>Napoleon's Pizza Pies ("Pizza fit for an Emperor") has recently tried to establish the best home pizza delivery business in Paris. Pizza Hut, however, has a virtual monopoly on the pizza home delivery market. Napoleon's has asked your consulting firm to analyze the issues that will determine the likelihood of successful entry in the Parisian pizza market.</p> <p>What information would you need and how would you analyze the pizza delivery market?</p>
<p>Guidance</p>	<p>1) Candidate needs to estimate the size of the Parisian home pizza delivery market. If the candidate asks for market information, introduce <u>Exhibit 1</u> and <u>Exhibit 2</u>.</p> <p>2) Other information available upon request:</p> <ul style="list-style-type: none"> ▪ Percentage of Pizza Hut's business that is delivery is ~50% ▪ Almost 90% of deliveries take place outside the city centre ▪ City centre Pizza Hut stores offer predominantly restaurant service ▪ The market for pizza is growing at 5% annually. The submarket for pizza delivery is growing at 8% <p>3) Candidate should do a market sizing, market attractiveness and segmentation and then look at the cost structure of the industry to find a potential competitive advantage.</p>
<p>Analysis</p>	<p><u>Overall Pizza Delivery Market:</u> $50\% \text{ of business is delivery } \times [\\$1.2\text{M} / \sim 90\% \text{ market share}] = \\667k</p> <p><u>Of that, city centre's delivery market is:</u> $\\$667\text{k} \times 10\% \text{ of delivery business is done in city centre} = \\67k</p>

Case 26: Napoleon's Pizza Pies

Market Entry

DMCC

Round 1

<p>Performance Evaluation</p>	<p>Expected: It is expected that all candidates will complete a market sizing with realistic assumptions and a basic market and cost analysis (similar to what is provided above).</p> <p>Good: Good candidates will remember that Pizza Hut has a virtual monopoly position in home delivery but that the market for the city centre seems underserved. A good candidate will also ask for and identify the different growth rate of the delivery market versus the pizza market in general.</p> <p>Excellent: Excellent candidates will complete a market sizing and quickly move into a complete industry analysis for market segmentation and cost structure understanding. The candidate will identify the opportunity in the city centre market and identify the low barriers to entry for Pizza Hut in that market. The candidate should also consider that the execution of the delivery service may have more complexity within a market like city centre.</p>
<p>Prompt— Part II</p>	<p><u>Follow up prompt for Good & Excellent candidates:</u> Napoleon launches his pizza delivery business and wins a customer service award. Pizza Hut responds (Show <u>Exhibit 3</u>). What should Napoleon do?</p> <p>Napoleon calls you from his moped for answers. What can you tell him?</p>
<p>Guidance</p>	<ol style="list-style-type: none"> 1) <i>Candidate should consider price war implications and Pizza Hut's position as a near monopoly in the market</i> 2) <i>Determine if there are considerable differences in cost or quality of delivery service for Napoleon</i>

Case 26: Napoleon's Pizza Pies

Market Entry

DMCC

Round 1

Performance Evaluation

Expected:

Recognize the potential for a price war with Pizza Hut and explain implications

Good:

Good candidates will identify Pizza Hut's reaction as an over-reaction based on their position in the market. The candidate should avoid the price war in his recommendations and potentially focus on key products or sub-segments of the city centre segment.

Excellent:

Excellent candidates will identify the over-reaction and look for ways to take advantage of this strategic mistake made by Pizza Hut. The candidate should probe about any substantial differences between the quality and speed of delivery for Napoleon and look to exploit any of them. Ultimately, the candidate should recommend that Napoleon continue to focus on the premium market and continue to execute on points of differentiation like customer service.

Case 26: Napoleon's Pizza Pies

Market Entry

DMCC

Round 1

Exhibit 1

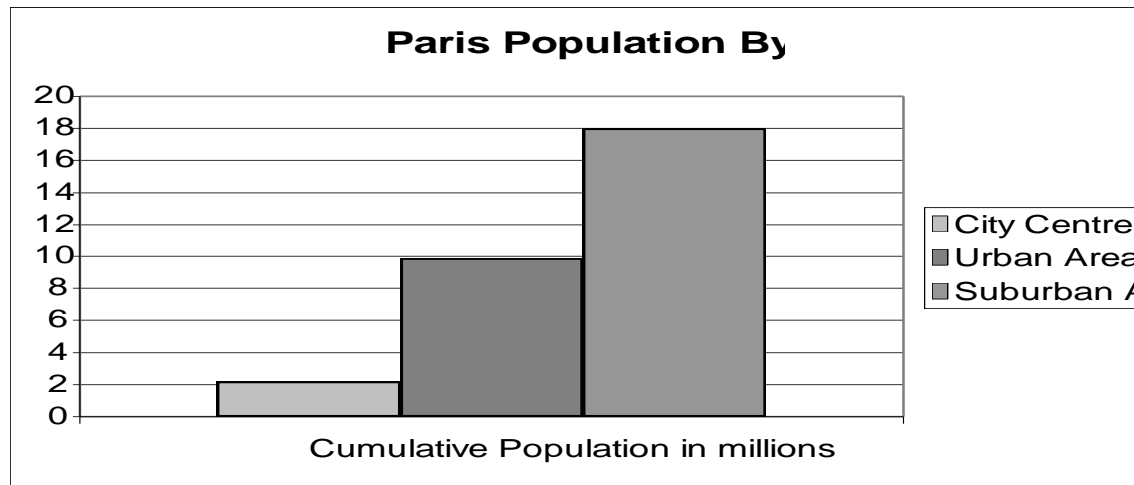

Exhibit 2

Pizza Hut Information	
Sales in millions (Pizzas)	1.2
Stores	95
Market Share	85-95%
Market Segments, % of sales	
Paris City	20%
Metropolitan Areas	35%
Paris Suburban Areas	45%

Case 26: Napoleon's Pizza Pies

Market Entry

DMCC

Round 1

Exhibit 3

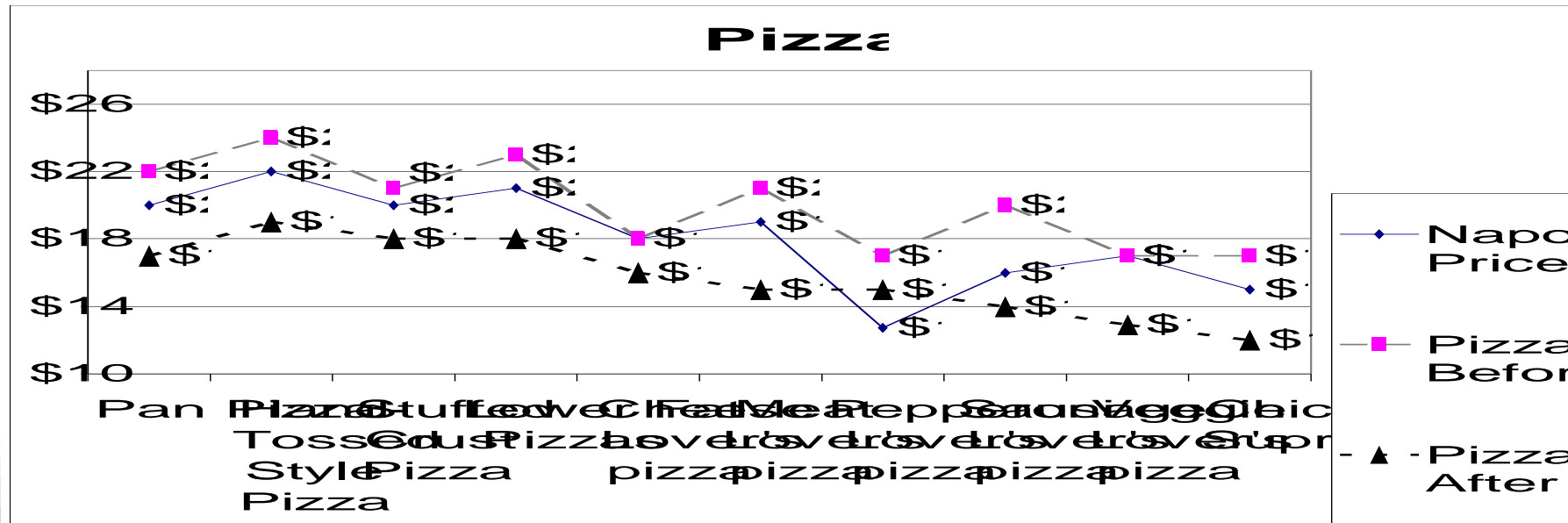

Case 27: K. Grace Hospital Chain

Market Entry: Entry / Exit Decision

McKinsey & Co.

Round 1

<p>Prompt</p>	<p>Your client is a large hospital chain, K. Grace. There have been proposed legislation changes to Medicare that will affect your client. For example, some surgeries will no longer be reimbursable at the same rate. As a result, this has caused the hospital to consider a strategy that would shift its focus toward less profitable surgeries by using alternative therapies. However, the client is concerned about the decreased revenue potential from this proposed shift in strategy.</p> <p>Currently the client has a \$4 billion top line. Surgeries represent half of this total. Half of the hospitals in the chain perform all of these surgeries. For this case, let's say that all patients are on Medicare (private insurance is not a factor). Should we close part of the chain? All of the chain? None of the chain? What drivers will help us arrive at a close / no close decision?</p>
<p>Guidance</p>	<p><i>Allow the candidate some time (<1.5 min) to create a structured framework.</i></p> <p><i>Some issues to discuss could be the profitability (revenues and costs) of the surgeries. Look for a basic framework that includes a revenue breakdown into prices and quantities and a simple cost structure with fixed and variable costs.</i></p> <p><i>Next, ensure that the candidate is considering the percentage of surgeries that is actually impacted.</i></p> <p><i>Prompt the candidate by asking: Maybe we should explore whether the hospital chain has any capabilities in providing alternative therapies—could we make money there?</i></p> <p><i>Let's see external things, too, like the ability to influence the regulatory environment, the needs and preferences of our end users (would they pay out-of-pocket?).</i></p> <p><i>Lastly, the candidate should not fail to address the strategies competitors are adopting.</i></p>

Case 27: K. Grace Hospital Chain

Market Entry: Entry / Exit Decision

McKinsey & Co.

Round 1

<p>Guidance</p>	<p><i>Steer the candidate toward profitability information. What does he/she want to know? Allow the candidate to make assumptions regarding profitability (guide them if their assumptions are way off base). This case is not about the specific numbers, rather the analysis conducted.</i></p>
<p>Analysis</p>	<p>Typical impacted hospital (annual): Patients: 1,000 Price (revenue) per patient: \$1,000 Cost per patient: \$800 Fixed Cost of facility: \$100,000</p> <p><i>If the candidates numbers are very different, suggest they use the numbers provided above for simplicity.</i></p> <p>Simple breakeven calculations should be made—The hospital must serve at least 500 patients to remain open. Each patient delivers a \$200 contribution margin.</p>
<p>Prompt— Part II</p>	<p>How many patients would you have to lose below breakeven (500) to close the hospital?</p>
<p>Guidance</p>	<p><i>The candidate needs information on the cost of exiting the business. Let them ask for it. Once they request the information, you can give them the following: The exit cost is \$50,000.</i></p>
<p>Analysis</p>	<p>The profitability over time, discounted back to today, minus the PV of the exit costs, should equal zero to breakeven: $Q \times \\$200 - \\$100,000 = -\\$50,000$. $Q = 25$</p> <p>Another way to look at this is the value of lost customers to the business over time, taken as a perpetuity. Or, $\text{loss} / \text{hurdle rate} = \text{exit cost}$. Assume a discount rate of 10%.</p> <p>$\text{Loss} / .10 = 50,000$. $\text{Loss} = \\$5,000$, which equals 25 patients that you would have to lose below breakeven to close the hospital. $500 - 25 = 475$ patients to remain open</p>

Case 27: K. Grace Hospital Chain

Market Entry: Entry / Exit Decision

McKinsey & Co.

Round 1

<p>Prompt— Part III</p>	<p>If fixed costs change to \$150,000, how many patients will you need to break even? How many patients would you have to lose to close the hospital?</p>
<p>Analysis</p>	<p>$\\$150,000 / \\$200 = 750$ patients to stay open $\text{Loss} / .10 = \\$50,000$. The loss of future value that one gives up by incurring the exit costs equals 25 patients. Below 725 patients, the facility should close.</p>
<p>Prompt— Part IV</p>	<p>The hospital does some research and finds that 3/8 of its surgeries will not be reimbursable. A government report says it will save 6-9% by passing the new legislation. You know that someone has botched the research. How is the information contradictory?</p>
<p>Guidance</p>	<p><i>The candidate should ask for the national market share of the company. Otherwise, the data above is like comparing apples to oranges.</i></p> <p><i>The market share for your client is 20%.</i></p> <p><i>This means that, according to your client, 7.5% ($.375 * .20 = .075$) of the government savings will come from its surgeries, which represent only 20% of the total national market.</i></p>

Case 27: K. Grace Hospital Chain

Market Entry: Entry / Exit Decision

McKinsey & Co.

Round 1

Performance Evaluation

Candidate should provide a crisp recommendation – By McKinsey standards, a crisp recommendation should be roughly 30 seconds long and should include clear bullet points that support an overall recommendation. For example, “Close the chain for reasons 1, 2, and 3.”

Expected:

- Accurate arithmetic
- Solid profitability and breakeven calculations

Good:

- Framework that includes exploration of all possible options
- Clear recommendation that summarizes key findings in under 30 seconds

Excellent:

- Considered possibility of alternative therapy surgery market entry
- Understanding of, and clear answer to, the final question (Note: this question is very complicated)

Case 28: Stew's Connections

Market Entry

BCG

Round 2

<p>Prompt</p>	<p>Our client is a start-up with the ability to deliver broadband internet to commercial airlines. How would you help them think about their offering?</p>
<p>Guidance</p>	<p><i>About the case: This is a market entry case where candidate are required to evaluate the feasibility of a new product in conjunction with the airline industry. The candidate should use a comprehensive framework, walk the interviewer through it and be prepared for analytical detours throughout the flow of the case.</i></p> <p><i>The calculations represented here are only one approach and interviewees may take other approaches, depending on the assumptions made. The interviewer should be mindful of this and allow for flexibility.</i></p> <p><i>Industry & Market Size Discussion: The interviewee should have mentioned this as a major bucket in his/her framework.</i></p> <p><i>Use the information below to provide guidance as necessary.</i></p> <p><u>Broadband for the airlines</u> <i>There is general interest in broadband internet from the airline industry. The start up would have to invest relatively little up front and would keep most of the revenues. They would charge the customers on a per flight pricing model.</i></p> <p><u>Size of the Market</u> <i>Ask the candidate to estimate the market size and hand over <u>Exhibit 1</u>. Inform the candidate that there are 3,000 planes. Full answer in chart below</i></p> <p><u>Pricing</u> <i>In order to finish the market size, the candidate should ask for the price per flight. Hand out <u>Exhibit 2</u> and ask candidate to set the price.</i></p>

Case 28: Stew's Connections

Market Entry

BCG

Round 2

Analysis	Class	First	Coach
	Seats/Plane	20	180
	Load Factor	.75	.75
	Full seats/plane	15	135
	Biz Travelers	100%	30%
	Laptop users/plane	15	40.5
	Total laptop users/plane	55.5	
	<i>3000 planes x 2000 legs/plane x ~50 laptop users/plane = 300,000,000 approximate annual potential user-legs.</i>		

Case 28: Stew's Connections

Market Entry

BCG

Round 2

<p>Analysis</p>	<p>Assume 100 passengers (for ease) at the various price/penetration combinations.</p> <p>30 users at \$5=\$150/flight</p> <p>25 users at \$10=\$250/flight</p> <p>20 users at \$15=\$300/flight</p> <p>10 users at \$20=\$200/flight</p> <p>5 users at \$25=\$125/flight</p> <p>Set price at \$15.</p>
<p>Guidance</p>	<p><i>Breakeven Analysis</i> <i>Given the information already revealed in the case and the information below the candidate should calculate a break-even point.</i></p> <p><i>Information to be given if asked:</i> <i>The company has discovered that if they can generate \$250,000 per plane in annual revenue, they will be profitable installing the technology on that plane.</i></p>
<p>Analysis</p>	<p>$250,000 / 2,000 \text{ legs/plane} = \\$125/\text{leg}$</p> <p>$\\$125 / \\15 about 8 users/leg</p> <p>50 laptop users/leg, and at \$15, there's a penetration rate of 20%, so we estimate 10 users/leg.</p> <p>Response: Yes, they should break even.</p>

Case 28: Stew's Connections

Market Entry

BCG

Round 2

<p>Guidance</p>	<p><i>Other factors</i> <i>Probe the candidate for breadth and understanding of new market entry. Ask him/her about the following aspects of this project.</i></p>
<p>Analysis</p>	<p>Competition The interviewer should probe deeper into the competition especially with regard to Intellectual Property. For this case, the company has the patent on the high speed connection. What about low-speed internet connections?</p> <p>Risks Ask the candidate which risks are associated with the business model. Use your judgment when considering their answers.</p>
<p>Performance Evaluation</p>	<p>Candidate should provide a crisp recommendation – A crisp recommendation should be roughly 30 - 45 seconds long and should include clear bullet points that support an overall recommendation. For example, “Enter the market for reasons 1, 2 and 3”</p> <p>Expected: Accurate arithmetic with solid profitability and breakeven calculations.</p> <p>Good: Candidate provides a framework that includes exploration of all possible options and offers a clear recommendation that summarizes key findings in under 30 seconds.</p> <p>Excellent: Candidate considered sufficient number of other factors while maintaining poise through “what else” line of questioning at the end of the case.</p>

Case 28: Stew's Connections

Market Entry

BCG

Round 2

Exhibit 1

Exhibit 1		Passenger mix by cabin	
		First	
Annual flights legs per plane	2000	Business	100%
Average seats per plane	200	Leisure	0%
Average load factor	75%		
Cabin seating:		Coach	
First class	10%	Business	30%
Coach	90%	Leisure	70%
Note: 90% of business travelers carry laptops; 0% of Leisure travelers carry laptops			

Case 28: Stew's Connections

Market Entry

BCG

Round 2

Exhibit 2

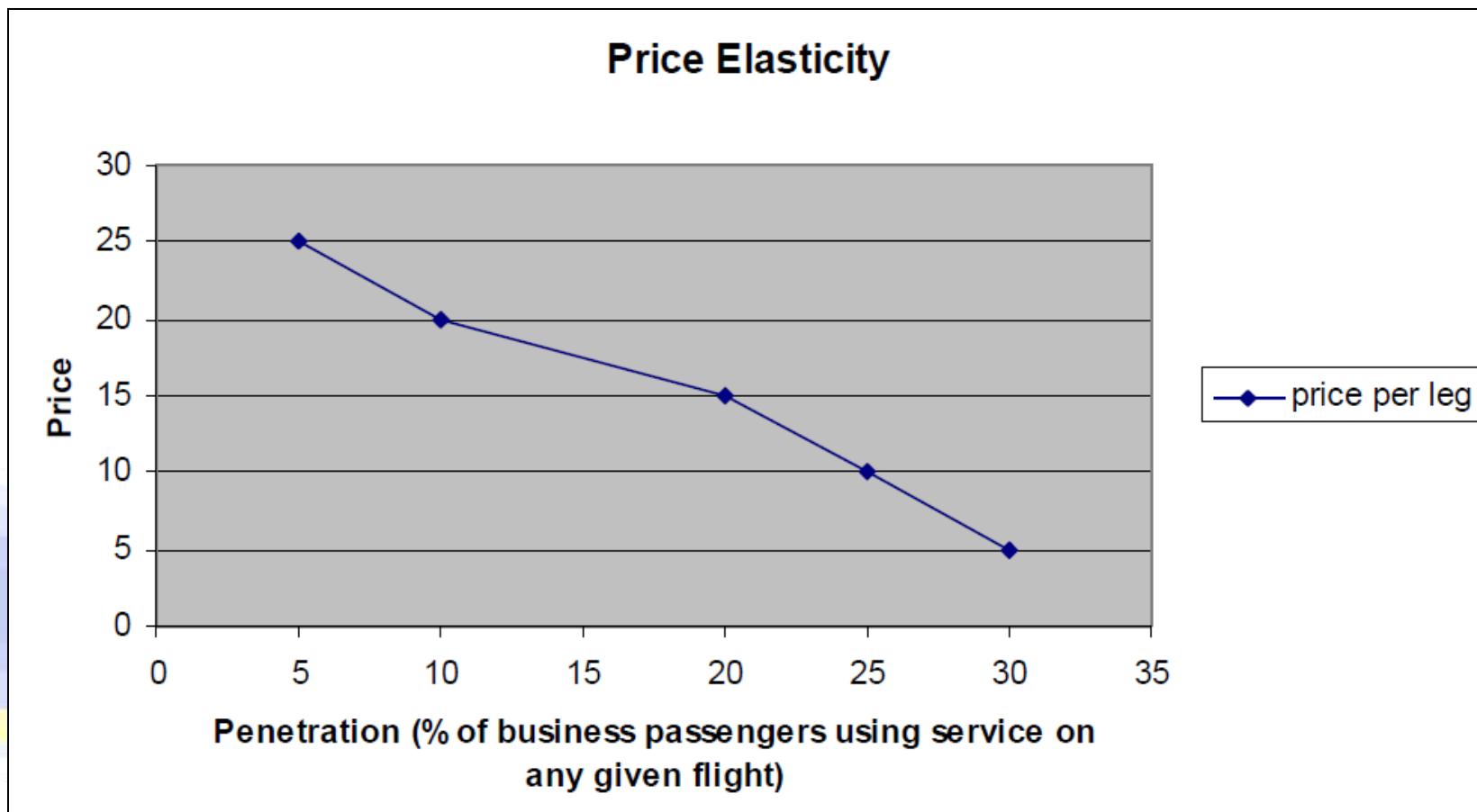

Case 29: One for the Road, Inc.

Market Entry: Life Sciences

DMCC

Round 1

<p>Prompt</p>	<p><u>Problem Definition:</u> A small life science technology startup, One For The Road, Inc., (ORI), has invested a huge amount of money in R&D and was recently granted a patent for a new breakthrough product. The client wants to know what approach it should take to commercialize the product.</p>
<p>Guidance</p>	<p><i>This is a “Go to Market” case combined with a piece on M&A. The case is structured on the 3C’s framework and combines the following two questions:</i></p> <ul style="list-style-type: none"> ▪ <i>What are the core competencies of this company?</i> ▪ <i>Do they have the funds to develop the capacity in-house, or should they be looking for a partner or buyer for the patent?</i> <p><i>This section of the case is exploratory in nature so make sure that the candidate has come up with a healthy list of questions before proceeding.</i></p> <p><i>Information to be given if asked:</i></p> <ul style="list-style-type: none"> ▪ <i>How long is the patent protection? - 10 years</i> ▪ <i>Are there any competitors? - No. This product would create a new market</i> ▪ <i>Market potential? - The client expects sizable immediate demand</i> ▪ <i>How much money has been invested in R&D? - Substantial amounts</i>
<p>Prompt— Part II</p>	<p>Market Strategy – Discuss the following aspects with the candidate:</p> <ul style="list-style-type: none"> ▪ Managing hyper growth ▪ Optimal acquisition strategy (new customers) ▪ Appropriate pricing via EVC analysis

Case 29: One for the Road, Inc.

Market Entry: Life Sciences

DMCC

Round 1

<p>Prompt— Part III</p>	<p><u>Operations Strategy</u> – Discuss the following aspects with the candidate:</p> <ul style="list-style-type: none"> ▪ Costs: fixed and variable ▪ R&D Resources/Strengths ▪ Required Capabilities: Buy, Build, or Partner? ▪ Manufacturing: in house vs. outsourcing ▪ Marketing & Sales ▪ Distribution Channels
<p>Prompt— Part IV</p>	<p><u>Finance Strategy</u> – Discuss the following aspects with the candidate:</p> <ul style="list-style-type: none"> ▪ Debt vs. Equity to finance growth ▪ Timeline to break even
<p>Prompt— Part V</p>	<p><u>External Factors</u> – Discuss the following aspects with the candidate:</p> <ul style="list-style-type: none"> ▪ Legislation ▪ Suppliers of raw materials
<p>Prompt— Part VI</p>	<p><u>M&A potential</u> – Ask the candidate to discuss various entry strategies available to the client w.r.t introducing the product in the market.</p>
<p>Analysis</p>	<p>Candidate should assert that the client has several options:</p> <ul style="list-style-type: none"> ▪ Acquire a company that provides manufacturing and marketing capabilities ▪ Joint venture with another company ▪ Outsource manufacturing, marketing and distribution channels ▪ Grow skill sets organically, ergo more slowly

Case 29: One for the Road, Inc.

Market Entry: Life Sciences

DMCC

Round 1

<p>Prompt— Part VII</p>	<p><u>Evaluating M&A options</u> – Ask the candidate to evaluate the pros and cons of the different strategies suggested above</p>												
<p>Analysis</p>	<p>Given that the client is a small R&D lab, its core competency is not in the area of manufacturing, marketing, and sales. ORI should certainly pay attention to the profitability of these strategies, but also bear in mind the risk (while going alone may allow ORI to keep all the profits, it has many more pitfalls than teaming with an established player in the industry).</p> <p>The following comparison matrix presents the pros and cons of the various strategies (do not hand this to the candidate, rather allow them to form their opinion and then guide them where necessary)</p> <table border="1" data-bbox="513 689 1599 922"> <thead> <tr> <th>Criterion</th> <th>Develop capability internally</th> <th>Get external partners</th> </tr> </thead> <tbody> <tr> <td>Speed</td> <td>Slow</td> <td>Fast</td> </tr> <tr> <td>Cost Benefits</td> <td>Expensive</td> <td>Cheap</td> </tr> <tr> <td>Growth / Future capabilities</td> <td>Fast and sustainable growth</td> <td>Slow growth</td> </tr> </tbody> </table>	Criterion	Develop capability internally	Get external partners	Speed	Slow	Fast	Cost Benefits	Expensive	Cheap	Growth / Future capabilities	Fast and sustainable growth	Slow growth
Criterion	Develop capability internally	Get external partners											
Speed	Slow	Fast											
Cost Benefits	Expensive	Cheap											
Growth / Future capabilities	Fast and sustainable growth	Slow growth											
<p>Prompt— Part VIII</p>	<p><u>Patent pricing strategy</u> – Inform the candidate that ORI has decided to sell the patent to an established pharmaceutical firm and ask him how he might derive an acceptable price for the product from the pharmaceutical company.</p>												
<p>Analysis</p>	<ul style="list-style-type: none"> ▪ Conduct Economic Value to the Customer (EVC) analysis ▪ Surveys to potential customers in order to conduct a conjoint analysis ▪ Chance to price discriminate among segments (if it can tweak product attributes) ▪ Analyze past introductions of new products for historical sales trends ▪ Focus group experiments in <i>separate, comparable regions</i> (to find price elasticity): <ul style="list-style-type: none"> ▪ Lower the price in one and raise the price in the other ▪ Compare the sales volume over a period of time 												

Case 29: One for the Road, Inc.

Market Entry: Life Sciences

DMCC

Round 1

**Prompt—
Part IX**

Consumer segmentation - Inform the candidate that the new market has two segments, healthcare providers and home users and ask him to list some differing characteristics between the two groups that might affect the client's marketing strategy.

Analysis

Again, do not hand this to the candidate, rather allow the candidate to form his/her own opinion and then guide them where necessary

Criterion	Healthcare Provider	Home User
User's preferences	Cost, Maintenance	Ease of use, reimbursable costs
Who is the Decision Maker?	Doctor / Procurement Manager	User / Parent / Spouse
Contact strategy	Trade shows, Direct marketing	Doctor(push) / TV, or print ads (pull)
Resource requirements	Experienced sales force to convince doctors or procurement manager	Convenience, ease of use

Case 29: One for the Road, Inc.

Market Entry: Life Sciences

DMCC

Round 1

<p>Performance Evaluation</p>	<p>Expected: Accurate arithmetic with solid calculations while keeping track of information/data from earlier parts of the case throughout the entire interview. This is a long case, they need to stay organized and composed.</p> <p>Good: All of the above, while also anticipating some of the prompts before the interviewer needs to suggest the next step. Really piecing this case into real life and coming up with some real life next steps.</p> <p>Excellent: Candidate considered all of the prompts throughout the case, while constantly keeping track of earlier information and referring back to the situation at hand. Never losing site of the big picture. Lastly, maintaining poise through the extensive line of questioning throughout the case.</p>
--------------------------------------	---

Case 30: DMB Satellite, Inc.

Market Entry

DMCC

Round 2

<p>Prompt</p>	<p>Stefan Lessard, the CEO of a large conglomerate, finds a once-in-a-lifetime deal and buys a satellite at a heavily discounted price. He can keep it or sell it today for a profit. What questions could you ask to gain critical information?</p>
<p>Guidance</p>	<p><i>The candidate should take some time to think and then come up with some basic questions. Candidates should recognize this case as a profitability / market extension case. The candidate should request revenue and cost information and then calculate the profit for each situation. Later, the candidate should consider market dynamics, and the risks associated with having a single customer versus a diversified portfolio.</i></p> <p><u><i>This information should be given if asked for:</i></u></p> <ul style="list-style-type: none"> - <i>Cost of satellite acquisition: \$10 million</i> - <i>Market value of satellite today: \$35 million</i> - <i>Repair/maintenance cost: Negligible. The satellite is in good condition.</i> - <i>Launch status of satellite: Satellite is still in the box and needs to be launched if the company decides to keep it. DMB can use it for 3 years after which it becomes obsolete (\$0 resale value and non-functional).</i> - <i>Costs associated with launch: Launch costs are \$10 million for high orbit launch and \$8 million for low orbit launch.</i> - <i>Low orbit satellites are used to transmit data between two points where the distance between them is on the order of 3,000 to 5,000 miles (e.g. from one coast to another). These satellites are primarily used by corporations to transmit data in batches. Low orbit signal is subject to high interference, thus it is not used when continuous transmission quality is critical. (solution for multiple clients option)</i> - <i>High orbit satellites are primarily used for continuous transmission (i.e. in real time) where signal quality is critical. Live global television broadcasting is the primary application. (solution for news, broadcasters, etc. - single client option)</i>

Case 30: DMB Satellite, Inc.

Market Entry

DMCC

Round 2

<p>Guidance</p>	<p>- Life expectancy: 5 years (needs to be replaced in 5 years, as it becomes obsolete) - Potential customers for satellite services: There are two customer segments based on use: data transmission and voice/video transmission. Large corporations use satellites to batch transfer information periodically during the day. The use is short and intermittent, allowing for multiple clients. News broadcasters and telecommunications companies use the satellites for voice/ video transmission. They require 24-hour, global coverage limiting the satellite to only one client. Potential to lease satellite capacity: Leasing satellite capacity is a good option but not available in this case</p>
<p>Prompt— Part II</p>	<p>What is the best road to profits for DMB Satellite?</p>
<p>Guidance</p>	<p>The candidate should conduct a profitability analysis listing the 3 options. 1) Sell today for a \$35M profit, 2) Operate single satellite offering data transmission service to multiple clients, and 3) Operate single satellite system to offer voice and video transmission.</p> <p><u>Low Orbit Revenues</u></p> <ul style="list-style-type: none"> ▪ Each Year 1 customer pays \$50,000 per month ▪ Each Year 2 customer pays \$30,000 per month ▪ Each Year 3 customer pays \$20,000 per month ▪ There is some competition entering the market and you can assume that you will need to reduce the prices for the multiple customer solution every year to attract incremental revenues. Prices for the contract you sign in year 1, however, fall to new rates in year 2. ▪ 80% of customers generated in a given year will remain the following year. <p>[Note: Data has been intentionally left out. The candidate should ask for the expected number of customers in each of the 3 years (see solution in Analysis section)]</p>

Case 30: DMB Satellite, Inc.

Market Entry

DMCC

Round 2

Guidance

High Orbit Revenues

The high orbit customer pays \$2,500,000 per month

This is a specialized market, where we have found only one potential customer who is ready to sign up

The candidate should continue with the profitability analysis and cash flow calculations comparing the three options: sell now, low orbit, and high orbit. If the candidate asks, the discount rate is negligible.

Analysis

Calculations:

New Customers	Months	Cost	Y1 total revenue	Y2 total revenue	Y3 total revenue	Revenue
50	12	50,000	30,000,000	4,400,000	7,680,000	52,080,000
40	12	30,000		14,400,000	1,520,000	25,920,000
30	12	20,000			7,200,000	7,200,000

Rule: lose 20% of existing customer base in following year
Total Revenue: 85,200,000
Cost: 100,000
Profit: 85,100,000

Calculations:

New Customers	Months	Cost	Y1 total revenue	Y2 total revenue	Y3 total revenue	Revenue
1	12	2,500,000	30,000,000	30,000,000	30,000,000	90,000,000

Total Revenue: 90,000,000
Launch Cost: 2,500,000

The high orbit customer pays 2.5 million monthly
Profit: 87,500,000

Case 30: DMB Satellite, Inc.

Market Entry

DMCC

Round 2

<p>Analysis</p>	<p>Summary of profitability calculations:</p> <p><u>Option #1</u> - Sell today for a \$35 million dollar pre-tax profit. Strong candidates will recognize that the \$10 million acquisition cost is a sunk cost.</p> <p><u>Option #2*</u> - Operate single satellite offering data transmission service to multiple clients: \$73,360,000 profit (pre-tax). One key trick is that in year one you'll have 50 clients, in year two those 50 clients become $50 \times 80\% = 40$ clients. In year three those 40 clients have been reduced again to $40 \times 80\% = 32$ clients.</p> <p><u>Option #3*</u> - Operate single satellite system to offer voice and video transmission. Requires increased upfront investment: \$85,000,000 profit (pre-tax).</p> <p>* Very important: Candidate should remember to verify that company has access to capital for purchase and launch.</p>
<p>Prompt— Part III</p>	<p>Carter Beauford, DMB Satellites' President, wants some answers during your morning elevator ride. What do you say?</p>
<p>Guidance</p>	<p><i>Option 3 generates the highest profits. However, Option 3 has highest initial cost and offers strong bargaining power for the single client. Also, what if we lose the client somehow to bankruptcy? There are also few available customers. The risk is high.</i></p> <p><i>Option 1 gives us a nice chunk of change. But, do we have other viable investment opportunities for the cash generated in that sale? If the market value of the satellite is \$45 million, it's doubtful we can find another for only \$10 million.</i></p> <p><i>Option 2 offers a diversified client portfolio, and seems to be the optimal choice</i></p>

Case 30: DMB Satellite, Inc.

Market Entry

DMCC

Round 2

<p>Performance Evaluation</p>	<p>Expected:</p> <ul style="list-style-type: none"> • Calm and composed despite the broad nature of the original prompt • Developed a framework that is relevant to the prompt. <p>Good:</p> <ul style="list-style-type: none"> • Developed a framework that is relevant to the prompt. • Listed the 3 options and used it to guide analysis. • Analyzed the data well on a piece by piece basis. • Final recommendation was to the point and data-driven and used facts and data to back up thoughts. • Remembered to clarify if the client has access to capital for purchase and launch <p>Excellent:</p> <ul style="list-style-type: none"> • Placed data analysis in a table format • No math errors • Considered risks and benefits of each strategy. Final recommendation was persuasive and delivered with a bottom line tone.
--------------------------------------	---