



# Built-In Gas Cooktop

## Installation Instructions

Available Models

GH12SFC/GH30SFC/GH60SSC/GH90SF



✉ [ozmyhomeappliances@gmail.com](mailto:ozmyhomeappliances@gmail.com)

🛒 [www.gaslandchef.com.au](http://www.gaslandchef.com.au)

## Warning

### General Safety

- The appliance may only be installed and connected by licensed gas fitters authorized persons.
- Built-in appliances may only be used after they have built in to suitable built-in units and work surfaces that meet local authority standards.
- Repairs to the appliance must only be carried out by trained registered authorized service persons / engineers.
- The technical and identification data for the hob is located on the reference data plate fixed to the underside of the appliance.
- This reference data plate must be consulted before making the electrical connections.
- The electrical connections must be made by specialist installers to the legal and regulatory, requirements in each country.
- If the cable is damaged in any way it must be replaced by the manufacturer or after sale service or by authorized technical staff, to avoid hazard.

DO NOT USE OR STORE FLAMMABLE MATERIALS NEAR THIS APPLIANCE.

DO NOT SPRAY AEROSOLS IN THE VICINITY OF THIS APPLIANCE WHILE IT IS IN OPERATION.

DO NOT MODIFY THIS APPLIANCE.

DO NOT USE THIS APPLIANCE AS A SPACE HEATER.

## Correct Use

People (including children) who, because of their physical, sensory or mental capabilities or their inexperience or ignorance are not able to use the device safely, should not use this device without supervision or instruction by a responsible person. This appliance should be used only for normal domestic cooking and frying of food. The appliance must not be used as a work surface or as a storage surface. Additions or modifications to the appliance are not permitted. Do not place or store flammable liquids, highly inflammable materials or fusible objects (e.g. plastic film, plastic, aluminum) on or near the appliance. Do not heat an empty pan on the appliance.

## Children's Safety

- The cooking zones will become hot when you cook. Therefore, always keep small children away from the appliance.

Australia:

✉ [ozmyhomeappliances@gmail.com](mailto:ozmyhomeappliances@gmail.com)

🌐 [www.gaslandchef.com.au](http://www.gaslandchef.com.au)

**GO SLAND**  
chef



United States:

☎ 1(844) 538-7890

🌐 [www.gaslandchef.com](http://www.gaslandchef.com)



- The appliance is not intended for use by young children or infirm persons without supervision.
- Young children should be supervised to ensure that they do not play with the appliance.

## Safety During Use

- There is the risk of burns from the appliance if used carelessly.
  - Cables from electrical appliances must not touch the hot surface of the appliance or hot cookware.
  - Overheated fats and oils can ignite very quickly. Warning! Fire hazard!
  - Switch the cooking zones off after each use.
  - Users with implanted pacemakers should keep their upper body at least 30 cm from cooking zones that are switched on.
  - Risk of burns! Do not place objects made of metal, such as knives, forks, spoons and saucepan lids on the cooking surface, as they can get hot.
  - Special conditions, which shall be avoided, e.g. marine environment, and any conditions necessary to ensure optimum performance.
  - The appliances can be used in freezing conditions.
  - Appliance not suitable for aftermarket lids or covers.
- symbols marked on the glass hotplates:



	Do not place anything, e.g. flame tamer, asbestos mat, between pan and pan support as serious damage to the appliance may result
	Do not remove the pan support and enclose the burner with a wok stand as this will concentrate and deflect heat onto the hotplate
	Locate pan centrally over the burner so that it is stable and does not overhang the appliance
	Do not use large pots or heavy weights which can bend the pan support or deflect flame onto the hotplate
	Use only a wok support supplied or recommended by the manufacturer of the appliance

## Warning! Fire Hazard!

- Switch the cooking zones off after each use.
- Users with implanted pacemakers should keep their upper body at least 30cm from cooking zones that are switched on.

Australia:

✉ [ozmyhomeappliances@gmail.com](mailto:ozmyhomeappliances@gmail.com)

🌐 [www.gaslandchef.com.au](http://www.gaslandchef.com.au)

**GASLAND**  
chef



United States:

☎ 1(844) 538-7890

🌐 [www.gaslandchef.com](http://www.gaslandchef.com)



- Risk of burns! Do not place objects made of metal, such as knives, forks, spoons and saucepan lids on the cooking surface, as they can get hot.

## Safety Instructions

### Safety When Installation

- DO NOT USE OR STORE FLAMMABLE MATERIALS NEAR THIS APPLIANCE.
- DO NOT SPRAY AEROSOLS IN THE VICINITY OF THIS APPLIANCE WHILE IT IS IN OPERATION.
- WHERE THIS APPLIANCE IS INSTALLED IN MARINE CRAFT OR CARAVANS. IT SHALL NOT BE USED AS A SPACE HEATER.
- This hotplate must be installed in accordance with:

AS 5601 - Gas Installations (for Australia) – current edition NZS 5261 – Code of Practice for the Installation of Gas Burning Appliances and Equipment (for New Zealand) This standard may not be now current! Local gas fitting regulations AS/NZS 3000 – Electrical Installations (Wiring Rules) Building codes Any other relevant statutory regulations.

- Check the gas type label on the underside of the hotplate, adjacent to the gas connection to ensure it corresponds to the installation gas supply. If in doubt contact the supply authority.
- The power supply cord (supplied) must not touch against any hot surfaces and must be placed so that its temperature does not exceed 75 degrees at any point along its length.
- After connecting to gas, check for leaks using soapy solution, never a naked flame.
- Where a flexible hose assembly is used, ensure it is approved to AS/NZS 1869, Class B 10mm diameter and no more than 1.0metre in length. Any hose assembly used must be restrained from accidental contact with the flue outlet of an under bench oven.

### How To Avoid Damage To The Appliance

- Do not use the cooking zones with empty cookware or without cookware.
- The ventilation gap of 5mm between the worktop and front of the unit underneath it must not be covered.
- DO NOT MODIFY THIS APPLIANCE.

Australia:

✉ [ozmyhomeappliances@gmail.com](mailto:ozmyhomeappliances@gmail.com)

🌐 [www.gaslandchef.com.au](http://www.gaslandchef.com.au)

**Gasland**  
chef

United States:

☎ 1(844) 538-7890

🌐 [www.gaslandchef.com](http://www.gaslandchef.com)



## Safety When Cleaning

- For cleaning, the appliance must be switched off and cooled down.
- For safety reasons, the cleaning of the appliance with steam jet or high pressure cleaning equipment is not permitted.

## Disposing Of The Device



When disposing of the device, do not bring it to regular municipal waste containers. Instead, bring it to electrical and electronic waste recycling and reuse center. A relevant label has been put on the device, its instructions manual, or the package. The device has been manufactured of recyclable material. By bringing old device to recycling

collection center, you show that you care about nature. Ask your local environmental care authority for information on location of such

Gas type label nearby the gas inlet, black color for natural gas, signal red color for ULPG.

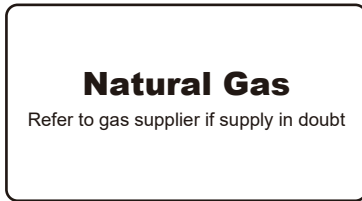

## Product Description

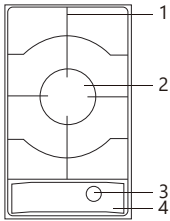

GH12SFC

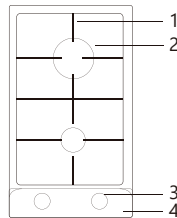

GH30SFC

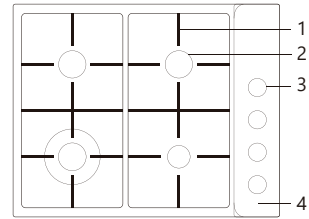

GH60SSC

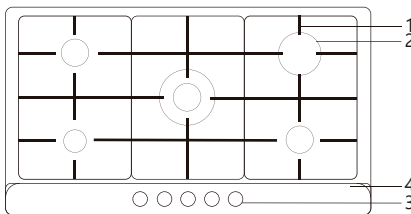

GH90SF

- 1.Pan support
- 2.Burner
- 3.Knobs
- 4.Panel

Australia:

✉ ozmyhomeappliances@gmail.com

🌐 www.gaslandchef.com.au

**GASLAND**  
chef



United States:





☎ 1(844) 538-7890

🌐 www.gaslandchef.com



Model	Burner	FSD	Pan supports	Knob position	Total gas consumption
GH12SFC	1W	With	Cast Iron	Front	NG: 13MJ/h LPG:13MJ/h
GH30SFC	1R+1SR	With	Cast Iron	Front	NG: 16.0MJ/h LPG: 16.1MJ/h
GH60SSC	1W+2SR+1A	With	Cast Iron	Right	LPG: 30.5MJ/h NG: 29.5MJ/h
GH90SF	1W+2SR+1R+1A	With	Cast Iron	Right	LPG: 39.6MJ/h NG: 39.0MJ/h

For burner: W=triple ring wok burner, R=rapid burner, SR=semi-rapid burner, A=auxiliary burner

Accessory Name	Picture ( for reference only, physical unit maybe different)	Quantity
User Manual		1
Sealing tape		1 roll
Additional labels	You have additional rating label in accessory bag, suggest attach it onto a surface where it can be read e.g. inside surface of adjacent cupboard.	1 set
Installation clip		4 sets
Screws		4 pcs
LPG Injectors		GH12SFC=1pcs GH30SFC=2pcs GH60SSC=4pcs GH60SSE=4pcs GH90SF=5pcs
Elbow & Washers		1 Elbow, 2 washers
Natural gas regulator		1

Australia:

 ozmyhomeappliances@gmail.com

 www.gaslandchef.com.au





United States:

 1(844) 538-7890

 www.gaslandchef.com



## Technical Specifications

Model	Product Dimensions (h x w x d)mm	Cut-out Size (w x d)mm	Net weight	Electrical Connection	Rated Input Power
GH12SFC	100x290x500	266 x 478	5.64Kg	220-240V/50Hz	0.5W
GH30SFC	100x290x500	266 x 478	5.32Kg	220-240V/50Hz	0.5W
GH60SSC	100 x 580 x 500	552 x 470	8.99Kg	220-240V/50Hz	0.5W
GH90SF	100 x 860 x 500	827 x 470	11.37Kg	220-240V/50Hz	0.5W

## Installation Before Installation

- Before cutting into any bench tops, ensure the minimum clearances to walls, adjacent surfaces and overhead surfaces required by the relevant gas appliance installation code (see above) will comply. Dimensions are specified in millimeters (mm)

Overhead cupboards and range hood = 650 mm.

Side and rear clearance = 200 mm to any burner edge.

Overhead exhaust/ceiling fan = 750 mm

Horizontal surfaces adjacent the hob = less than or equal to the hob height.

Ensure there is sufficient clearance to fit the regulator and/or flexible hose connection with the hotplate in the installed position.

Before the appliance is installed into the cabinet, please make sure any transit protection is removed.

### When you have installed the hob, make sure that

- The GPO(general purpose outlet) must always be in an accessible position.
- The supply connection point, test point and natural gas regulator adjustment screw (for Natural gas installation) are accessible for testing and/or adjustment with the hotplate in the installed position.

Australia:

✉ ozmyhomeappliances@gmail.com

🌐 www.gaslandchef.com.au

GASLAND  
chef



United States:

☎ 1(844) 538-7890

🌐 www.gaslandchef.com



# To Be Installed Only By An Authorized Person

## 1. Cupboard Cutting

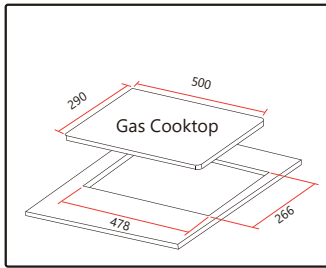

GH12SFC/GH30SFC

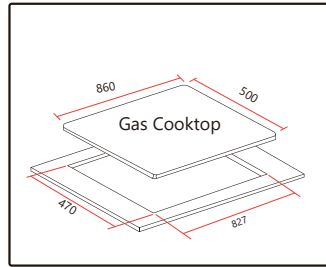

GH90SF

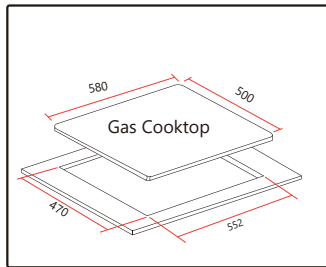

GH60SSC

## 2. Place Burner Box

Apply the adhesive sealing tape to the underside lip of the burner box. Shown at G opposite. Place burner box into cutout hole and fit clamping brackets to clamp the hotplate to the bench.

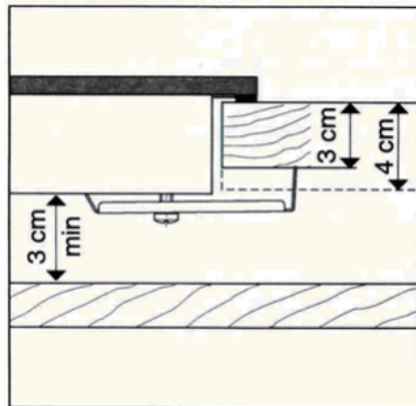
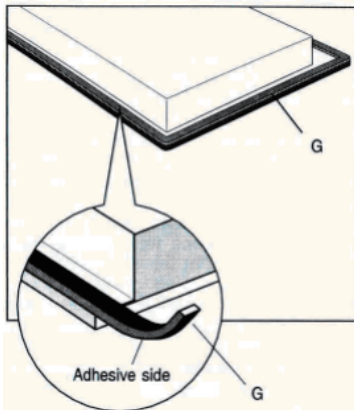

Australia:

✉ [ozmyhomeappliances@gmail.com](mailto:ozmyhomeappliances@gmail.com)

🌐 [www.gaslandchef.com.au](http://www.gaslandchef.com.au)

**OSLAND**  
 chef



United States:

☎ 1(844) 538-7890

🌐 [www.gaslandchef.com](http://www.gaslandchef.com)





### 3. Fit Burners And Trivet

Replace burners and ensure they are correctly repositioned over the ignitor and thermocouple. The ignitor must be clean for trouble free sparking. Test burner ignition and burner flame for correct operation, If burner is placed correctly it will not rotate on its supports .

The Triple Ring (Wok) burner (diagrams below) does not fit over the ignitor or thermocouple but must be placed on its supports. Make sure trivet is fitted onto its locator on burners and can't rotate after assembled.

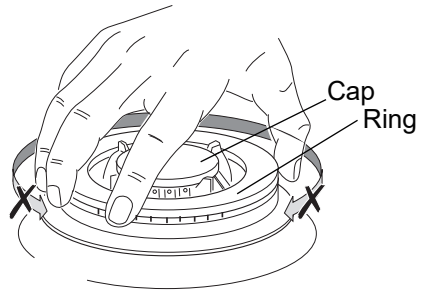
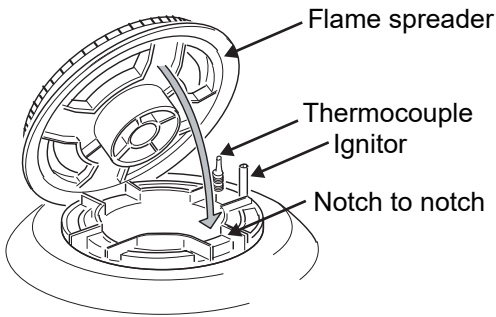
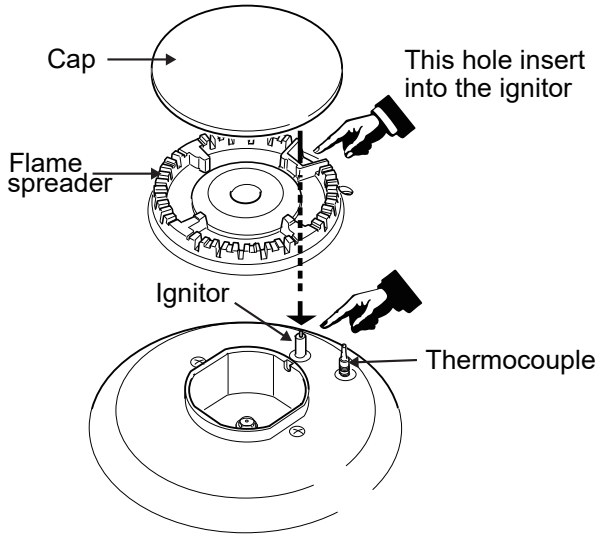

Australia:

✉ [ozmyhomeappliances@gmail.com](mailto:ozmyhomeappliances@gmail.com)

🌐 [www.gaslandchef.com.au](http://www.gaslandchef.com.au)

**GASLAND**  
chef



United States:

☎ 1(844) 538-7890

🌐 [www.gaslandchef.com](http://www.gaslandchef.com)



#### 4. Electrical Connection

Install a 10 amp general purpose outlet (GPO) in accordance with relevant electrical standards and/or codes of practice applicable.

The power supply cord (supplied) must not touch against any hot surfaces and must be placed so that its temperature does not exceed 75 °C at any point along its length.

After having installed the hotplate, the GPO must always be in an accessible position.

#### Wiring diagram

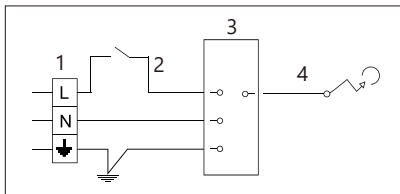

GH12SFC

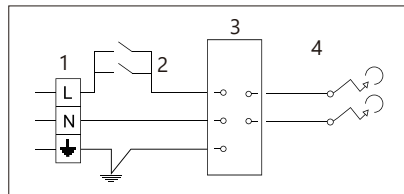

GH30SFC

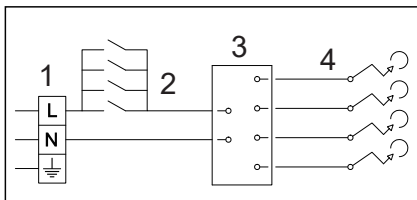

GH60SSC

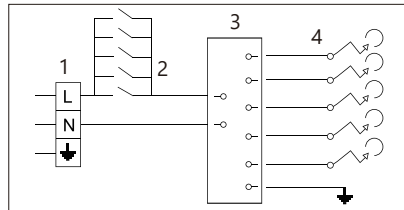

GH90SF

#### 5. Gas Connection

Install in accordance with relevant gas standards and/or codes of practice applicable.

Connect the elbow fitting to the appliance gas manifold connection, and check that seals between the elbow and manifold connection are in place and in good condition.

- For Natural gas: connect the natural gas appliance regulator (pictured opposite) with integral test point using approved gas thread tape or compound to the elbow fitting.
- For Universal LPG: see page 11

Australia:

✉ ozmyhomeappliances@gmail.com

🌐 www.gaslandchef.com.au

**GOSLAND**  
chef



United States:

☎ 1(844) 538-7890

🌐 www.gaslandchef.com



Ensure the supply connection point, test point and natural gas regulator adjustment screw (for Natural gas installation) are accessible for testing and/or adjustment with the hotplate in the installed position.



Where a flexible hose assembly is used, ensure it is approved to AS/NZS 1869, Class B. Any hose assembly used must be restrained from accidental contact with the flue outlet of an under bench oven. This hose assembly shall be suitable for connection to a fixed consumer piping outlet located as follows: Hotplates at a point 800 mm to 850 mm above the floor and in the region outside the width of the appliance to a distance of 250 mm.

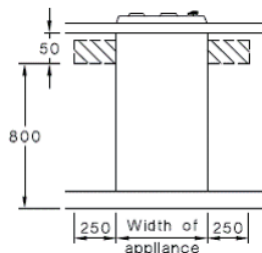

 Inlet connection region for flexible hose

After connecting to gas, check for leaks using soapy solution, never a naked flame.

Fit the duplicate data plate (supplied in separate bag) on a surface adjacent to the hotplate, for example, the inside of the cupboard door so it is clearly visible for any service technician.

#### SETTING THE GAS PRESSURE: see page 11

Fit a manometer with a 7 mm rubber hose to the test point on the regulator (for natural gas)

#### TEST FOR CORRECT OPERATION:

After installation and adjusting burner pressure using test point, each burner ignition and operation must be tested individually and with all burners operating. This testing must be done by the installer before leaving.

## Natural Gas (the appliance test point is located at the regulator)

The supplied regulator must be fitted to the appliance inlet connection. Gas pressure must be adjusted to 1.0 kPa when approximately 50% of the burners are on high flame.

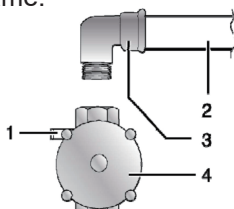

1. Test point location
2. Gas inlet pipe
3. Elbow
4. Regulator

Australia:

 [ozmyhomeappliances@gmail.com](mailto:ozmyhomeappliances@gmail.com)

 [www.gaslandchef.com.au](http://www.gaslandchef.com.au)

**GASLAND**  
chef



United States:

 1(844) 538-7890

 [www.gaslandchef.com](http://www.gaslandchef.com)



## Universal LPG (the appliance test point is located at the injector)

Gas pressure must be checked to confirm the appliance operating pressure is 2.75 kPa, the appliance test point is the rapid burner injector as shown below.

1. Disconnect power.
2. Light the auxiliary burner and set to high flame. Ensure all other burners are off.
3. Zero manometer, then apply flexible tubing to seal over the Rapid burner injector, hold securely in place and check the gas pressure by pressing in the corresponding burner control knob in, then turning to high flame position.
4. If the pressure is 2.75 kPa, reassemble the burner and perform the final checks as per this instruction manual.
5. If the pressure is not 2.75 kPa, disconnect the appliance and check, adjust or replace the LPG cylinder regulator(s) as appropriate in accordance with AS/NZS 5601.

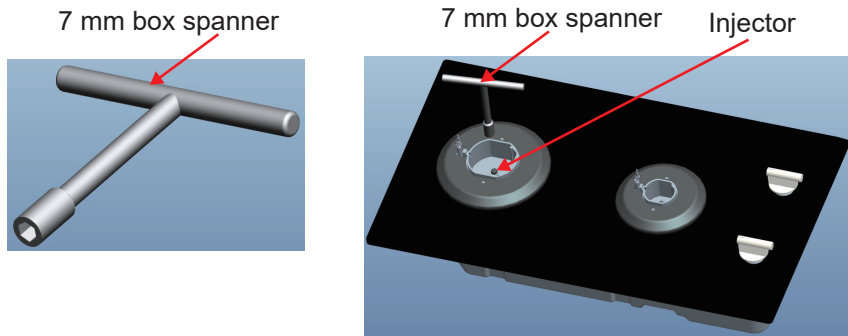

Alternative: If the appliance is supplied with an LPG test point adapter; then this component may be fitted to the inlet connection for the purpose of a test point.

### ADJUSTING THE BURNER MINIMUM FLAME HEIGHT:

**NOTE:** This adjustment can only be performed by the installer or an authorised service personnel.

The minimum burner flame is factory adjusted for the gas type stated on the gas type label adjacent to the gas connection and should not require adjustment. Adjustment may be required if the hotplate has been converted from Natural gas to Universal LPG or vice versa.

### GAS CONVERSION INSTRUCTIONS:

The manufacturers servicing instructions detail how authorised personnel may convert the hotplate from Natural gas to Universal LPG or from Universal LPG to Natural gas. Contact the manufacturer or agent as required.

Australia:

✉ [ozmyhomeappliances@gmail.com](mailto:ozmyhomeappliances@gmail.com)

🌐 [www.gaslandchef.com.au](http://www.gaslandchef.com.au)



United States:

☎ 1(844) 538-7890

🌐 [www.gaslandchef.com](http://www.gaslandchef.com)



Adjusted For Natural Gas 1.0KPa			Adjusted For Ulpg 2.75KPa		
Burner type	Nozzles Diameter (mm)	Gas consumption MJ/h	Burner type	Nozzles Diameter (mm)	Gas consumption MJ/h
Wok	1.70	13.0	Wok	0.98	13.0
Rapid	1.40	10.0	Rapid	0.90	10.0
Semi Rapid	1.10	6.0	Semi Rapid	0.70	6.1
Auxiliary	0.90	4.0	Auxiliary	0.55	4.0
Replacement of the nozzles must be performed by a qualified person. Once the nozzles have been replaced this label must to be affixed to the name plate of the appliances.			Replacement of the nozzles must be performed by a qualified person. Once the nozzles have been replaced this label must to be affixed to the name plate of the appliances.		
Natural Gas regulator is to be fitted and adjusted.			Change the NG regulator to LPG by a qualified person.		

For model GH60SSC

For model GH60SSC

Adjusted for natural gas 1.0KPa			Adjusted for ULPG 2.75KPa		
Burner type	Nozzles Diameter (mm)	Gas consumption MJ/h	Burner type	Nozzles Diameter (mm)	Gas consumption MJ/h
Wok	1.70	13.0	Wok	0.98	13.0
Rapid	1.40	9.5	Rapid	0.90	10.0
Semi rapid	1.10	6.0	Semi rapid	0.70	6.75
Auxiliary	0.90	4.5	Auxiliary	0.55	4.0
Replacement of the nozzles must be performed by a qualified person. Once the nozzles have been replaced this label must to be affixed to the name plate of the appliances.			Replacement of the nozzles must be performed by a qualified person. Once the nozzles have been replaced this label must to be affixed to the name plate of the appliances.		
Natural Gas regulator is to be fitted and adjusted.			Change the NG regulator to LPG by a qualified person.		

Australia:

✉ ozmyhomeappliances@gmail.com

🌐 www.gaslandchef.com.au



United States:

☎ 1(844) 538-7890

🌐 www.gaslandchef.com



## For model GH90SF

Adjusted for natural gas 1.0KPa		
Burner type	Nozzles Diameter (mm)	Gas consumption MJ/h
Wok	1.70	13.0
Rapid	1.40	10.0
Semi rapid	1.10	6.0
Auxiliary	0.90	4.0
Replacement of the nozzles must be performed by a qualified person. Once the nozzles have been replaced this label must to be affixed to the name plate of the appliances.		
Natural Gas regulator is to be fitted and adjusted.		

## For model GH90SF

Adjusted for ULPG 2.75KPa		
Burner type	Nozzles Diameter (mm)	Gas consumption MJ/h
Wok	0.98	13.0
Rapid	0.90	10.0
Semi rapid	0.70	6.3
Auxiliary	0.55	4.0
Replacement of the nozzles must be performed by a qualified person. Once the nozzles have been replaced this label must to be affixed to the name plate of the appliances.		
Change the NG regulator to LPG by a qualified person.		

Australia:

 [ozmyhomeappliances@gmail.com](mailto:ozmyhomeappliances@gmail.com)
 [www.gaslandchef.com.au](http://www.gaslandchef.com.au)

**GASLAND**  
chef



United States:

 1(844) 538-7890

 [www.gaslandchef.com](http://www.gaslandchef.com)

## Start Using Your Appliance

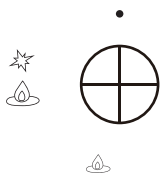
GH12SFC



GH30SFC

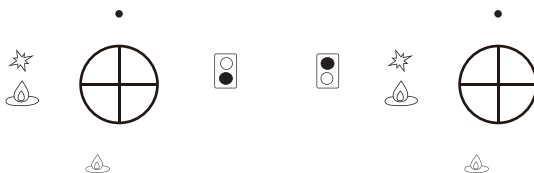

GH60SSC

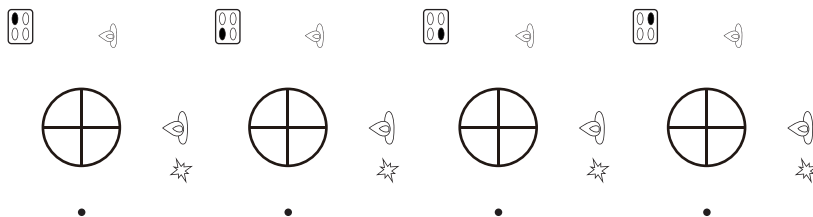

GH90SF



Description	Explanation
Zone indicators	These show which zone is under control.
Flame power	Flame power of the zones,  is the lowest and  is the highest.

Australia:

ozmyhomeappliances@gmail.com

www.gaslandchef.com.au



United States:

1(844) 538-7890

www.gaslandchef.com



The cooktop are fitted with mains powered electronic spark ignitors, so must be connected to mains power supply (i.e. nominal 220~240 V ac) to operate. If power is not available, the cooktop will still work but the burners will have to be lit with a match or similar.

Depressing the gas control knob of any burner will activate the spark ignition for all burners. To light the burner, turn the gas control knob to the High Flame setting of the burner to be lit, while at the same time depressing the gas control knob to activate the spark ignition.

Once the burner is alight continue to depress the gas control knob for 5 – 10 seconds to allow the flame safeguard to activate. If when you release the gas control knob, the burner flame goes out the flame safeguard has not heated up enough so repeat the ignition procedure after waiting 1 minute for gas to disperse. If problems with burner lighting persist, refer to the TROUBLESHOOTING section of these instructions.

If power is not available, light a match or similar, then turn the gas control knob for the burner to be lit, to the High Flame setting. Once again if problems with burner lighting persist, refer to the TROUBLESHOOTING section of these instructions.

When burner lights, adjust desired flame height. On finishing, turn control knob to off position marked with a black DOT.

## Burner And Utensil Choice

The maximum utensil (pan) diameters in millimeters (mm) for each burner are:

1. For Natural Gas cooktop
  - Auxiliary (small) and Semi-Rapid (medium) = 195 mm
  - Rapid (large) = 230 mm
  - Triple ring (wok) = 270 mm
2. For Universal LPG cooktop
  - Auxiliary (small), Semi-Rapid (medium) and Rapid (large) = 195 mm
  - Triple ring (wok) = 230 mm

Australia:

✉ [ozmyhomeappliances@gmail.com](mailto:ozmyhomeappliances@gmail.com)

🌐 [www.gaslandchef.com.au](http://www.gaslandchef.com.au)

GASLAND  
chef



United States:

☎ 1(844) 538-7890

🌐 [www.gaslandchef.com](http://www.gaslandchef.com)





The minimum utensil (pan) diameters in millimeters (mm) for each burner are:  
 Auxiliary (small) = 80 mm  
 Semi-Rapid (medium) = 140 mm  
 Rapid (large) and Triple ring (wok) = 195 mm

For best efficiency and to ensure utensil handle does not overheat, place the utensil centrally on the burner and adjust the flame height so all the flame remains under the utensil.

## Maintenance

Cleaning and maintenance should be carried out with the appliance cold especially when cleaning the enameled parts. Avoid leaving alkaline or acid substances (lemon juice, vinegar etc.) on the surfaces.

### STAINLESS STEEL

The stainless steel panel of the cooktop must be cleaned regularly (e.g. weekly) to ensure long life expectancy.

The panel has cooled. Wash down with warm soapy water and rinse with clean water.

Dry with a clean soft cloth. A specialized stainless steel cleaning fluid may be used.

**NOTE:** Ensure that wiping is done along with the grain of the stainless steel to prevent any unsightly crisscross scratching patterns from appearing.

### TRIVETS (UTENSIL SUPPORTS)

Enameled parts must only be washed with a sponge and soapy water or with non-abrasive products. Rinse with clean water. Dry with a clean soft cloth.

### BURNERS

Remove trivets from cooktop. Ensure burners are cool. Remove the burners enameled cap (C) and aluminum burner crown (F).

Note: S: Ignition pin, T: Thermocouple

Wash down with warm soapy water and rinse with clean water. Dry with a clean soft cloth.

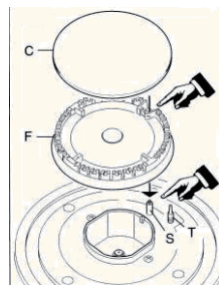

Australia:

✉ ozmyhomeappliances@gmail.com

🌐 www.gaslandchef.com.au

**GasLAND**  
 chef



United States:

☎ 1(844) 538-7890

🌐 www.gaslandchef.com



Use a cotton bud, tooth brush, or some other item to clean out any incrustations or dirt from the four holes marked(H) The spark gas is 4-6mm. Replace burners and ensure they are correctly repositioned over the ignitor (S) and thermocouple (T). The ignitor (S) must be clean for trouble free sparking. Test burner ignition and burner flame for correct operation.

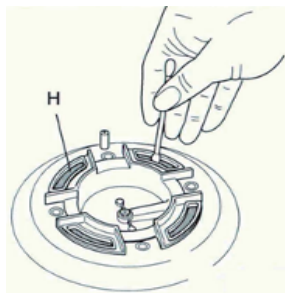

The Triple Ring (Wok) burner (diagrams below) does not fit over the ignitor or thermocouple but must be placed on its supports. If burner is placed correctly it will not rotate on its supports. The surface of cooktop, Ignition Pin(S), Thermocouple (T) and burners need to be cleaned after each time they are used with warm soapy water, rinsed and then dried well to keep them in good condition.

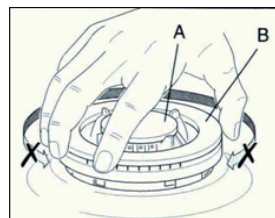

Never clean when the top and components are still warm. Do not use metal or abrasive pads, abrasive powders or corrosive spray products. Never leave vinegar, coffee, milk, salty water, lemon or tomato juice for any length of time on the surfaces.

- To replace gas and electrical components, that are lodged inside the cooktop, it is enough to remove the work top unscrewing the fixing screws of the burners.
- Replace the seal each time you change a tap in order to guarantee a perfect tightness between body and rail.

## Trouble shooting

Servicing of the cooktop must only be done by an authorised service representative and the cooktop must not be modified. Power must be disconnected before any servicing or maintenance is conducted.

**DO NOT MODIFY THIS APPLIANCE.**

It is recommended the cooktop serviced by an authorized person at least every 2 years. This service is not covered by warranty.

Abnormal conditions include:

- Excessively yellow or sooting flame type.
- Flame lifting off the burner ports.

Australia:

✉ [ozmyhomeappliances@gmail.com](mailto:ozmyhomeappliances@gmail.com)

🌐 [www.gaslandchef.com.au](http://www.gaslandchef.com.au)

GASLAND  
chef



United States:

☎ 1(844) 538-7890

🌐 [www.gaslandchef.com](http://www.gaslandchef.com)



- Flame lighting back into the burner (normally associated with a popping sound).
- Objectionable odour of the flames combustion products.

Should a faulty condition develop in the cooktop that is not described above, refer to the following table first for possible causes and remedies prior to contacting an authorised service representative. Servicing beyond the remedies listed shall only be undertaken by an authorised service representative.

## Trouble Shooting Table

Problem	Possible Causes	What To Do
No spark when gas control knob depressed.	No power.	Check plugged in and switched on. Check mains circuit breaker.
	Loose sparker cable.	Check the spark cable if loose.
	Burner not aligned properly.	Remove and re-fit burner.
Burner not lighting when spark ignition working.	Gas supply off.	Check gas supply valve on.
	Gas regulator installation direction faulty.	Reverse the direction to reinstall.
	Installed a high pressure gas regulator.	Replace a correct pressure gas regulator
	Burner not aligned properly. Burner ports blocked.	Remove and re-fit burner.
Burner goes out when control knob released.	Flame safeguard not activated.	Re-light, allow more time for flame safeguard to activate.
	Flame safeguard faulty connection or broken.	Check the thermocouple cable connection if loosen or broken.
Uneven flame pattern or slight flame lifting.	Burner ports blocked or burner dislocation.	Remove, clean and replace burner. Reassemble the burner.
At minimum flame setting the flame is too high.	Turn down control setting incorrect.	Adjust the minimum screw.

Australia:

 [ozmyhomeappliances@gmail.com](mailto:ozmyhomeappliances@gmail.com)

 [www.gaslandchef.com.au](http://www.gaslandchef.com.au)



United States:

 1(844) 538-7890

 [www.gaslandchef.com](http://www.gaslandchef.com)



Small flame on high setting.	Regulator faulty.	Choose a correct regulator.
	Gas supply pressure low.	Check the gas supply if run out.
	Incorrect injector fitted.	Check the injector if correct.
	Blocked injector or gas supply tube.	Check the the injector and gassupply tube if blocked.
Flame too high on highsetting.	Incorrect utensil size.	Choose a suitable utensil.
	Regulator faulty(Gas pressure is too high).	Choose a correct specification gas regulator(out let pressure)
	Incorrect injector fitted.	Check injector if correct and replace it.
Flame tips are very yellow	Incorrect utensil size.	Choose a suitable utensil.
	Incorrect gas supply type or incorrect gas regulator.	Check the gas supply type andgas regulator if correct.

## For model

GH12SFC/GH30SFC



GH60SSC/GH90SF



Australia:

✉ ozmyhomeappliances@gmail.com

🌐 www.gaslandchef.com.au

**GASLAND**  
chef



United States:

☎ 1(844) 538-7890

🌐 www.gaslandchef.com





# GASLAND chef



Scan me  
f @ t v

1 (844) 538-7890

 [www.gaslandchef.com](http://www.gaslandchef.com)

