



# GAS WATER HEATER

BE SERIES PORTABLE TANKLESS

## Installation Instructions

Available Colours



 02-8764-8621

 [www.gaslandchef.com.au](http://www.gaslandchef.com.au)

 [ozmyhomeappliances@gmail.com](mailto:ozmyhomeappliances@gmail.com)

# Contents

1-2	Safety Precautions
3-6	Use Precautions
7-8	Product Features & Appearance
8-10	Safety Features
11-13	How To Use The Connectors
14-22	Troubleshooting
22	Major Components
23-24	Technical Parameter
24-26	In The Box
27-28	Warranty



# Congratulations

You've just purchased a new Gasland BE series portable gas water heater. This will open a world of enjoyment to going tankless. We highly suggest you take the time to read through all of the safety and installation procedures in this manual, before attempting to install your new water heater. Should you have any questions, please feel free to contact us via email at [ozmyhomeappliances@gmail.com](mailto:ozmyhomeappliances@gmail.com) for further information.

## Safety Precautions



### Caution

- This appliance is for outdoor use only. This appliance can produce carbon monoxide which has no odor. Using it in an enclosed space will cause death. Do not use in caravans, tents, marine craft, cars, mobile homes or similar locations.
- This appliance is not intended for the supply of drinking water. This appliance is intended for the supply of heated water, for the purpose of showering, washing and cleaning only.
- Always cover the appliance when not in use, and this appliance could not be exposed to strong wind or rain.



### Warning

- Use two shifting spanners when connecting the gas regulator hose to the appliance or damage to the gas valve may occur.
- Check and confirm safe water temperature before using this appliance water from this appliance may be very hot.
- If the outside temperature is near or below freezing 0°C ensure that the system is properly drained. See instructions inside.



Australia:

[ozmyhomeappliances@gmail.com](mailto:ozmyhomeappliances@gmail.com)

[www.gaslandchef.com.au](http://www.gaslandchef.com.au)

**GASLAND**



United States:

[1\(844\) 538-7890](tel:1(844)538-7890)

[www.gaslandchef.com](http://www.gaslandchef.com)





## Danger

Install and properly vent the appliance. Failure to properly install the appliance in this manual can result in unsafe operation of the appliance. To avoid the risk of fire, explosion, or asphyxiation from carbon monoxide, never operate this appliance unless it is installed properly and has an adequate air supply for proper operation. Be sure to inspect the flue terminal for proper installation at initial start-up, and at least annually thereafter.

## Safety Instructions

This appliance shall only be used in an open-air situation with natural ventilation, without stagnant areas, where gas leakage and products of combustion can rapidly dispersed by wind and natural convection.

The following figures are show suitable outdoor areas for use with this appliance. Rectangular areas have been use in these figures, the same principles apply to any other shaped areas.

1) An area with walls on all sides but without overhead cover:

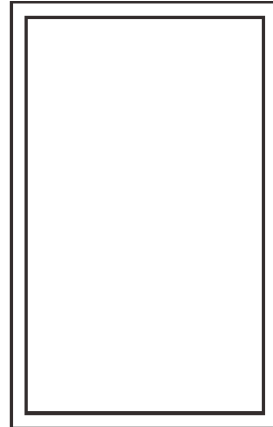
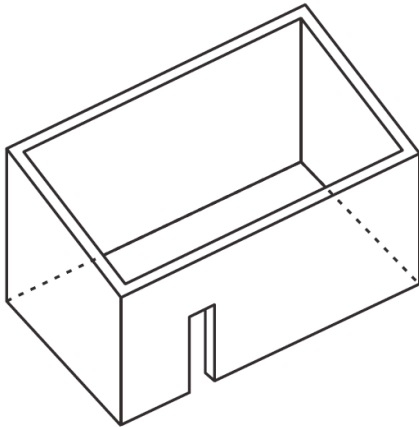

Australia:

 [ozmyhomeappliances@gmail.com](mailto:ozmyhomeappliances@gmail.com)

 [www.gaslandchef.com.au](http://www.gaslandchef.com.au)

**GASLAND**



United States:

 1(844) 538-7890

 [www.gaslandchef.com](http://www.gaslandchef.com)



2) With a partial enclosure and include an overhead cover and no more than two walls.

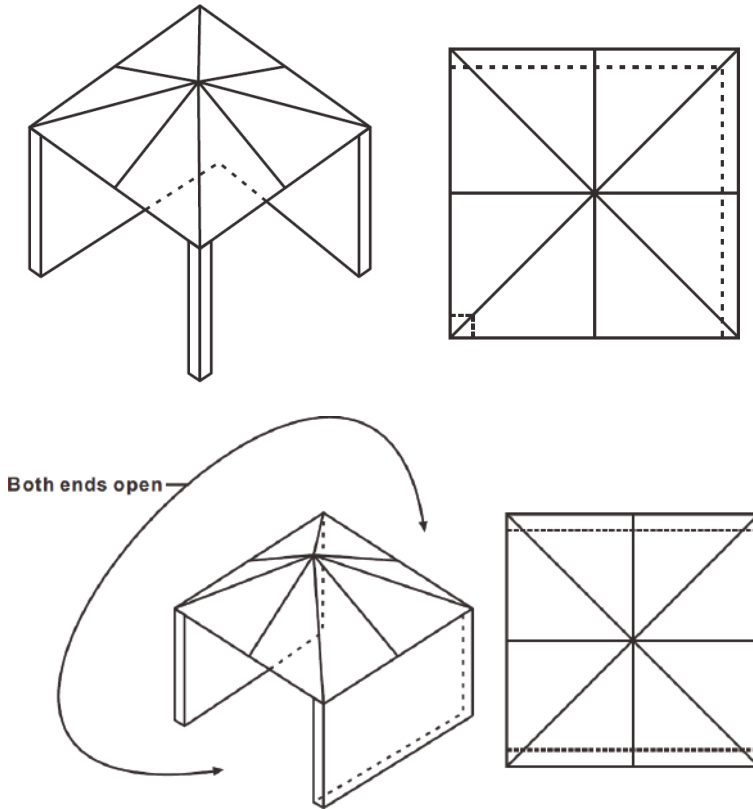

3) With a partial enclosure and include an overhead cover and more than two walls, the following shall need to fulfilled:

- A) At least 25% of the total wall area is completely open.
- B) 30% or more in total of the remaining wall side, back and front wall areas is open and unrestricted.
- C) In the case of balconies, 20% or more of the total wall area shall remain open and unrestricted.

Australia:

✉ ozmyhomeappliances@gmail.com

🌐 www.gaslandchef.com.au

**GASLAND**



United States:

☎ 1(844) 538-7890

🌐 www.gaslandchef.com



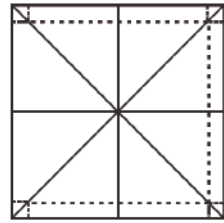
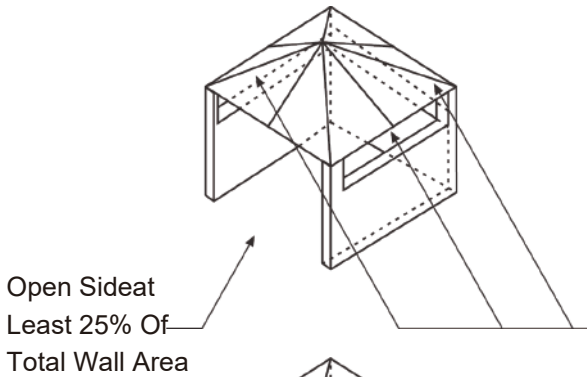

30 Percent Or More In Total  
Of The Remaining Wall Area  
Is Open And Unrestricted

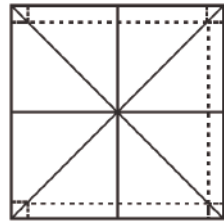
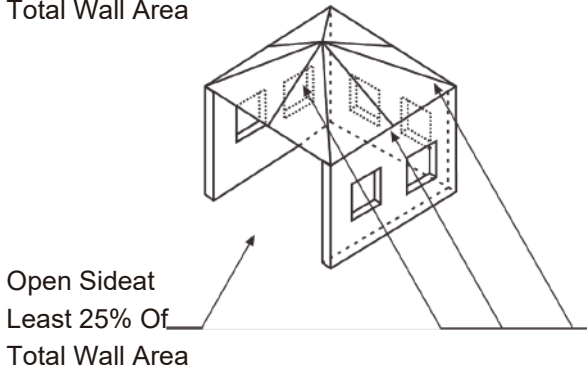

30 Percent Or More In Total  
Of The Remaining Wall Area  
Is Open And Unrestricted

## Symbols Explanation

According to the danger and damage to distinguish different warning notice:



Caution

Neglect this notice and execute illegal operations may result in injury or death.



Attention

Neglect this notice and execute illegal operations may result in injury, death and/or property damage.

Requirement in order to use the appliance safely and comfortably, please understand the content presented.

Australia:

✉ ozmyhomeappliances@gmail.com

🌐 www.gaslandchef.com.au

GASLAND



United States:

☎ 1(844) 538-7890

🌐 www.gaslandchef.com



## Additional Warnings

- Do not leave unattended when the appliance is operating.
- Do not use this appliance if it has damaged or worn seals.
- Do not use this appliance if it is leaking, damaged or does not operate properly.
- Do not operate from a non-upright position.
- CAUTION: Accessible parts may be very hot. Keep young children away.
- The exhaust gas and top of the appliance is hot! Do not place hands or any other object near the top of the appliance.
- Do not use in high wind conditions. Rated for up to 10 MPH.
- If there is a leak on your appliance (or smell of gas), immediately turn off the gas container valve, remove the appliance to a well-ventilated location away from any ignition sources. Check for leaks by using soapy water. Do not try to detect leaks using a flame.
- It may be hazardous to attempt to fit other types of gas containers.
- Gas container shall be changed in a well-ventilated location, preferably outside away from people and any sources of ignition, such as naked flame, pilot flames, electric heaters or similar equipment.
- Use ULPG gas only.
- Use outdoors only. The appliance do not suitable permanent fixed in one place. Do not use in a building, garage or any other inclosed area. Do not use in a mobile appliance, such as trolley or similar appliances. Never use this appliance as a heater.
- Only use the hose assembly as supplied with this appliance for connection to the container. Do not use adaptors.
- Gas regulator with 1500mm hose connection to the appliance with a shifting spanner, do not over tighten, this may cause damage in the gas regulator. Gently tighten with teflon tape, then spray soapy water as a leak detector.
- Avoid kinking and twisting the gas hose. Keep the fuel supply hose away from any heated surfaces.
- This appliance will be hot during and after use. Do not move the appliance when in use. Allow appliance to cool to 45°C before moving or storing.
- Should overheating occur or the gas supply fails to shut off turn off the gas supply at the gas container.
- Always cover the appliance when not in use, it must be protected from rain.

Australia:

 [ozmyhomeappliances@gmail.com](mailto:ozmyhomeappliances@gmail.com)

 [www.gaslandchef.com.au](http://www.gaslandchef.com.au)

**GASLAND**



United States:

 1(844) 538-7890

 [www.gaslandchef.com](http://www.gaslandchef.com)



- This appliance is to be stored in a dry and well ventilated location free from direct sunlight heat and ignition sources. If being stored indoors ensure that the location complies with as/nzs1596.
- This appliance must only be serviced by an authorized servicer.

## Use Precautions

### Check for gas leaks

1. Check seals between the appliance and the gas container are all the way on and in a good condition before connecting the gas container.
2. If the O-ring on the POL fitting of the gas hose is missing, damaged or worn, you must obtain a replacement from an authorized servicer. Suggest replace the O-ring on the fitting after use 12 months as the life expectancy.
3. For safely check for leaks, spray soapy water on the gas connection to see if bubbles appear. The information of bubbles indicated a gas leak. If there is a gas leak present, immediately shut off the gas container and do not try to operate the appliance. Do not try to detect leaks using a flame.
4. The connection points to check are:
  - Between the gas container and the gas hose
  - Between the washer and brass parts of the gas hose
  - Between the gas hose and the gas connector
  - Between the gas connector and the hot water system
5. There is a washer seal inside the gas hose connector. If the washer is missing, worn or damaged, you must obtain a replacement from an authorized servicer.
6. To check if gas remains in the container, disconnect from the appliance and hold the gas container in a vertical position then shake from side to side. If there a sound or feel of liquid movement inside the container contains gas.
7. Change the gas container outside in a well-ventilated location away from people and ignition sources, such as naked flames, pilot lights and electrical equipment such as heaters.



Australia:

✉ ozmyhomeappliances@gmail.com

🌐 www.gaslandchef.com.au



United States:

☎ 1(844) 538-7890

🌐 www.gaslandchef.com





## Avoid Scald

In order to avoid scalding, check the water temperature before showering. During the use or right after finish, do not touch the outer casing except the knobs to avoid scald. Children are often injured this way!

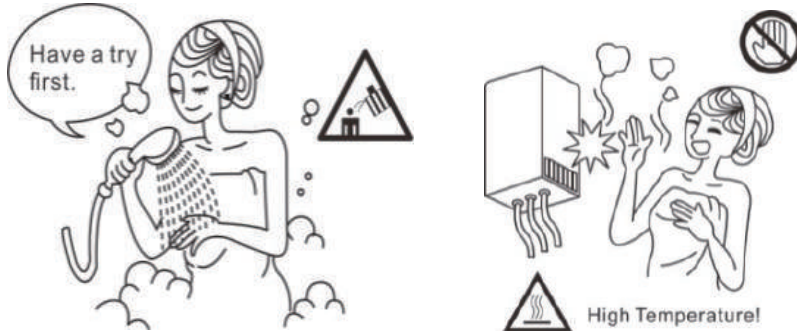

## Things To Do In An Abnormal Or Emergent Situation

1. Shut off both the water knob and the gas knob.
2. Do not use shower head.

To prevent accidents like fires, smoke, etc., the gas source, water source must all be cut off immediately in case any abnormality (like a fuming or smelling air inlet/ flue gas outlet pipe, etc.) is discovered, and an authorized servicer must also be contacted.

## Uses

Do not use this appliance for any purposes except for producing hot water.  
Do not modify this appliance.

## No Dismantling The Appliance

To avoid accidents, never dismantle the appliance without authorization.



Australia:  
 ✉ ozmyhomeappliances@gmail.com  
 🌐 www.gaslandchef.com.au

**GASLAND**



United States:  
 ☎ 1(844) 538-7890  
 🌐 www.gaslandchef.com



## Using Auxiliary Products

When using the appliance in low water pressure area, do not use shower head avoid scalding.

## Avoid Damage From Freezing Water

Be sure to drain off the residual water after each use in winter, to avoid damage to the appliance should the water freeze.

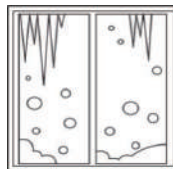

## Not Using For A Long Period

In order to prevent freezing water or gas leakage, please discharge accumulated water inside the appliance, cut gas and electricity supply when the appliance is not using for a long period.

## Gas Accident Prevention

Make sure it is combusting while using and flameout after use.

## Product Features & Appearance

### Product Features

1. Water controlled automatic ignition: applicable water pressure between 15kPa-1000kPa opens the ignition circuit for easy and convenient operation.
2. Pulse igniter, 100% rate of ignition.
3. Auto cut off protection, the auto cut off protection will shut the gas supply off immediately in the event of flameout of reduce the risk of gas leakage.
4. Removable drain valve to avoid water pipe and regulator damage caused by freezing water. Please do not adjust the screw inside of the drain plug, remove the plug as whole unit.
5. The water temperature can be adjusted freely.
6. Winter/Summer switch for energy saving during summer and winter time.
7. 20 minute timer, the appliance will be shut off automatically after 20 minutes of use.

Australia:

✉ ozmyhomeappliances@gmail.com

🌐 www.gaslandchef.com.au

GASLAND



United States:

☎ 1(844) 538-7890

🌐 www.gaslandchef.com



8. LED temperature display.
9. Handle for easy carrying during transportation.

## Safety Features

### 1. Auto-cut off protection

The auto-cut-off protection will shut off the gas supply immediately if the flame goes out for any reason.

### 2. Anti-dry combustion protection

Should dry combustion occur for any reason, the gas supply will be immediately and automatically shut off.

### 3. Anti-freezing protection

When the temperature is below freezing, remove the water discharge valve to discharge accumulated standing water inside the internal pipes. This will keep the appliance from freezing.

### 4. Over water pressure protection

When water pressure is over 1000kPa, the appliance will automatically relieve the excessive pressure to avoid damage to its internal components.

## Product Appearance & Dimension In Millimetre



Australia:

✉ [ozmyhomeappliances@gmail.com](mailto:ozmyhomeappliances@gmail.com)

🌐 [www.gaslandchef.com.au](http://www.gaslandchef.com.au)

**GASLAND**



United States:

☎ 1(844) 538-7890

🌐 [www.gaslandchef.com](http://www.gaslandchef.com)



## How To Use The Connector

### 1. Connector



Gas Inlet Connector  
BSP1/2"-5/8"-18UNF Male



Water Inlet Connector  
BSP1/2"-Ø9.5mm Male



Water Outlet Connector  
BSP1/2"-Ø9.5mm Male

For use with water input sources, such as 12V low voltage pump, please consult the pump instruction manual or contact [ozmyhomeappliances@gmail.com](mailto:ozmyhomeappliances@gmail.com)

### 2. Preparation

- Only use in well-ventilated areas. Carbon monoxide hazard-using this appliance in an inclosed space will cause death-do not use in caravans, tents, marine craft, cars, mobile homes or similar locations.
- Find a suitable sturdy, non-combustible vertical surface to hang the appliance on. The surface should be at least 1000mm clear from the sides and 1000mm from the top of all combustible surfaces, fabrics, flammable materials, and people.
- Use ULPG gas only.
- Open carton box (Picture 1) and remove appliance from the box and remove all transit material such as the plastic, foam and plastic connection end caps (Picture 2 & 3). Hang the appliance on a suitable vertical surface by the handle attached to the back cover of the appliance or handing kit (Picture 4).



Picture 1



Picture 2



Picture 3



Picture 4

Australia:

[ozmyhomeappliances@gmail.com](mailto:ozmyhomeappliances@gmail.com)

[www.gaslandchef.com.au](http://www.gaslandchef.com.au)

**GOSLAND**



United States:

[1\(844\) 538-7890](tel:1(844)538-7890)

[www.gaslandchef.com](http://www.gaslandchef.com)



- e. Install two “D” cell batteries (included) in the compartment on the bottom of the appliance. Check the batteries are facing the correct direction.
- f. Ensure the ignition switch located on the bottom of the appliance is turned to the “on” position.
- g. This appliance shall only be used with a butane or propane or butane/propane mix refillable gas container certificated to AS2030.1.
- h. Use shifting spanner to connect the gas inlet connector (Picture 5) and water inlet connector (Picture 6) before install gas supply line and water inlet hose to the appliance. Attached the flexible hose and regulator to the “Gas inlet” (Picture 7). Do not over tighten. Over tighten may causing a gas leak! Ensure that you use supplied washers (Picture 8-10) on all connectors and check for any gas smell before ignition as instruction. Make sure the gas inlet connector and water inlet connector are screwed all the way on.



Picture 5



Picture 6



Picture 7



Picture 8



Picture 9



Picture 10

- i. Connect the other end of the flexible hose and gas regulator to the gas container. Hand-tighten the connection in an anti-clockwise direction. Do not place the gas container directly beside or above the appliance.
- j. Connect the supplied shower head and flexible hose. Make sure to insert the supplied washer at the water outlet connection (Picture 11). After that, connect with the brass part at the bottom of the appliance marked “Water outlet” (Picture 12), the last step is use the shower fast connector(Picture 13) connect with the water outlet connector(Picture 14).



### Caution

Make sure the shower head direction is not face to the appliance during showering, to avoid the flameout problem.

Australia:

✉ ozmyhomeappliances@gmail.com

🌐 www.gaslandchef.com.au

GASLAND



United States:

☎ 1(844) 538-7890

🌐 www.gaslandchef.com





Picture 11



Picture 12



Picture 13



Picture 14

- k. Place at a comfortable height without putting stress on the gas hose.
- l. Before opening gas container valve, check the coupling nut for tightness. When appliance is not in use, turn off gas container valve on supply container. Do not try to detect leaks using a flame.
- m. Spray soapy water to test the gas leaks before operation, after make sure all parts are connected well, turn the gas container on in an anticlockwise direction one full turn.
- n. Never use gas container if visibly rusted, damaged or out of date.
- o. Clean and inspect the hose before each use. If there is evidence of abrasion, wear, cuts or leaks, the hose must be replaced prior to operation.

### 3. Starting

- a. Turn the gas valve on your gas container all the way open.
- b. Adjust the temperature of the water flowing from the shower head by turning the “gas” and “water” knobs.
- c. Turn the gas knob towards to “🔥” (symbol in Red) direction will increase gas flow. Turn the gas knob towards to “🔥” (symbol in Red) direction will decrease gas flow.
- d. Turn the water knob towards to “💧” (symbol in Blue) direction will increase water flow. Turn the water knob towards to “💧” (symbol in Blue) direction will decrease water flow.
- e. For higher temperature, increase the gas flow and decrease the water flow.
- f. Turn on the incoming water supply. Ensure that you have adequate water pressure between 15kPa-1000kPa.
- g. Once water is flowing through the system, the appliance will ignite. During ignition there will be a series of audible clicks and then the burner will ignite. If the burner does not ignite after 5 seconds, refer the section on trouble shooting.

Australia:

✉ ozmyhomeappliances@gmail.com

🌐 www.gaslandchef.com.au

**GASLAND**



United States:

☎ 1(844) 538-7890

🌐 www.gaslandchef.com





### ⚠️ Caution

Take care to test the temperature of the water follow from the shower head, as it may be hot enough to cause scalded.

## 4. Winter/summer temperature control

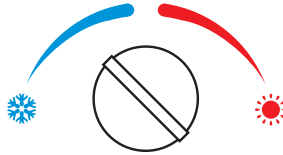

- This model has Winter/Summer switch, the user can adjust the appliance use of water and gas until it's comfortable.
- In case those who install the water valves themselves, cold water should not be turned up too much, in order to avoid the less pressure by diffluent will affect this appliance's normal running.
- In some place, the water pressure may be too strong and thus water cannot be heated. In this case, please turn down the water-in valve.

## 5. Shut off

To temporarily stop the operation of this appliance, merely shut off water knob control or water inlet valve to cease water flow and the flame fire will extinguish automatically.

After you have finished using the water, please shut off the water knob control and gas knob control.

### ⚠️ Caution

The appliance should not be used continuously for an extended period so as to ensure its lifetime.



## 6. Storage

- a. After using, turn the gas container valve in a clockwise direction to the “off” (close) position. The burner will continue to operate until all gas has been bled from the hose and regulator assembly.
- b. Wait for the flame to go out, after that to turn the appliance control valve(s) off.
- c. Disconnect the shower hose from the “water output”, allow all water to drain out from hosing before rolling up and storing away.
- d. Disconnect the regulator and hose assembly from the appliance and gas container and store away.

## 7. Disconnecting from gas container

1. Check the appliance is fully extinguished, the gas container control valve is in the fully “off” position and all surfaces are cool enough.
2. Loosen the connection to the gas container in a clockwise direction.

# Daily Inspection & Maintenance

The appliance, gas pipes and hoses should be checked and maintained by an authorized servicer every 6-12 months. If you find joints that are not tightly secured or if there are cracks or corrosion anywhere, you should stop using the appliance and perform the necessary maintenance immediately.



### Caution

The appliance will still be hot shortly after use. Avoid draining off the residual water until the water cools down, to avoid being scalded.

Users should regularly using the soapy water to wipe on connecting part of each pipe to test whether has the gas leakage.

- Clean the accumulated dirt and dust on the casing of the appliance by cloth regularly. Do not use chemical or volatile solvent.
- Use a neutral detergent to clean all surfaces and areas then wipe it dry. Taking care not to allow water to enter the top vent.
- Before each use, check the stainless steel filter on the “Water input” pipe is in place and clean if have any particles.
- Do not submerge the appliance in a sink or container.
- Do not use abrasive cleaners or bleach.



Australia:

✉ ozmyhomeappliances@gmail.com

🌐 www.gaslandchef.com.au



United States:

☎ 1(844) 538-7890

🌐 www.gaslandchef.com





### Note

Do not drop dirt and dusts into the fire holes of burner and electric parts, do not loosen or damage other parts as well. To re-fix the parts after cleaning, refer to the installation requirements.

## Draining The Appliance Avoid Frozen Broken Below 0°C

1. During the stage of no using, the temperature is same between the inside and outside of the appliance, the water will expand when temperature reach 0°C, even broken the water pipe.
2. Operate the drain plug at the base of the appliance to drain off the residual water from the appliance and then screw it tightly if the environment where the appliance is installed drops below 0°C. This can prevent the cold from damaging the appliance. Failure to do so will avoid your warranty.



## Before Operate The Drain Plug, Must Be

1. Ensure that the appliance is disconnected from the gas supply.
2. Ensure that the appliance is disconnected from the water supply.
3. Ensure that the shower hose is disconnected from the appliance.

Australia:

✉ [ozmyhomeappliances@gmail.com](mailto:ozmyhomeappliances@gmail.com)

🌐 [www.gaslandchef.com.au](http://www.gaslandchef.com.au)

GASLAND



United States:

☎ 1(844) 538-7890

🌐 [www.gaslandchef.com](http://www.gaslandchef.com)



## Following Phenomena Are Not Real Troubles

Protective function	Reaction	How to do
Water pressure too high	If water pressure is over 1000kPa, the water-out valve will release water and adjust to lower pressure	Increase the valve pressure limit according to local water supply pressure
20-minute automatically shut off	After 20 minutes' using, water heater will shut off automatically for safety purpose	Re-start the appliance
Water pressure too low	Check that the water pressure is at least 15kPa to activate the burners	Use the appliance later when pressure becomes higher
Low battery	The power of battery will become less after use for some time, thus the appliance cannot be ignited	Change battery and make sure new battery installed in the correct position
Over heat protection	The appliance automatically shuts off when water temperature is over ( $77\text{ }^{\circ}\text{C} \pm 3\text{ }^{\circ}\text{C}$ )	Re-start the appliance later when water becomes cooler



Australia:

✉ [ozmyhomeappliances@gmail.com](mailto:ozmyhomeappliances@gmail.com)

🌐 [www.gaslandchef.com.au](http://www.gaslandchef.com.au)

**GASLAND**



United States:

☎ 1(844) 538-7890

🌐 [www.gaslandchef.com](http://www.gaslandchef.com)



# Troubleshooting Guide

This guide should be followed in case of failure of the appliance to operate correctly. For more information, please refer to Service Manual or contact service provider.

Causes		Malfunction												
		A	B	C	D	E	H	F	H	I	J			
Improper Operation	Overall fuel gas valve is unopened		•											Open overall valve of gas supply
	Water supply valve is unopened		•											Open valve of water supply
	Improper regulation method of water temperature					•								Enlarge gas volume, reduce water volume
								•						Reduce gas volume, enlarge water supply
	Electrical leakage protective switch is not restored		•											Restoration of electric leakage protective switch
	Improper position of water switch		•											Turn water knob to hot water point
Surroundings	Air exiting inside fuel gas pipe		•	•										Repeat opening and closing water knob for several times
	Inadequate fresh air supply					•								Improve ventilation and ensure air supply
	Fuel gas pressure	Too high	•	•			•		•					Regulate pressure relief valve, reduce overall gas supply
		Too low				•	•			•				Check if gas rubber pipe twists or not
	Water pressure	Too high				•								Reduce water supply
		Too low	•	•		•				•	•			Utilize when water pressure recovers to normal





Surroundings	Inadequate supply of fuel gas	Gas valve is half opened																			Open gas valve completely	
		Too long pipe																				Shorten rubber pipe
		Too small through diameter of joints																				Displace joints of rubber pipe
		Simultaneous consumption of fuel gas by several users																				Stop other users' using fuel gas
	Blockage of water route system																				Clean filtration net on water admitting orifice	
	Blockage of shower																				Clean shower device	
	Blockage of vent pipe																				Clean flue pipe	
	Inadequate battery voltage																				Displace batteries	
Safety protection	Too low water temperature																				Reduce water volume	
	Exorbitant air pressure protective device																				Utilize when air pressure recovers to normal	
	Electrical leakage protective device works																				Ask for authorized person to repair it	
	Heat protective switch works																					
Other causes	20 minute timer protective device works																				Restart water control knob	
																					Ask for authorized person to repair it	
<p>A. Ignition failure                      B. Blasting combustion                      C. Flameout during operation                      D. Too low temperature                      E. Too high temperature                      F. Sparks from fire peep hole                      G. Removed flame and renegade fire                      H. Returned fire                      I. Other malfunctions                      J. Flameout at point of large water volume</p>																						

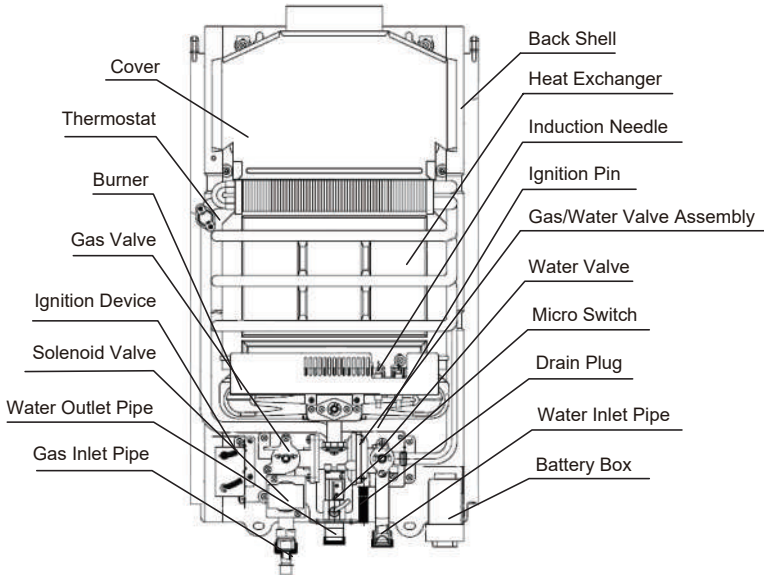

# Major Components



# Major Technical Parameter

Portable Gas Hot Water Heater		Certification
Model	BE Seires	 
Gas type	ULPG	
TTP(kPa)	2.75	
Capacity	8L/min	
Total nominal gas consumption	30 MJ/h	
Injector size	0.63mm	
Minimum water pressure	15kPa	
Maximum water pressure	1000kPa	
Manufacturer	Junsky	

Remark:

1. Gas type and rated pressure should be according to the parameter on the appliance's body.
2. Above is he standard configuration of a full set of this appliance, the actual configuration would be different according to different areas.
3. It may be hazardous to attempt to fit other types of gas containers.

Australia:

✉ ozmyhomeappliances@gmail.com

🌐 www.gaslandchef.com.au

**GASLAND**









United States:

☎ 1(844) 538-7890

🌐 www.gaslandchef.com



## In The Box

Item	Description	Identification	Quantity	Remarks
A	Portable gas hot water heater		1 piece	
B	Bonus on/off switch shower head with 1500mm hose		1 set	
C	AGA Gas regulator with 1500mm hose		1 set	
D	Gas connector		1 piece	
E	Water inlet connector Water outlet connector		1 set	Blue for inlet Red for outlet
G	Washer		2 pieces	
H	Handing kit		1 set	Not required for operation

Australia:

✉ ozmyhomeappliances@gmail.com

🌐 www.gaslandchef.com.au

**GASLAND**



United States:

☎ 1(844) 538-7890

🌐 www.gaslandchef.com



## Warranty Information

The appliance comes with a 2 years limited warranty, provided it has been operated and maintained as per the manufacturer's specifications outlined in the instruction manual.

In the event of defects arising from faulty workmanship and/or materials for a period of 2 years from the date of purchase, Camplux will replace or repair the appliance free of charge. In accordance with Australian Consumer law, you are entitled to a refund or a replacement in the event of a major failure, and compensation for any other reasonably foreseeable loss or damage. You are also entitled to have the unit replaced or repaired if it fails to be of acceptable quality and the failure does not amount to a major failure.



Australia:

✉ [ozmyhomeappliances@gmail.com](mailto:ozmyhomeappliances@gmail.com)

🛒 [www.gaslandchef.com.au](http://www.gaslandchef.com.au)



United States:

☎ 1(844) 538-7890

🛒 [www.gaslandchef.com](http://www.gaslandchef.com)





# **GASLAND** outdoors



Scan me



1 (844) 538-7890

[www.gaslandchef.com](http://www.gaslandchef.com)

[support@gaslandchef.com](mailto:support@gaslandchef.com)

3330-A Marathon Ct Charleston, SC 29418

