



MADE.IN

INTERIOR LANDSCAPE



ARCHITESSA

 **LANDMARK**  
CERAMICS

The logo for Landmark Contemporary features a stylized red and white icon to the left of the word "LANDMARK" in a bold, black, sans-serif font. Below "LANDMARK", the word "CONTEMPORARY" is written in a smaller, white, sans-serif font inside a grey rectangular box.

# LANDMARK

CONTEMPORARY

"Contemporary" is a gathering of porcelain tile collections for floors and walls that draws inspiration from modern living trends. Different materials allow for expression with renewed personality the soul of architecture interior design with a new mood. The "Landmark Contemporary" porcelain tiles feature different surface look that coexists together with other materials while the space is decorated with the latest trends and metropolitan characteristics.

## A new landmark in the ceramic industry

Landmark ceramics is an American company, based in Tennessee that has set out to research, manufacture and sell top quality porcelain ceramics in North America, taking advantage of the proven experience of the Gruppo Concorde, an international leader in the sector. Technological innovation, market presence, attention to detail, the welfare of people and the environment, efficient service and a thorough product range make Landmark a new benchmark in the North American market for those who are looking for a reliable partner for any building and architecture project using US made top quality porcelain tiles.

The text "MADE.IN" is displayed in a large, white, serif font, with "INTERIOR LANDSCAPE" in a smaller, white, sans-serif font below it. The background is a black and white photograph of light rays filtering through a window, creating a pattern of light and shadow on a dark surface.

# MADE.IN

INTERIOR LANDSCAPE

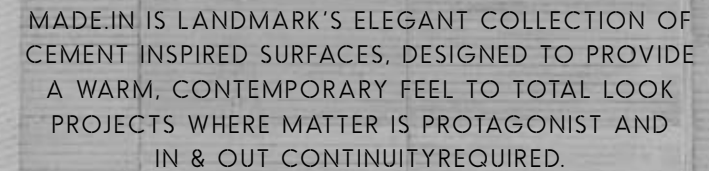
The text is centered over a black and white photograph of a modern building's exterior. The building features large, rectangular panels with a textured, cement-like finish. The lighting creates strong shadows and highlights, emphasizing the geometric forms and textures of the architecture.

MADE.IN IS LANDMARK'S ELEGANT COLLECTION OF CEMENT INSPIRED SURFACES, DESIGNED TO PROVIDE A WARM, CONTEMPORARY FEEL TO TOTAL LOOK PROJECTS WHERE MATTER IS PROTAGONIST AND IN & OUT CONTINUITY REQUIRED.

URBAN ENVIRONMENTS OF REFINED TASTE, MODERN SETTINGS WHERE MINIMALISM PROVIDES A FEELING OF COZINESS, ELEVATING SPACES TO OFFER A WELCOMING ATMOSPHERE TO INTERIORS AND EXTERIORS WITHIN COMMERCIAL OR RESIDENTIAL REALITIES. MADE IN IS THE COLLECTION THAT COMBINES THE AESTETICHS OF FORMAL CONCRETE WITH THE EXPECTATIONS OF PORCELAIN TILES.

MADE. TO ENHANCE  
MADE. TO DESIGN  
MADE. TO LAST  
MADE. TO IMPRESS  
MADE. TO COMBINE  
MADE. FOR IN & OUT  
**MADE. IN LANDMARK**



CONTEMPORARY



ESSENTIAL

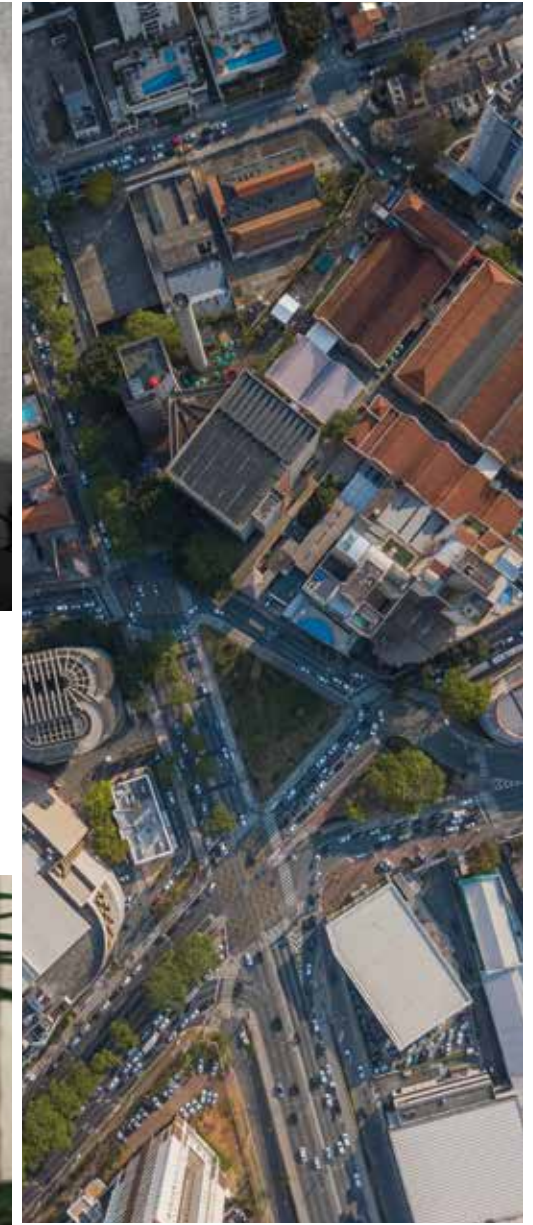

RELIABLE

MADE. TO ENHANCE

## IN BETWEEN URBAN LANDSCAPES



NEAT REALITIES OF ELEGANT DESIGN, REPRESENTATIVE OF CONTEMPORARY ATMOSPHERES AND TREND-SETTING URBAN ENVIRONMENTS. THE LOOKS OF MADE.IN FIND INSPIRATION IN REFINED INDUSTRIAL CONCRETE WHERE DETAILS AND SHADES ARE WISELY BALANCED FOR A CONTEMPORARY AND REFINED ATMOSPHERE BOTH INDOOR AND OUTDOOR, IN COMMERCIAL OR RESIDENTIAL SPACES, FOR FLOORS AND WALLS.



**PROJECT**  
FLOOR DESIGN  
Made.In Passion Silver - 24"x48"  
Made.In Liberty Black - 24"x24"  
WALL DESIGN  
Made.In Liberty Black - 24"x24"



**PROJECT**

FLOOR DESIGN

Made.In Passion Silver - 24"x48"

Made.In Liberty Black - 24"x24"

WALL DESIGN

Made.In Liberty Black - 24"x24"

## CONTEMPORARY REFINEMENT

**PROJECT**  
FLOOR DESIGN  
Made.In Passion Silver - 24"x48"  
Made.In Liberty Black - 24"x24"  
WALL DESIGN  
Made.In Liberty Black - 24"x24"



MADE. TO DESIGN

## DOWNTOWN CREATIVITY



EXPLORE INNOVATIVE COMBINATIONS THANKS TO A WIDE VARIETY OF COLORS, MONOCALIBER AND RECTIFIED SIZES. CREATIVE COMMERCIAL OR RESIDENTIAL SETTINGS THAT STRIKE A UNIQUE BALANCE BETWEEN DYNAMIC MODERN LIFESTYLE AND INNER WELLBEING THANKS TO THE EQUILIBRIUM BETWEEN GRAPHICS AND COLORS.



**PROJECT**  
FLOOR DESIGN  
Made.In Vision Grey - 24"x48"  
Made.In Vision Grey Mosaic A - 12"x12"



**PROJECT**

FLOOR DESIGN

Made.In Vision Grey - 24"x48"

Made.In Vision Grey Mosaic A - 12"x12"

WALL DESIGN

Made.In Vision Grey - 24"x48"

COUNTER DESIGN

Made.In Vision Grey Mosaic A - 12"x12"

Made.In Vision Grey - 12"x24"



MODERN  
MINIMALISTIC  
WHOLENESS

**PROJECT**  
FLOOR DESIGN  
Made.In Vision Grey - 24"x48"  
Made.In Vision Grey Mosaic A - 12"x12"



MADE.IN

MADE. TO LAST

FIND THE COMFORT WITHIN



WARM, COZY ATMOSPHERES TO CUDDLE YOU WITHIN THE COMFORT OF YOUR WALLS. A DELICATE COLOR PALETTE TO DESIGN ELEGANT SETTINGS AND REFINED SURFACES, ACHIEVING MINIMALISTIC COMBINATIONS OF SHADES AND LOOKS. MADE.IN IS A COLLECTION MANUFACTURED WITH THE MOST REFINED INGREDIENTS, TO ACHIEVE HIGH QUALITY PORCELAIN TILES MADE TO RESIST EVERYDAY LIFE THANKS TO THE SUPERIOR FEATURES OF LANDMARK'S PORCELAIN.



**PROJECT**

FLOOR DESIGN

Made.In Heritage Beige - 24"x24"

Made.In Heritage Beige Mosaic A - 12"x12"

WALL DESIGN

Made.In Heritage Beige - 12"x24"



**PROJECT**

**FLOOR DESIGN**

Made.In Heritage Beige - 24"x24"

Made.In Heritage Beige Mosaic A - 12"x12"

Emotion Relax Beige - 8"x40"

**WALL DESIGN**

Made.In Heritage Beige - 12"x24"

Made.In Heritage Beige Mosaic A - 12"x12"

WARM  
ENVELOPING  
SURFACES



**PROJECT**  
FLOOR DESIGN  
Made.In Heritage Beige - 24"x24"  
Made.In Heritage Beige Mosaic A - 12"x12"  
Emotion Relax Beige - 8"x40"  
WALL DESIGN  
Made.In Heritage Beige - 12"x24"  
Made.In Heritage Beige Mosaic A - 12"x12"



MADE. TO IMPRESS

## COMBINATIONS AND CONSISTENCY



MADE IN IS STUDIED FOR TOTAL LOOK SOLUTIONS INDOOR AND OUTDOOR WITHIN UNIQUE SPACES OF CONTEMPORARY TASTE. THANKS TO THE WIDE OFFER OF FINISHES, MATT, GRIP AND FRONTIER20, MADEIN IS PERFECT FOR INDOOR OR OUTDOOR APPLICATION, FOR BOTH FLOORS AND WALLS, ANYWHERE HIGHER PERFORMANCES ARE REQUIRED. SPACE, COLOR AND LOOK TRANSITION HAS NEVER BEEN EASIER.



### PROJECT

FLOOR DESIGN

Made.In Liberty Black - 24"x24"

Made.In Passion Silver - 24"x48"

WALL DESIGN

Made.In Liberty Black Mosaic A - 12"x12"

Made.In Passion Silver - 24"x48"



**PROJECT**

FLOOR DESIGN

Made.In Liberty Black - 24"x24"

Made.In Passion Silver - 24"x48"

WALL DESIGN

Made.In Liberty Black - 12"x24"

Made.In Liberty Black Mosaic A - 12"x12"

Made.In Passion Silver - 24"x48"

# IN & OUT CONTINUITY



**PROJECT**  
OUTDOOR FLOOR DESIGN  
Frontier20 Passion Silver - 24"x24"  
INDOOR FLOOR DESIGN  
Made.In Passion Silver - 24"x48"  
WALL DESIGN  
Made.In Passion Silver - 24"x48"



MADE.IN

MADE. TO COMBINE

TRENDSETTING VERSATILITY



**PROJECT**  
FLOOR DESIGN  
Made In Freedom White - 24"x48"





**PROJECT**

FLOOR DESIGN

Made.In Freedom White - 24"x48" - 12"x24"

WALL DESIGN

Veneer World Quarry LedgeStone River Smoke - 6"x24"

LARGER  
THAN LIFE



**PROJECT**  
FLOOR DESIGN  
Made.In Freedom White - 24"x48"  
WALL DESIGN  
Veneer World Quarry Ledgestone River Smoke - 6"x24"



MADE. FOR IN & OUT

# NATURAL FEELING



IN & OUT CONTINUITY IS A PRESTIGIOUS FEATURE OF LANDMARK'S COLLECTIONS, THANKS TO THE GRIP FINISH OR FRONTIER20. MADE. IN FINDS NEW WAYS TO BRING INDOOR AND OUTDOOR TOGETHER, CREATING LOOKS THAT PROVIDE A SENSE OF CONTINUITY WITHOUT COMPROMISING QUALITY OR SAFETY.

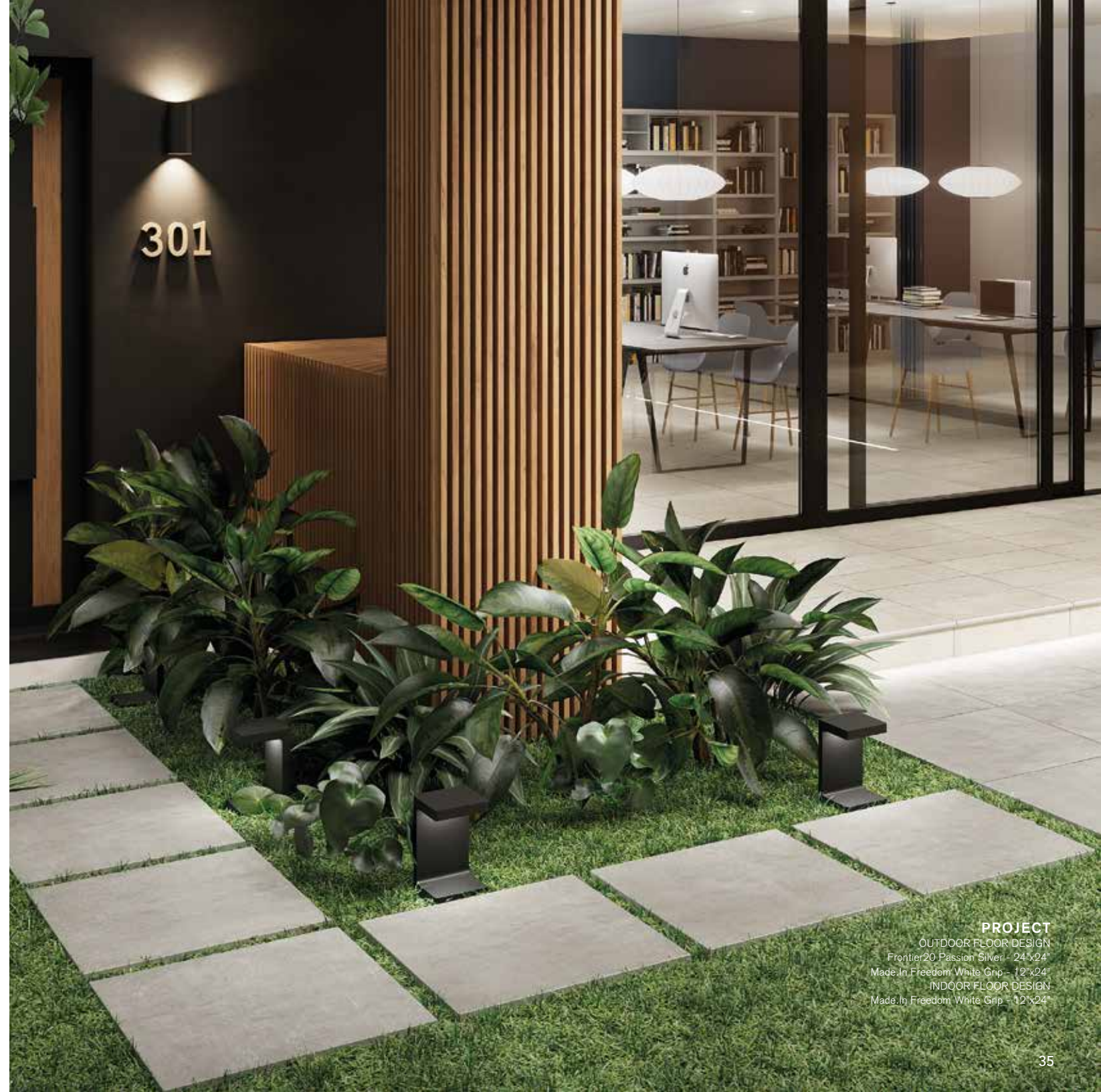

**PROJECT**  
OUTDOOR FLOOR DESIGN  
Frontier20 Passion Silver - 24"x24"  
Made.In Freedom White Grip - 12"x24"  
INDOOR FLOOR DESIGN  
Made.In Freedom White Grip - 12"x24"



**PROJECT**

OUTDOOR FLOOR DESIGN  
Frontier20 Passion Silver - 24"x24"  
Made.In Freedom White Grip - 12"x24"  
INDOOR FLOOR DESIGN  
Made.In Freedom White Grip - 12"x24"

**SUSTAINABILITY**



**RECYCLABLE**

Tiles can be recycled inside the production process when not fired yet, or once they have finished their life-cycle can be used as compact base material on the contrary many plastic base material such as vinyl cannot.

**SUSTAINABILITY**



**ECO-FRIENDLY AND SAFE**

**SUSTAINABILITY**



**ENERGY EFFICIENT**

Tile's inherent thermal mass reduces peak heating and cooling, which helps moderate temperature swings in your home.

**HEALTH**



**NATURAL INGREDIENTS**

Tile is made of clays and other naturally-occurring minerals and does not contain chemicals with potential adverse health effects (pvc, voc, formaldehyde, plastic etc...)

**SAFETY/DURABILITY**



**SCRATCH AND DENT RESISTANT**

Tile is strong, hard and resistant to most type of scratches. Tile also, being an extremely dense material, doesn't fear any denting damage, like many others flooring materials do.

**SAFETY/DURABILITY**



**FADE AND UV RESISTANT**

**SUSTAINABILITY**



**FLOOR HEAT FRIENDLY**

**SUSTAINABILITY**



**VERY LONG SERVICE LIFE**

Tile when properly installed and maintained can last for decades.

**SUSTAINABILITY**



**COST SAVING OVER TIME**

Thanks to its long service life and easy maintenance, porcelain tile is very cost effective over time when compared to flooring products that need to be replaced more frequently.

**SAFETY/DURABILITY**



**RESISTANT TO ACID**

**SAFETY/DURABILITY**



**WATER PROOF**

Tile is very compact and impervious therefore doesn't absorb. With tile you'll never have to worry about water.

**SAFETY/DURABILITY**



**FIRE PROOF**

Tile doesn't burn, melt or give off toxic fumes when exposed to fire.

**HEALTH**



**PREVENT BACTERIA GROWTH**

Tile is completely inhospitable to bacteria. That means no mold or mildew, and a healthier home for you.

**HEALTH**



**ZERO ALLERGENES**

Tile is both hard and impervious therefore inhospitable to dust mites, bacteria, fungi, mold and other irritants.

**HEALTH**



**ZERO SMOKE DEVELOPMENT**

Tile never gives off toxic fumes, even when exposed to fire.

**SAFETY/DURABILITY**



**DOESN'T BEND**

Tile is hard and compact.

**SAFETY/DURABILITY**



**PET FRIENDLY**

Tile is both dog and cat scratch proof.

**SAFETY/DURABILITY**



**RESISTANT TO FROST**

Tile is snow and ice proof.

**HEALTH**



**ZERO FORMALDEHYDE**

Formaldehyde is known to lead to an increased incidence of asthma. Tile has zero formaldehyde.

**HEALTH**



**ZERO PVC ZERO VOC**

Tile is completely PVC and VOC (volatile organic compound) free that means a healthier home for you.

**HEALTH**



**PLASTIC FREE**

Tiles are free from any PBM (Plastic Base Material) materials used in vinyl and LVT.

**EASY CARE**



**STAIN RESISTANCE**

**EASY CARE**



**EASY TO KEEP CLEAN**

**VERSATILITY**



**FLOOR AND WALL**

Tile is ideal for both floor and wall application indoor and outdoor.

## FREEDOM WHITE

## HERITAGE BEIGE



### Available sizes



24"x48"  
MATT  
± 0.35" / 9 mm

24"x24"  
MATT  
± 0.35"

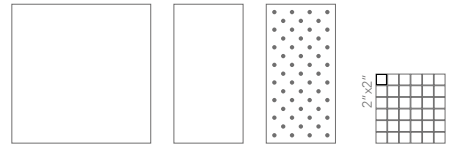

24"x24"  
FRONTIER20  
± 0.8" / 20 mm

12"x24"  
MATT  
± 0.35"

12"x24"  
GRIP  
± 0.35"

12"x12"  
MOSAIC A  
± 0.35"

The color of tiles printed in this catalog may differ from actual tiles. Tile color reproductions in this catalog are representative only. Slight tone and shade variations are inherent in porcelain tiles. Before selecting a color, we recommend that you contact your local representative, who will provide you with a sample piece of the requested tile.

### Color shading



### Available sizes

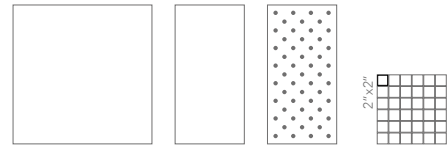

24"x24"  
MATT  
± 0.35"

12"x24"  
MATT  
± 0.35"

12"x24"  
GRIP  
± 0.35"

12"x12"  
MOSAIC A  
± 0.35"

This porcelain tile product is manufactured with a V2 shade variation. Remember that the amount of color as well as the texture of each piece may vary from tile to tile. Inspect the product immediately upon delivery and select tiles from many boxes during installation to minimize and blend any possible color difference.

### Color shading



## PASSION SILVER



## VISION GREY



### Available sizes



24"x48"  
MATT  
± 0.35" / 9 mm

24"x24"  
MATT  
± 0.35"

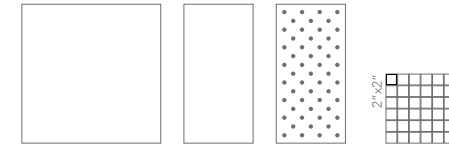

24"x24"  
FRONTIER20  
± 0.8" / 20 mm

12"x24"  
MATT  
± 0.35"

12"x24"  
GRIP  
± 0.35"

12"x12"  
MOSAIC A  
± 0.35"

### Color shading



### Available sizes



24"x48"  
MATT  
± 0.35"

24"x24"  
MATT  
± 0.35"

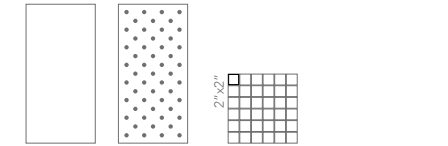

12"x24"  
MATT  
± 0.35"

12"x24"  
GRIP  
± 0.35"

12"x12"  
MOSAIC A  
± 0.35"

### Color shading



### Color Shading



UNIFORM APPEARANCE



SLIGHT VARIATION



MODERATE VARIATION



SUBSTANTIAL VARIATION

LIBERTY BLACK



Available sizes

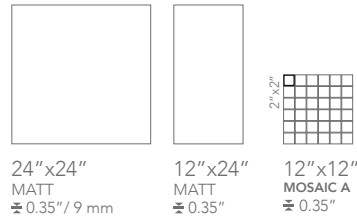

Color shading

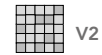

The color of tiles printed in this catalog may differ from actual tiles. Tile color reproductions in this catalog are representative only. Slight tone and shade variations are inherent in porcelain tiles. Before selecting a color, we recommend that you contact your local representative, who will provide you with a sample piece of the requested tile.

This porcelain tile product is manufactured with a V2 shade variation. Remember that the amount of color as well as the texture of each piece may vary from tile to tile. Inspect the product immediately upon delivery and select tiles from many boxes during installation to minimize and blend any possible color difference.

Color Shading



Freedom White  
Mosaic A 2"x2"  
12"x12"



Heritage Beige  
Mosaic A 2"x2"  
12"x12"



Passion Silver  
Mosaic A 2"x2"  
12"x12"



Vision Grey  
Mosaic A 2"x2"  
12"x12"

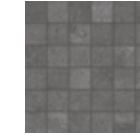

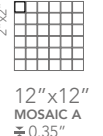

Liberty Black  
Mosaic A 2"x2"  
12"x12"



12"x12"  
MOSAIC A  
±0.35"

TRIM TILES

MATT FINISH

	COVE BASE  6"x12"	BULLNOSE  3"x24"
FREEDOM WHITE	•	•
HERITAGE BEIGE	•	•
PASSION SILVER	•	•
VISION GREY	•	•
LIBERTY BLACK	•	•

### RECOMMENDED USE

Made.In matt finish is recommended for indoor floors, walls, countertops, and outdoor walls in commercial and residential applications. The use of Made.In matt finish is not recommended for outdoor floors (for that application use Grip finish or Frontier20). Landmark recommends an offset no greater than 30%, if a staggered pattern is required for tiles of 20" inches or longer. Landmark recommends the use of leveler for a proper installation.









### CARE AND MAINTENANCE

Do not apply any wax or sealer to the product after installation. Regular cleaning is the best way to keep tiles looking good. Use clean, hot water (add household cleaner for more aggressive cleaning). Rinse thoroughly and dry with a soft cloth to prevent water spots. Please visit [lcusa.com](http://lcusa.com). For further information regarding the care and maintenance of Landmark products.

### WARRANTY

Landmark guarantees that its products will meet or exceed the performance specifications set out in ANSI A137.1- 2012 and in the performance specifications section of the Landmark general catalog. For more information, please visit our website at [lcusa.com](http://lcusa.com).



PHYSICAL PROPERTIES	TEST ASTM	NORTH AMERICAN STANDARD A137.1*	RESULTS
 Water absorption *	C373	≤ 0.5%	COMPLY WITH ANSI A137.1
 DCOF Average dynamic coefficient of friction **	BOT 3000 test	≥ 0.42	≥ 0.42
 Resistance to freeze/thaw cycling *	C1026	As reported	RESISTANT
 Warpage (edge)	C485	Warpage ± 0.4% or ± 0.05 in	COMPLY WITH ANSI A137.1
 Warpage (diagonal)	C485	Warpage ± 0.4% or ± 0.07 in	COMPLY WITH ANSI A137.1
 Wedging	C502	± 0.25% or ± 0.03 in	COMPLY WITH ANSI A137.1
 Chemical resistance	C650	As reported	UNAFFECTED
 Breaking strength	C648	250 lbf or greater	COMPLY WITH ANSI A137.1
 Thickness	C499	Range: 0.04 in	COMPLY WITH ANSI A137.1

\* Average values referred to our production and related to the matt finish of the product.

\*\* As far as values relating to the matt finish of the product and to tests carried out by certified external laboratories whose results are available upon request at Headoffice, we are willing to check the lot you are interested in purchasing.

- Be sure to use tiles belonging to the same caliber.
- Test results are available on request.
- Landmark tiles can be slippery when wet. We recommend to make sure that the surface is always dry.
- The information provided can be subject to change. Please refer to [lcusa.com](http://lcusa.com) for the latest, most accurate and up-to-date information.



PASSION SILVER  
VISION GREY







## CONTACT INFORMATION:

[www.architessa.com](http://www.architessa.com)

1.800.287.1742

For general sales inquiries: [sales@architessa.com](mailto:sales@architessa.com)

For commercial & hospitality sample requests: [samples@architessa.com](mailto:samples@architessa.com)