

NOMAD SYSTEM FELT

Parts List:

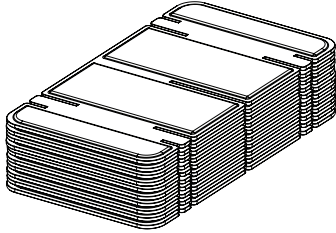

10 x Felt Modules

1

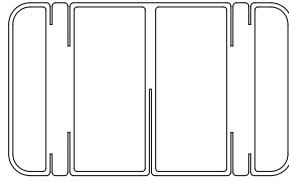

Unpack the Nomad System by cutting tape carefully to avoid damaging modules.

2

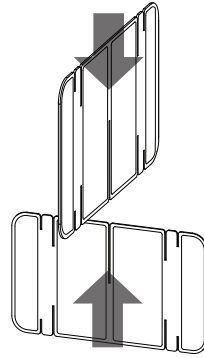

Insert one module into the other along the central slot creating an X assembly shown. Repeat this step for all modules.

3

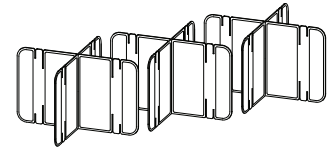

Arrange one row of X assemblies in the desired wall perimeter. Leave approximately one inch (2.5 cm) between X assemblies.

Closed Assembly:

4

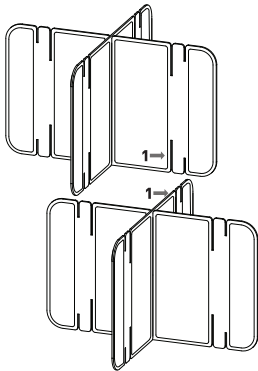

Insert subsequent rows of X assemblies into the bottom row. Use the long side slots (#1) for closed assemblies. Repeat this step to desired height.

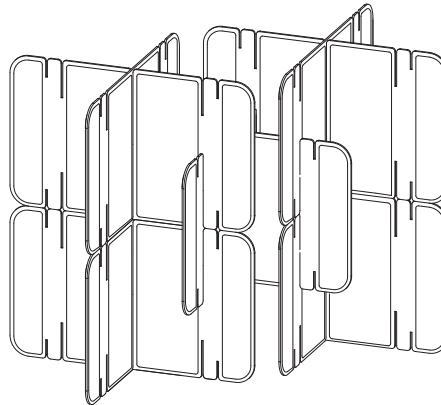

Single box closed assembly

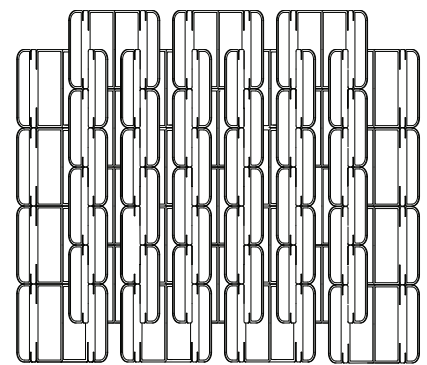

Finished! Use the selected slot throughout the entire assembly. Each box contains 5 sqf [.46 sqm] in the closed assembly.

Open Assembly:

4

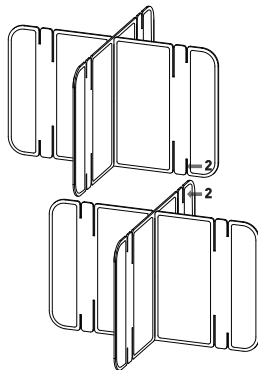

Insert subsequent rows of X assemblies into the bottom row. Use the short side slots (#2) for open assemblies. Repeat this step to desired height.

5

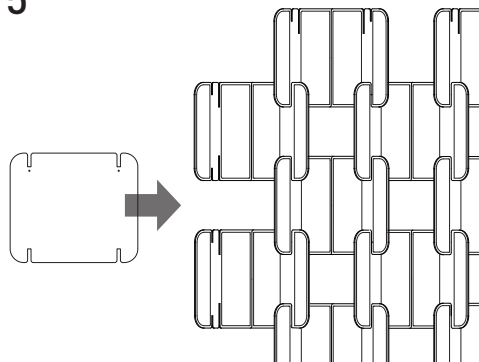

Insert aluminum spacers at the end of each open row to prevent sagging and improve stability.

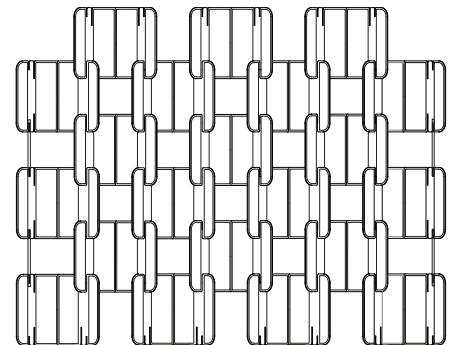

Finished! Use the selected slot throughout the entire assembly. Each box contains 7 sqf [.65 sqm] in the open configuration.



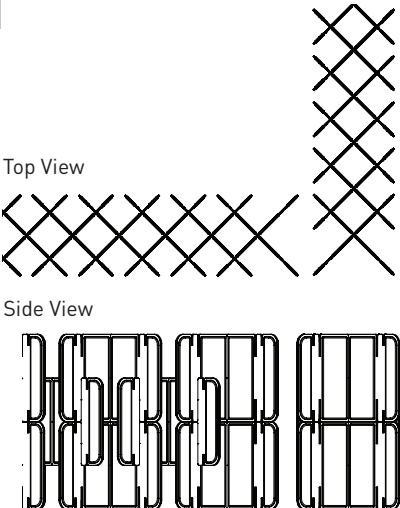
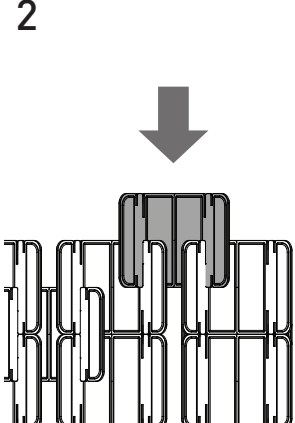
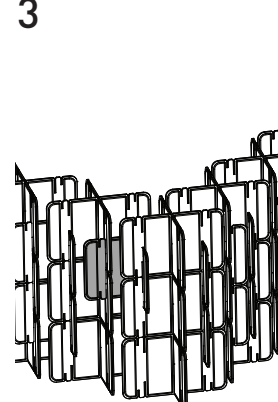
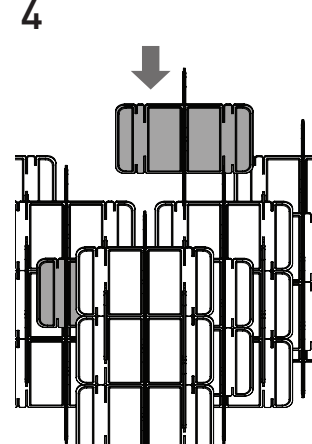

NOMAD SYSTEM FELT

Turning Corners:

<p>1</p>  <p>Top View</p> <p>Side View</p> <p>Arrange two walls at a 90 degree corner and build them two modules high.</p>	<p>2</p>  <p>Connect the walls together using an X assembly.</p>	<p>3</p>  <p>Continue building the wall with another row of modules.</p>	<p>4</p>  <p>Add another X assembly to the opposing connection point. Repeat steps 2-4 to desired height.</p>
--	--	---	---

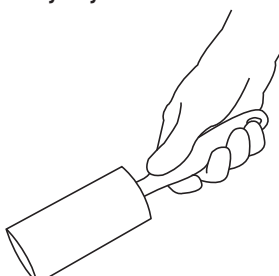
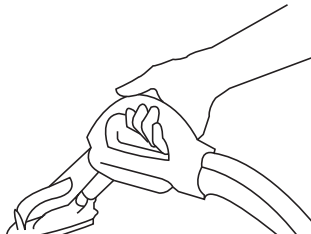
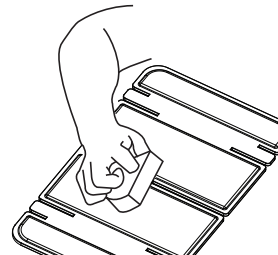
How to Clean:

<p>Everyday Care</p>  <p>Vacuum modules with a handheld attachment to avoid dust and dirt buildup, especially in high traffic area installations. Alternatively lint, dirt, hair, or fuzz can be easily removed with a lint roller or tape.</p>	<p>Spot Cleaning</p>  <p>Spot clean to eliminate small stains or dirt. Start by removing loose dirt with a vacuum. Wet a soft cloth, with warm water, and dab the stain. Repeat until the stain has been removed. Tougher stains can be removed using a small amount of delicate hand-washing detergent.</p>	<p>Washing Modules</p>  <p>Soiled modules can be washed in a sink. Use warm water and clean by dabbing with cloth or absorbent material. Remove excess moisture with a dry towel. Lay modules to dry on a flat surface with absorbent material below. Turn modules over periodically until they are completely dry. Do not scrub.</p>	<p>Disinfecting Modules</p>  <p>Nomad System Felt can be cleaned with alcohol or a 1:10 bleach and water solution (approximately 5000 ppm) for high disinfection. For best results leave the solution at least one minute on the module surfaces. Clean after with a damp cloth using warm water.</p>
---	--	--	---

MIOCULTURE.COM

Still have questions?
Drop us a line or give us a call:



Email: info@mioculture.com
US Toll Free: 1-888-563-3916
International: +1(215) 925-9359

All trademarks, service marks and trade names (MIO, product names and the MIO logo) are owned and registered by MIO. All content including but not limited to text, designs, graphics, photos and all other content ("Content") is a collective work under the United States and other copyright laws and is the proprietary property of MIO. All rights reserved. ©2021 MIOIM LLC