



3645 North Peachtree Road, Atlanta, GA 30341

Phone: 770.458.5900

Fax: 770.458.0892

Email: info@linerfactory.com

Website: www.linerfactory.com

VINYL LINER ORDER FORM

Name _____ Date _____

Billing Address _____

City _____ State _____ Zip _____

Phone _____ - _____ - _____ Alternate Phone _____ - _____ - _____

Email: _____

SHIP TO: Name _____ Phone _____ - _____ - _____

Address _____

City _____ State _____ Zip _____

PAYMENT ARRANGEMENTS

Payment Type: Cash\$ _____ Check\$ _____ Credit\$ _____

Card Number _____ Exp _____ CVS Code _____

Billing Address if different than above _____

City _____ State _____ Zip _____

TYPE LINER: STANDARD BEAD OVERLAP _____ inches OTHER _____

WALL PATTERN _____ ROMAN END SHALLOW ROMAN END DEEP

FLOOR PATTERN _____ SEPARATE DRAWING SUBMITTED WITH THIS ORDER

Include a separate drawing for pools with steps, roman ends, special shaped pools such as kidney, figure 8 and all custom shape pools (with A & B dimensions) SPECIAL INSTRUCTIONS _____

DIMENSIONS: (measure from bead receptor to finished bottom)

A	D	E	F	G	L	W
B	H	I	H	H ₁	H ₁	X
C	C ₁	N	O	P	K	M
J	A ₁	A ₂	A ₃	A ₄	B ₁	B ₂
Z ₁	Z ₂	Z ₃	Z ₄	R	Q	S

CORNERS:

SQUARE _____

RADIUS _____

DIAGONAL _____

Is the pool square?

VINYL STEP DETAIL

STEP WIDTH _____ LENGTH _____

Tread/Riser Detail

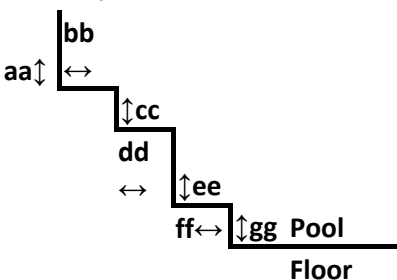

aa	
bb	
cc	
dd	
ee	
ff	
gg	
hh	
ii	
jj	
kk	

BOTTOM STEP

Recessed Flush

NO. Inches _____

TOP STEP CORNER

Radius _____" Square

Center Step

Side Step

Offset from Corner _____

ROMAN END DETAIL

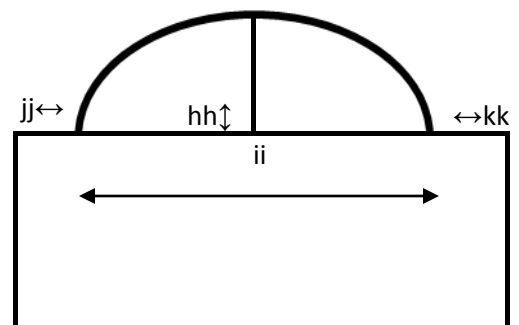

SPARTAN™ POOL LINERS

Name _____

Phone _____

POOL SHAPE—please indicate which is the shape of your pool.

RECTANGLE

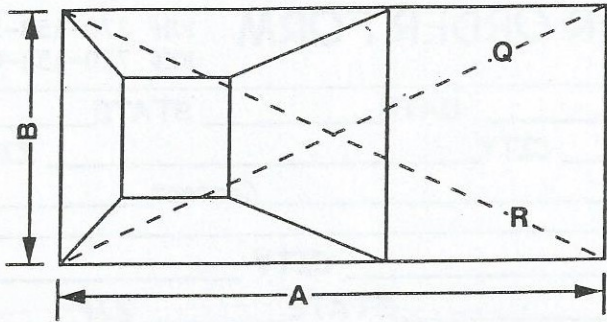

OVAL

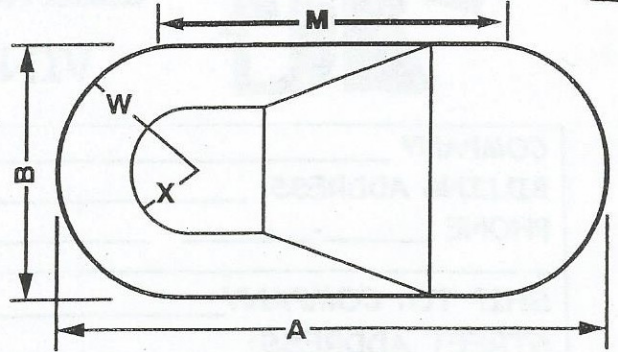

CONTOUR BOTTOM GRECIAN

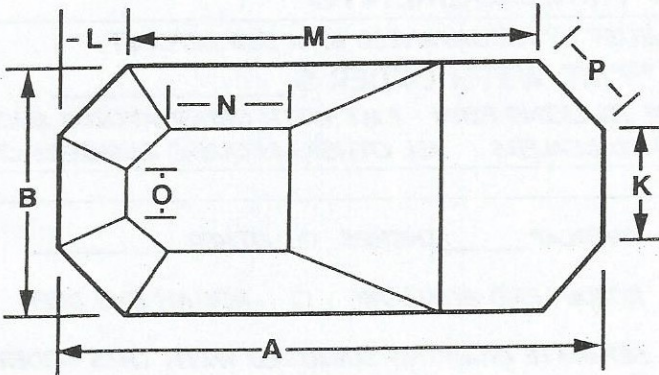

SQUARE BOTTOM GRECIAN

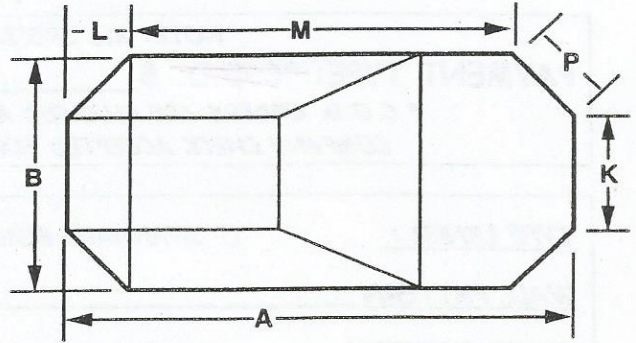

LAZY "L" Right **Left (shown)**

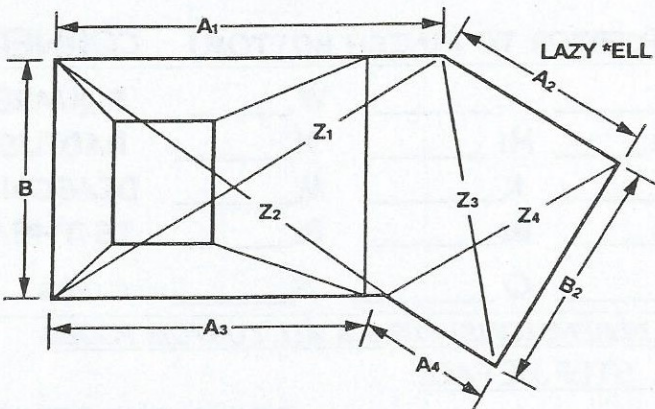

TRUE "L" Right **Left (shown)**

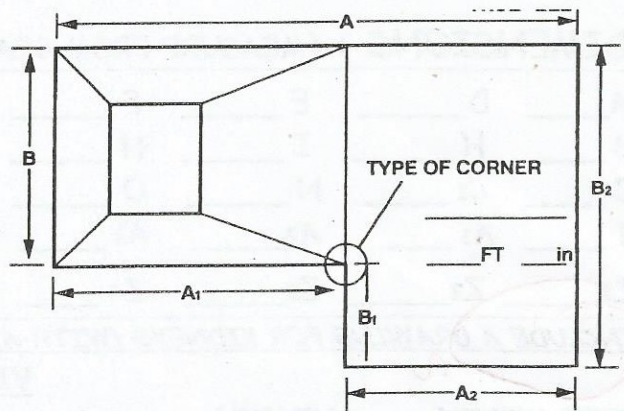

Bottom Contour

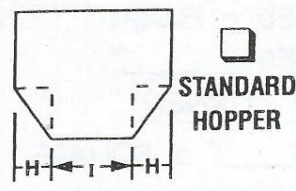
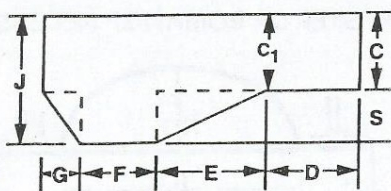

STANDARD HOPPER

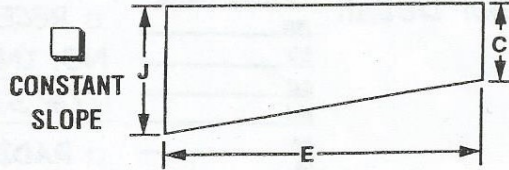

CONSTANT SLOPE

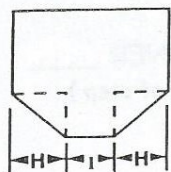
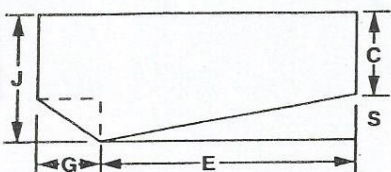

WEDGE

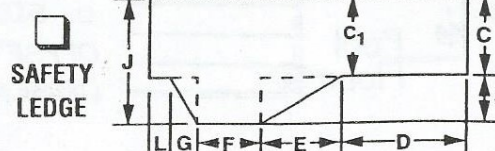

SAFETY LEDGE

