

USE & CARE INSTRUCTIONS

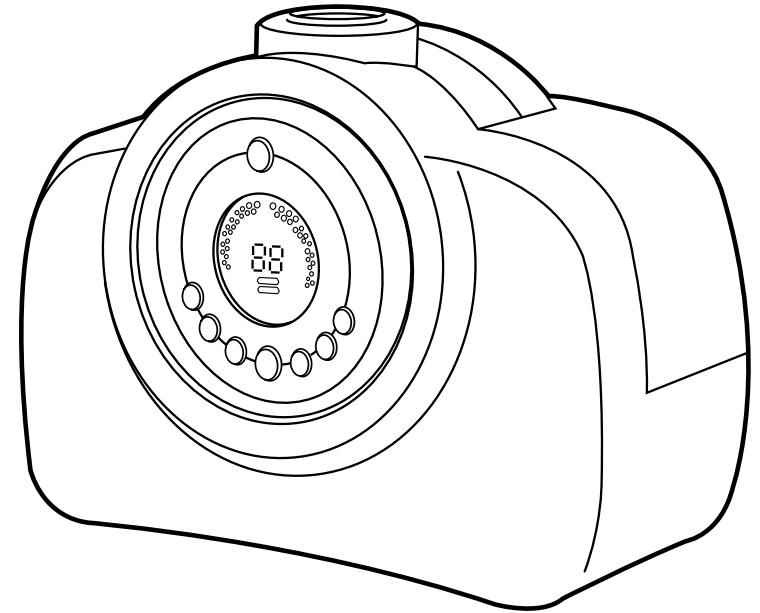

pureguardian™ Ultrasonic Digital Humidifier

Guardian Technologies LLC
7700 St Clair Avenue | Mentor, Ohio 44060
1.866.603.5900 | www.guardiantechnologies.com

Model No. H3000
3-Year Limited Warranty
www.guardiantechnologies.com
1.866.603.5900

REV0411

English E - 1
French F - 1
Spanish S - 1

Date Purchased
month _____
year _____

READ AND SAVE THESE INSTRUCTIONS PRODUCT SPECIFICATIONS AND PARTS

SPECIFICATIONS

Model Number: H3000
Humidifying Mode: Combination
Power Supply: AC120V, 60Hz
Power Consumption: 140W (40W at cool humidification)
Humidity Capacity: About 350 cc/hr. (at highest setting and warm humidification)
Tank Capacity: 1.4 gallons
Successive Humidity Hours: Up to approximately 72-hours depending on environmental conditions

Humidity Range: 25-80%
Dimensions: Width 14.5 inches - Height 12 inches - Depth 9 inches
Weight: 8.8 pounds (not including packaging)

PARTS

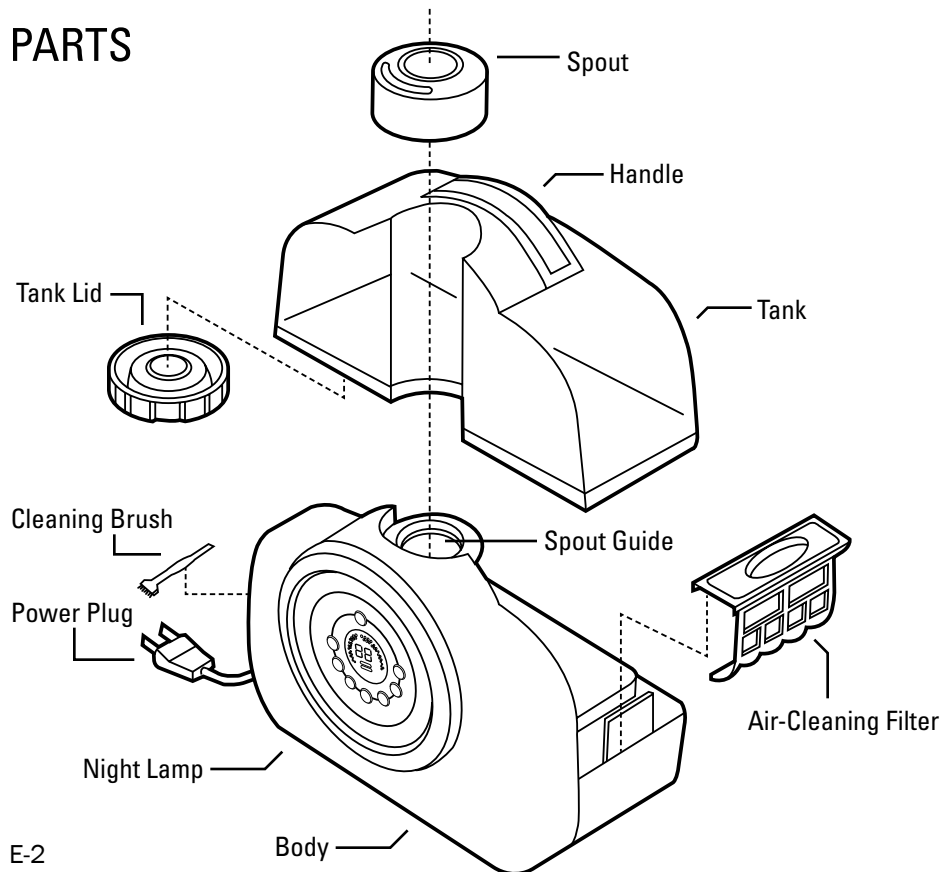

READ AND SAVE THESE INSTRUCTIONS PRODUCT SPECIFICATIONS AND PARTS (cont.)

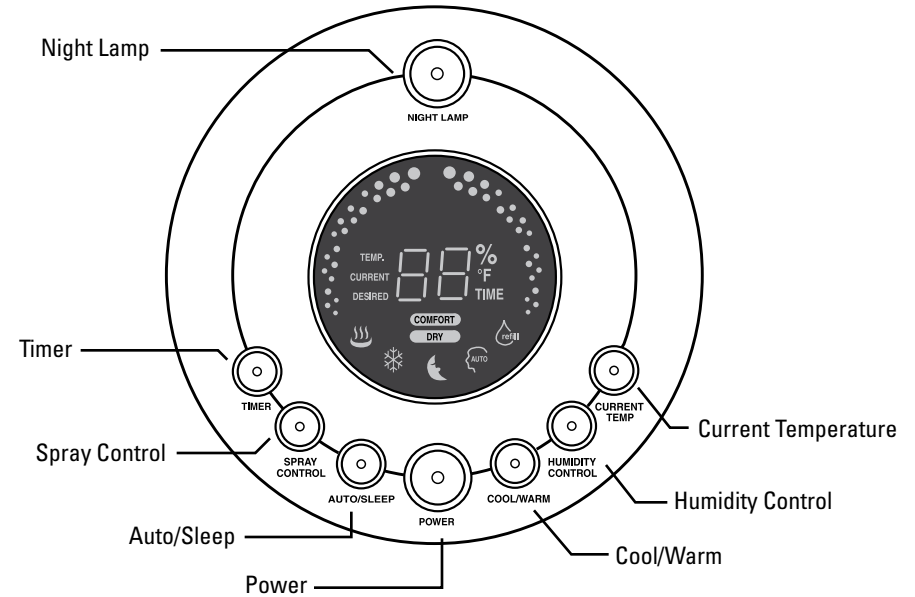

FUNCTIONS AND FEATURES

Warm or Cool Humidification Selection

Select humidifying temperature based on need. Warm humidity will use more power but will humidify your room quicker.

Spray Control

The mist level may be adjusted to low, medium, high and turbo.

Timer

Allows you to select the number of hours you want the unit to run.

Humidity Level

40-55% humidity is considered within the comfortable range.

Water Shortage Indicator

When the unit is low on water the Refill LED on the front panel will light up, and the unit will shut off. Simply add more water to continue use.

Humidity Adjustment

The humidity volume may be adjusted based on need by pressing the humidity control button on the front panel.

Night Lamp

Provides soft light with ON/OFF switch.

READ AND SAVE THESE INSTRUCTIONS

WARNINGS



This product should be used only in accordance with the specifications outlined in this manual. Usage other than what has been specified here may result in serious injury.

WARNING: THE CORDS, WIRES AND/OR CABLES SUPPLIED WITH THIS PRODUCT CONTAIN CHEMICALS, INCLUDING LEAD OR LEAD COMPOUNDS, KNOWN TO THE STATE OF CALIFORNIA TO CAUSE CANCER AND BIRTH DEFECTS OR OTHER REPRODUCTIVE HARM, WASH HANDS AFTER USING.

- Disassembly, repair or remodeling by an unauthorized person may result in serious harm.
- Do not use if plug is damaged or loose.
- Keep this product out of the reach of children and away from pets.
- Be careful not to put water in the humidity spout.
- Before filling or cleaning the unit, make sure it is unplugged.
- Once the humidifier has been turned on, do not move it and do not disassemble the water tank.
- Do not move when in operation.
- Do not remove the water tank from the unit while it is on.
- Do not handle the adapter plug with wet hands.
- Do not excessively bend, twist or pull the power cable.
- Avoid placing this product where the humidity is pointed directly at an electrical object.
- Do not directly inhale the humidity.
- Do not place this product on a sloped or unstable surface.
- When not in use, unplug the unit.
- Do not fill the water tank with hot or boiling water.
- Do not use this product in direct sunlight, or near a gas stove or heater.
- If the water tank becomes cracked or damaged, do not use.
- Do not keep this product running for an extended period of time.
- Do not clean the unit or water tank with detergents or chemicals of any kind.
- Do not use this product near any other electronic device.
- Do not cover the humidity opening at any time during use.
- Do not use this product near a sink.
- Do not drink water from the water tank.
- Do not place this product on an absorbent surface (ie carpet, towel, blanket, etc).
- Do not pour anything but water into the water tank.
- Children cannot recognize the hazards associated with the usage of electrical appliances. For this reason, always supervise children when they are near the humidifier.
- If the mist comes in contact with the floor prior to evaporating, the floor surface may be damaged. We do not accept any liability for damage in the case of the unit being placed incorrectly.
- The use of water additives, such as ethereal/essential oils, fragrances, eucalyptus, water conditioners, etc will damage the appliance materials and as a consequences the whole unit. Any use of such additives will void the manufacturer's warranty.
- **IMPORTANT:** Neither humans nor animals can hear the high frequency vibrations.

Failure to comply with the warnings listed above may result in electric shock or serious injury.

WARNING: DO NOT BLOCK ANY AIR VENTS LOCATED ON BOTTOM AND/OR SIDE OF UNIT.

DIRECTIONS FOR USE

Make sure the unit is unplugged.

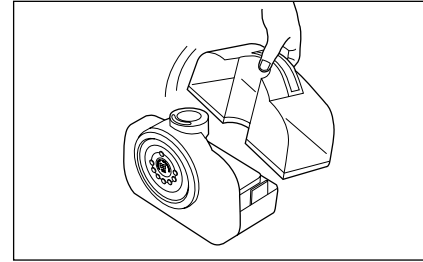

1. Separate the tank from the body of the unit.

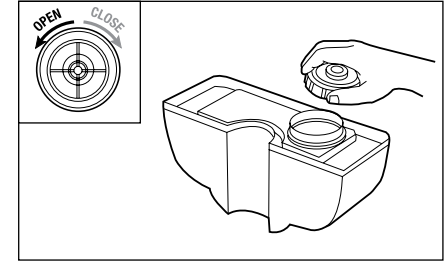

2. Open the tank lid, turning it to the left.

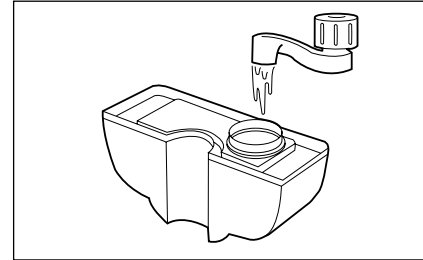

3. Pour cool, clean water directly into the tank. Do not pour anything but water into the water tank.

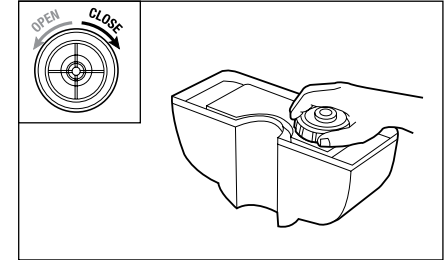

4. Close the tank lid, turning it to the right.

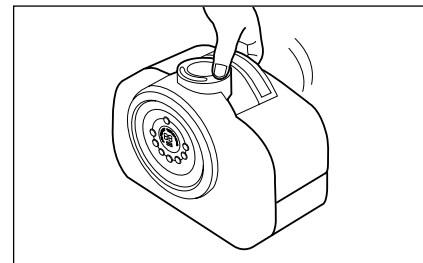

5. Attach the tank to the body of the unit.

DIRECTIONS FOR USE - OPERATING INSTRUCTIONS

(cont.)

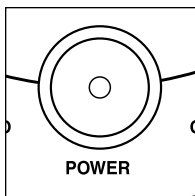

6. Power Button

Before turning on make sure there is water in the unit. Press the Power Button. The unit will display the current humidity in the room. Once the unit is turned on it may take a short time for the humidity reading to stabilize.

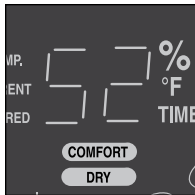

7. The current humidity level in the room will be shown on the display. The humidity reading will not display below 25%.

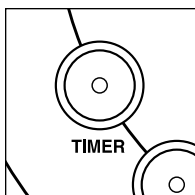

8. Timer Button

Press the Timer Button and set the number of hours you would like your Ultrasonic Humidifier to run (1-hour, 2-hours, up to 12 hours).

- If you press the button during operation the remaining time is displayed.
 - Press it again to adjust the time.
- (Co- means Constant Humidification)

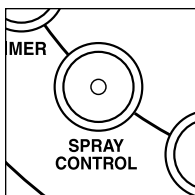

9. Spray Control Button

When you press the Spray Control Button there are four options to choose from:

- Press once for **WEAK**
- Press twice for **MIDDLE**
- Press three times for **STRONG**
- Press four times for **TURBO**



*You will notice the lights get higher as the spray increases.

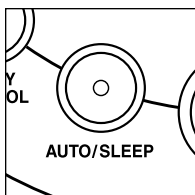

10. Auto

Press once for auto. This will keep the unit running continuously with warm humidification. When selected this setting will automatically work to maintain the humidity in the room at a comfortable level. During this mode the unit operates at a warm temperature and may shut off when it reaches optimal humidity. It will restart again as the humidity level begins to decrease.

11. Sleep

Press twice to activate sleep mode. In this mode the unit will run at warm humidification for 3 hours then shut off. When selected this will also turn on the moon (sleep indicator) and turn off all other display lights.

DIRECTIONS FOR USE - OPERATING INSTRUCTIONS

(cont.)

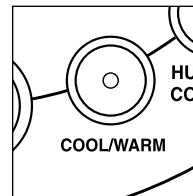

12. Cool/Warm Button

Press to select cool or warm humidification. Water temperature is maintained at 40 degrees for cool and 80 degrees for warm. Warm vs. cool mist is a matter of personal preference; warm will humidify room quicker.

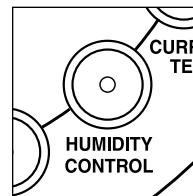

13. Humidity Control Button

Press the Humidity Control Button to change the humidity level.

Humidity level options:

30%, 35%, 40%, 45%, 50%, 55%, 60%, 65%, 70%, 75%, 80%.

Five seconds after pressing this button the current humidity level will be displayed.

This will not affect the spray output.
Co - means Constant Humidification



14. Water Refill Button

When the Water Refill Button lights up it is time to refill the water tank.

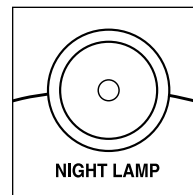

15. Night Lamp Button

Press the Night Lamp Button at the top of the unit to illuminate the night light feature.

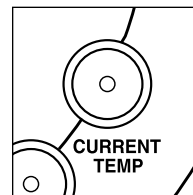

16. Current Temperature Button

Press to display the current temperature in your room.

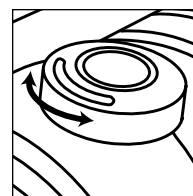

17. Turn spout to select preferred direction of humidity spray.

MAINTENANCE

- Always unplug the unit before servicing it in any way.
- Be careful when handling the water if warm humidification was selected. The water temperature of the water remaining in the unit after use may be high.
- Do not submerge the unit in water, or allow water to enter anywhere on the unit except the designated water tank.

INSIDE THE BODY OF THE UNIT

Wash out the unit with fresh water, using the cleaning brush and a soft cloth.

Ultrasonic Metal Circle:

Humidity levels become weak when water spots remain on the surface of the ultrasonic metal circle.

Do not use chemicals or detergents.

OUTER SURFACE OF THE UNIT

Wipe the surface of the unit with a damp cloth if needed. Do not use any type of cleaning chemical as it may corrode the surface.

WATER TANK

If water spots remain in the water tank, wipe the inside with a soft cloth. Do not use soap or detergents. Silver Clean particles have been added to the water tank to help fight the growth of mold, mildew and bacteria.

AIR FILTER

Gently wipe away debris from the filter with a soft cloth.

ULTRASONIC DISK

Remove spray spout (Fig. 1) and use the enclosed cleaning brush to regularly remove build up and deposits from this area (Fig. 2). White vinegar will help to prevent this build up.

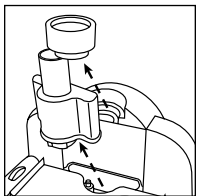

Fig. 1

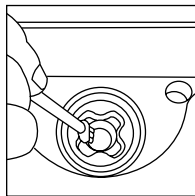

Fig. 2

STORAGE

- Fully dry the inside and outside of the unit before storing it.
- DO NOT leave water in the unit.
- Store in a cool, dry place.

TROUBLESHOOTING GUIDE

PROBLEM	SOLUTION
Water vapor & humidity are not produced.	Power Plug: Unplug and then try again. Power Failure: When the power is returned, try again. Tank Installation: Make sure the water tank is correctly attached.
Air blows but water vapor is not produced.	Excessive Water: Remove a certain amount of water from the tank. The desired humidity is lower than the current temperature: Increase the desired humidity. Detergent residue in the tank: Wash the tank out and try again.
Humidity level is low.	The surface of the ultrasonic metal circle may be dirty: Wipe it off with a dry, soft cloth. The water in the unit is too cold: Replace with cool, but not cold water. Damage on the ultrasonic metal circle: Contact customer service at 1.866.603.5900.
Warm humidity is not produced.	It may take 10-15 minutes before warm humidity is created. The steam may not feel warm to the touch.
The humidity has a bad smell.	Poor maintenance or dirty water: Clean the product thoroughly, and fill it with fresh water.
White dust is forming on nearby furniture.	Hard water will deposit a certain amount of dust. Dust in the air settles because of the added humidity in the room. Use distilled water if this becomes a nuisance.
My current humidity will not go below 25%.	The unit will not display a humidity setting below 25%. This means the current humidity in your room is at or below 25%.

LIMITED WARRANTY

To the consumer, Guardian Technologies LLC warrants this product to be free of defects in materials or workmanship commencing upon the date of the original purchase. Save your original sales receipt to validate start of the warranty period.

If this product should become defective within the warranty period, we will repair or replace any defective parts free of charge. The complete machine must be delivered pre-paid to any authorized Guardian Technologies LLC warranty service center. Please include complete information on the problem, date of purchase, copy of original sales receipt and your name, address and telephone number. If you are not near a warranty center, call the factory for assistance in the US and Canada at 1.866.603.5900. Use only genuine Guardian Technologies replacement parts.

The warranty does not include unusual wear, damage resulting from accident or unreasonable use of the product. This warranty does not cover unauthorized repairs. This warranty gives you specific legal rights and you may also have other rights (other rights may vary from state to state in the U.S.A.).

We consider the registration process important to ensuring superior service to our customers, however submitting the warranty card to Guardian Technologies LLC is optional and does not affect your rights to utilize this warranty according to the conditions stated above. If you have any questions or comments about our product call toll free at 1.866.603.5900 or send comments to:

**ATTN Customer Service
Guardian Technologies LLC
7700 St Clair Avenue
Mentor, Ohio 44060**

This warranty can also be registered online at www.guardiantechnologies.com.



This product has been tested and complies with the requirements for Federal Communications Commission, Part 18 for Radio/TV/Communication interference. Although tested, it may affect these devices. If the humidifier is found to interfere, separate the device and/or the humidifier. Conduct only the user maintenance found in this manual. Other maintenance and servicing can cause harmful interference and can void the required FCC compliance.

Guardian Technologies LLC
7700 St Clair Avenue | Mentor, Ohio 44060
1.866.603.5900 | www.guardiantechnologies.com