

ALL MATERIALS TYPE 316 STAINLESS STEEL ALLOY EXCEPT FOR FASTENERS.  
THIS KIT IS DESIGNED FOR A BRICK, BLOCK, OR PRECAST WALL ONLY

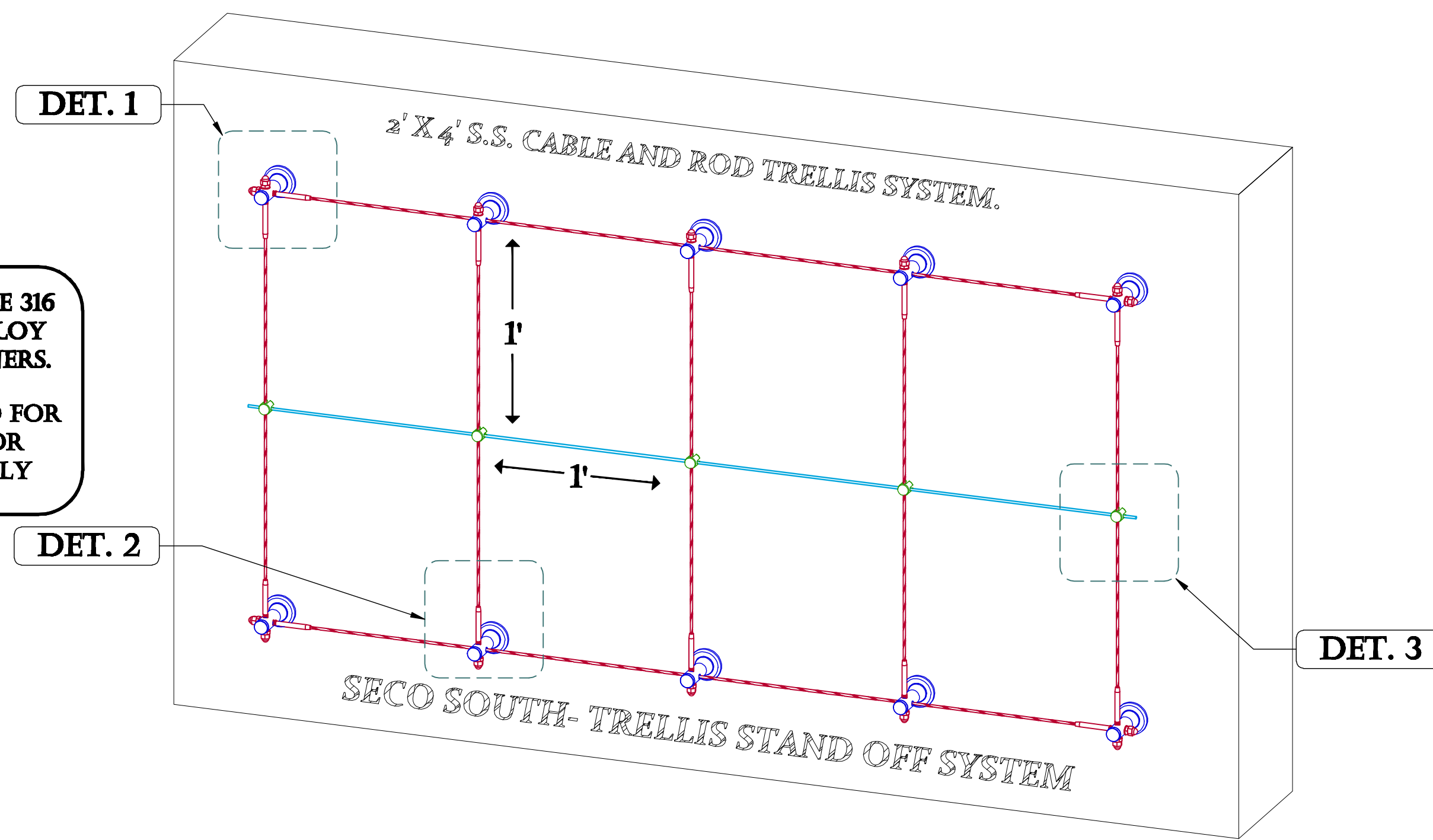

**2' X 4' TRELLIS, 1' GRID**

SCALE: 2" = 1'

TYPICAL CORNER ATTACHMENT.

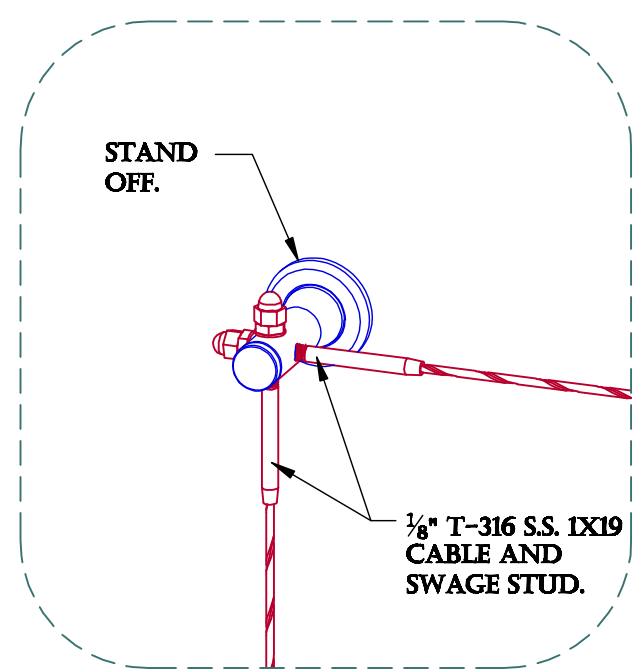

**MOUNTING DETAIL 1.**

SCALE: 4" = 1'

TYPICAL END/ INTERMEDIATE ATTACHMENT.

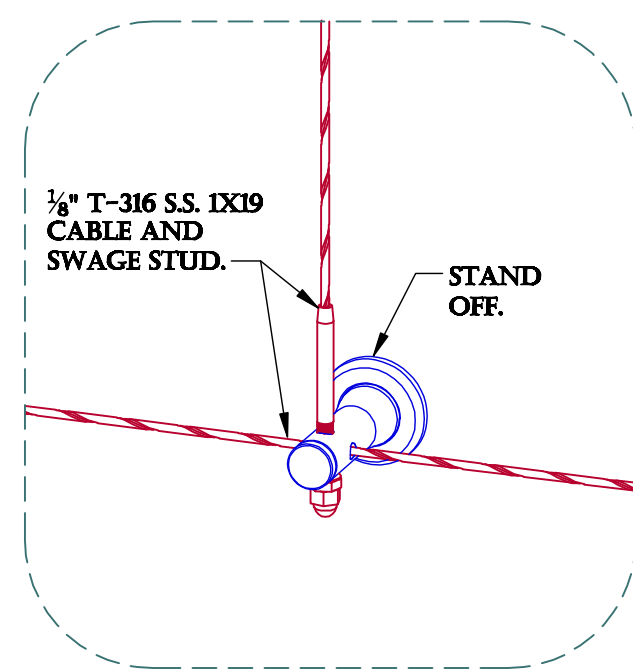

**MOUNTING DETAIL 2.**

SCALE: 4" = 1'

TYPICAL CABLE AND ROD INTERSECTION ATTACHMENT.

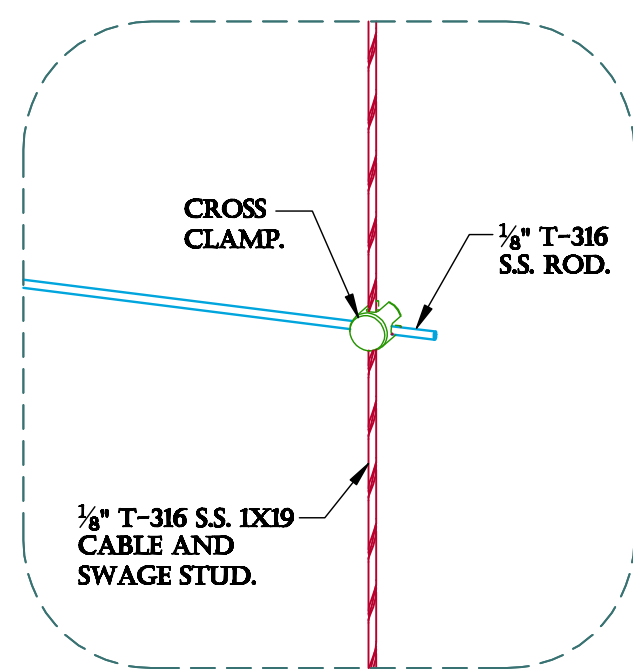

**MOUNTING DETAIL 3.**

SCALE: 4" = 1'

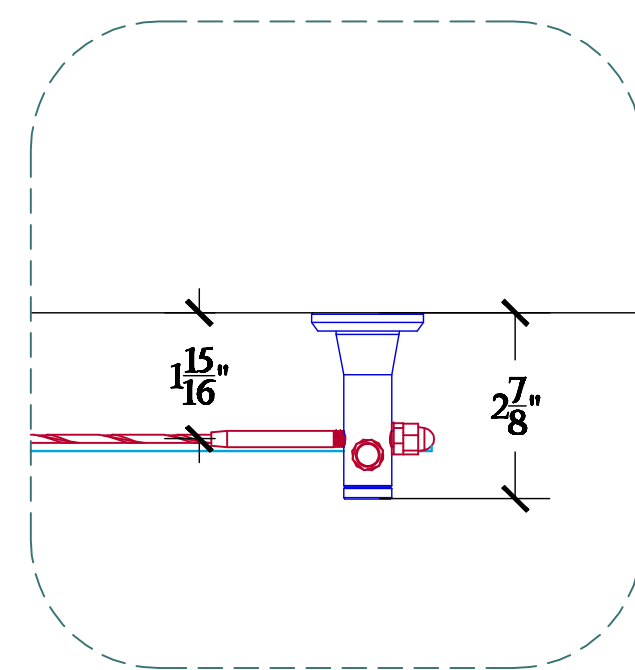

**TOP VIEW DETAIL.**

SCALE: 4" = 1'

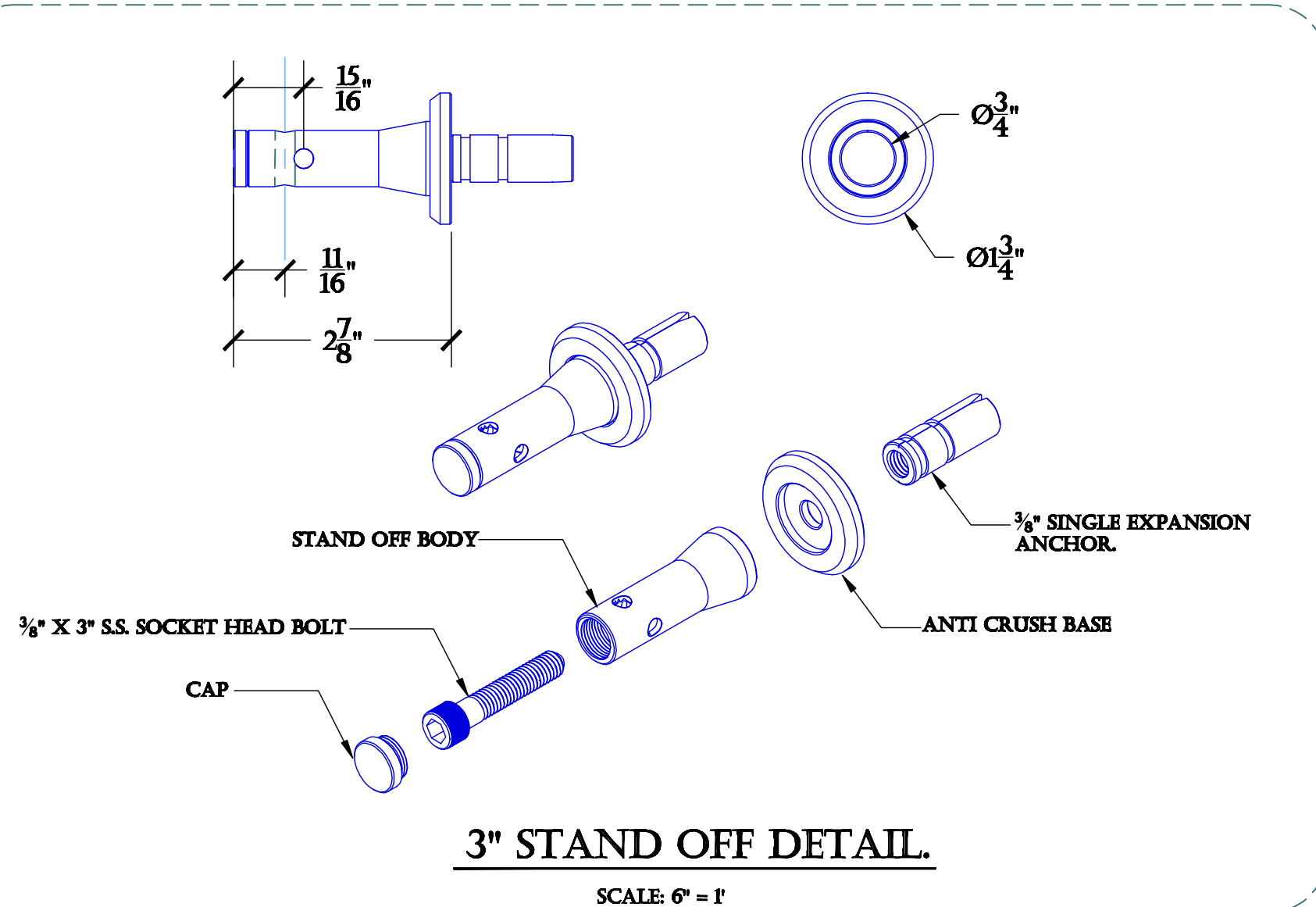

**3" STAND OFF DETAIL.**

SCALE: 6" = 1'

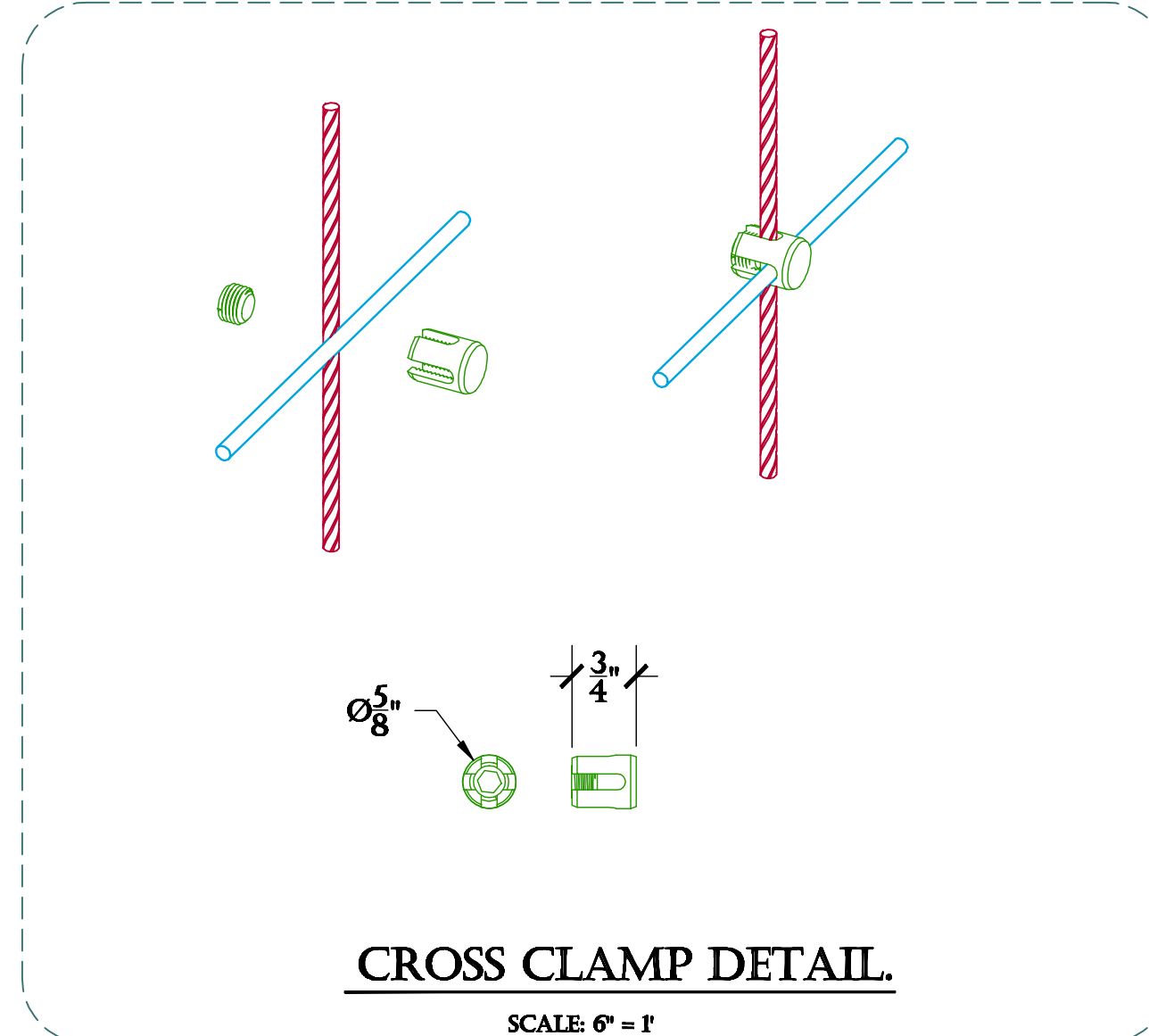

**CROSS CLAMP DETAIL.**

SCALE: 6" = 1'

**THE 2' X 4' KIT INCLUDES THE FOLLOWING:**

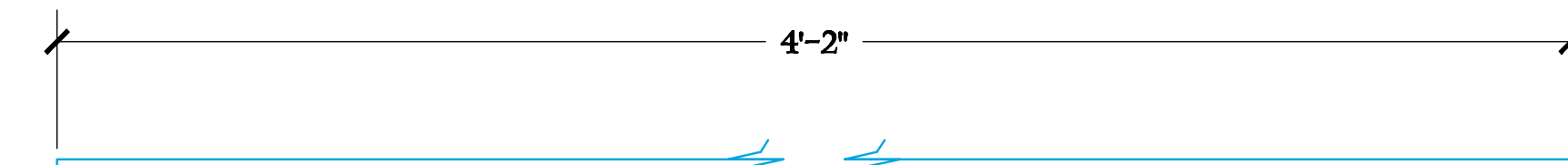

Ø1/8" T-316 S.S. ROD : QTY- 1

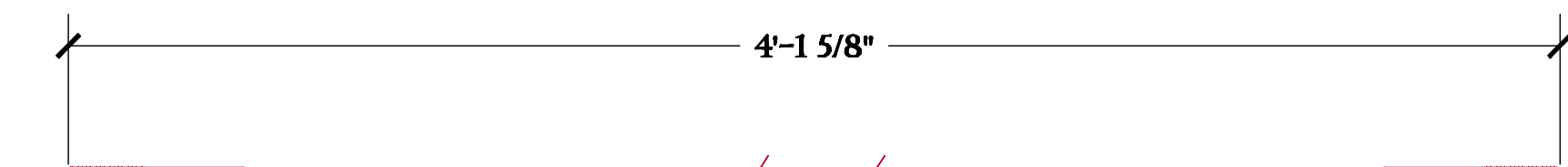

Ø1/8" LONG CABLE W/ SWAGE STUDS : QTY- 2

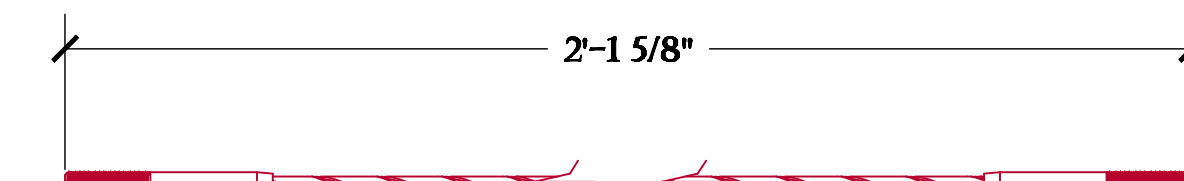

Ø1/8" SHORT CABLE W/ SWAGE STUDS : QTY- 5

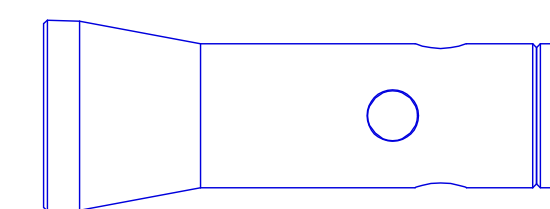

3" STAND OFF BODIES : QTY- 10

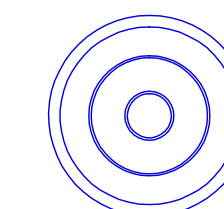

ANTI CRUSH BASE : QTY- 10



3/8" X 3" S.S. SOCKET HEAD SCREW : QTY- 10

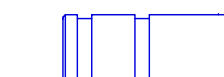

SINGLE EXPANSION ANCHORS : QTY- 10

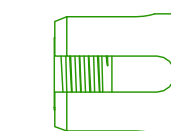

S.S. CROSS CLAMPS : QTY- 5



S.S. CAP NUTS : QTY- 14



S.S. JAM NUTS : QTY- 14



S.S. FLAT WASHERS : QTY- 14

PRODUCT: S.S. CABLE AND ROD TRELLIS STAND OFF SYSTEM.  
CONTENT: "STAND OFF" 2'X4' STANDARD SYSTEM DETAILS.  
DRAWN BY: KELLER, C.  
DATE 10-01-15  
PROPRIETARY AND CONFIDENTIAL: THE INFORMATION CONTAINED IN THIS DRAWING IS THE SOLE PROPERTY OF SECO SOUTH INC. ANY REPRODUCTION IN PART OR AS A WHOLE WITHOUT THE WRITTEN PERMISSION OF SECO SOUTH INC. IS PROHIBITED.  
2111 34TH WAY  
LARGO, FL 33771  
TEL: 727-536-1924  
FAX: 727-539-6314  
SALES@SECOOUTH.COM

