

ALL MATERIALS TYPE 316 STAINLESS STEEL ALLOY .
THIS KIT IS DESIGNED FOR A BRICK, BLOCK, PRECAST, OR WOOD WALL.

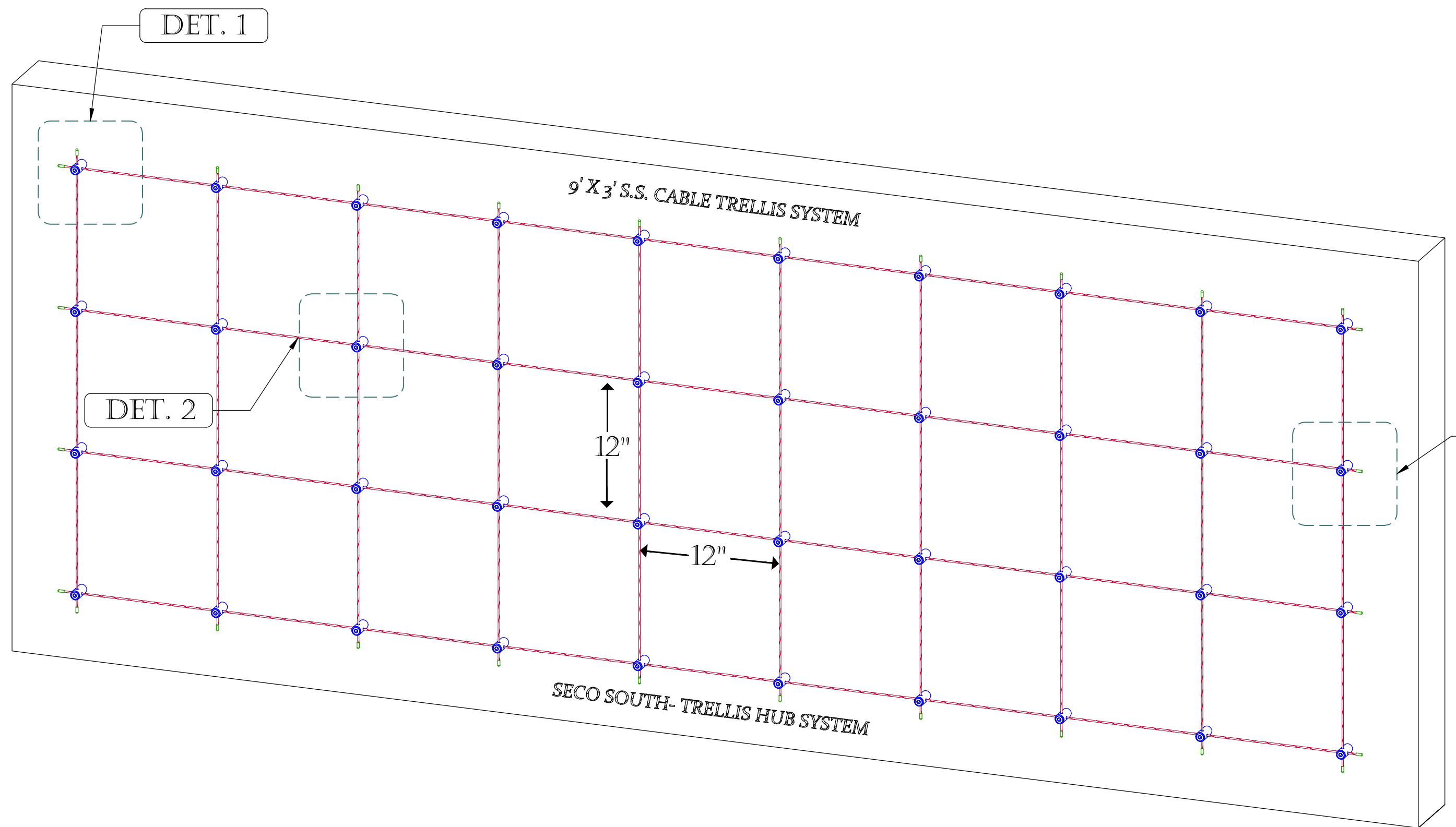

9' X 3' TRELLIS, 12" GRID.
SCALE: 1 1/2" = 1'

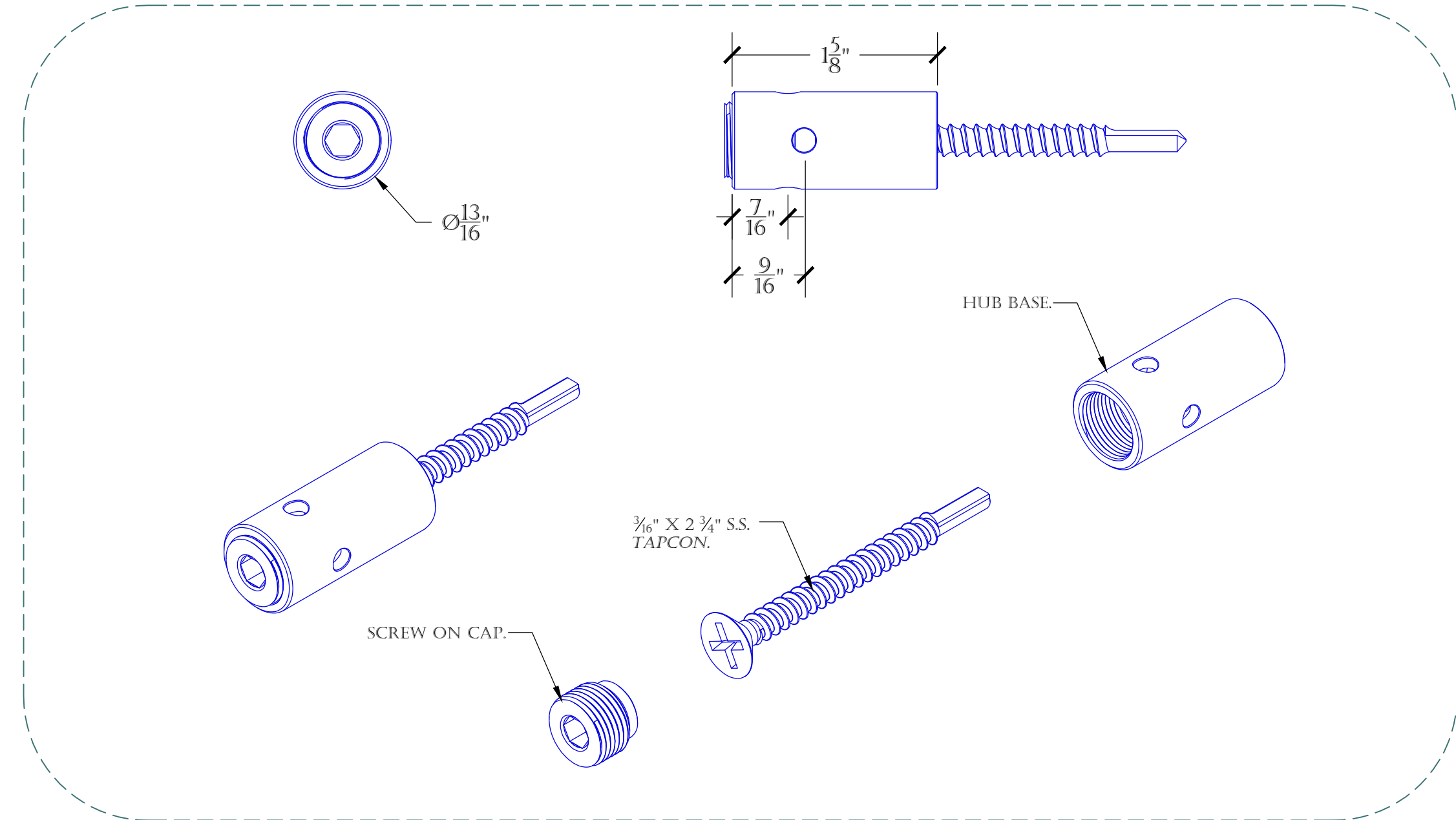

HUB DETAIL.
SCALE: 1" = 1'

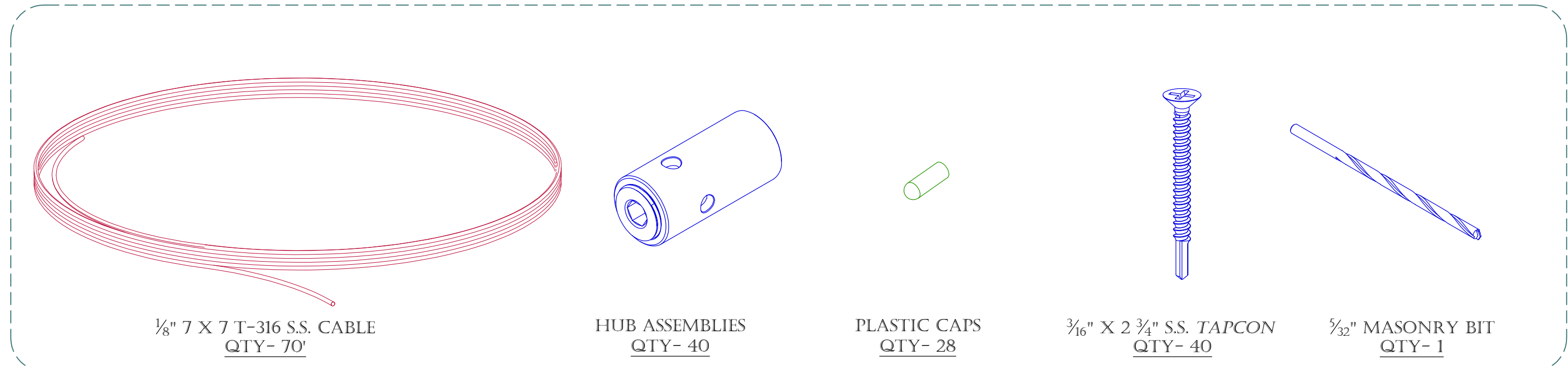

THE 9' X 3', 12" GRID KIT INCLUDES THE FOLLOWING:

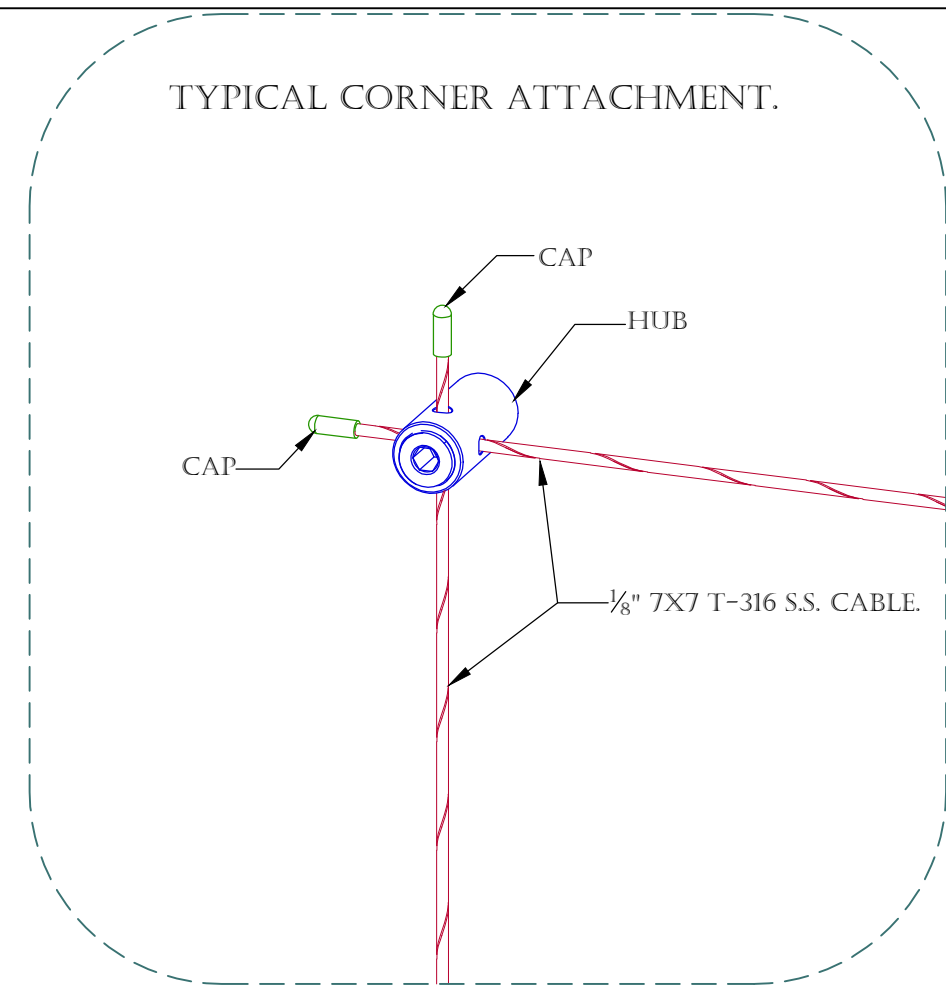

TYPICAL CORNER ATTACHMENT.
MOUNTING DETAIL 1.
SCALE: 6" = 1'

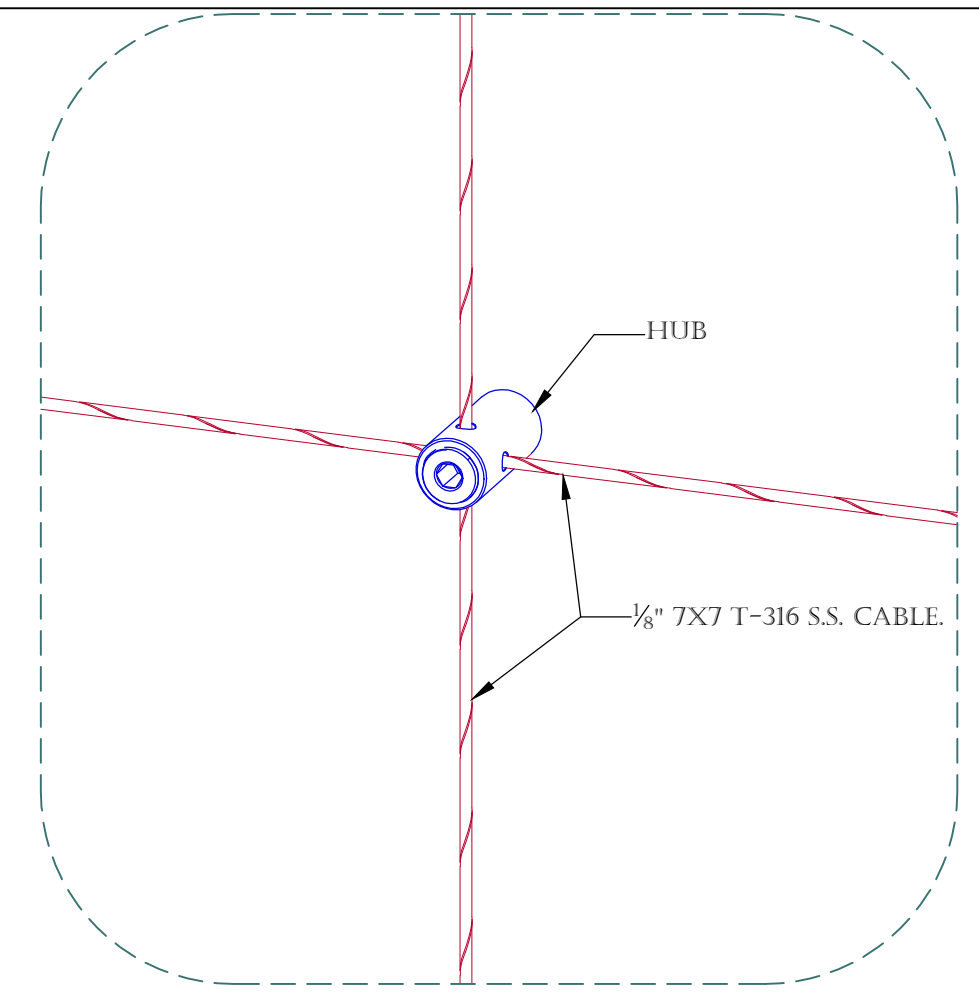

TYPICAL END/ INTERMEDIATE ATTACHMENT.
MOUNTING DETAIL 2.
SCALE: 6" = 1'

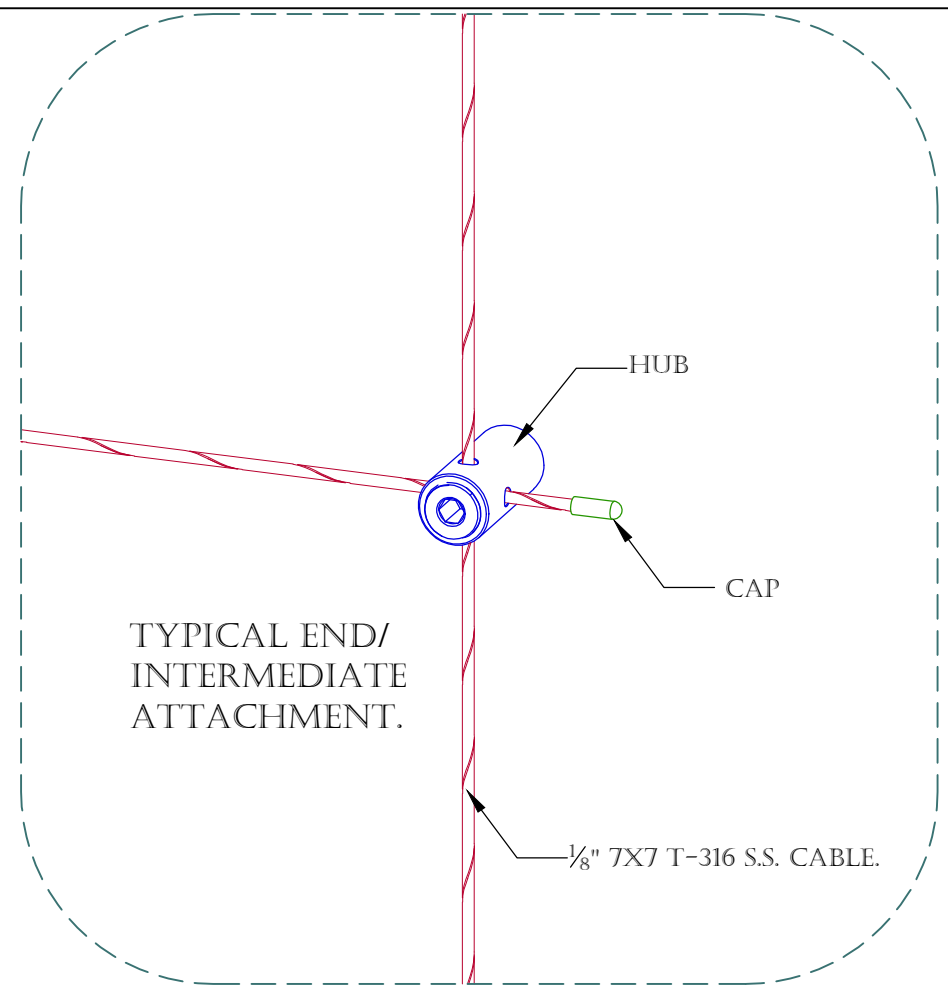

TYPICAL END/ INTERMEDIATE ATTACHMENT.
MOUNTING DETAIL 3.
SCALE: 6" = 1'

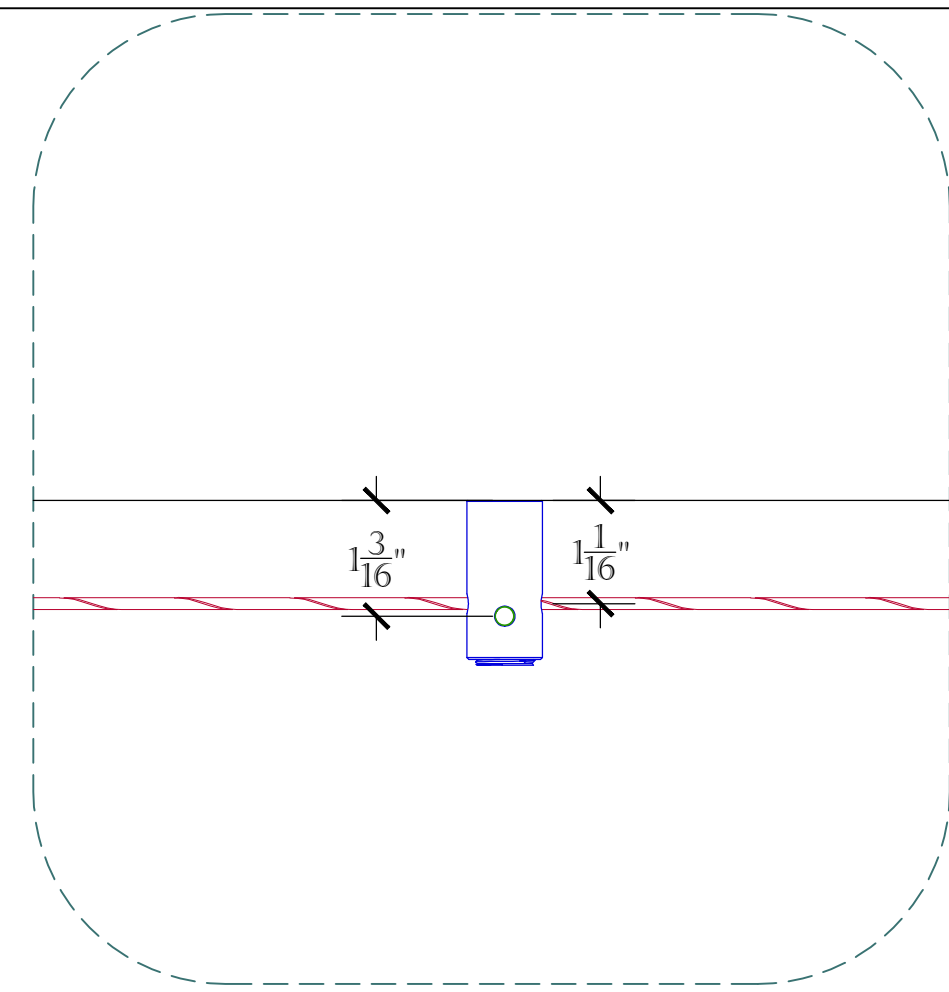

TOP VIEW DETAIL.
SCALE: 6" = 1'

PRODUCT: S.S. CABLE GREEN WALL/ HUB TRELLIS SYSTEM.		2111 34TH WAY LARGO, FL 33771 PH: 727-536-1924 FAX: 727-539-6314 SALES@SECOOUTH.COM	
CONTENT: 9' X 3' , 12" GRID STANDARD SYSTEM DETAILS.			
DRAWN BY: KELLER, C.			
DATE: 10-01-15	REV: 9-11-20		
<small> PROPRIETARY AND CONFIDENTIAL. THE INFORMATION CONTAINED IN THIS DRAWING IS THE SOLE PROPERTY OF SECO SOUTH INC. ANY REPRODUCTION IN PART OR AS A WHOLE WITHOUT THE WRITTEN PERMISSION OF SECO SOUTH INC. IS PROHIBITED. </small>			