

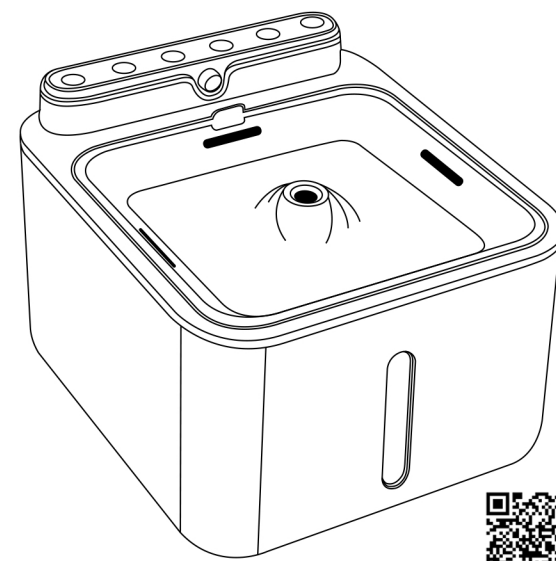

3.2L Rechargeable Pet Water Fountain User Manual



Maintenance & Troubleshooting

Reach to us via support@sgsmartpaw.com

Please read the manual carefully before use and keep it for future reference.

FEATURES

- 3.2L high capacity
- 3 modes: IR sensor mode, timer mode, and standard mode
- 4000mAh backup battery
- 2 power options: by battery or by plug-in
- Lack water reminder(red light on) & protection(auto shut-off pump)
- Filter replacement indicator
- Stainless steel water dish
- Ultra-silent pump

SPECIFICATION

Tank Capacity	3.2L
Battery Capacity	4000mAh
Material	ABS+304 Stainless Steel
Filter	Activated Carbon
Size	7.9" x 7.1" x 5.6"
Input	DC5V 2A
Rated Power	0.3W

ATTENTION

- To ensure safe and correct use, please read the following notes carefully.
- Please follow the installation and operation instructions while using.
 - Please use this pet fountain on a stable ground against the wall indoors.
 - Please keep it away from fire source and sunlight.
 - Only the stainless steel water dish is dish washer safe, other parts are not.
 - The water tank cover, inside which the battery is located, is strictly prohibited from being washed with water(Dry wipe only).
 - Use DC 5V 2A power adapter for DC power supply (power adapter not included).

01

WHAT'S IN THE BOX

After unpacking, please check whether all components are complete.

1. Water Dish

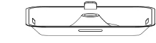

2. Water Tank Cover



3. Filter



4. Water Tank



5. Power Cable

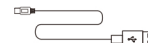

6. Cleaning Brush



SCHEMATIC DIAGRAM

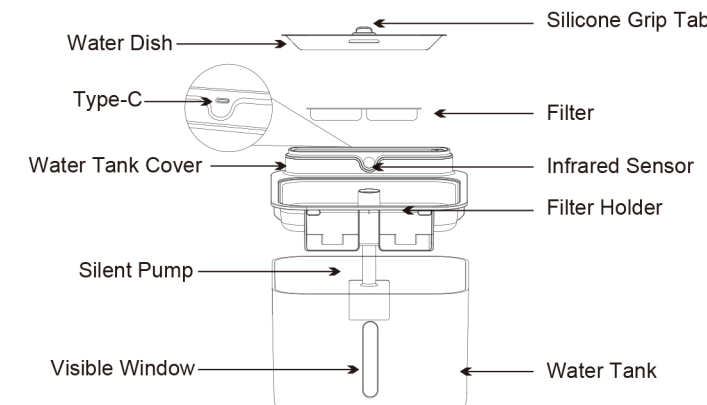

02

INSTALLATION

Please follow the steps below for the first use.

1. Before use, please clean the filter under rinsing water.
Note: The filter cannot be contaminated by oil.



2. Clean the water dish, and water tank under rinsing water.
Notes: Only the stainless steel water dish is dish-washer safe, all other parts are not.

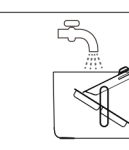

The water tank cover, inside which the battery is located, is strictly prohibited from being washed with water(Dry wipe only).

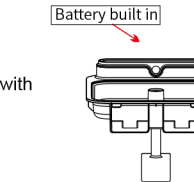

3. Add clean drinking water into the tank(no more than 3.2L)

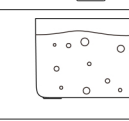

4. Seat the water tank cover on the water tank.

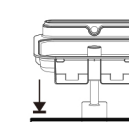

5. Put the filter into the slot on the water tank cover, and well position it.

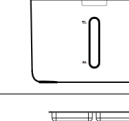

03

6. Load the water dish over the tank cover.

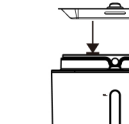

7. Place the fountain on a stable ground against the wall, power on and it starts to work.

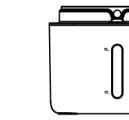

DUAL POWER SUPPLIES

Battery Power:
A 4000mAh large rechargeable battery built in. Charge it full and then use it for cordless purpose.

DC Power(Plug in):
Plug in and use. It will default to DC power priority, and will auto switch to battery power supply and sensor mode(IR sensing mode) in case of a power outage.

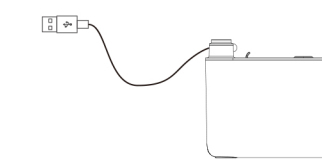

04

CONTROL PANEL

(Indicator Status + Set Button)

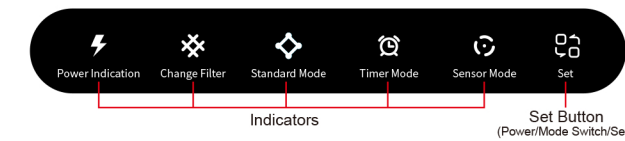

Icon Indicator Status & Introduction

Icon	Indicator	Status & Introduction
	Sensor Mode	1. Be on while a pet is detected. Water flow will start 1 or 2 seconds later and then continue flowing for 8 seconds. 2. Gradually flashes as a breathing light when no pet is detected. Sensing Distance: 1.5M Sensing Angle: 120°
	Timer Mode	1. Be on while working. 2. Slowly flash during the 5-min interval between every 1-min working period.
	Standard Mode	Be on while working.
	Change Filter	1. Be on(yellow light) if it reaches the filter's life cycle, reminding you of a change. 2. Flash twice and keep off after you reset the filter's life cycle to another 12-day countdown.
	Power Indication	1. When unplugged and driven by battery: Red light on when low battery level Light off when battery power is sufficient. 2. When plugged in: Blue light on when battery power is sufficient. Blue light flashes when battery power is in low level.

Set Button:

1. Power ON/OFF or Switch Work Mode:
Press once to power on, the fountain defaults to sensor mode. Press again and the sequence of it is timer mode, standard mode, and power off.

The indicator relevant to each work mode keeps on while working. The indicator of sensor mode gradually flashes as a breathing light when no pet is detected in sensor mode. The indicator of timer mode slowly flashes during each 5-min interval between every 1-min working period.

05

2. Reset Filter's Life Cycle After Filter Installation/Replacement:

1) For first time use
After filter installation is finished, please remember to long hold the set button for 5s till the yellow "Change Filter" indicator flashes twice and turns off so as to reset the filter's life cycle for a 12-day countdown.

2) For filter replacement next time
"Change Filter" indicator will turn on to remind you of a change. Every time when you complete filter replacement, please remember to long hold the set button for 5s till the yellow "Change Filter" indicator turns off to reset the filter's life cycle for another 12-day countdown.

OPERATION

(3 Working Modes)
1. This water fountain has 3 working mode options for your reference. All modes can work under DC power mode(plug in) or battery power mode(cordless use after charging).

2. This device defaults to DC power supply priority. When there is no DC power supply(or a power outage), it will automatically switch to battery power supply and sensor mode(IR sensing mode).

• Sensor Mode

When a pet enters the sensing area(sensing angle: 120° sensing distance: 1.5M), water supply will automatically start 1-2 seconds later(reaction time) and keep going for 8 seconds, the front light will turn on(BLUE) during working period; When the pet leaves the sensing area for 10 seconds, water supply will automatically stop and the front light will turn OFF. This mode is the default operating mode, press the set button to switch to the other 2 work modes.

• Timer Mode

In this work mode, the pet water fountain will supply water for 1 minute and stop for 5 minutes, and that cycle repeats. This work mode especially suits the need for caged pets.

• Standard Mode

The pet water fountain will always supply water after power on. Press the set button to switch mode.

06

LACK WATER PROTECTION & REMINDER

When there is a lack of water in the tank, light in the front will turn RED to remind you of low water level and time to refill, meanwhile, the pump will stop working to protect itself.

When there is enough water, light in the front keeps on blue as soon as the pump works(i.e. water flows) and turn off when pump stops working(i.e. water stops), no matter in which work mode.

ADDING WATER

Disconnect the power, add clean drinking water (maxi load: 3.2L).

CLEANING & MAINTENANCE

Please clean the whole water fountain including the pump every week.
1. Unplug first, then remove the top pieces from fountain, and wipe clean the water tank cover with a cloth, instead of rinsing water. Note: The water tank cover with battery inside is strictly prohibited from being washed with water.

2. Clean other parts with tap water.

Note: 1)The stainless steel water dish is dish-washer safe, all other parts are not.

2)When cleaning, please pay attention to the internal water pipes, corners and gaps, which are easily ignored.

3. Clean the pump(By way of this to extend the longevity of the pet water fountain).

- 1)Take down the pump from water tank cover
- 2)Take out the pump filter from pump and clean it if dirty.
- 3)Take down the pump filter holder
- 4)Remove the rotor cap
- 5)Pull out the rotor and insert brush into the middle hole of the rotor to deeply clean.
- 6)Clean the internal part of the pump and all other parts taken apart.

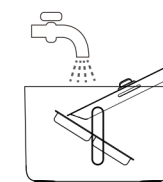

07

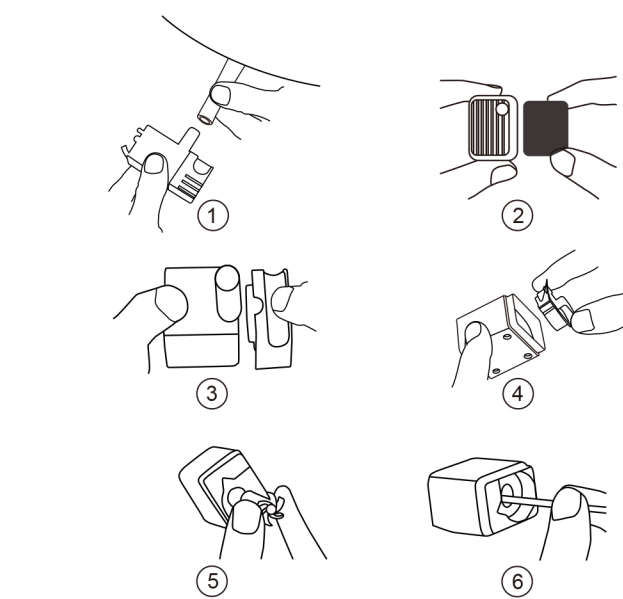

FILTER REPLACEMENT

1. For the health of your pet, please replace the filter once the "Change Filter" indicator turns on.
2. The usable time of original filter is about 12 days.

- Tips:
- ①The 12-day use time of original filter is based on our experiment, please judge the specific use time according to the actual use(The number of pets in a family, pets' behavior, etc).
 - ②To ensure safety and filtering effect, it is strongly recommended to use the original filter.
 - ③If water flow significantly slows down, the filter may be blocked by dirt, or it may be damaged, please replace the filter in time.
 - ④After the filter replacement is completed, press and hold the set button for 5s till the "Change Filter" indicator turns off to reset the filter life cycle for another 12 days' timing.

08

TROUBLE SHOOTING

Fault	Analysis	Troubleshooting
Pump not working	1. Power is disconnected 2. Battery is low power	1. Reconnect power 2. Replace the batteries
Less water flow	Pump is blocked	Clean the pump filter
Water overflows	Filter clogged	Replace the filter
Auto mode not working	IR sensor is stained	Wipe the sensor clean

Note: If the above faults cannot be resolved, please contact us in time.

CUSTOMER CARE

Reach to us via support@sgsmartpaw.com



09

10