

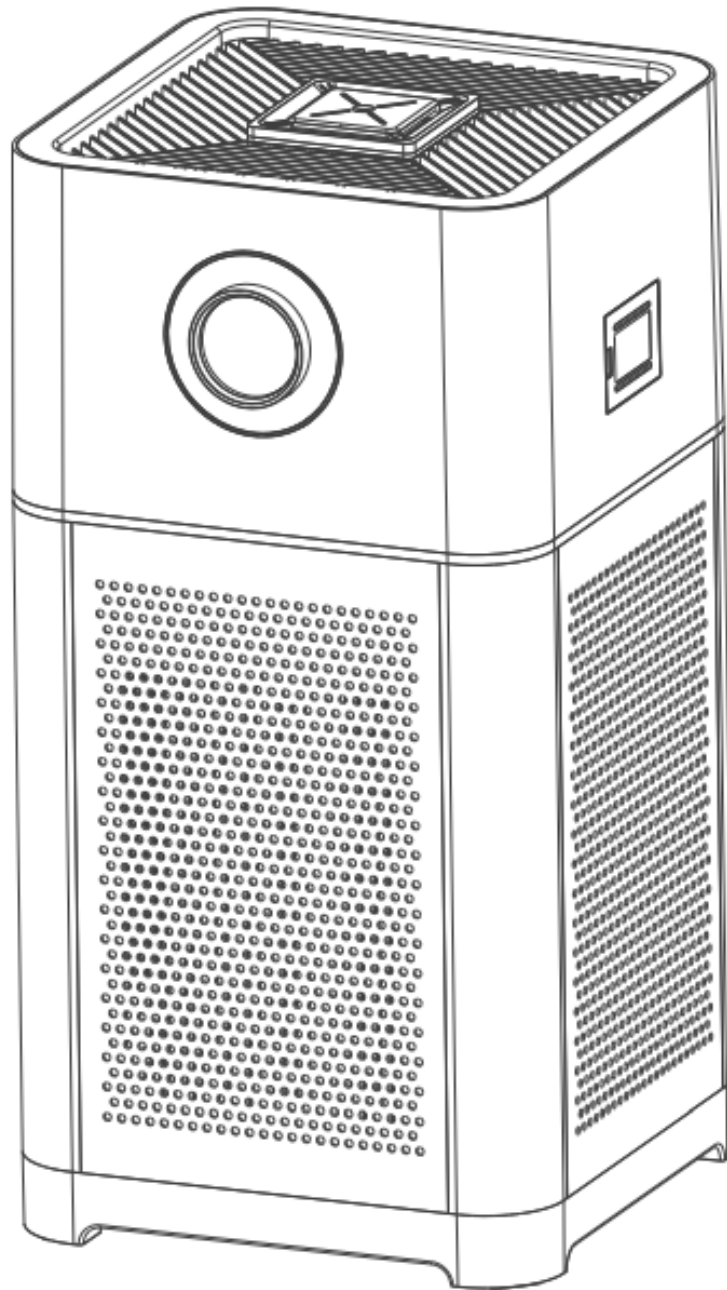

SETUP INSTRUCTIONS





SETUP INSTRUCTIONS

Contents

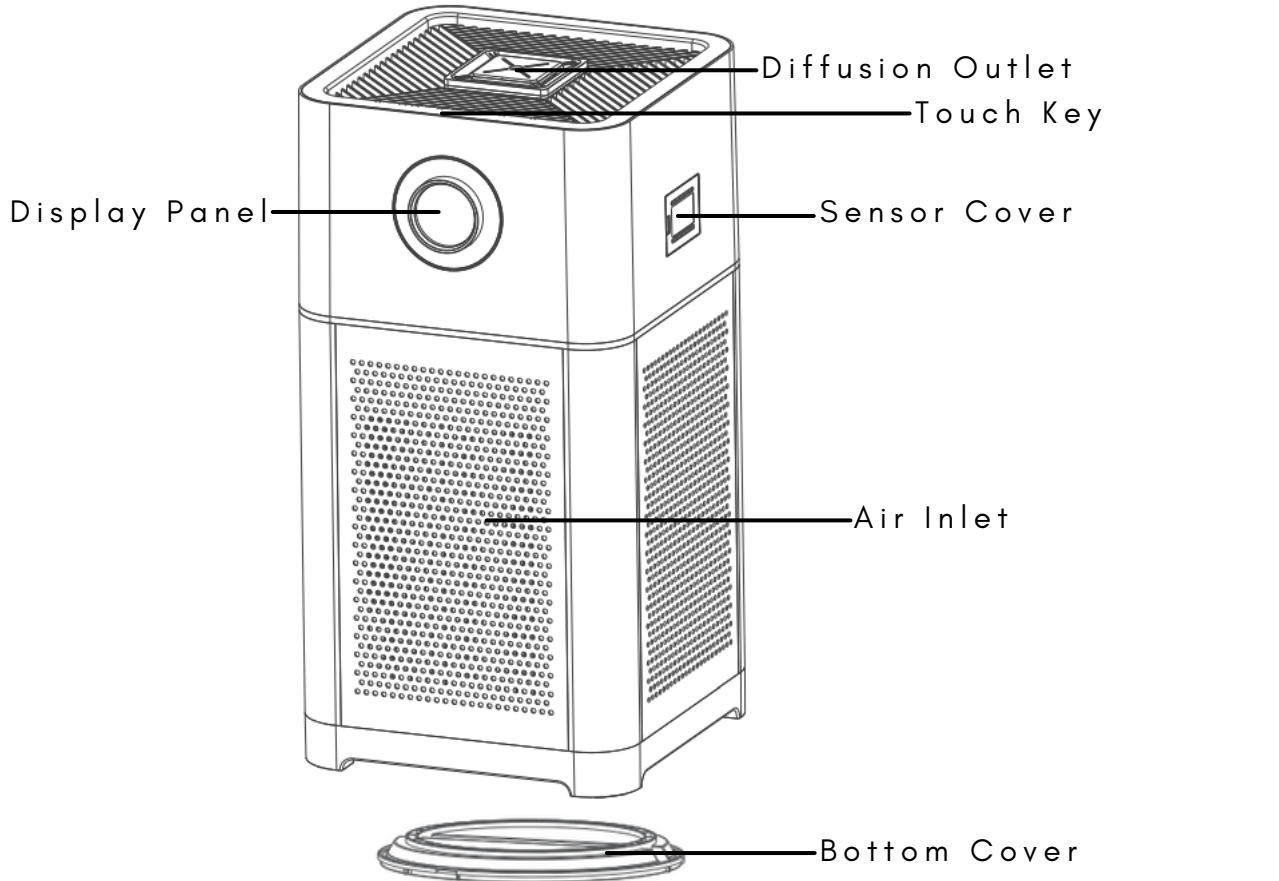

3-in-1 Filter

- Pre Filter - Pollen, Dust and Hair
- Active Carbon Filter - Formaldehyde, Odor and Smoke
- Medical Grade HEPA13 Filter - Virus and Bacteria

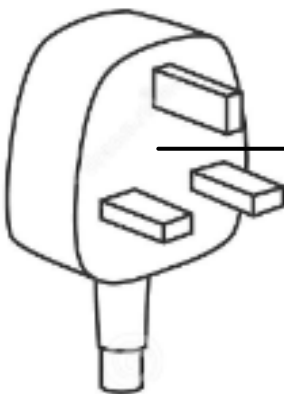

Power Cord



Controller



SETUP INSTRUCTIONS

Installing Filter

1

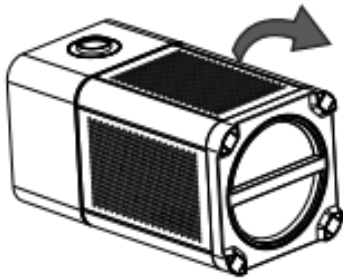

Turn the bottom cover clockwise to open.

2

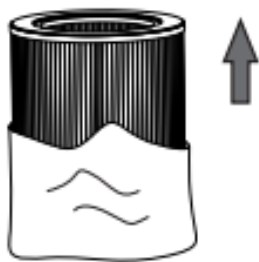

Remove packaging material from filter

3

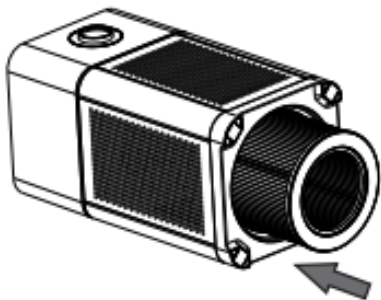

Place filter into Furresh Air

4

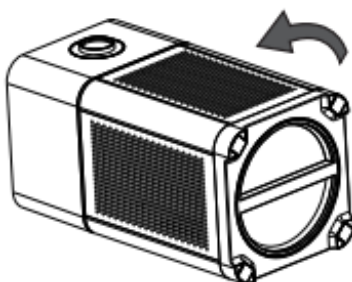

Place bottom cover back and turn Anti-Clockwise



SETUP INSTRUCTIONS

Touch Panel Guide



Power ON/OFF



Control Fan Speed: 1,2,3,4 or Automatic

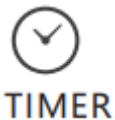

Timer function to set device running time.
Set 1Hr, 4Hr, 8Hr, 12Hr



Switch on UV light function



Turn on Speco mode



Press and Hold for 5 Seconds to enter Set-Up Mode

Hold TIMER and UV-C button for 3 seconds to activate Child Lock. Do same to unlock Child Lock



SETUP INSTRUCTIONS

Product Specifications

Product Name	FURRESH AIR
Product Size	320mm x 320mm x 660mm
Nett Weight	7.05kg
Rated Voltage	DC 24V
Power	45W
Tank Capacity	300ml
Coverage Area	60m ²
Material	ABS
CADR	513m ³ /h
Ip ion volume	30 million cc
Air volume	800m ³ /h
Packing List	Furresh Air, Controller, Power Cable, Filter



SETUP INSTRUCTIONS

Smart Home Set-Up

Step 1: Download Tuya Smart from Google Play Store / IOS App Store
Step 2: Click Sign Up

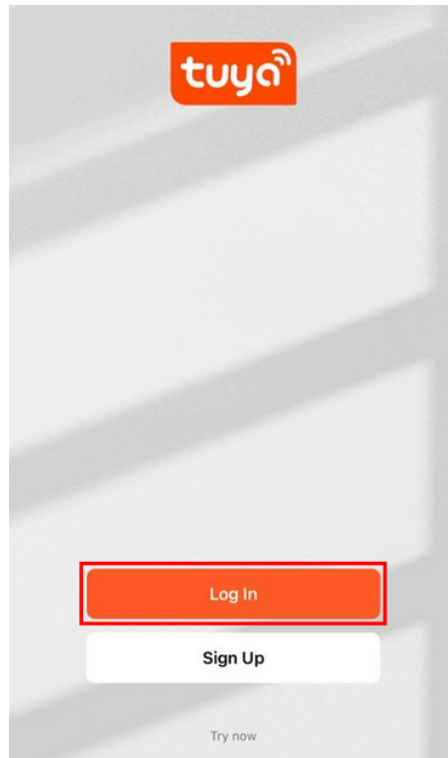

Step 3: Sign Up an Email using Email, Google or Apple



Register

I Agree [Privacy Policy](#) [User Agreement](#) and [Children's Privacy Statement](#)





SETUP INSTRUCTIONS

Smart Home Set-Up

Step 4: Allow permission to local network

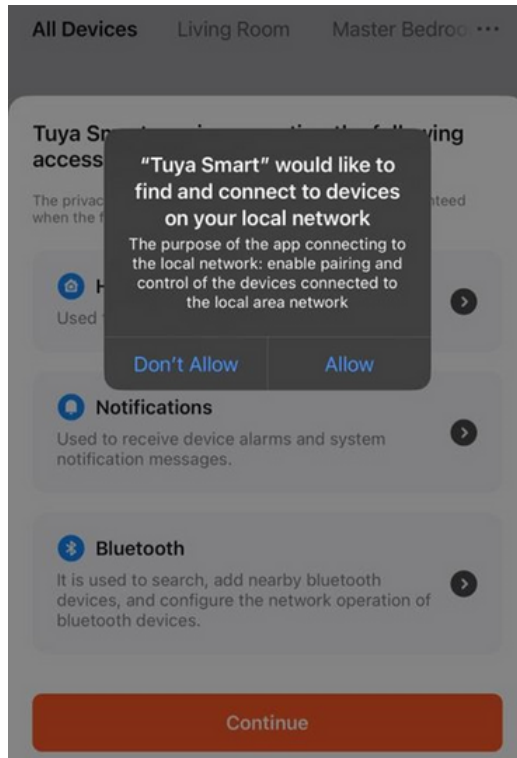

Step 5: Allow permission to bluetooth

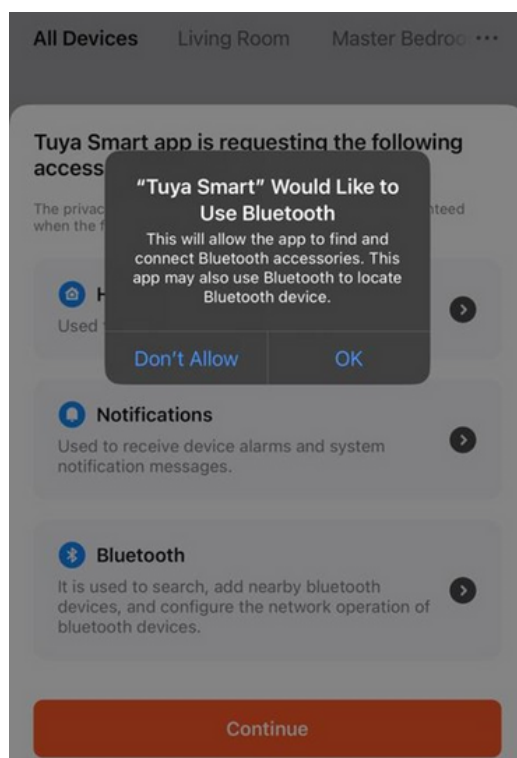



SETUP INSTRUCTIONS

Smart Home Set-Up

Step 6: Allow notifications

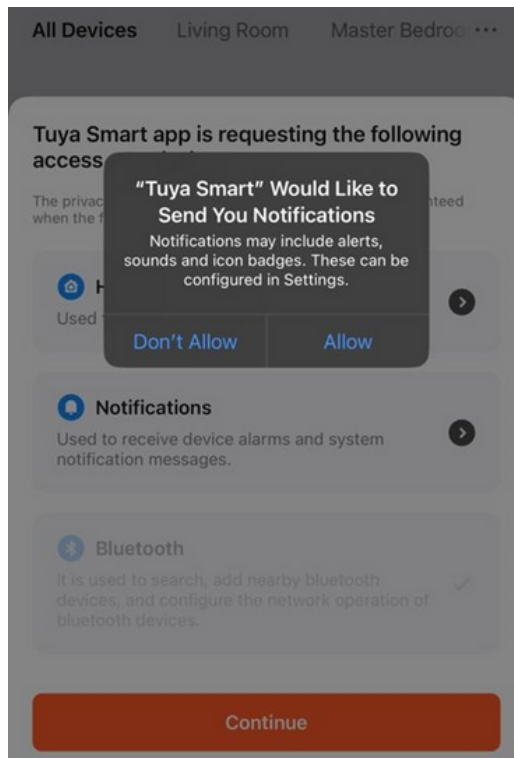

Step 7: Select Add Device

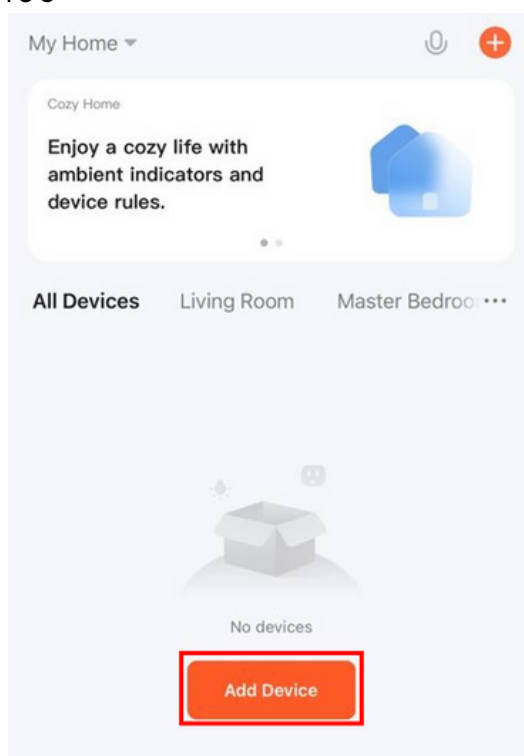



SETUP INSTRUCTIONS

Smart Home Set-Up

Step 8: Allow permission to location

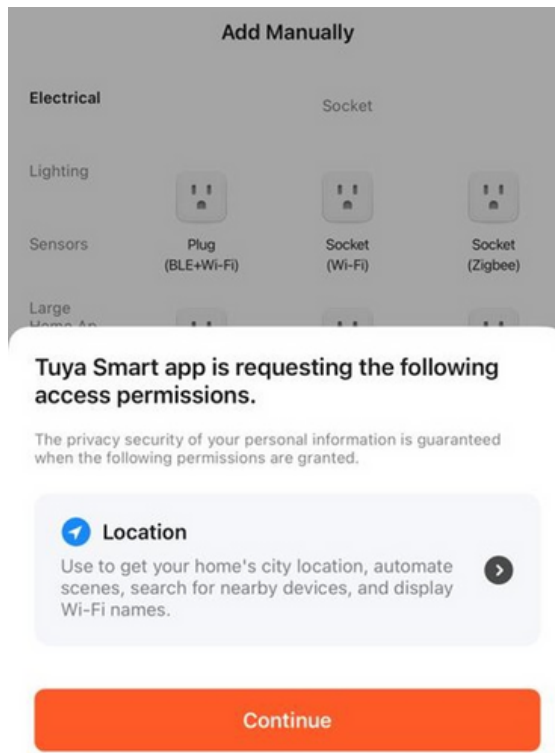

Step 9: Select Add

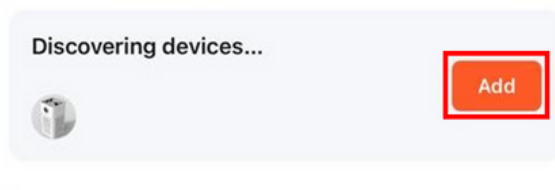



SETUP INSTRUCTIONS

Smart Home Set-Up

Step 10: Connect to 2.4GHz Wi-Fi Network

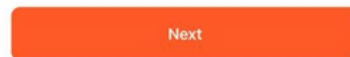

Step 11: You are now able to control Furresh Air via Tuya Smart App!

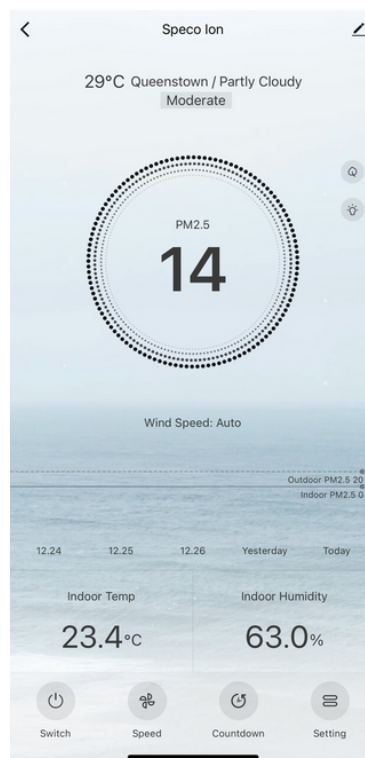



SETUP INSTRUCTIONS

Google Home Set-Up

Step 1: Connect to Google Assistant to Google Home (Skip if done)

Step 2: Open Tuya Smart App and select "Me" tab

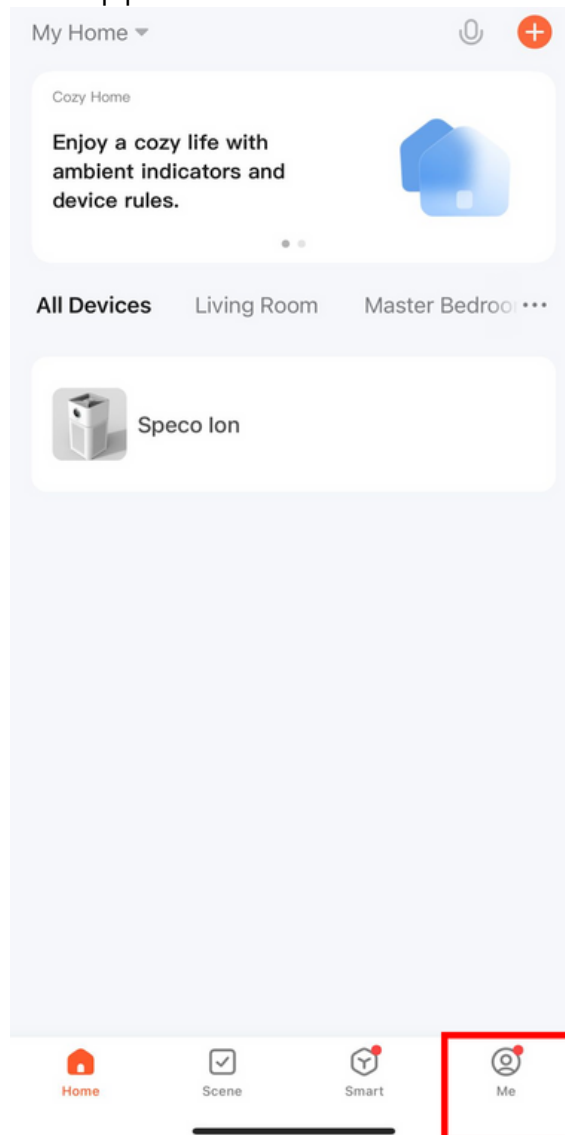



SETUP INSTRUCTIONS

Google Home Set-Up

Step 3: Select Google Assistant

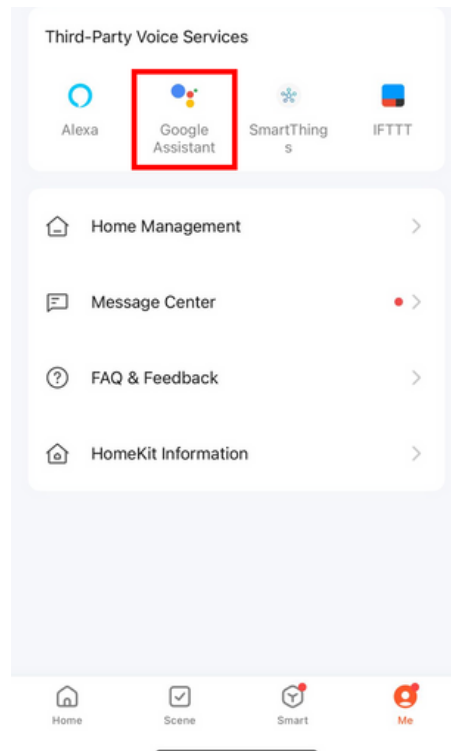

Step 4: Select Link with Google Assistant

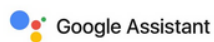

After connecting your App account and Google account, you can use Google Home Smart Speakers to control devices that work with Google Assistant. For example, you can say, "OK Google, please turn on the light."

Link with Google Assistant

[View more ways to link](#)



SETUP INSTRUCTIONS

Google Home Set-Up

Step 5: Select Agree and link



Tuya Smart

**Link your Tuya Smart account
with Google**

The App will have the following permissions after authorization.

· Devices control permission

Agree and link

Cancel

Step 6: Wait page to pop up, select Speco Ion and select Next

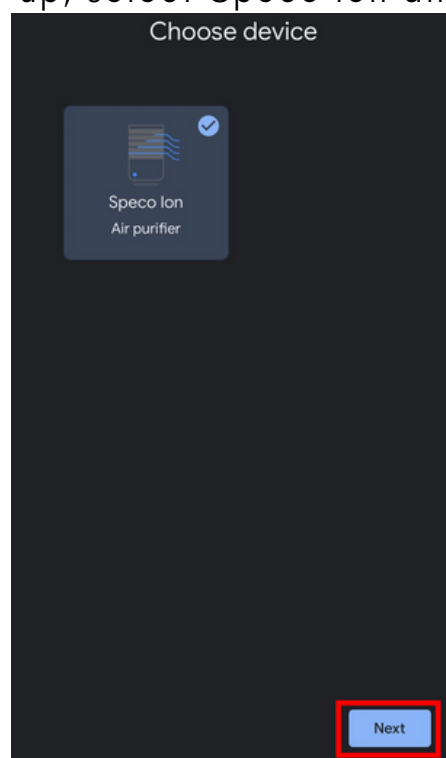



SETUP INSTRUCTIONS

Google Home Set-Up

Step 7: Choose a home and select Next

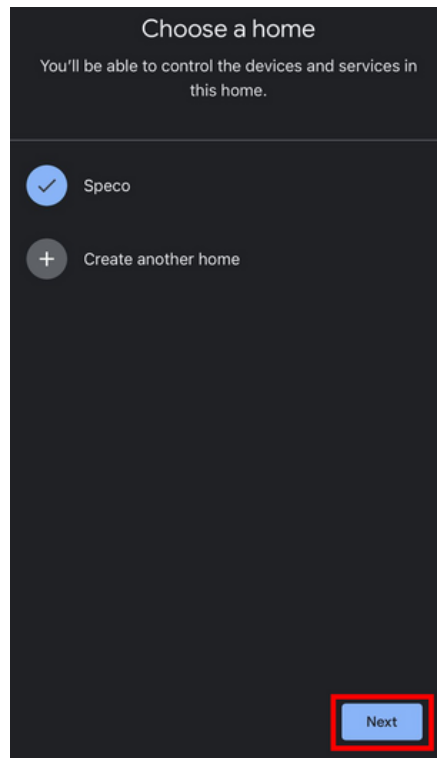

Step 8: Select location for device and select Next.

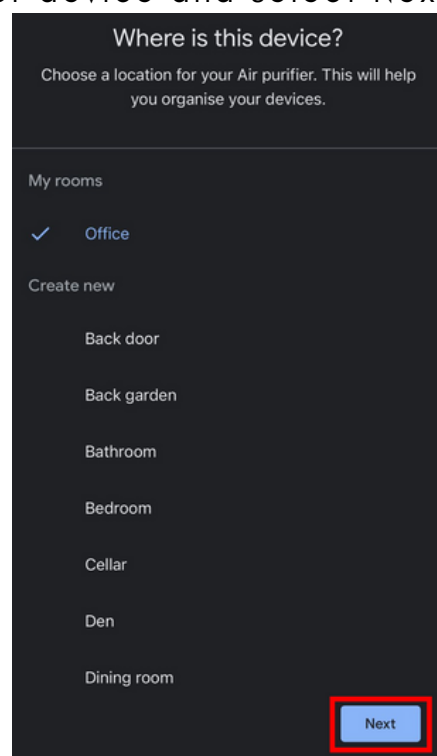



SETUP INSTRUCTIONS

Google Home Set-Up

Step 9: Congrats! You have linked Speco Ion with Google Home!
Try "Hey Google, turn on Ion."

