



**ASSEMBLY GUIDE
GUIDE DE MONTAGE
GUÍA DE MONTAJE**

URBANA

COMBO PARKLETTE PLANTER

JARDINIÈRE COMBINÉE PARKLETTE

JARDINERA COMBO PARKLETTE

VT17526 / VT17626

ESPRESSO
ESPRESSO
ESPRESSO

SLATE
ARDOISE
PIZARRA

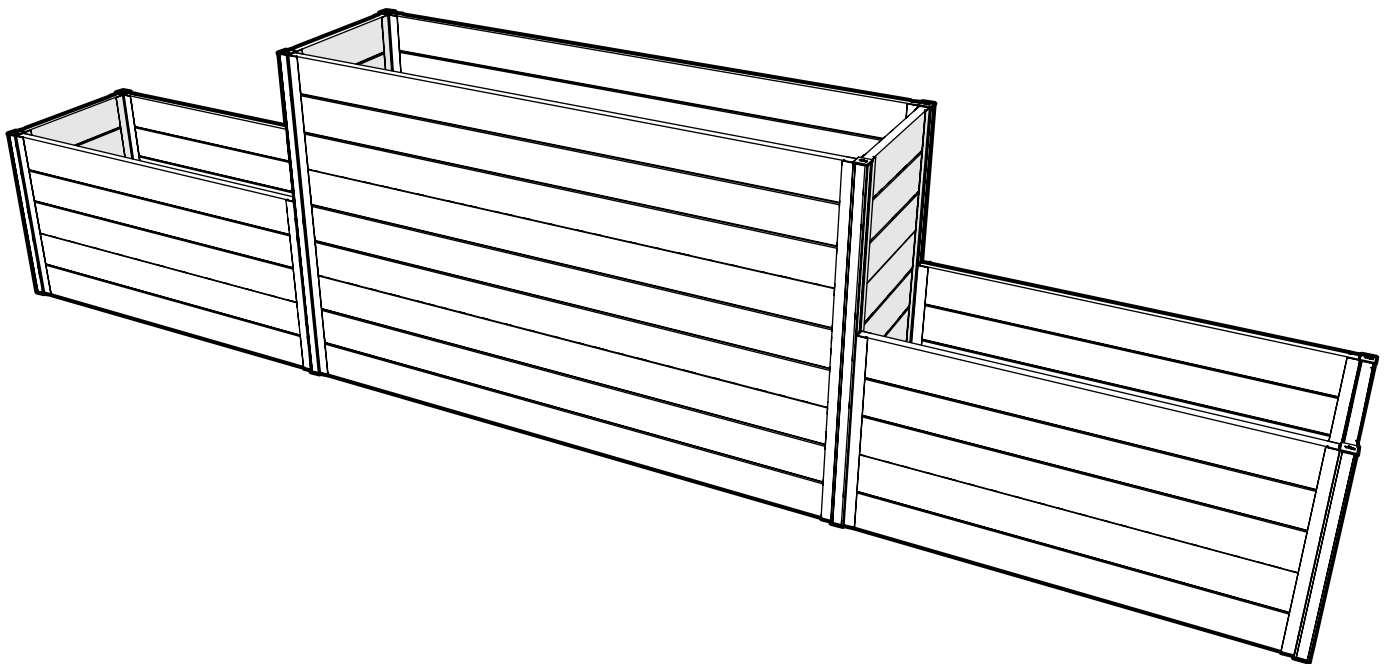

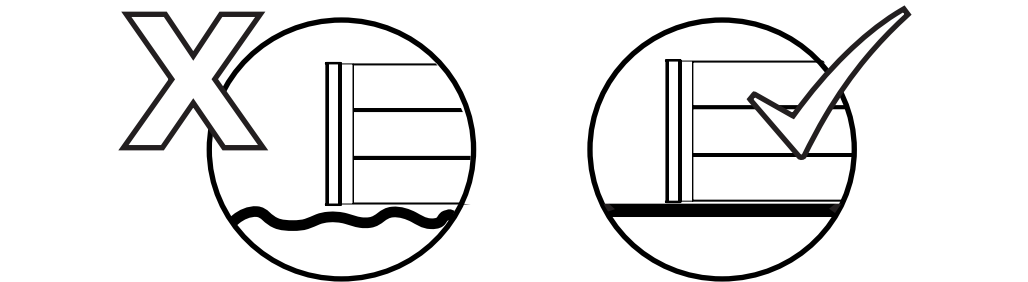
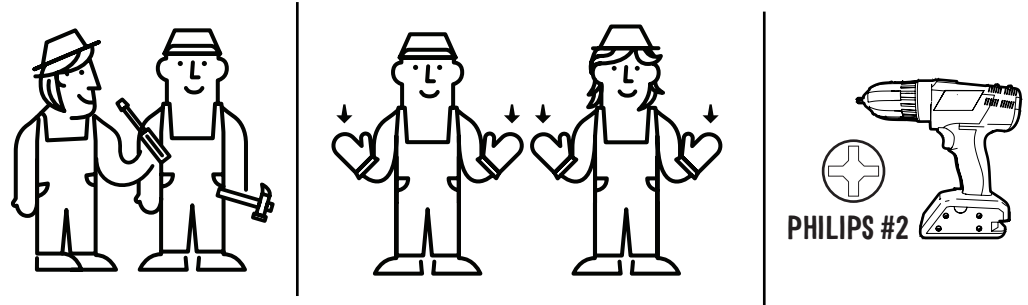
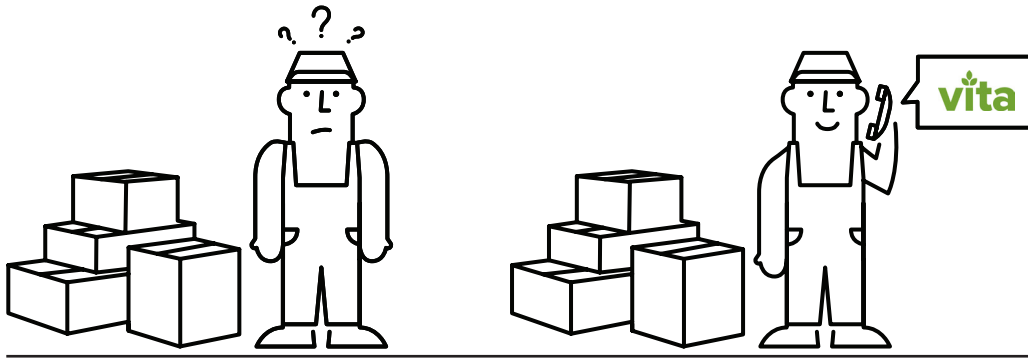

 1-800-282-9346



 [44] 2038 687160



SOS@VITAGARDENS.COM



WWW.VITAGARDENS.COM



8: 00 AM - 4: 00 PM EST



PARTS LIST

LISTE DES PIÈCES

LISTA DE PARTES



16030 - SLATE - ARDOISE - PIZARRA
15030 - ESPRESSO - EXPRESSO - ESPRESSO
BOARD A - PLANCHE A - TABLERO A
54 1/2 IN (138.4 CM) - **X2**

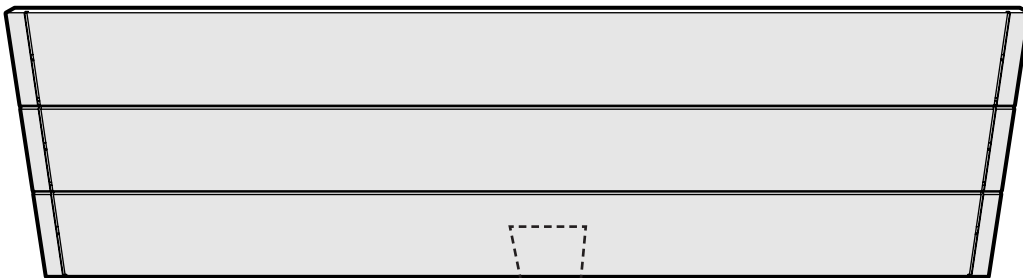

16148 - SLATE - ARDOISE - PIZARRA
15148 - ESPRESSO - EXPRESSO - ESPRESSO
BOARD B - PLANCHE B - TABLERO B
54 1/2 IN (138.4 CM) - **X4**



16020 - SLATE - ARDOISE - PIZARRA
15020 - ESPRESSO - EXPRESSO - ESPRESSO
BOARD C - PLANCHE C - TABLERO C
36 3/8 IN (82.4 CM) - **X4**

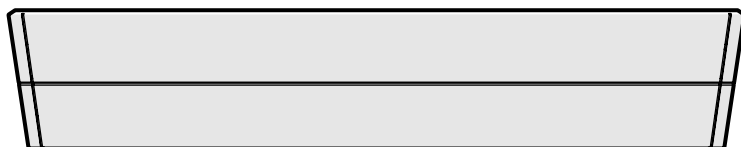

16021 - SLATE - ARDOISE - PIZARRA
15021 - ESPRESSO - EXPRESSO - ESPRESSO
BOARD D - PLANCHE D - TABLERO D
36 3/8 IN (82.4 CM) - **X4**

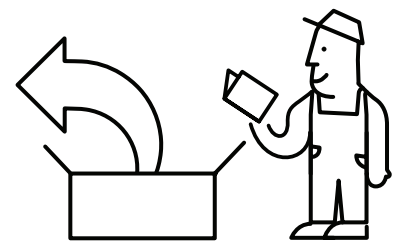



16022 - SLATE - ARDOISE - PIZARRA

15022 - ESPRESSO - EXPRESSO - ESPRESSO

BOARD E - PLANCHE D - TABLERO D

13 5/8 IN (34.7 CM) - **X8**

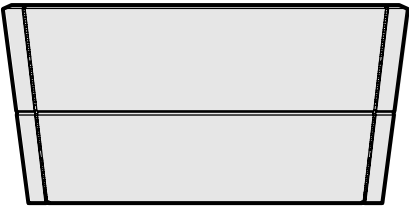

16023 - SLATE - ARDOISE - PIZARRA

15023 - ESPRESSO - EXPRESSO - ESPRESSO

BOARD F - PLANCHE F - TABLERO F

13 5/8 IN (34.7 CM) - **X2**



16032 - SLATE - ARDOISE - PIZARRA

15032 - ESPRESSO - EXPRESSO - ESPRESSO

FLOOR BOARD G - PLANCHE D'ÉTAGE G - TABLERO DE PISO G

14 IN (35.8 CM) - **X2**



16033 - SLATE SLATE - ARDOISE - PIZARRA

15033 - ESPRESSO - EXPRESSO - ESPRESSO

FLOOR BOARD H - PLANCHE D'ÉTAGE H - TABLERO DE PISO H

14 IN (35.8 CM) - **X3**

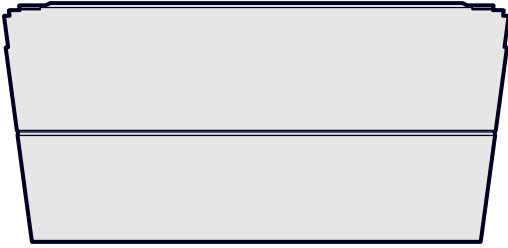

16024 - SLATE - ARDOISE - PIZARRA

15024 - ESPRESSO - EXPRESSO - ESPRESSO

FLOOR BOARD I - PLANCHE D'ÉTAGE I - TABLERO DE PISO I

14 IN (35.8 CM) - **X2**



16025 - SLATE - ARDOISE - PIZARRA

15025 - ESPRESSO - EXPRESSO - ESPRESSO

FLOOR BOARD J - PLANCHE D'ÉTAGE J - TABLERO DE PISO J

14 IN (35.8 CM) - **X3**



16028 - SLATE - ARDOISE - PIZARRA

15028 - ESPRESSO - EXPRESSO - ESPRESSO

CROSS BRACE K - ENTRETOISE K - BRAZO CRUZADO K

13 3/4 IN (35.2 CM) - **X3**



16031 - SLATE SLATE - ARDOISE - PIZARRA

15031 - ESPRESSO - EXPRESSO - ESPRESSO

FLOOR BRACE L - BRACE DE PLANCHER L - BRACE DE PISO L

54 1/2 IN (138.4 CM) - **X2**

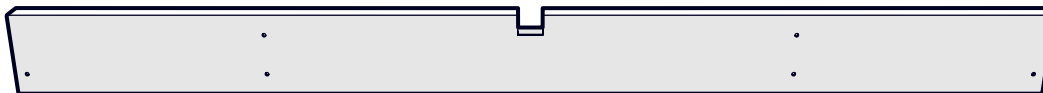

16026 - SLATE SLATE - ARDOISE - PIZARRA

15026 - ESPRESSO - EXPRESSO - ESPRESSO

FLOOR BRACE M - BRACE DE PLANCHER M - BRACE DE PISO M

36 3/8 IN (92.4 CM) - **X4**



16029

POST O - PUBLIER O - EXPONER O

33" (83.7 CM) - **X2**



16044
POST P - PUBLIER P - EXPONER P
33" (83.7 CM) - **X2**



16019 - **POST Q** - PUBLIER Q - EXPONER Q - **X2**



16043 - **POST R** - PUBLIER R - EXPONER R - **X2**

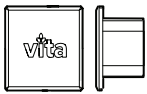

16003
POST CAP
ETE DE POTEAU
TAPON
X16



16067
LOCKING TAB
ONGLET DE VERROUILLAGE
PESTAÑA DE BLOQUEO
X2

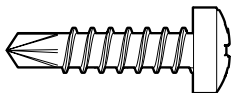

20066
SCREW S
VISSER S
TORNILLO S
5/8IN (1.6CM)
X12

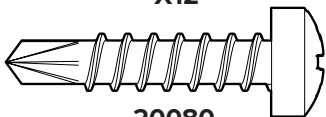

20080
SCREW T
VISSER T
TORNILLO T
1 1/4IN (3.2CM)
X28

PRODUCT DIMENSIONS

DIMENSIONS DU PRODUIT

DIMENSIONES DEL PRODUCTO

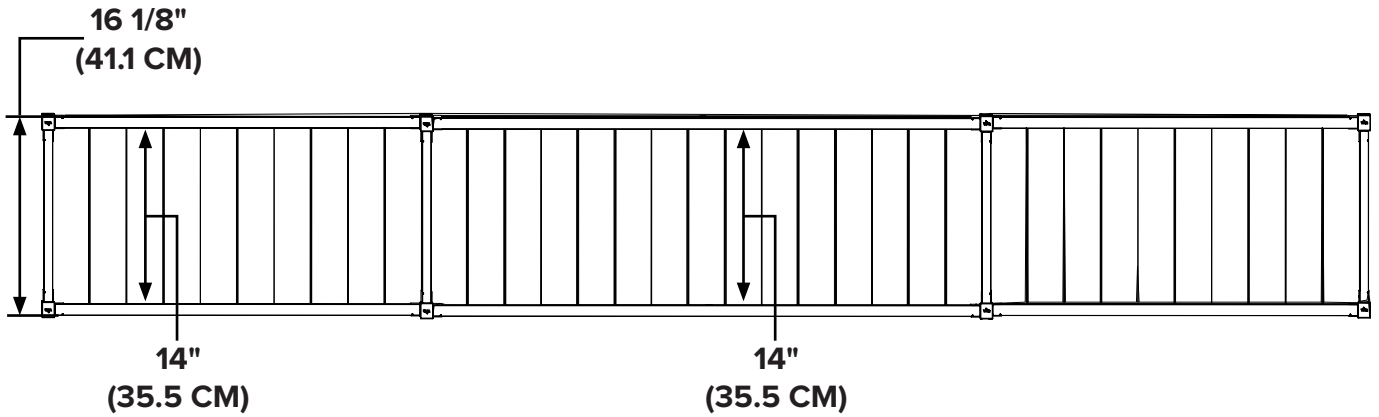

DIMENSION OF FALSE BOTTOM
DIMENSION DE FAUX FOND
DIMENSIÓN DE FALSO FONDO

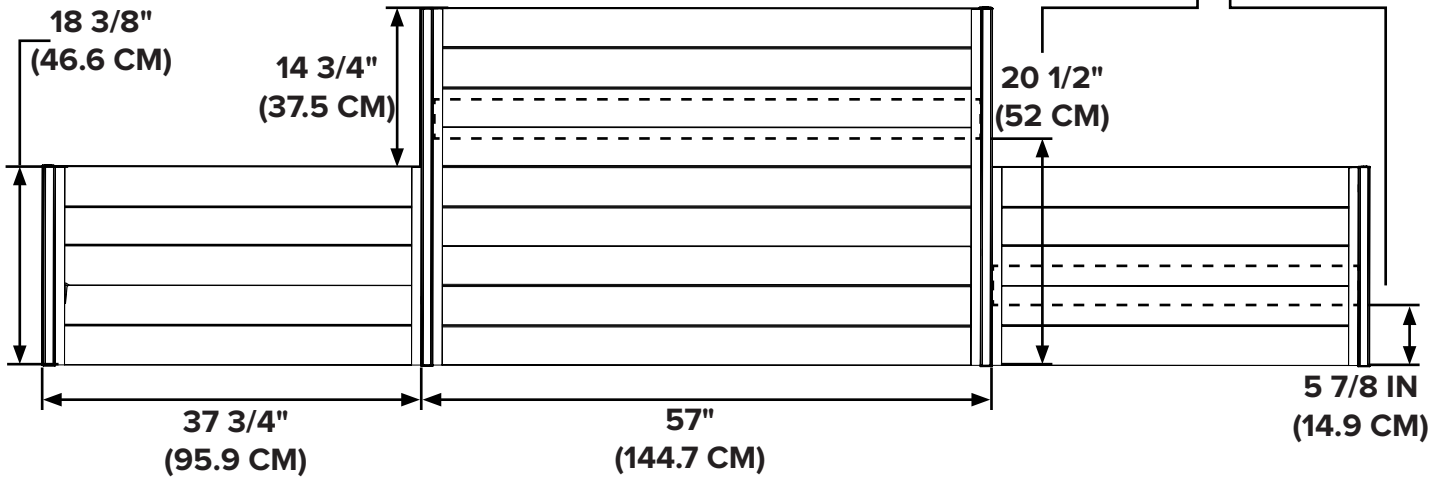

<p>CU M ----- 0.43</p> <p>CU FT ----- 15.2</p> <p> ----- 14 (30L/1.5CU FT.) </p>	<p>CU M ----- 0.16</p> <p>CU FT ----- 5.7</p> <p> ----- 10 (FOR BOTH) (POUR LES DEUX) (PARA AMBOS) </p>
--	---

33"
(83.8 CM)

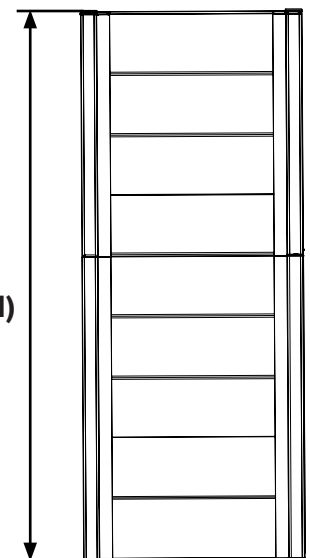

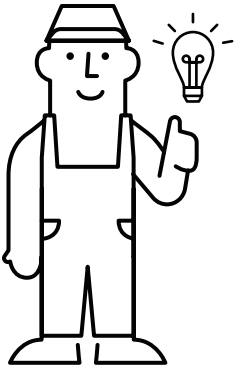

THESE THREE SCREW HOLES ALLOW YOU TO POSITION YOUR FLOOR BRACE AT DIFFERENT DEPTHS. CHOOSE YOUR DEPTH ACCORDING TO WHAT YOU WILL BE PLANTING AND HOW MUCH SOIL IS NEEDED!

CES TROIS TROUS DE VIS VOUS PERMETTENT DE POSITIONNER VOTRE CONTREVENTEMENT À DIFFÉRENTES PROFONDEURS. CHOISISSEZ VOTRE PROFONDEUR EN FONCTION DE CE QUE VOUS ALLEZ PLANTER ET DE LA QUANTITÉ DE TERRE NÉCESSAIRE!

ESTOS TRES ORIFICIOS PARA TORNILLOS LE PERMITEN COLOCAR LA RIOSTRA DEL PISO A DIFERENTES PROFUNDIDADES. ¡ELIJA SU PROFUNDIDAD DE ACUERDO CON LO QUE VA A PLANTAR Y LA CANTIDAD DE TIERRA QUE SE NECESITA!

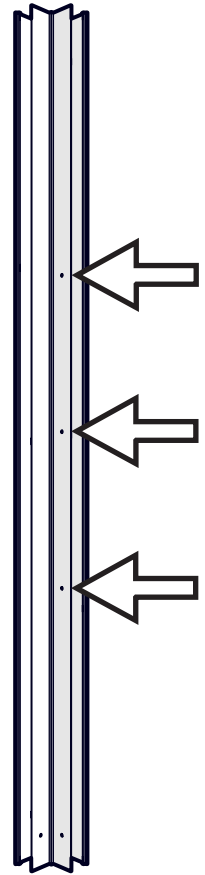

- 16030/15030 - x2 (A)
- 16148/15148 - x4 (B)
- 16067 - x2
- 16029 - x2 (O)
- 16044 - x2 (P)

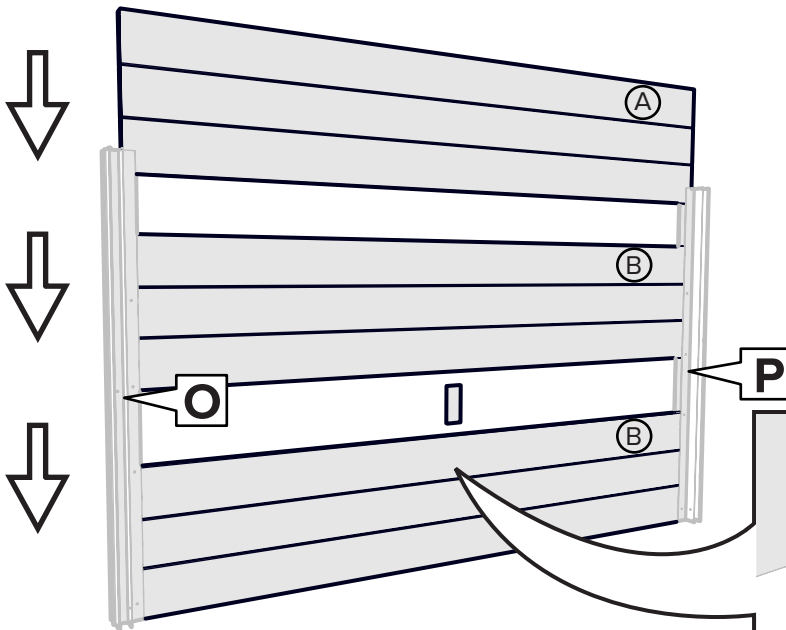

X2



2

20066 - x4 (S) 

20080 - x12 (T) 

16031/15031 - x2 (L) 

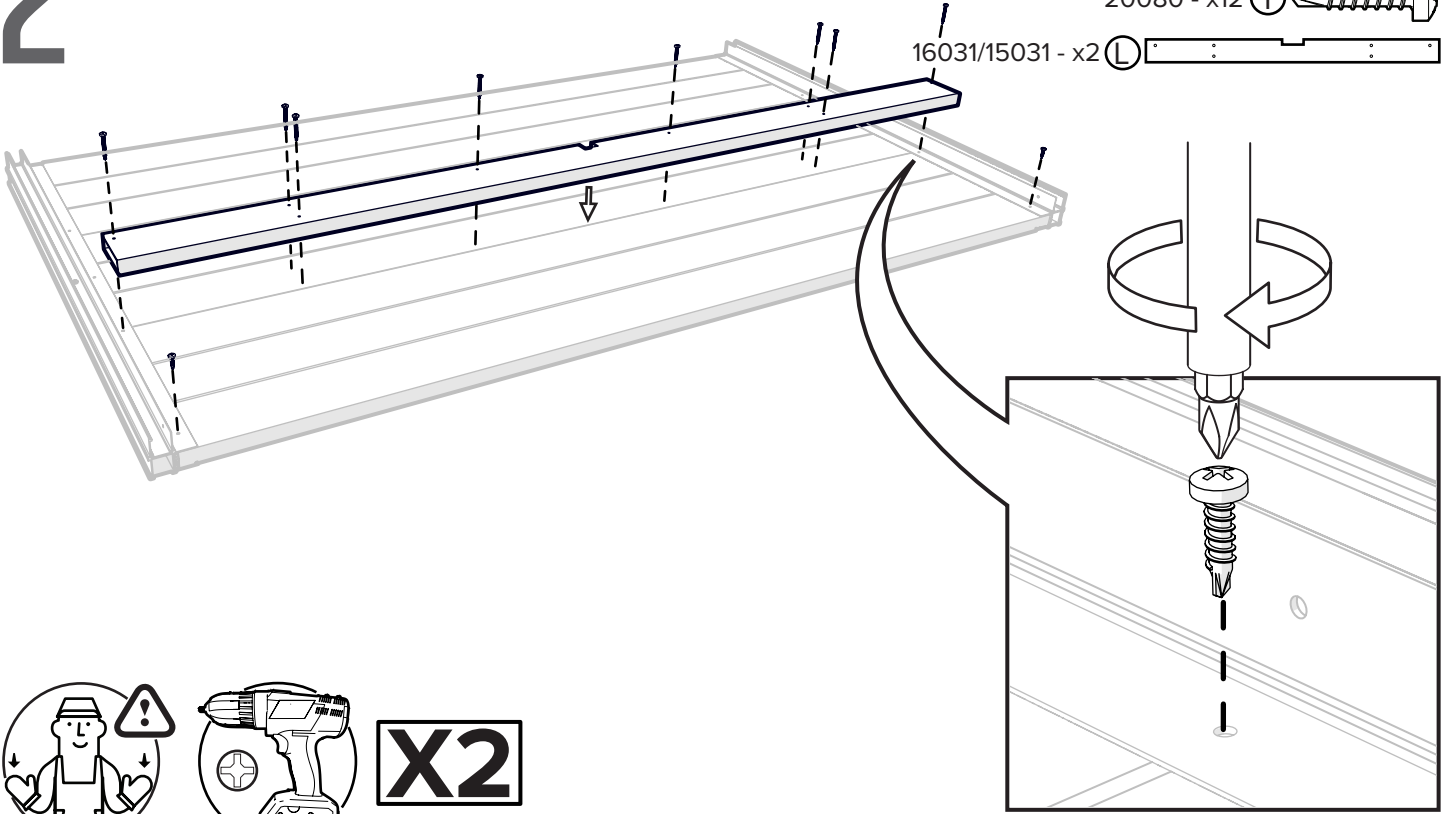

PHILIPS #2

X2

3

16022/15022 - x6 (E) 

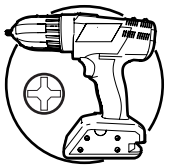
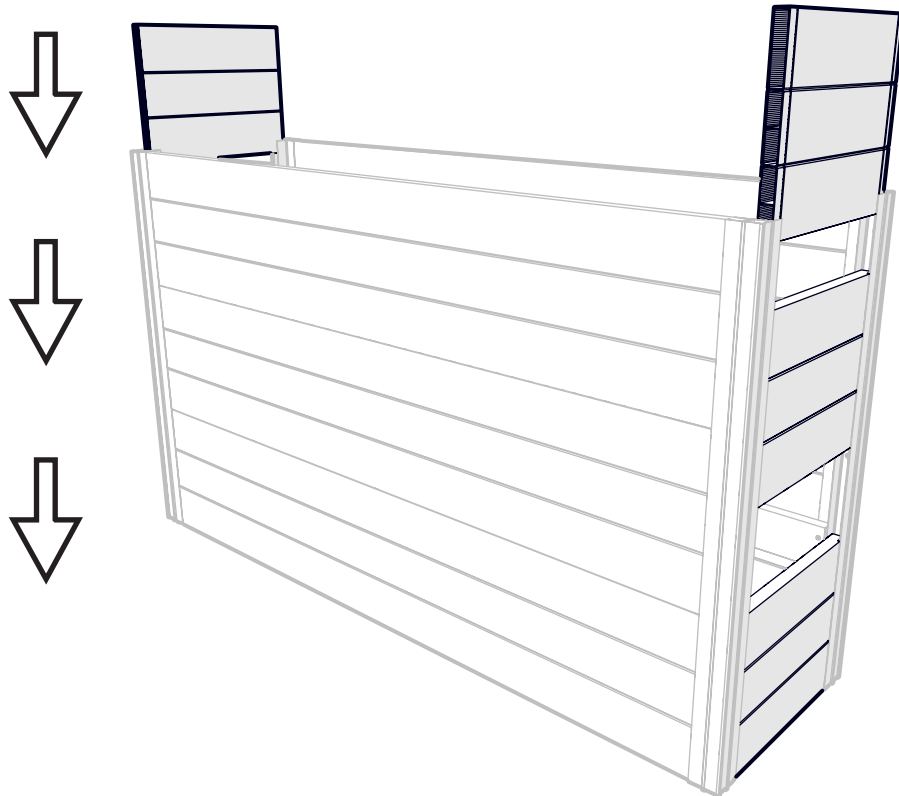

PHILIPS #2

4

20066 - x4 

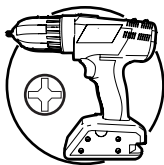
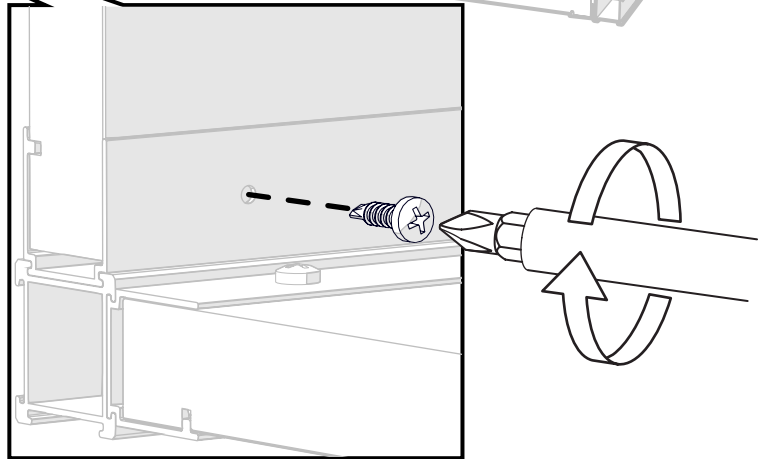
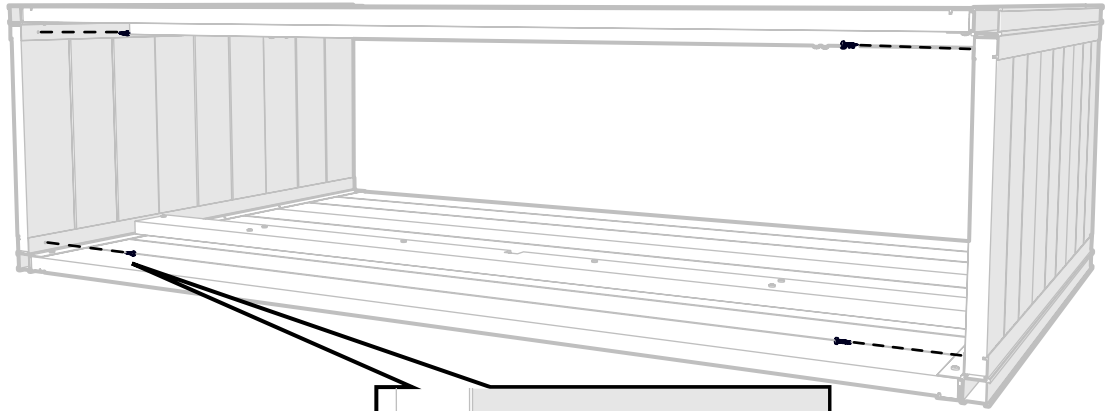

PHILIPS #2

5

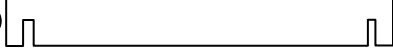
16028/15028 - x1 

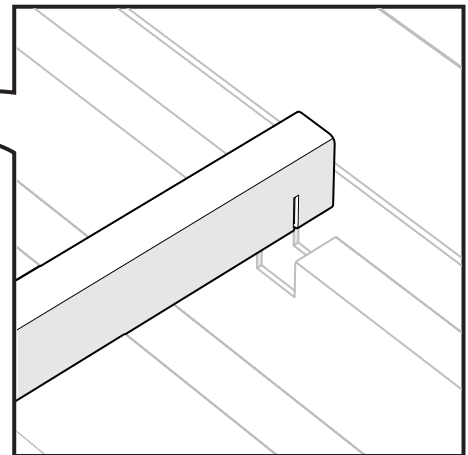
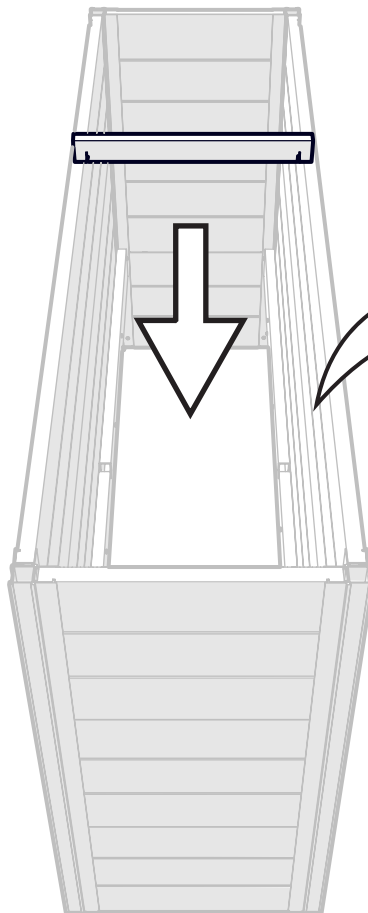

6



16032/15032 - x2 (G)



16033/15033 - x3 (H)

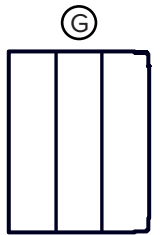
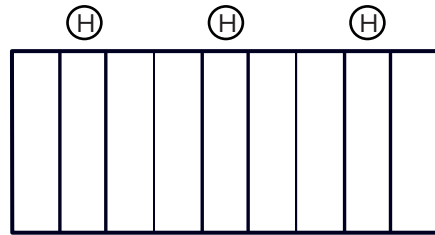
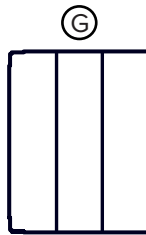
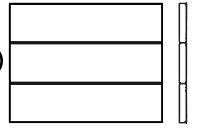

7

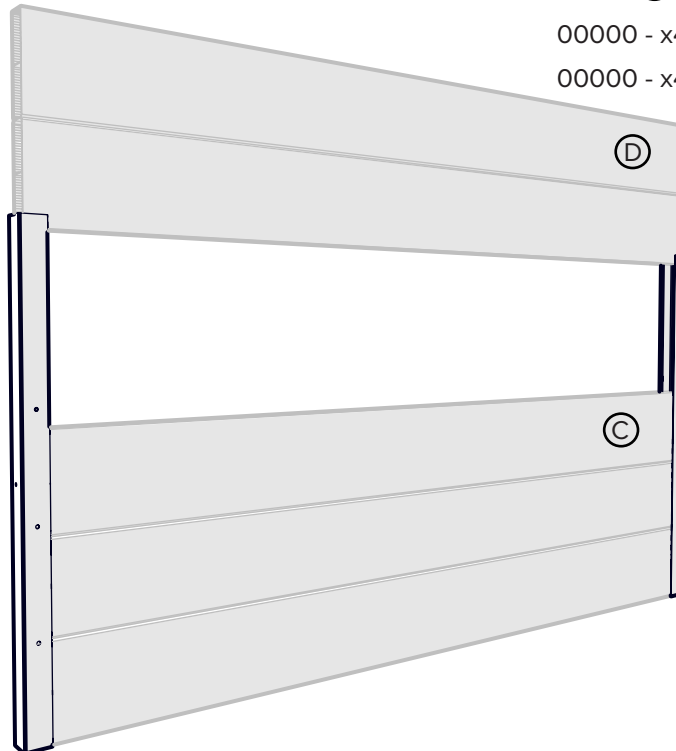

16020/15020 - x4 (C)

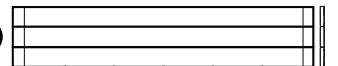

16021/15021 - x4 (D)

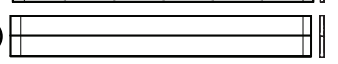

00000 - x4

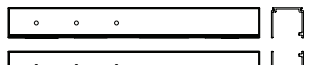

00000 - x4



X4

8

15026/16026 - x4 (M) 

20066 - x4 (S) 

20080 - x12 (T) 

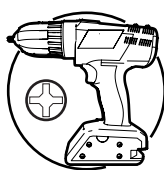
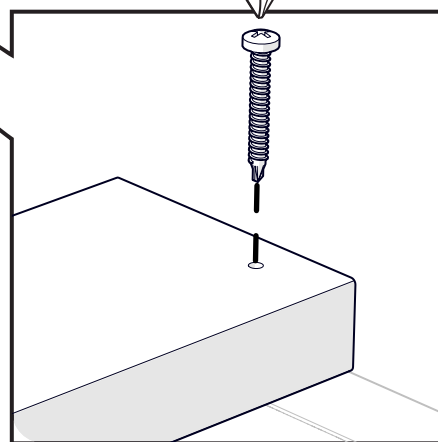
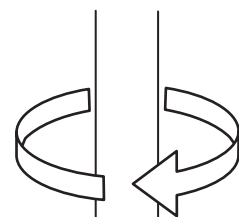
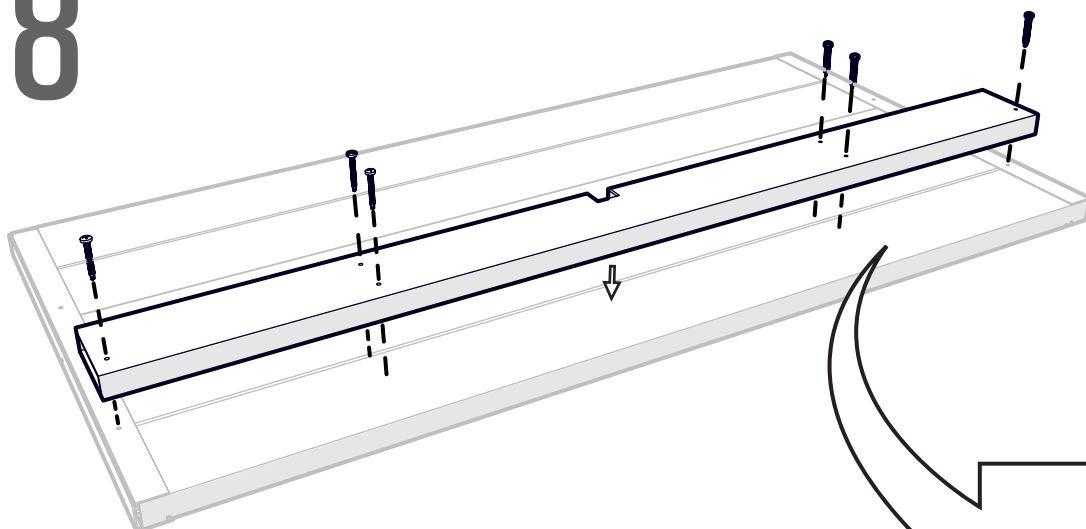

X4

PHILIPS #2

9

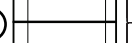
16023/15023 - x2 (F) 

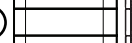
16022/15022 - x2 (E) 

00000 - x2 

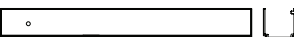
00000 - x2 

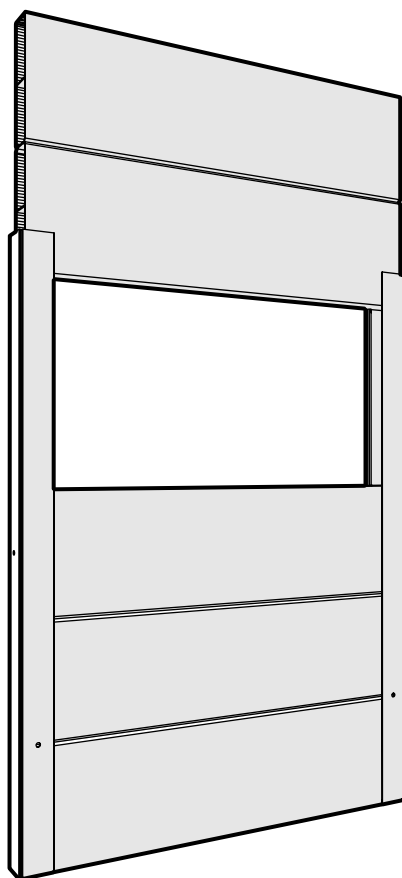

X2

10

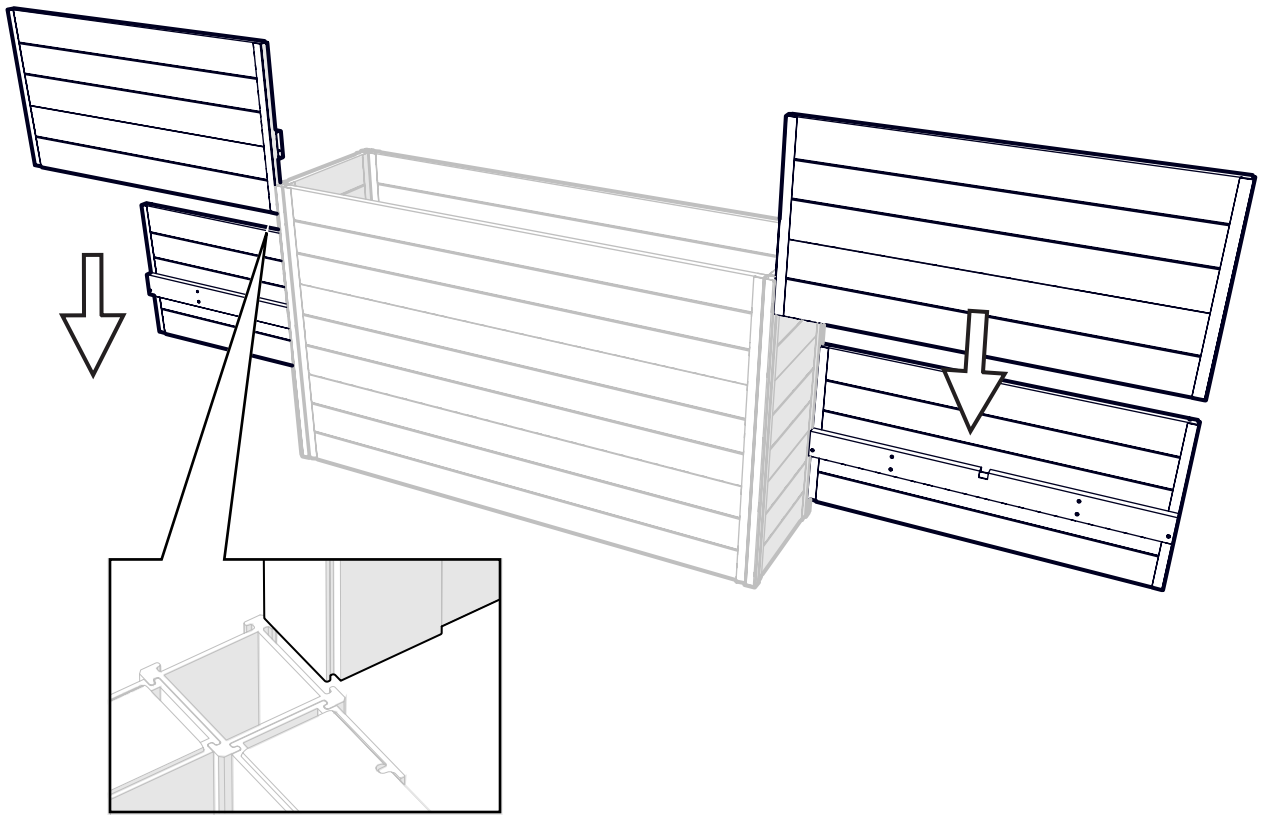

11

00000 - x4 

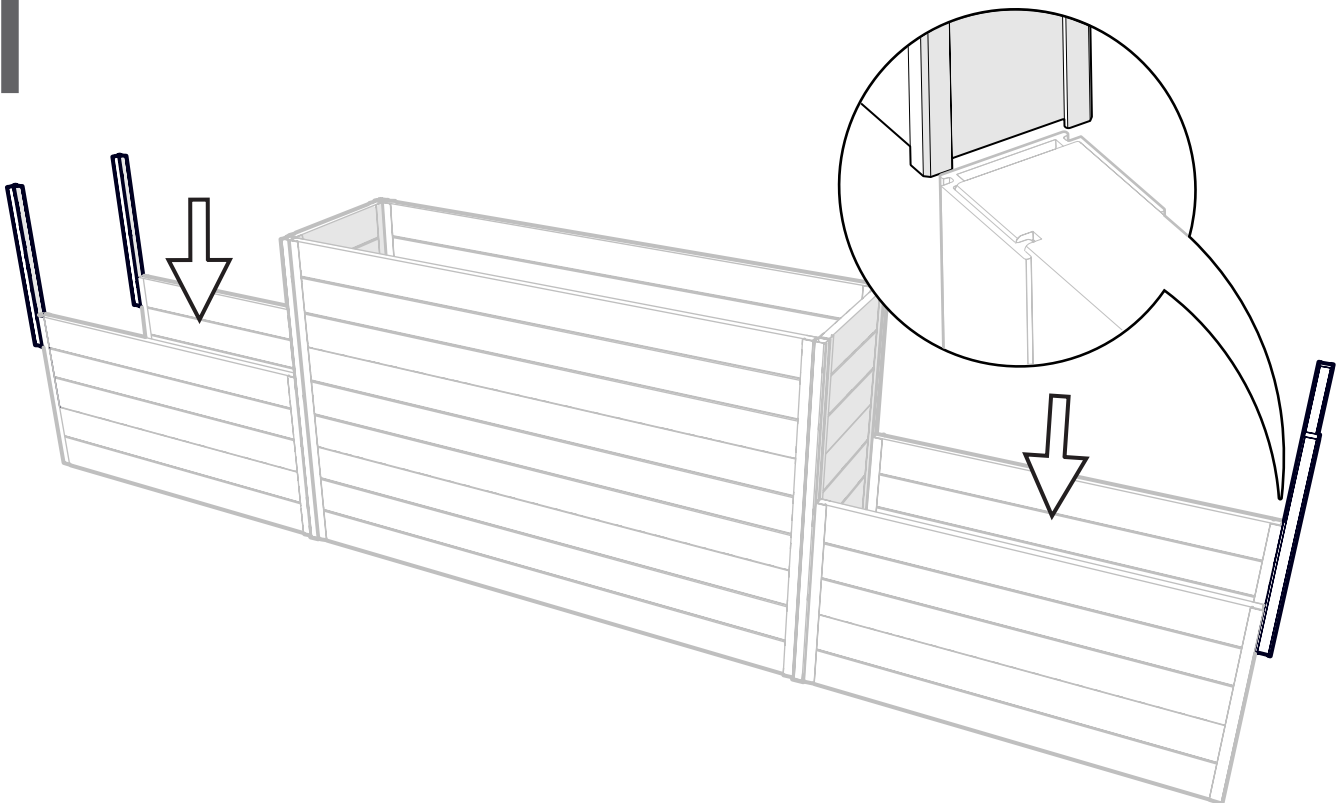

12

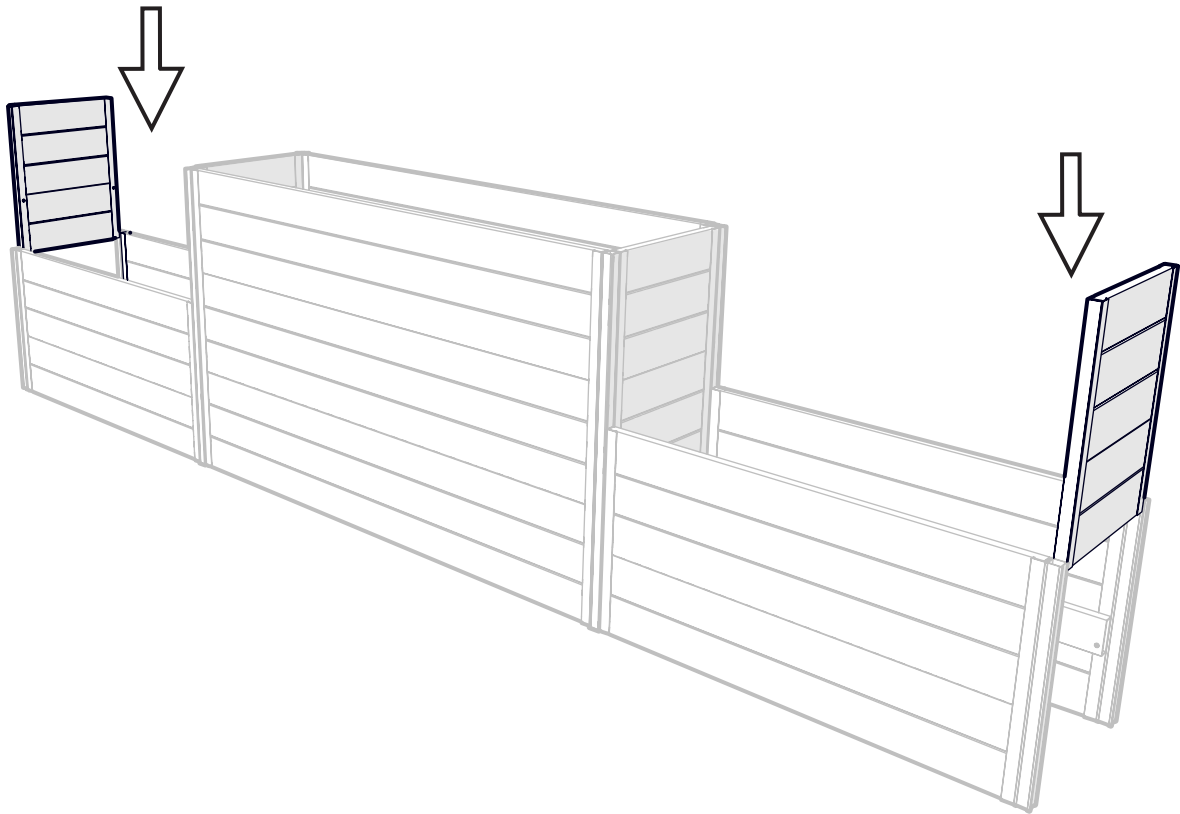

13

16028/15028 - x1 (K)

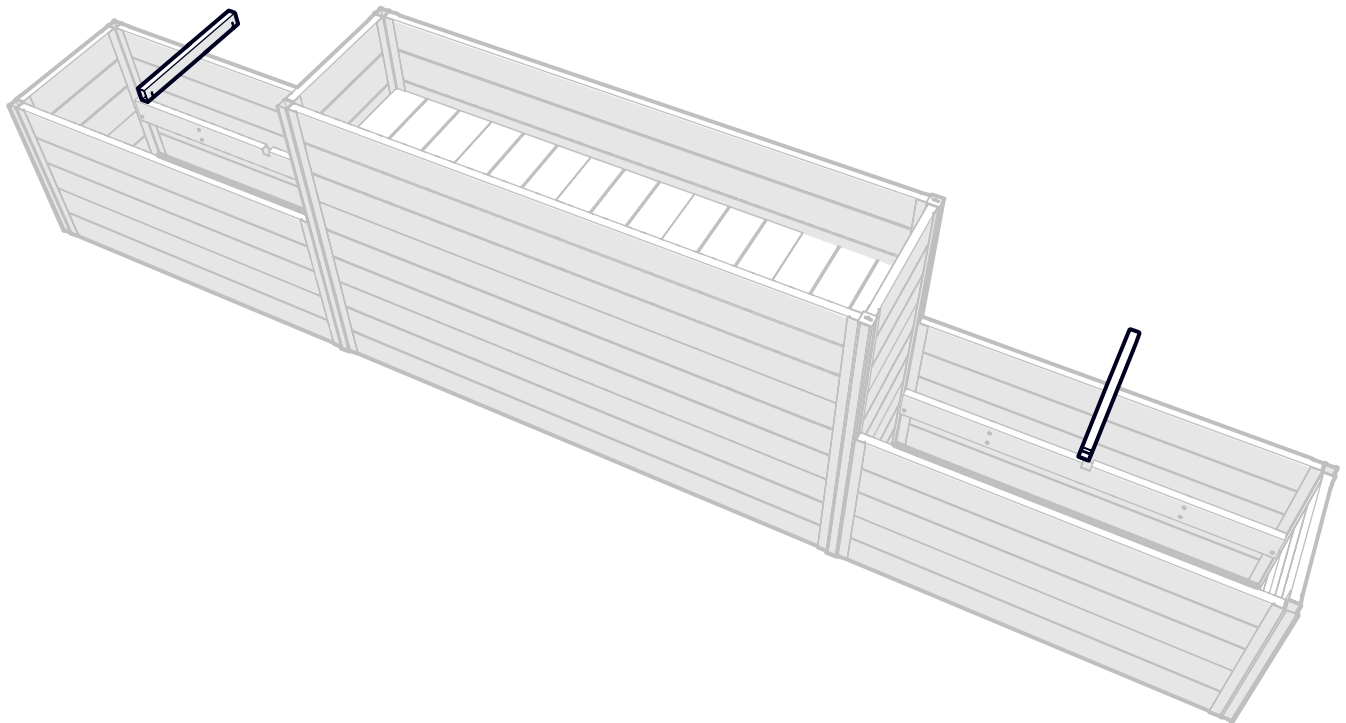
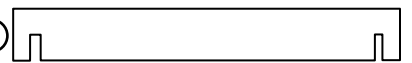

14

16325 - x8

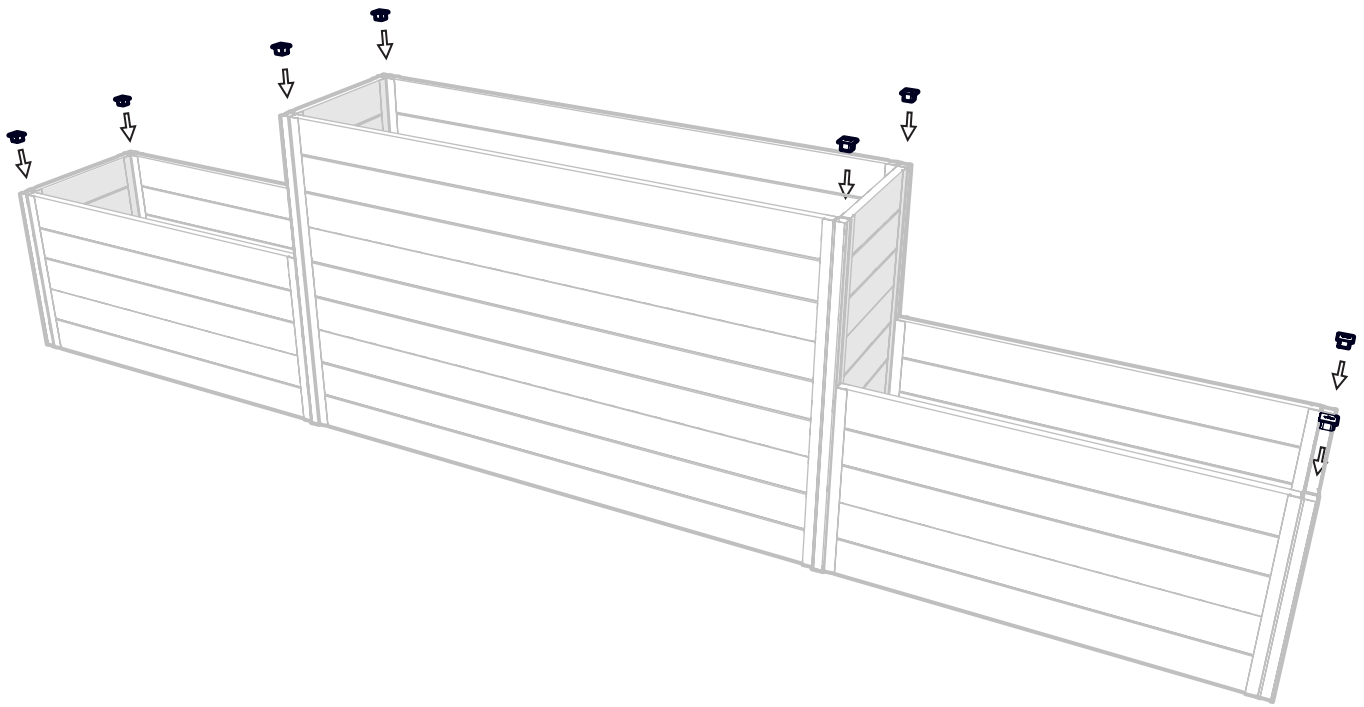

15

16024/15024 - x4

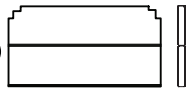

16025/15025 - x6

