



**ASSEMBLY GUIDE
GUIDE DE MONTAGE
GUÍA DE MONTAJE**

MEZZA

6X6 KEYHOLE GARDEN

6X6 JARDIN DE TROU DE SERRURE

6X6 JARDIN DE OJO DE CERRADURA

VT17707

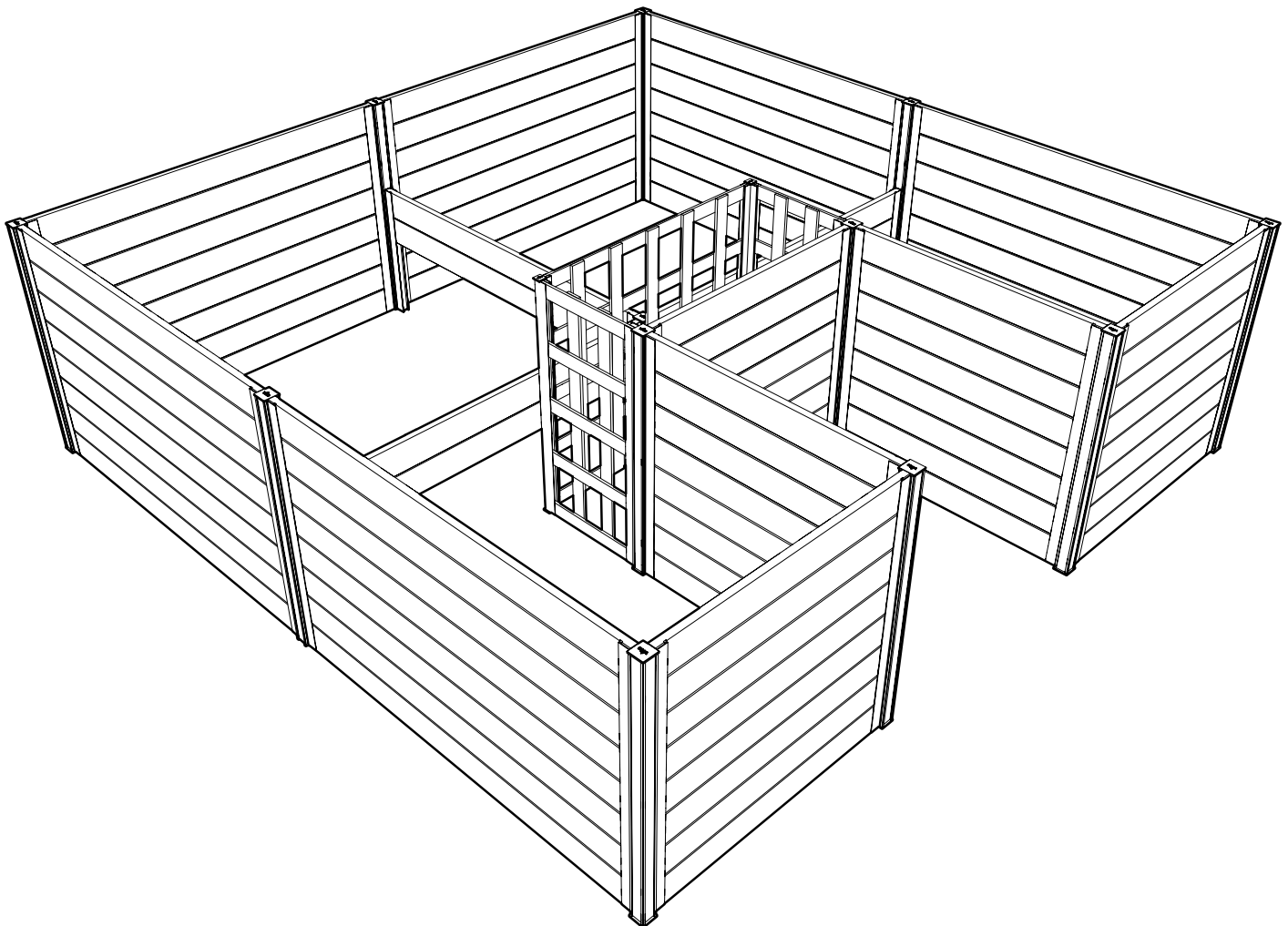

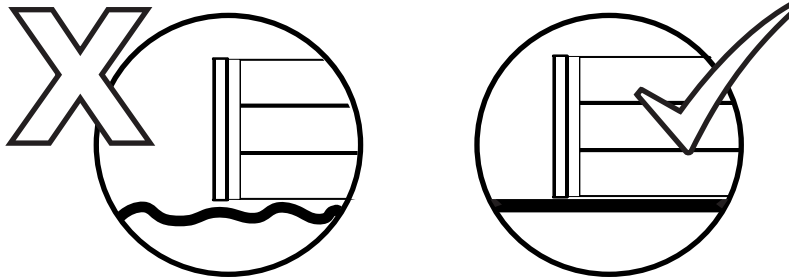
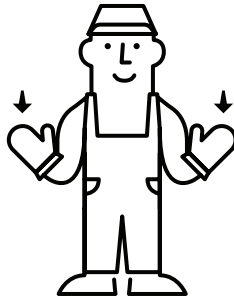
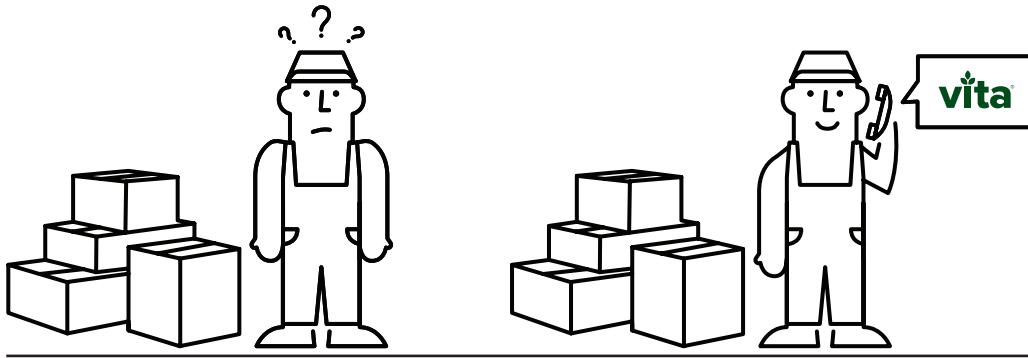

 1-844-880-8482



 (44) 2038 687160



SOS@VITAGARDENS.COM



WWW.VITAGARDENS.COM



8: 00 AM - 4: 00 PM EST



PARTS LIST

LISTE DES PIÈCES

LISTA DE PARTES



17019
C-CHANNEL - C-CHAÎNE - C-CANAL
X24



17037
C-CHANNEL - C-CHAÎNE - C-CANAL
X6

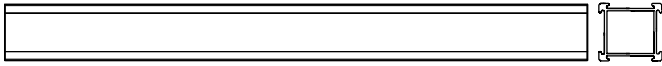

17018
POST - PUBLIER - EXPONER
X11

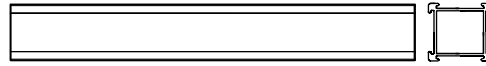

17039
POST - PUBLIER - EXPONER
X1



17030
TOP BOARD A - CONSEIL SUPERIEUR A - TABLERO SUPERIOR A
34 1/8IN (86.74 CM) - **X9**



17031
STACKING BOARD A - TABLEAU DE EMPILAGE A - PTABLERO DE APILAMIENTO A
34 1/8IN (86.74CM) - **X45**



17032
TOP BOARD B - CONSEIL SUPERIEUR B - TABLERO SUPERIOR B
22 3/8 IN (56.84 CM) - **X5**

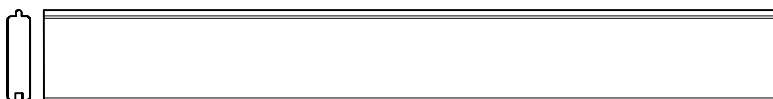

17033
STACKING BOARD B - TABLEAU DE EMPILAGE B - PTABLERO DE APILAMIENTO B
22 3/8IN (56.84 CM) - **X35**

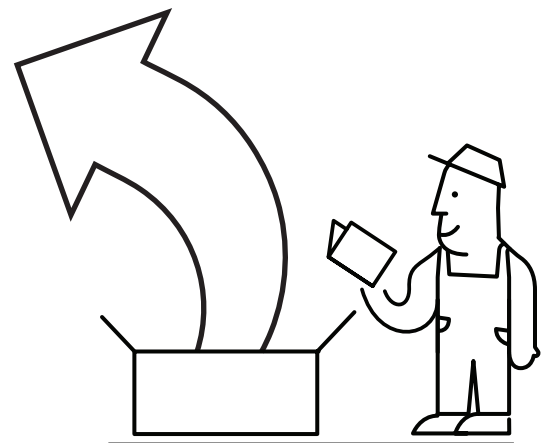

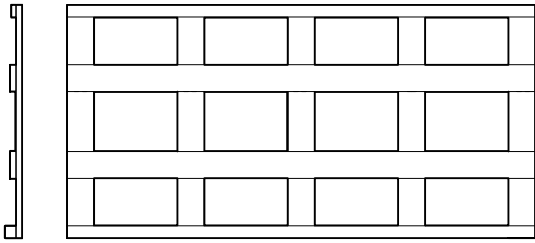

17034
BASKET PANEL A - PANNEAU DE PANIER A - PANEL DE CESTA A
X2

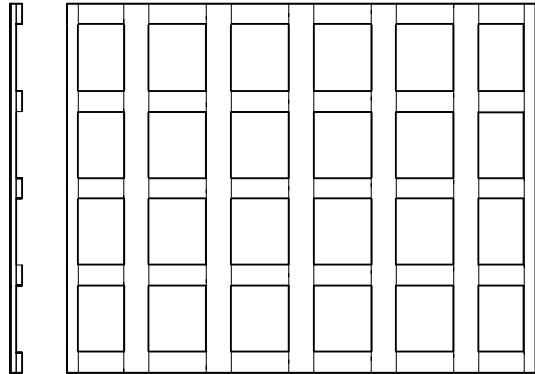

17035
BASKET PANEL B - PANNEAU DE PANIER B - PANEL DE CESTA B
X1

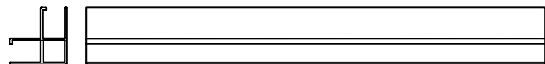

17021
BASKET POST - POSTE DE PANIER - CESTA POST
X2



17022
BASKET POST CAP - CAP PANIER - GORRA DE CESTA
X4



17020
POST CAP - TETE DE POTEAU - TAPON
X24

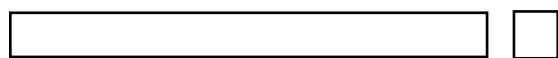

17038
WOOD BLOCK - BLOC DE BOIS - BLOQUE DE MADERA
7 7/8IN (20 CM) - X6

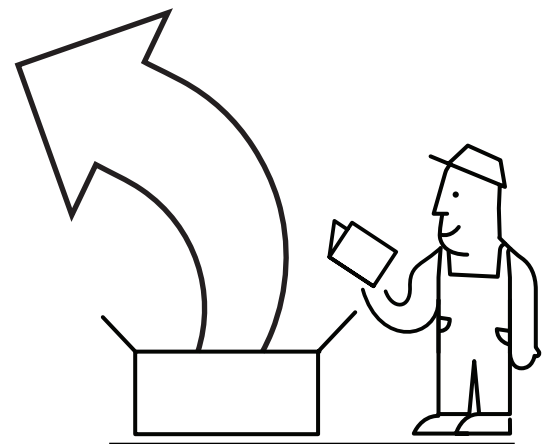

PRODUCT DIMENSIONS

DIMENSIONS DU PRODUIT

DIMENSIONES DEL PRODUCTO

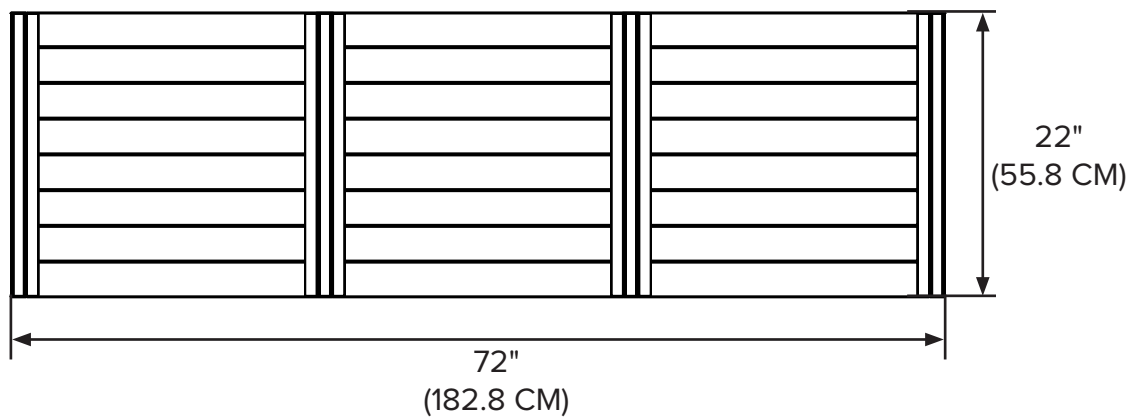
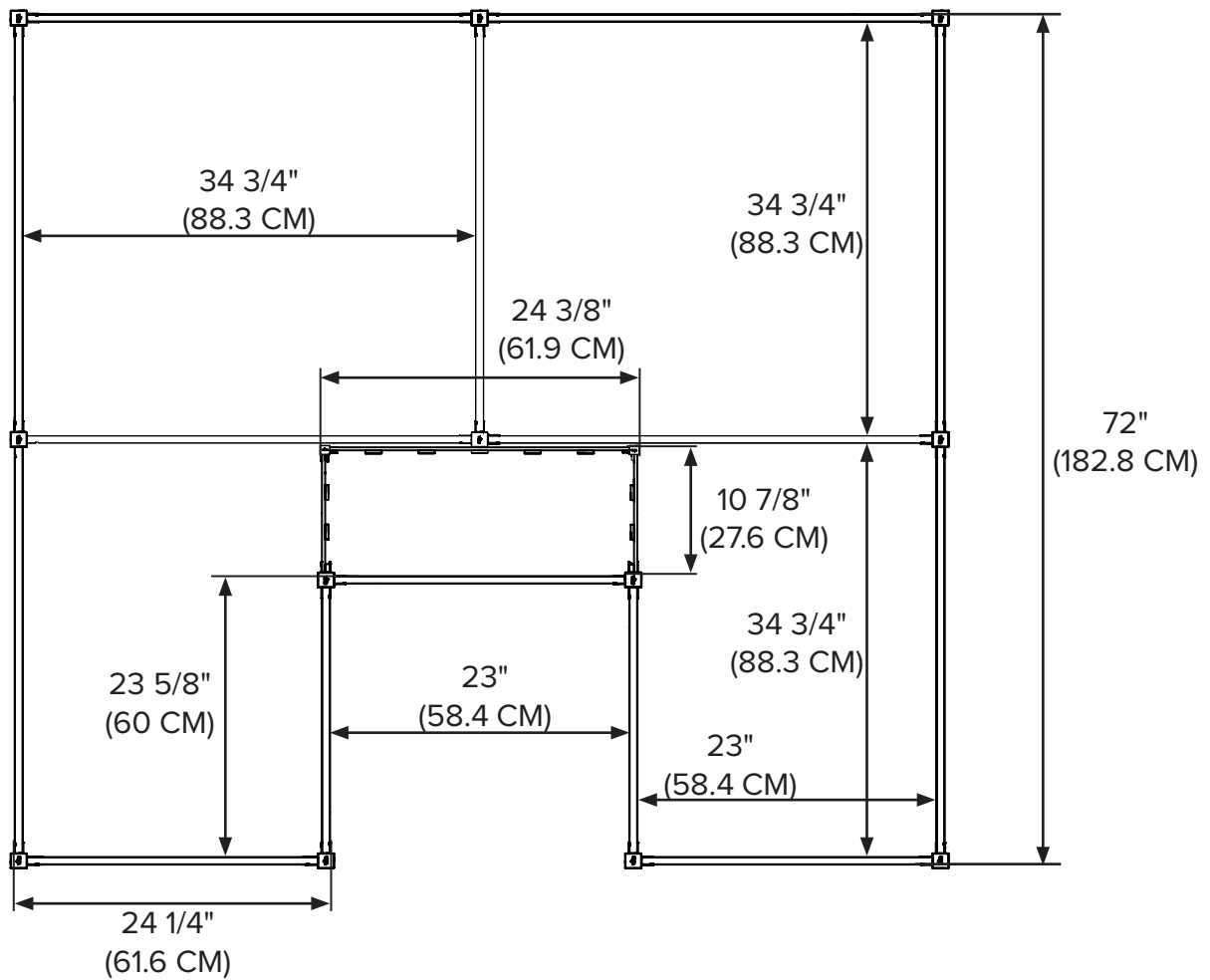

1

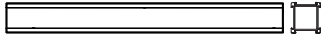
17018 - x11 

17020 - x11 

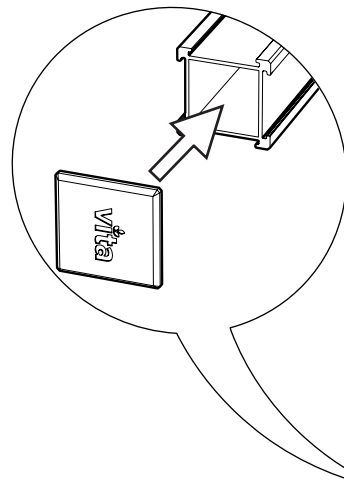

x11

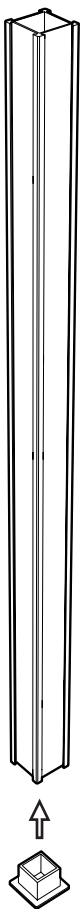

2

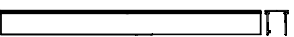
17019 - x12 

17031 - x42 

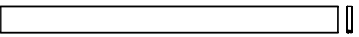
17030 - x6 

17030 x1

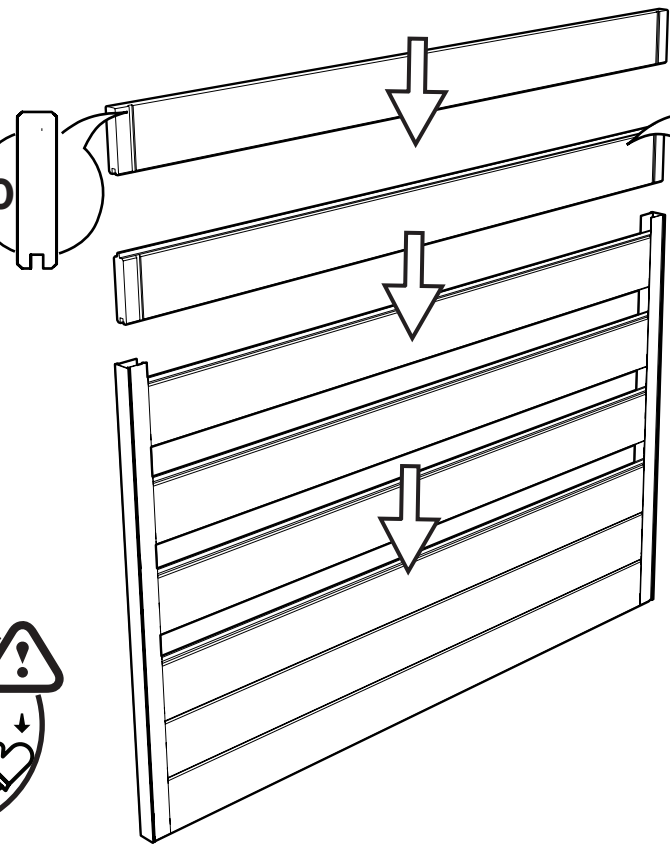

17031 x7

A x6





3

17032
x1

17033
x7

17033 - x35 

17032 - x5 

17019 - x10 

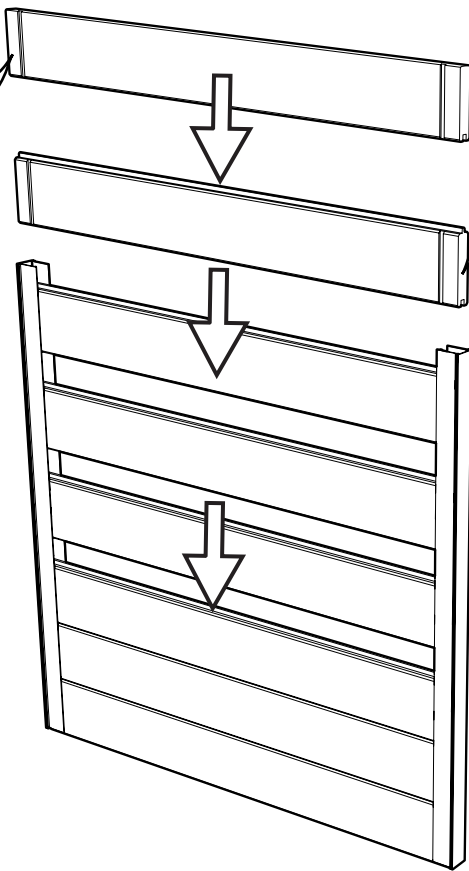

B x5

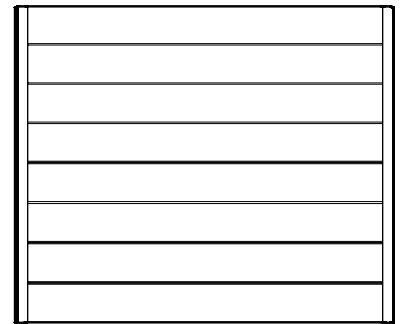

4

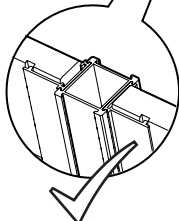
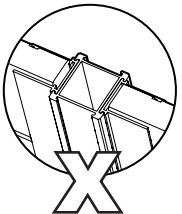
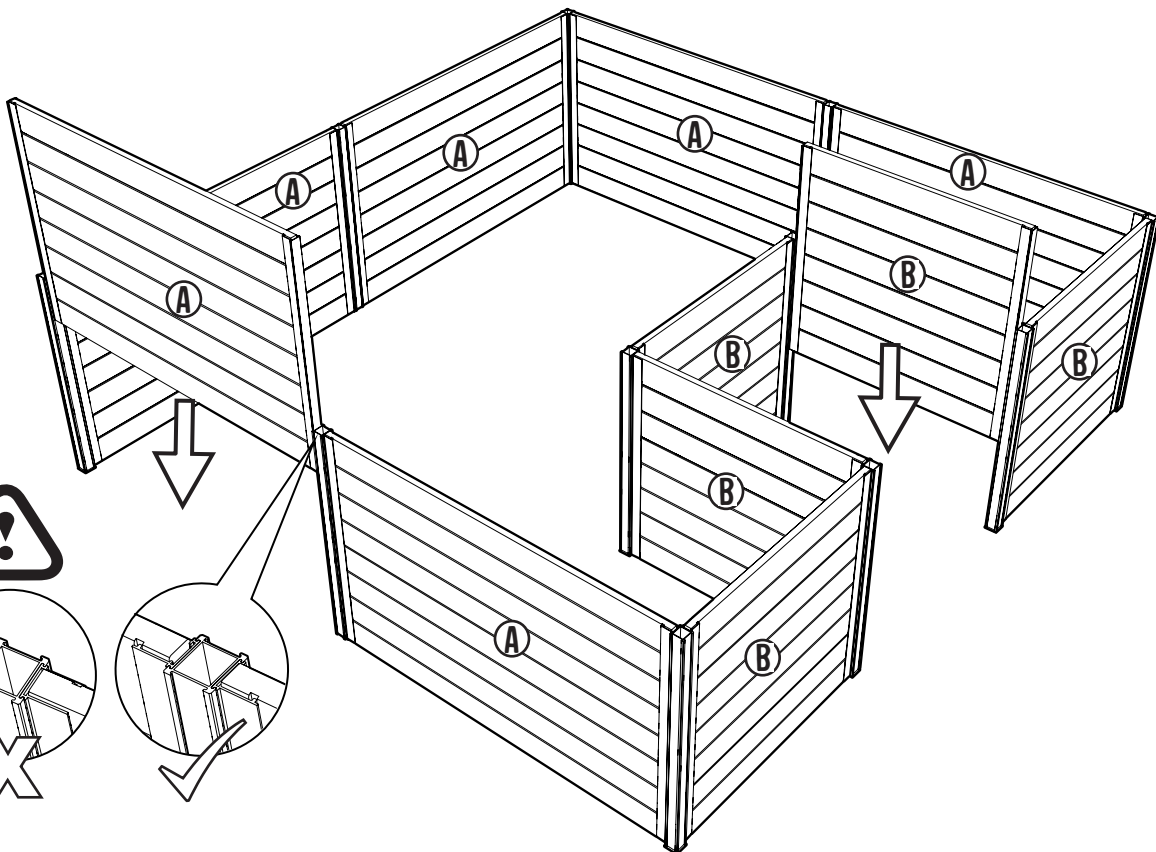

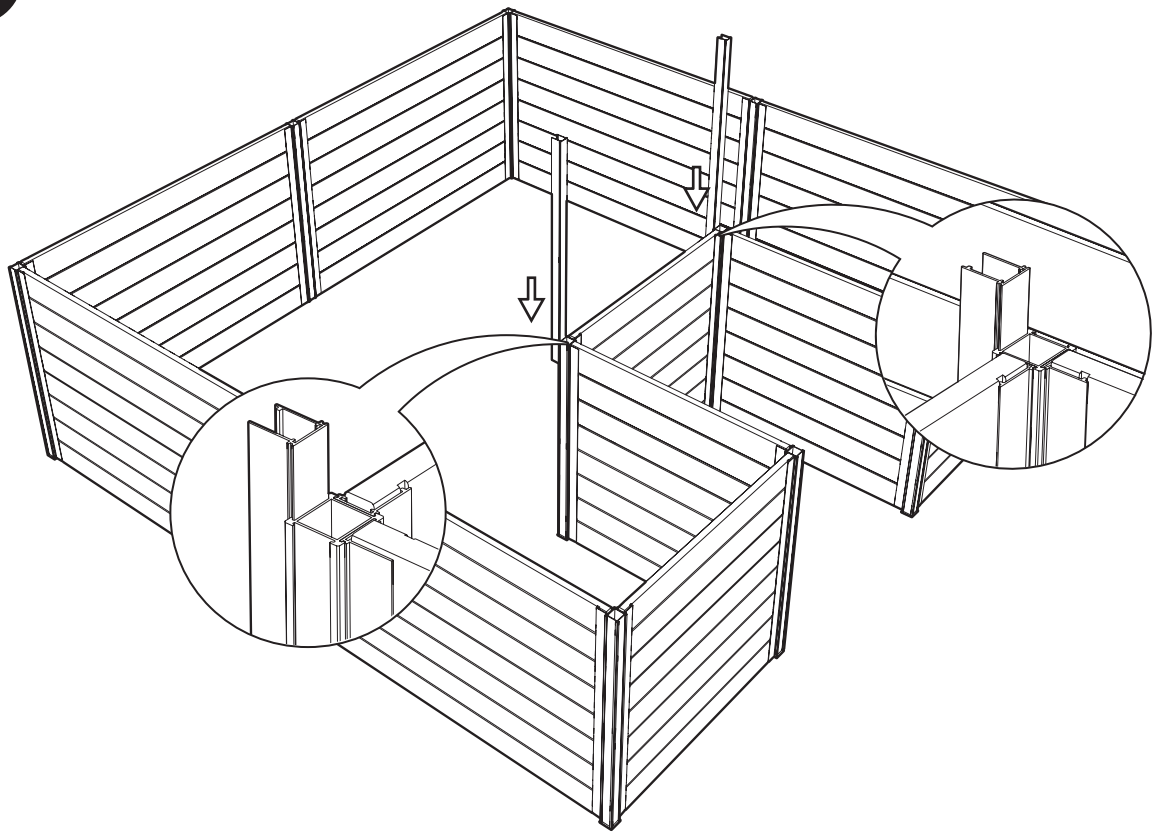

5

17019 - x2 

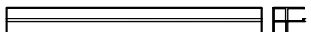
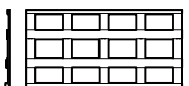

6

17021 - x2 
17034 - x2 
17022 - x2 

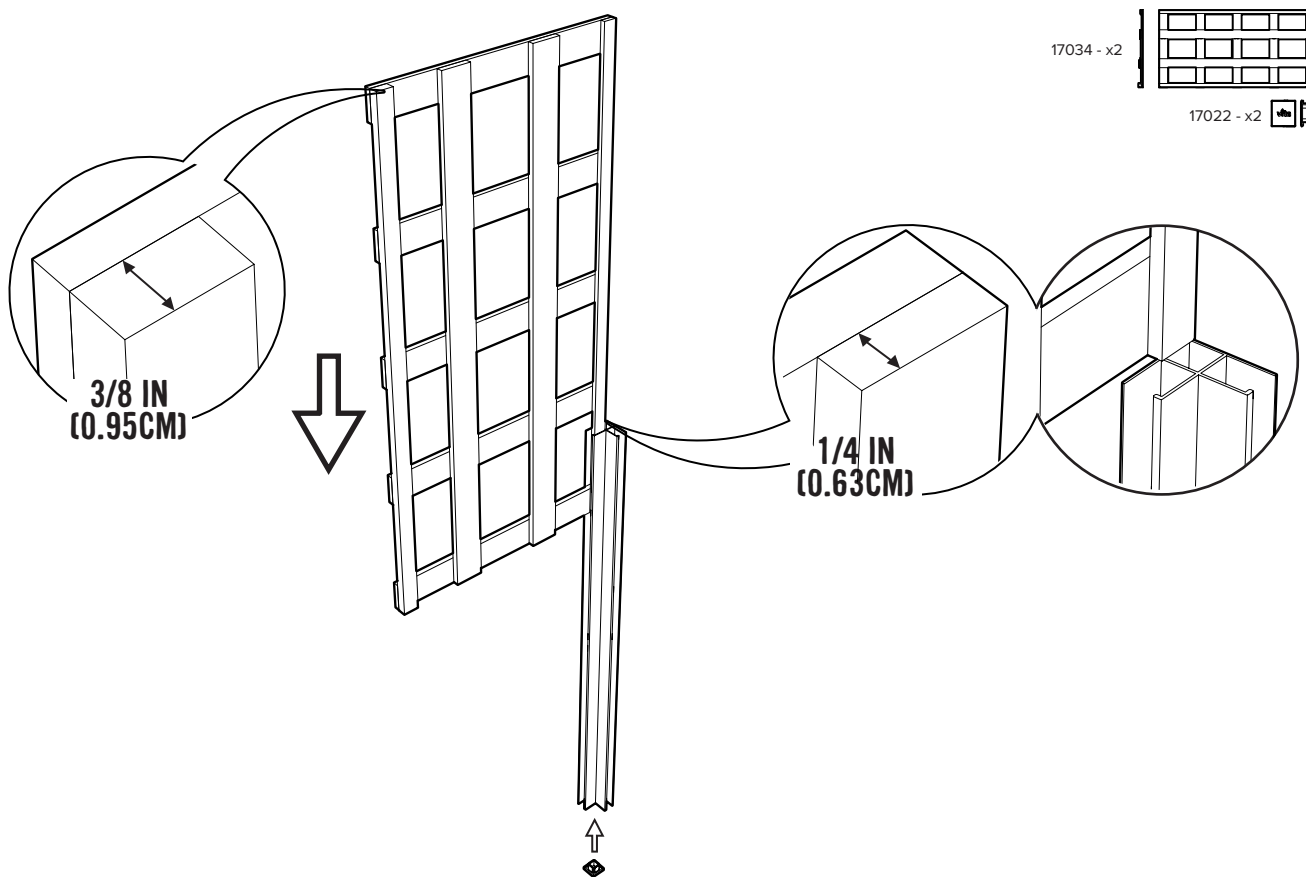

7

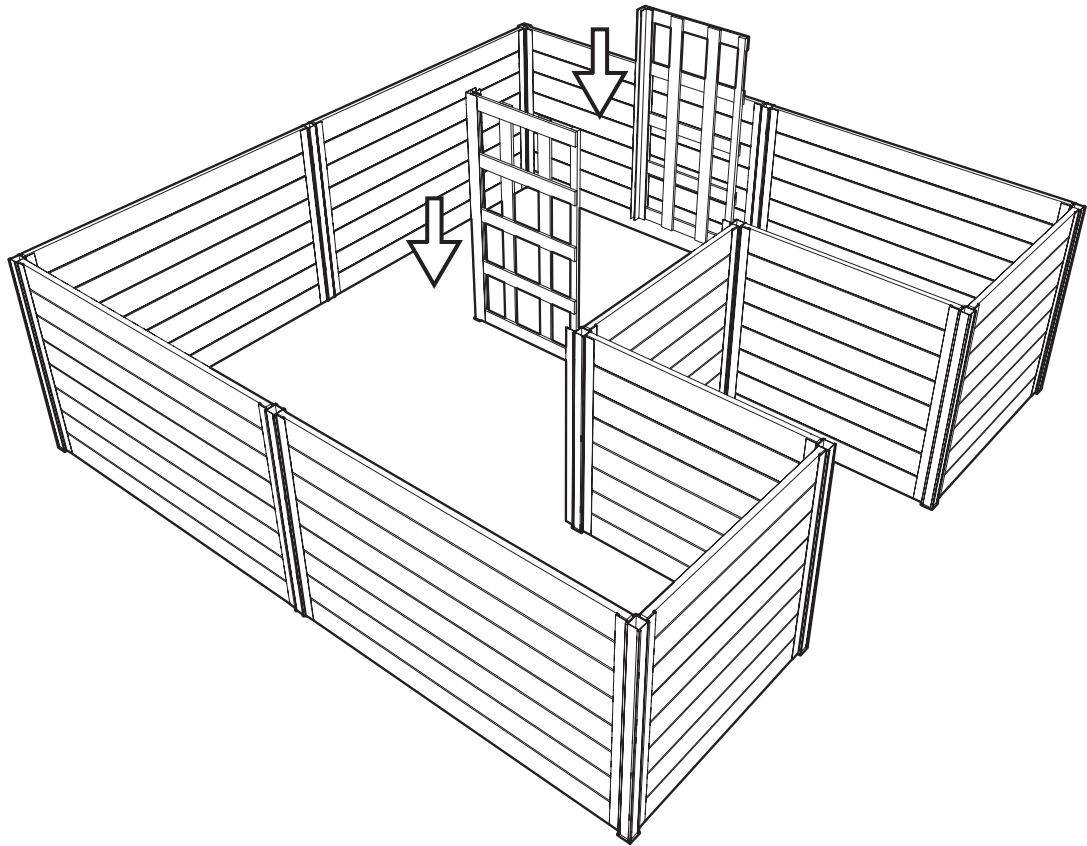

8

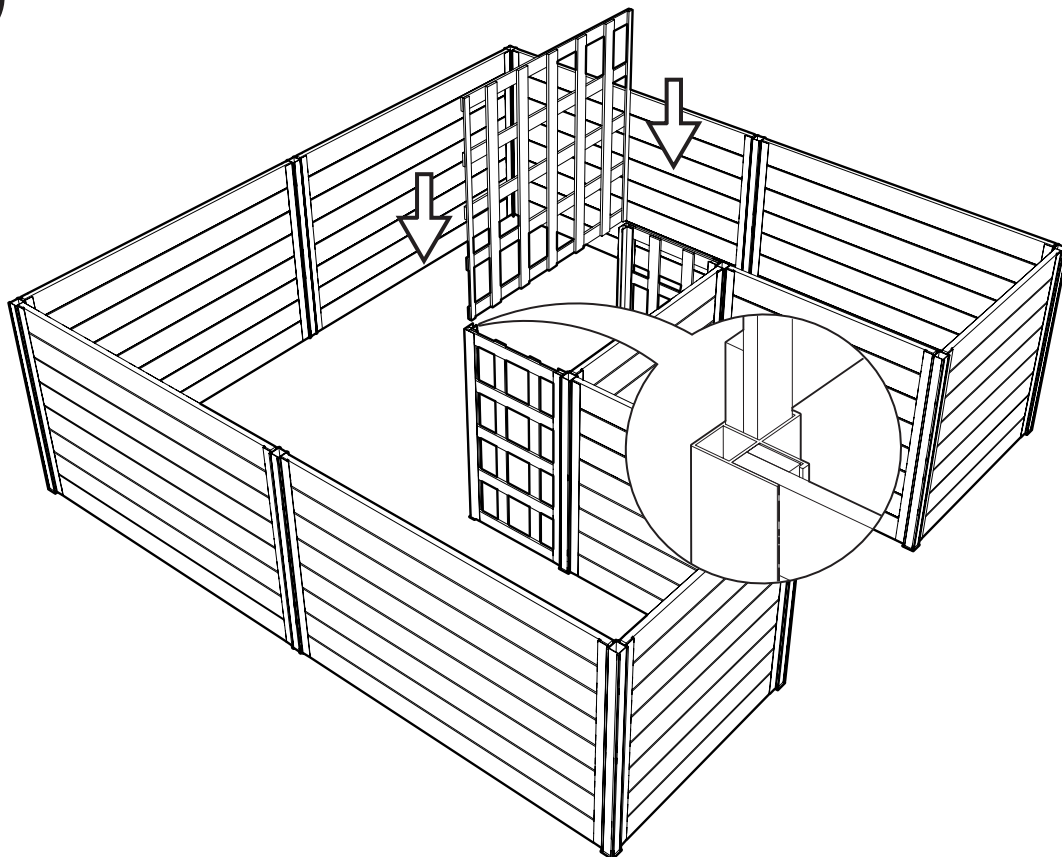

17035 - x1

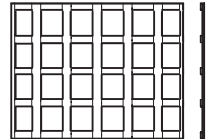

9

17037 - x3
17039 - x1
17020 - x1

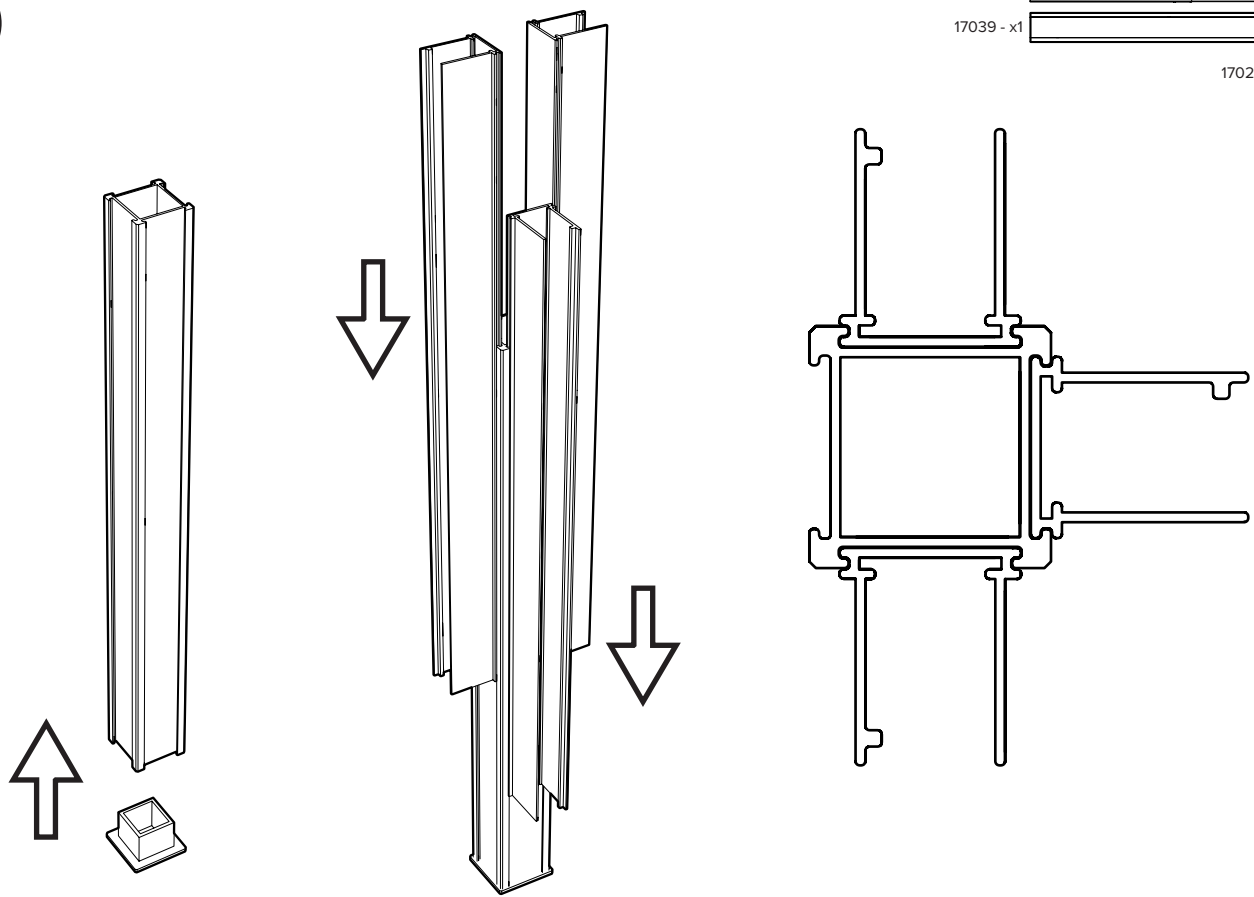

10

17037 - x3
17038 - x3

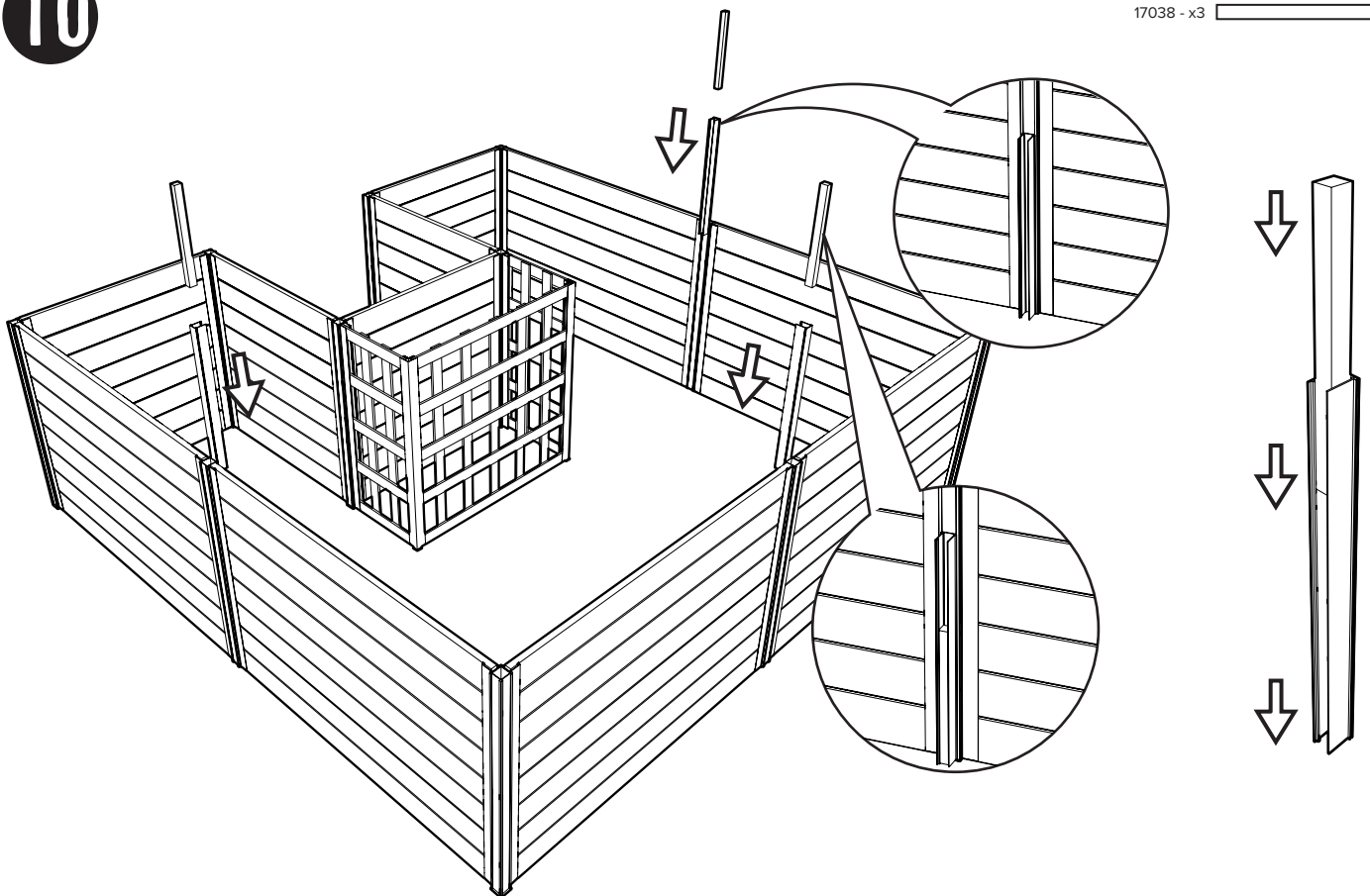

11

17030 - x3
17031 - x3
17038 - x3

17030
x6

17031
x7

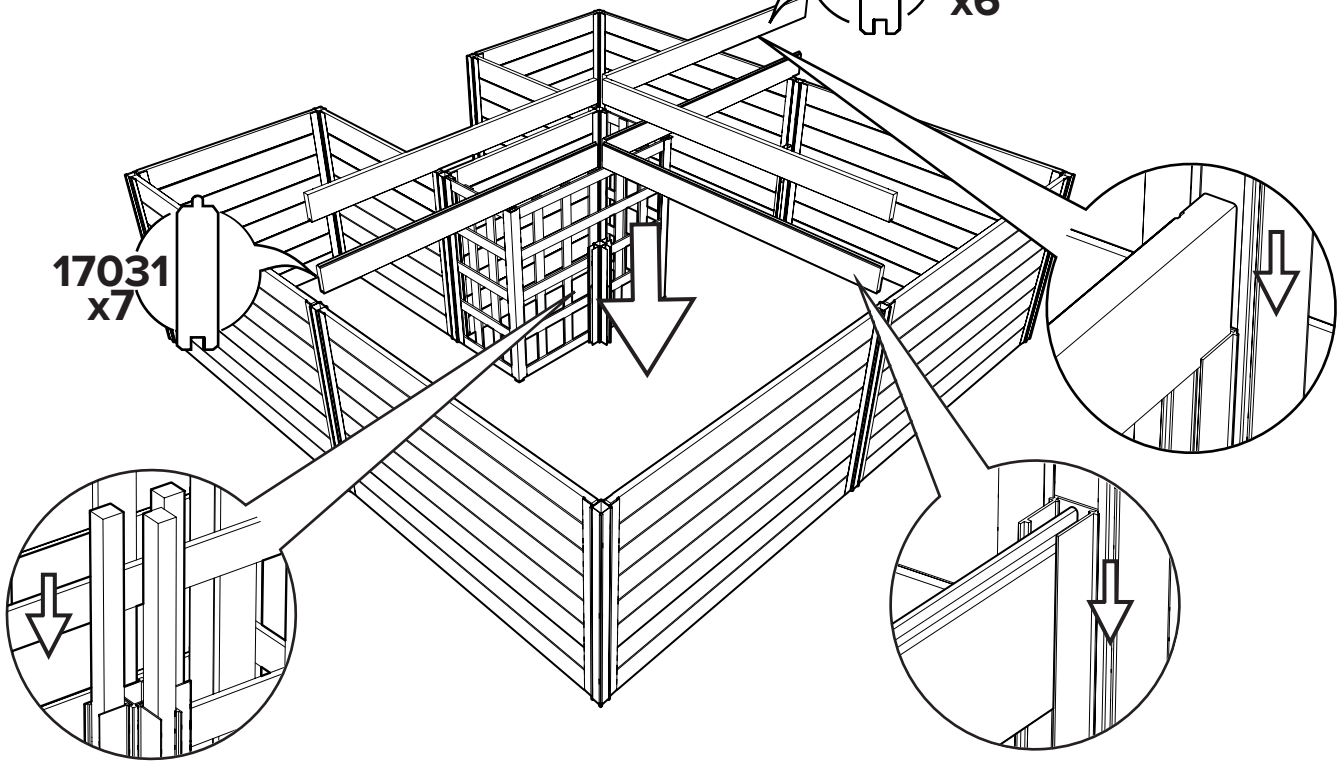

12

17022 - x2

17020 - x11

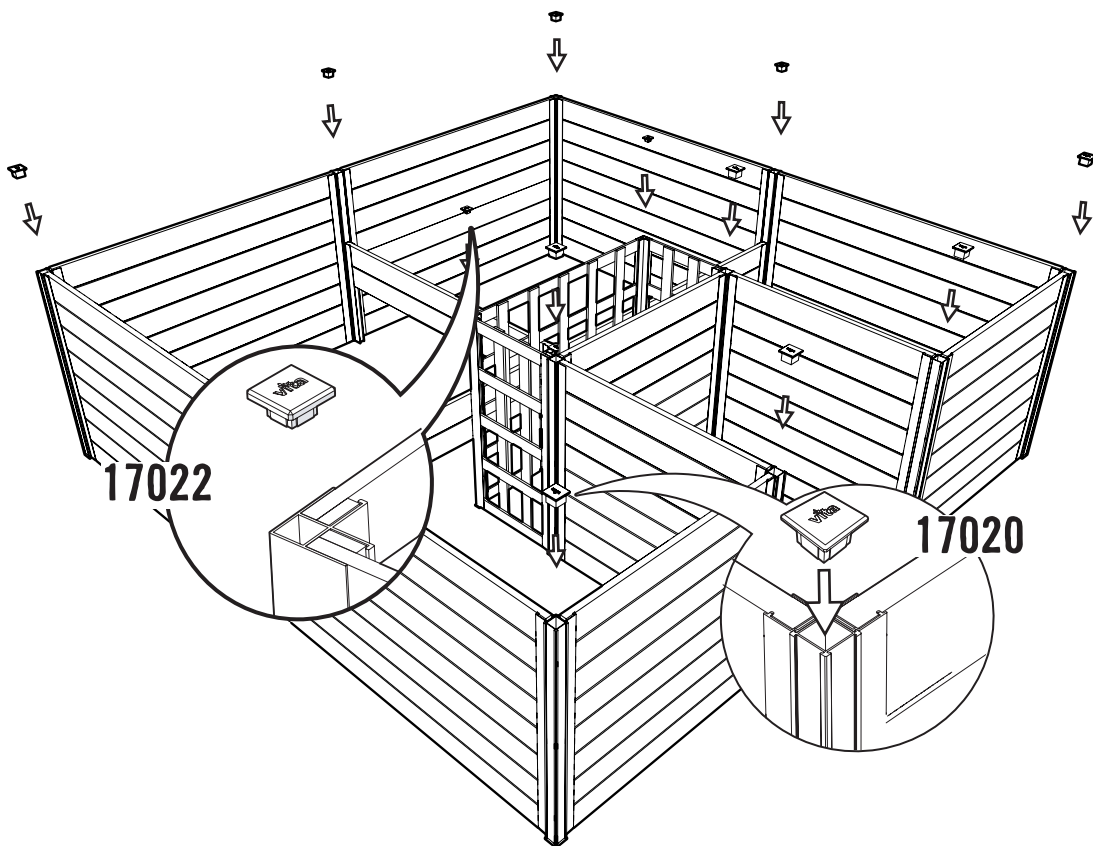

17022

17020

A.

FILL WITH SOIL!
 MIT ERDE FÜLLEN!
 RIEMPI CON TERRA!
 REMPLISSEZ-LE DE TERREAU!
 ILLENAR CON LA TIERRA!

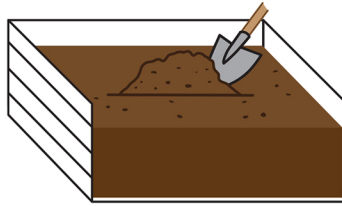

B.

MAKE YOUR OWN SOIL!
 PRODUZIEREN SIE EIGENE ERDE!
 PRODUCI LA TUE TERRA!
 CRÉÉZ VOTRE PROPRE TERREAU!
 IGREA TU PROPRIA TIERRA!

1

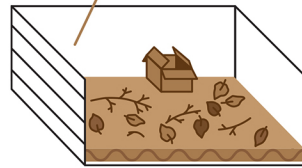

2

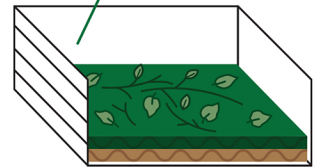

3

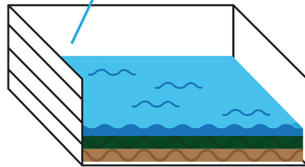

4

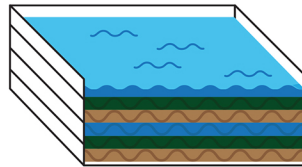

5

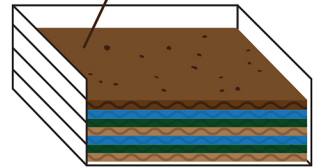

CARBON | CARBONE | CARBÓN
 NITROGEN | AZOTE | NITRÓGENO

