



URBANA

# MODERN TRELLIS

TREILLIS MODERNE  
ENREJADO MODERNO

## VT17531

ESPRESSO  
ESPRESSO  
ESPRESSO

## VT17631

SLATE  
ARDOISE  
PIZARRA

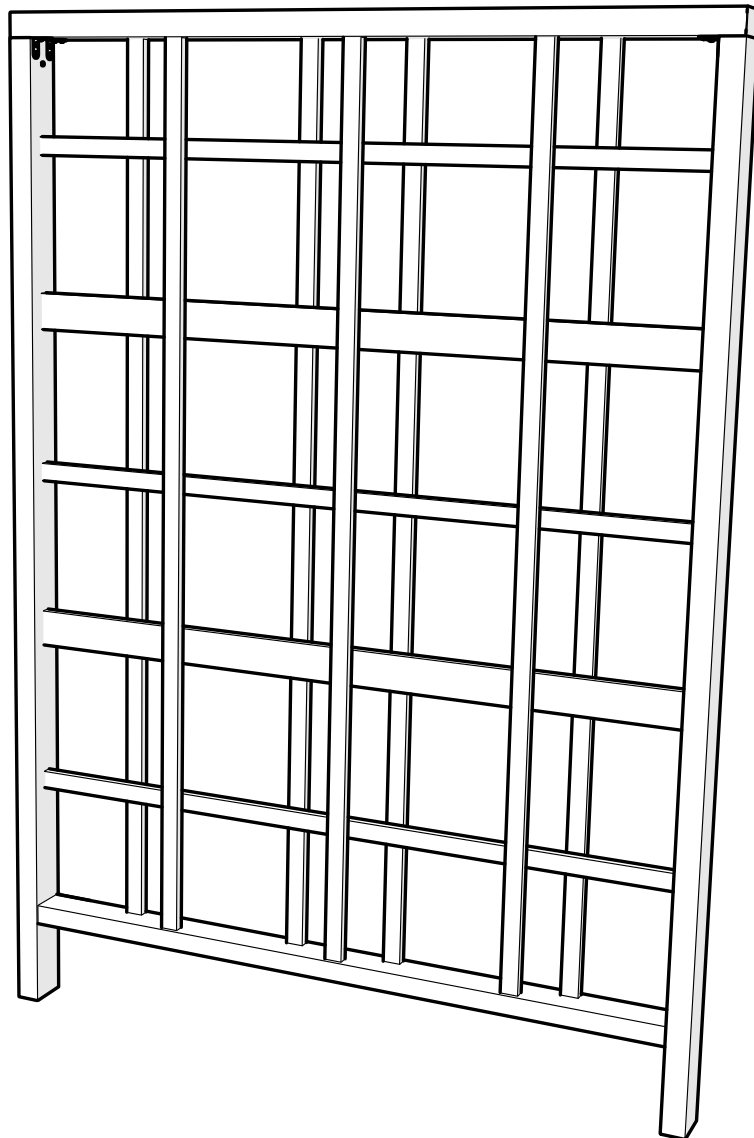

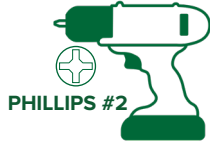

REQUIRED TOOLS AND MATERIALS (NOT INCLUDED)  
OUTILS ET MATÉRIAUX REQUIS (NON INCLUS)  
HERRAMIENTAS Y MATERIALES REQUERIDOS (NO INCLUIDOS)



HELLO@WEAREVITA.COM



VISIT [WWW.WEAREVITA.COM](http://WWW.WEAREVITA.COM)  
CLICK 'CHAT'



1-800-282-9346  
MONDAY - FRIDAY | 8AM - 5PM EST



**PRODUCT DIMENSIONS**

**DIMENSIONS DU PRODUIT**

**DIMENSIONES DEL PRODUCTO**

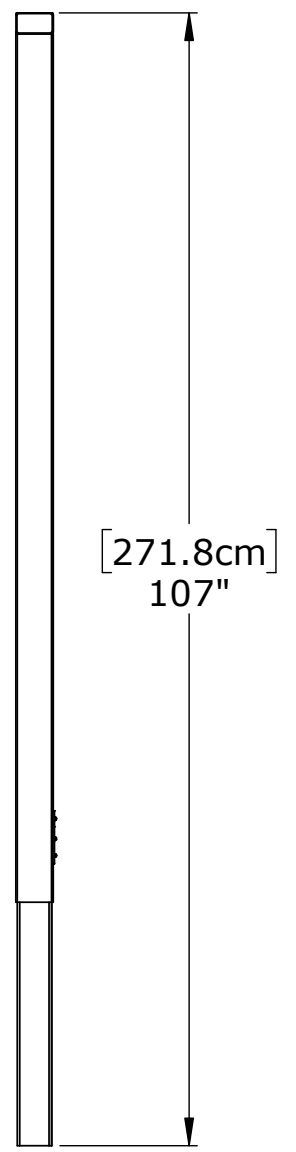
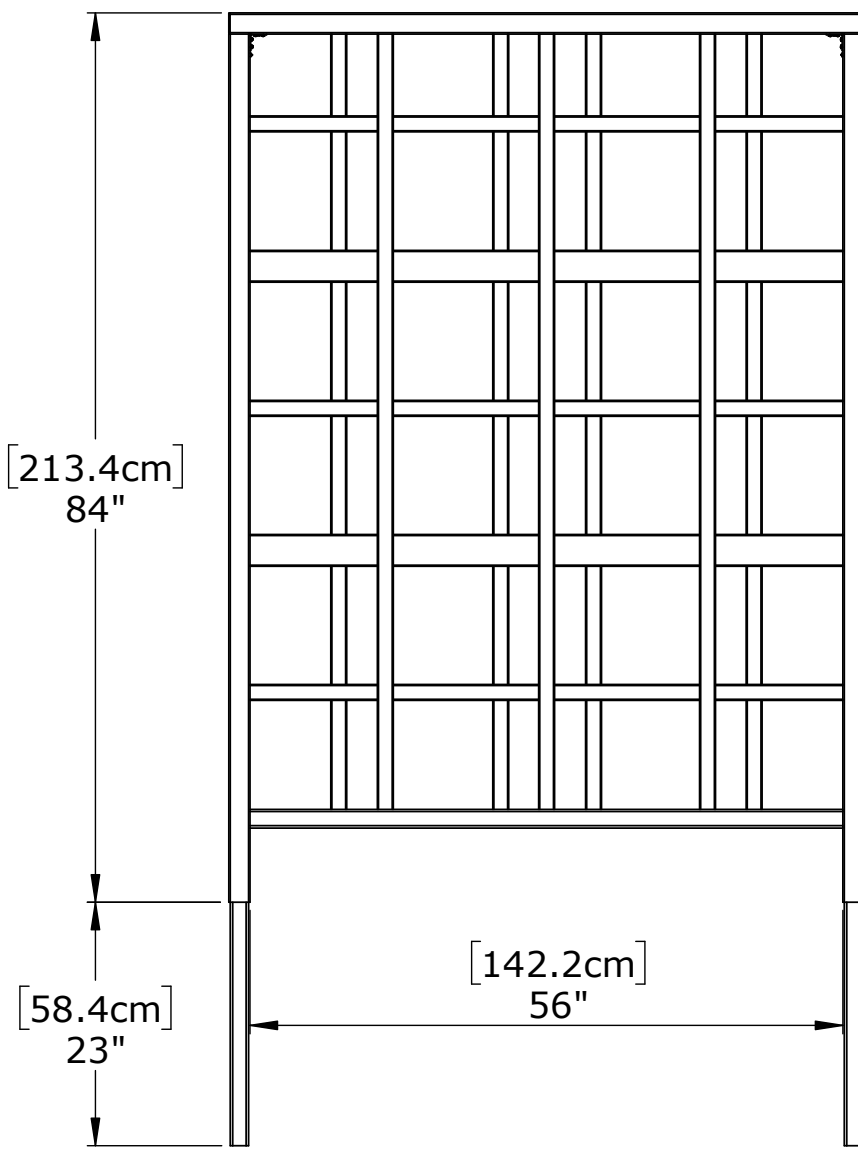
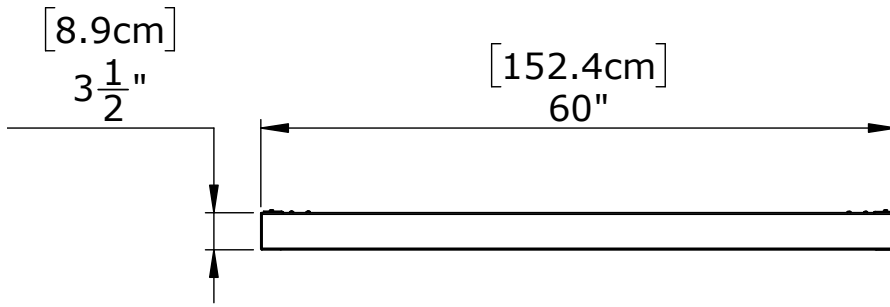

# PARTS LIST

LISTE DES PIÈCES  
LISTADO DE PIEZAS

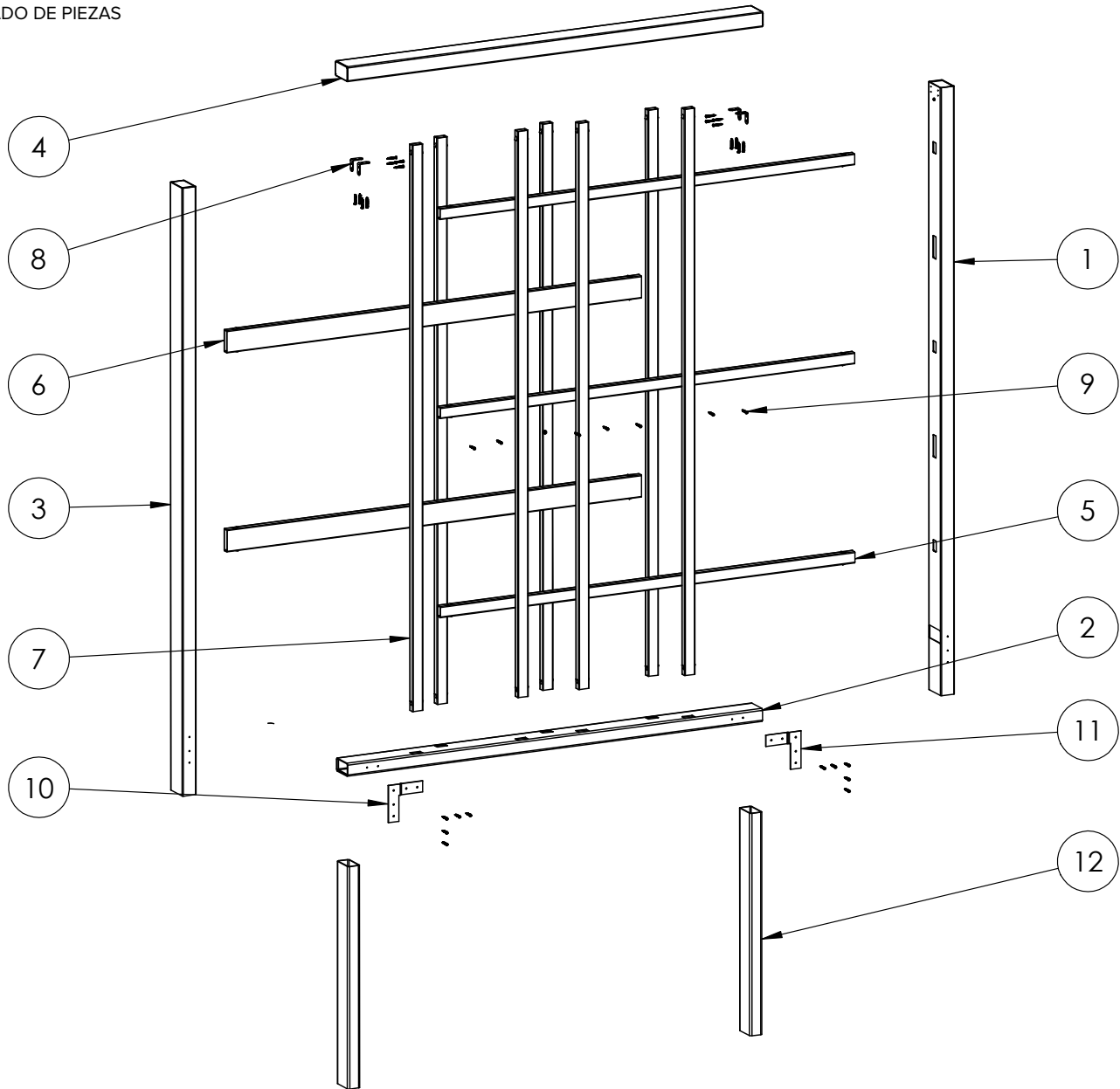

ITEM NO.	Part Number (Slate)	Part Number (Espresso)	Description	Dimensions	QTY.
1	16225	15225	Right Post	82" (208.3 cm)	1
2	16211	15211	Bottom Rail	59 7/8" (151.8cm)	1
3	16209	15209	Left Post	82" (208.3cm)	1
4	16210	15210	Top Rail	59 7/8" (151.9cm)	1
5	16213	15213	Slim Horizontal Beam	59 7/8" (151.9cm)	3
6	16214	15214	Broad Horizontal Beam	59 7/8" (151.9cm)	2
7	16212	15212	Vertical Beam	76 3/4" (195cm)	7
8	16217	15217	Corner Bracket	1 5/8" x 5/8" (4cm x 1.7cm)	4
9	20080	20080	Self Tapping Screw	M4.2x32cm (1 1/4")	33
10	16226	15226	Left L-Bracket	5" x 5" (12.7cm x 12.7cm)	1
11	16227	15227	Right L-Bracket	5" x 5" (12.7cm x 12.7cm)	1
12	16215	15215	Ground Stake	30" (76.2cm)	2

# PARTS LIST

LISTE DES PIÈCES  
LISTADO DE PIEZAS



1x

1



1x

2



1x

3



1x

4



3x

5

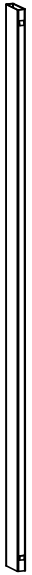

2x

6



7x

7

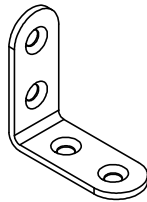

4x

8

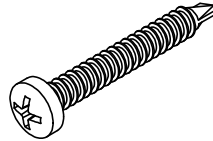

33x

9

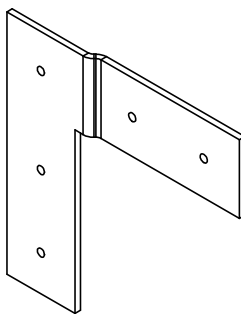

1x

10

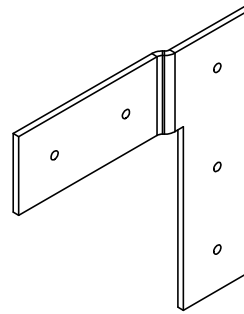

1x

11

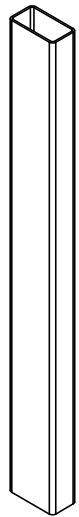

2x

12

## COMPLETELY UNPACK AND TAKE INVENTORY OF PARTS BEFORE BEGINNING

DEBALLEZ COMPLETEMENT ET FAITES L'INVENTAIRE DES PIÈCES AVANT DE COMMENCER

ANTES DE COMENZAR, DESEMBALE COMPLETEMENTE EL PRODUCTO Y REALICE UN INVENTARIO DE LAS PIEZAS

# 0

## PREPARE TRIMMED LUMBER GROUND STAKES (OPTIONAL FOR STRONGER INSTALLATION)

PREPAREZ DES PIQUETS DE BOIS TAILLES  
(EN OPTION POUR UNE INSTALLATION PLUS SOLIDE)  
RECORTE ESTACAS DE MADERA PARA AFIRMAR AL SUELO  
(OPCIONAL PARA UNA INSTALACIÓN MÁS FUERTE)



**2X4X6 LUMBER**  
(1 1/2" X 3 1/2" X 6')



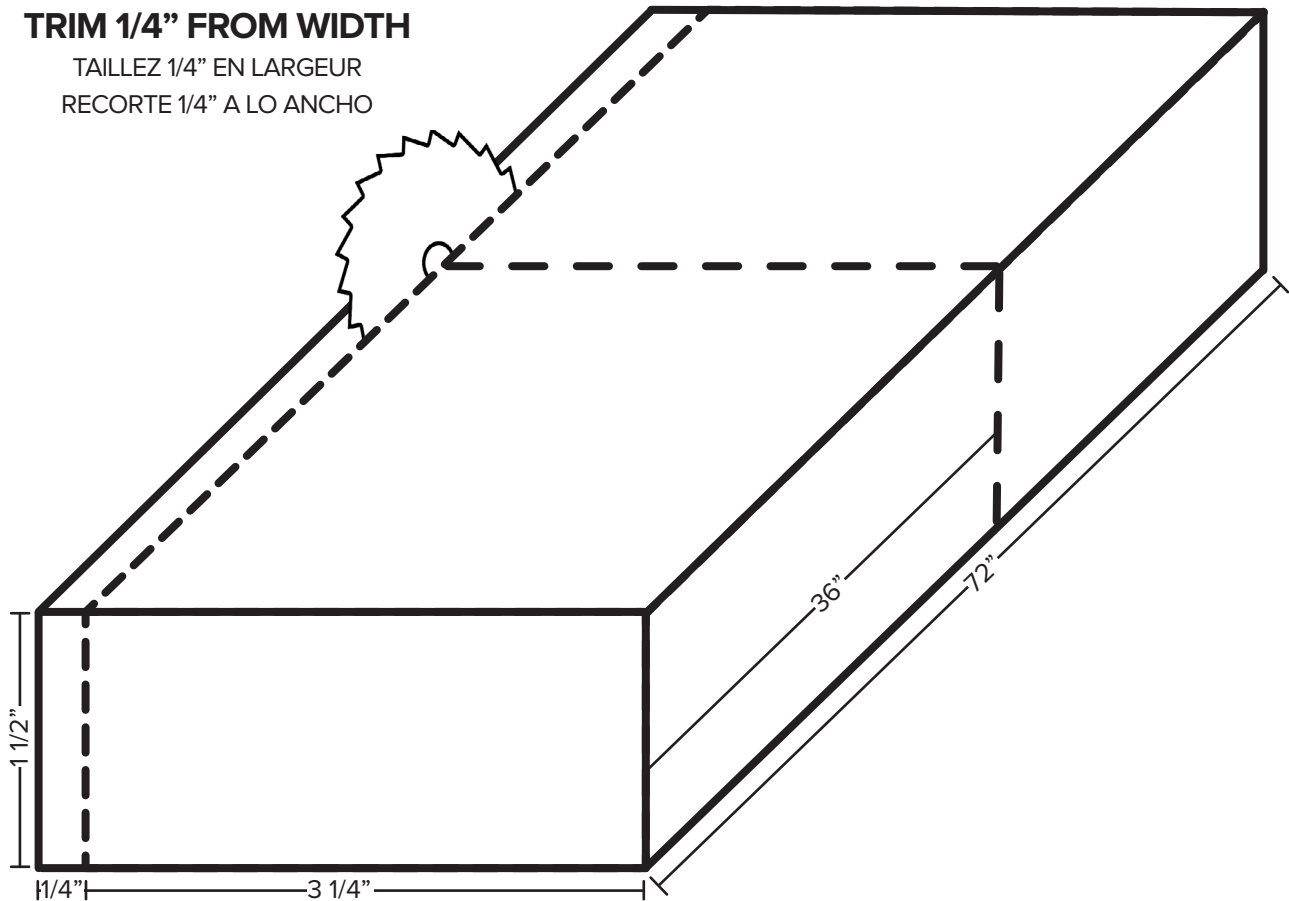

### TRIM 1/4" FROM WIDTH

TAILLEZ 1/4" EN LARGEUR  
RECORTE 1/4" A LO ANCHO



# CONNECT THE HORIZONTAL BEAMS AND BOTTOM RAIL TO THE VERTICAL POSTS

CONNECTEZ LES POUTRES HORIZONTALES ET LE RAIL INFÉRIEUR AUX POTEAUX VERTICAUX  
EMPALME LAS VIGAS HORIZONTALES Y EL RIEL INFERIOR CON LOS POSTES VERTICALES

-  ① x1
-  ② x1
-  ③ x1
-  ⑤ x3
-  ⑥ x2

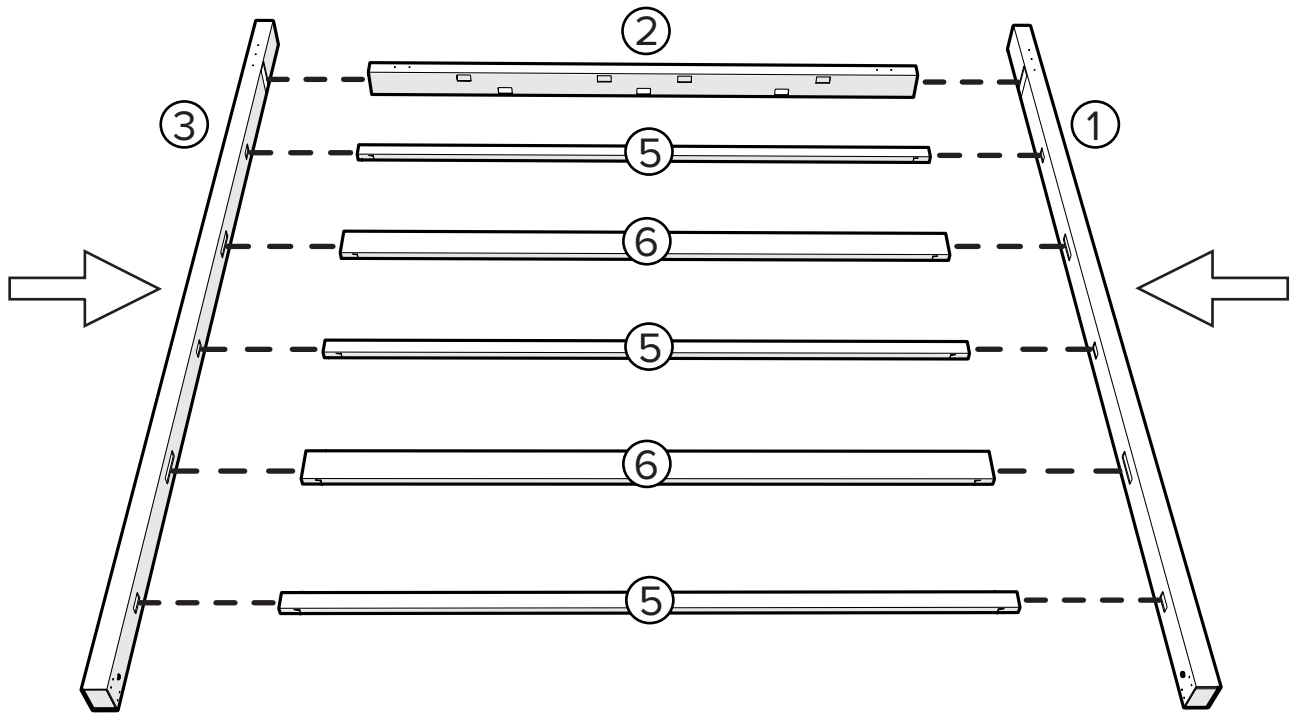
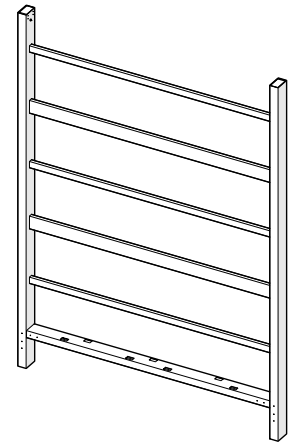

## 2 CONNECT THE VERTICAL BEAMS TO THE BOTTOM AND TOP RAILS

CONNECTEZ LES POUTRES VERTICALES AUX RAILS INFÉRIEURS ET SUPÉRIEURS  
EMPALME LAS VIGAS VERTICALES CON LOS RIELES INFERIOR

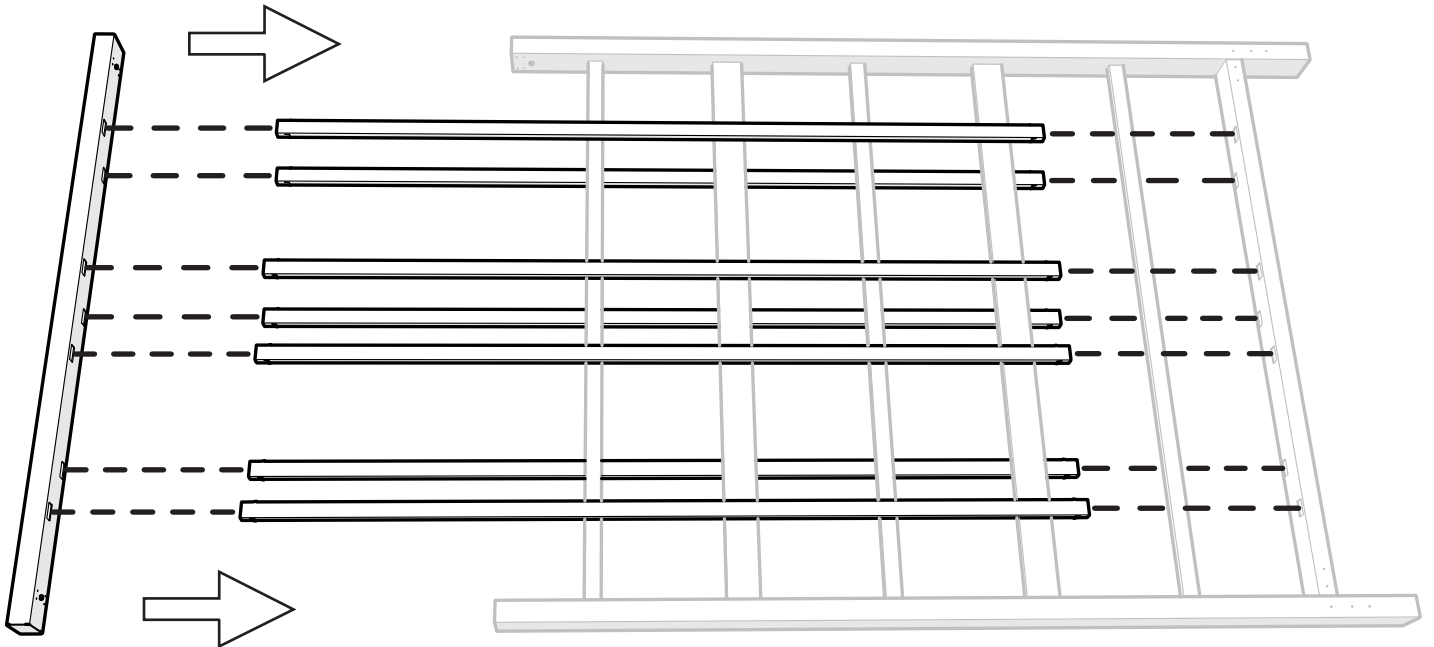
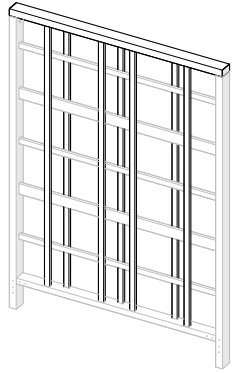
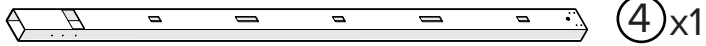



# 3 SECURE THE CORNER BRACKETS TO THE TOP RAIL AND VERTICAL POSTS

CONNECTEZ LE RAIL SUPÉRIEUR AUX POTEAUX VERTICAUX  
EMPALME EL RIEL SUPERIOR CON LOS POSTES VERTICALES

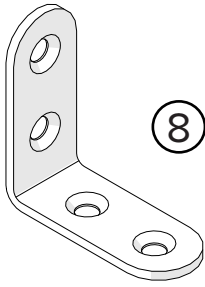

8 x 4

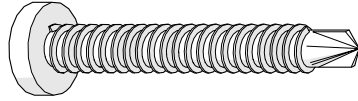

9 x 23

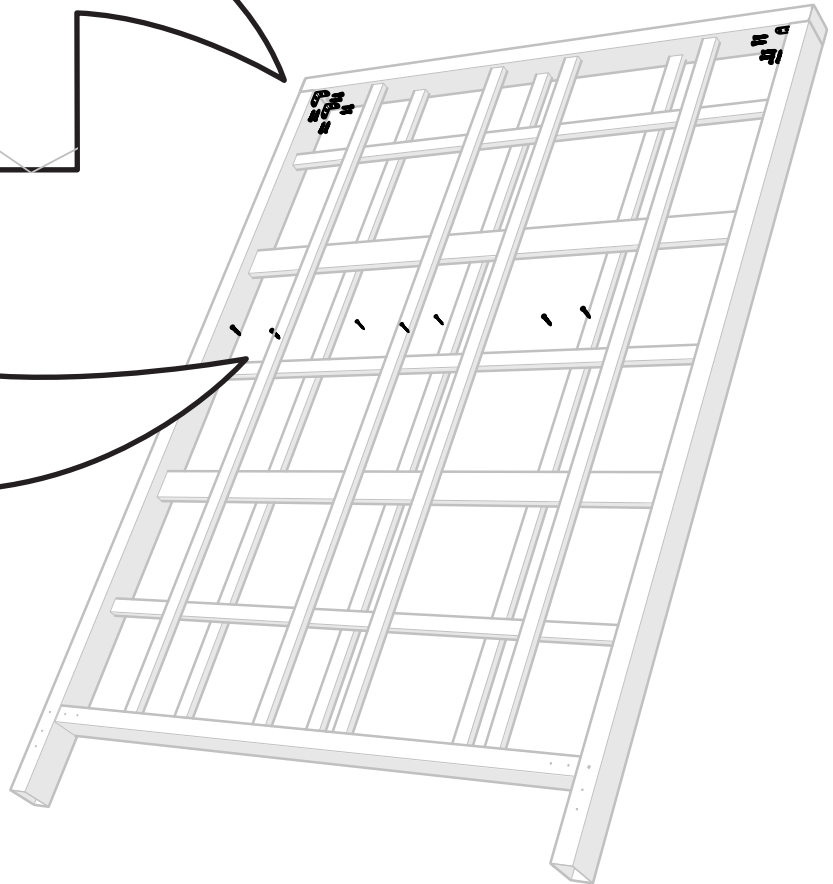
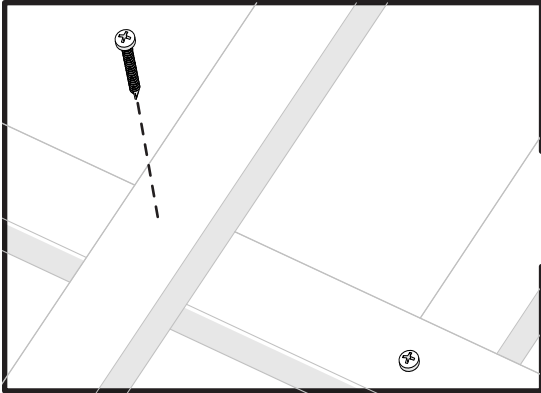
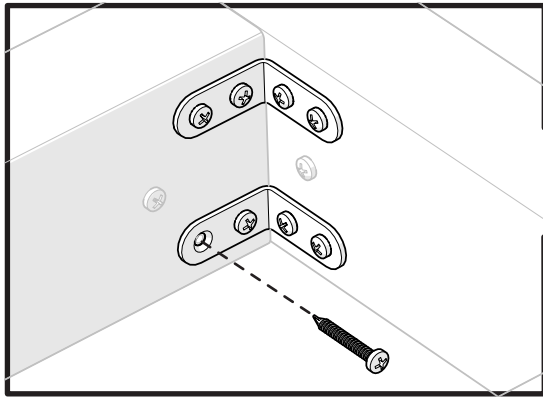
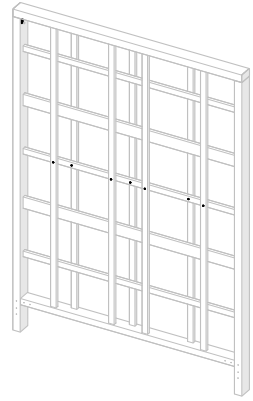

# 4 CONNECT THE INCLUDED PVC OR FABRICATED LUMBER GROUND STAKES TO THE VERTICAL POSTS THEN SECURE THE L-BRACKETS

CONNECTEZ LES PIQUETS EN PVC INCLUS OU CEUX PREPARES PAR VOUS AUX POTEAUX VERTICAUX PUIS FIXEZ LES ATTACHES EN L

UNA LAS ESTACAS DE PVC INCLUIDAS O LAS DE MADERA FABRICADAS POR USTED A LOS POSTES VERTICALES Y LUEGO FIJE LOS SOPORTES EN L

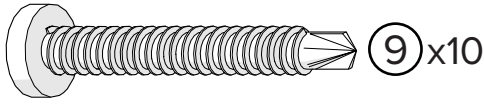
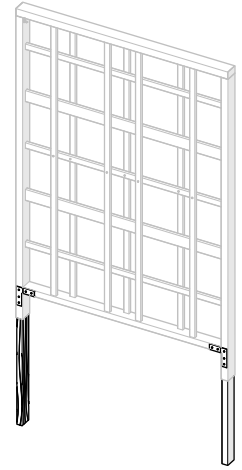

9x10

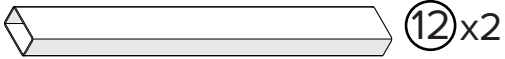

12x2

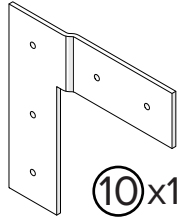

10x1

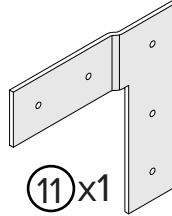

11x1

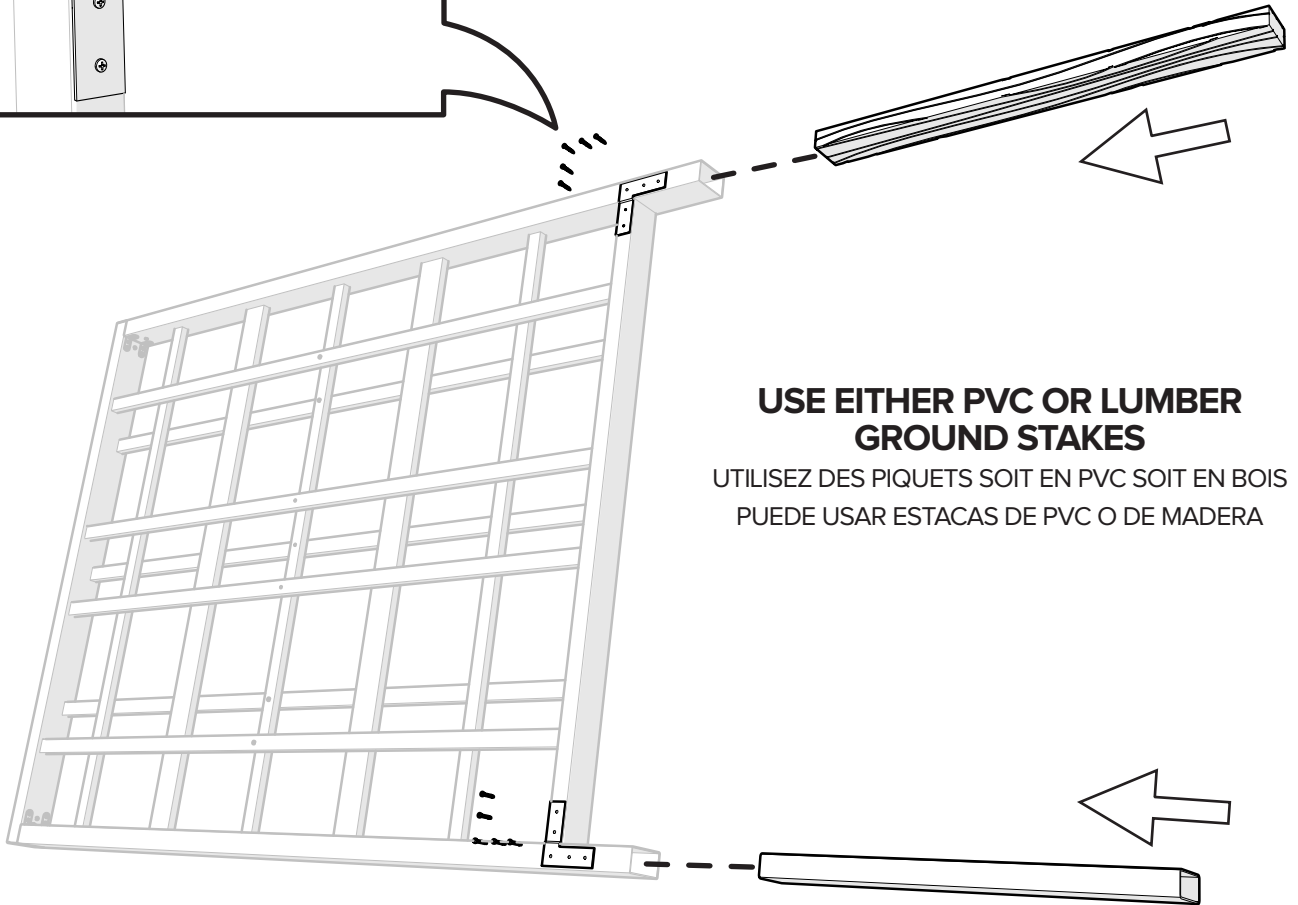
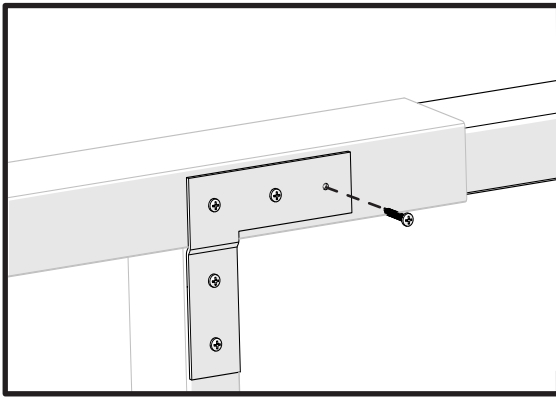

**USE EITHER PVC OR LUMBER GROUND STAKES**

UTILISEZ DES PIQUETS SOIT EN PVC SOIT EN BOIS  
PUEDE USAR ESTACAS DE PVC O DE MADERA



# 5 INSTALL THE TRELLIS (WALL MOUNT RECOMMENDED)

INSTALLEZ THE TREILLIS (POSITION RECOMMANDEE CONTRE UN MUR)  
INSTALE EL ENREJADO (SE RECOMIENDA MONTARLO EN UNA PARED)

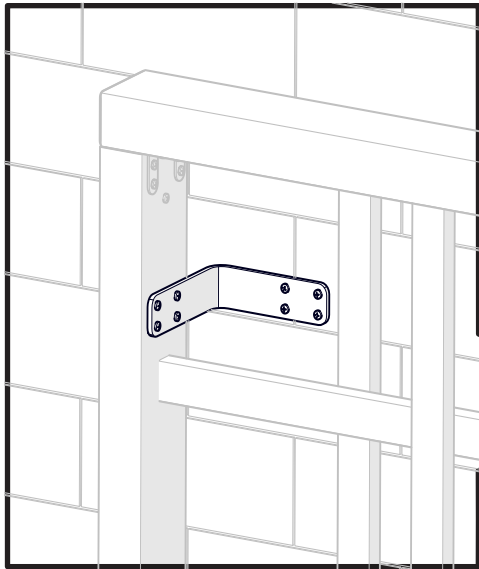

## FASTEN TO WALL (HARDWARE NOT INCLUDED)

ATTACHEZ AU MUR (FIXATION NON FOURNIE)  
FÍJELO A LA PARED (MATERIALES NO INCLUIDOS)

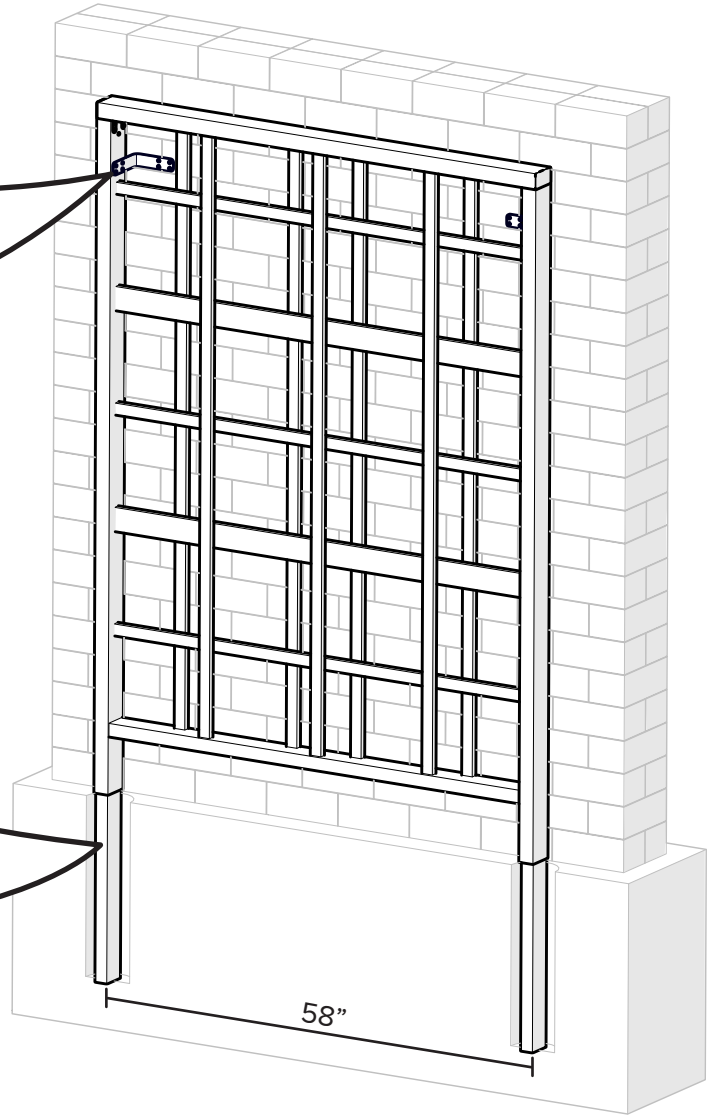
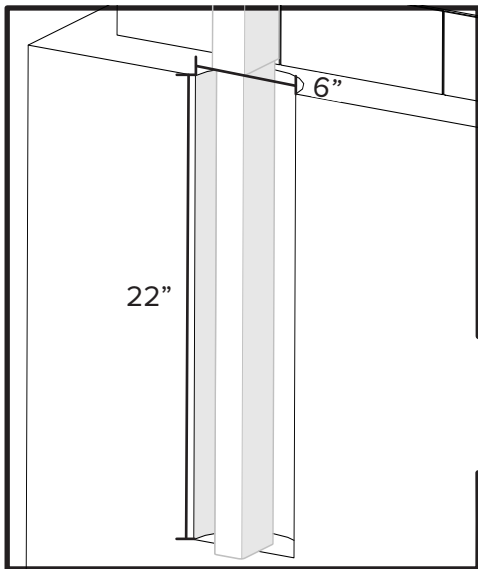

## DIG HOLES USING DIMENSIONS AND INSERT GROUND POSTS

CREUSEZ DES TROUS SELON LES DIMENSIONS ET  
INSEREZ LES POTEAUX DANS LE SOL  
CAVE ORIFICIOS DE LAS DIMENSIONES INDICADAS  
E INSERTE LOS POSTES

## FILL WITH CEMENT TO SECURE

GARNISSEZ DE CIMENT POUR BIEN FIXER LE TOUT  
RELLENE CON CEMENTO PARA ASEGURAR EL  
ENREJADO

