



ASSEMBLY GUIDE
GUIDE DE MONTAGE
GUÍA DE MONTAJE

URBANA

6X6 KEYHOLE GARDEN

JARDIN DE TROU DE SERRURE 6X6

JARDÍN DE LA CERRADURA 6X6

VT17507 / VT17607

ESPRESSO

SLATE

ESPRESSO

ARDOISE

ESPRESSO

PIZARRA

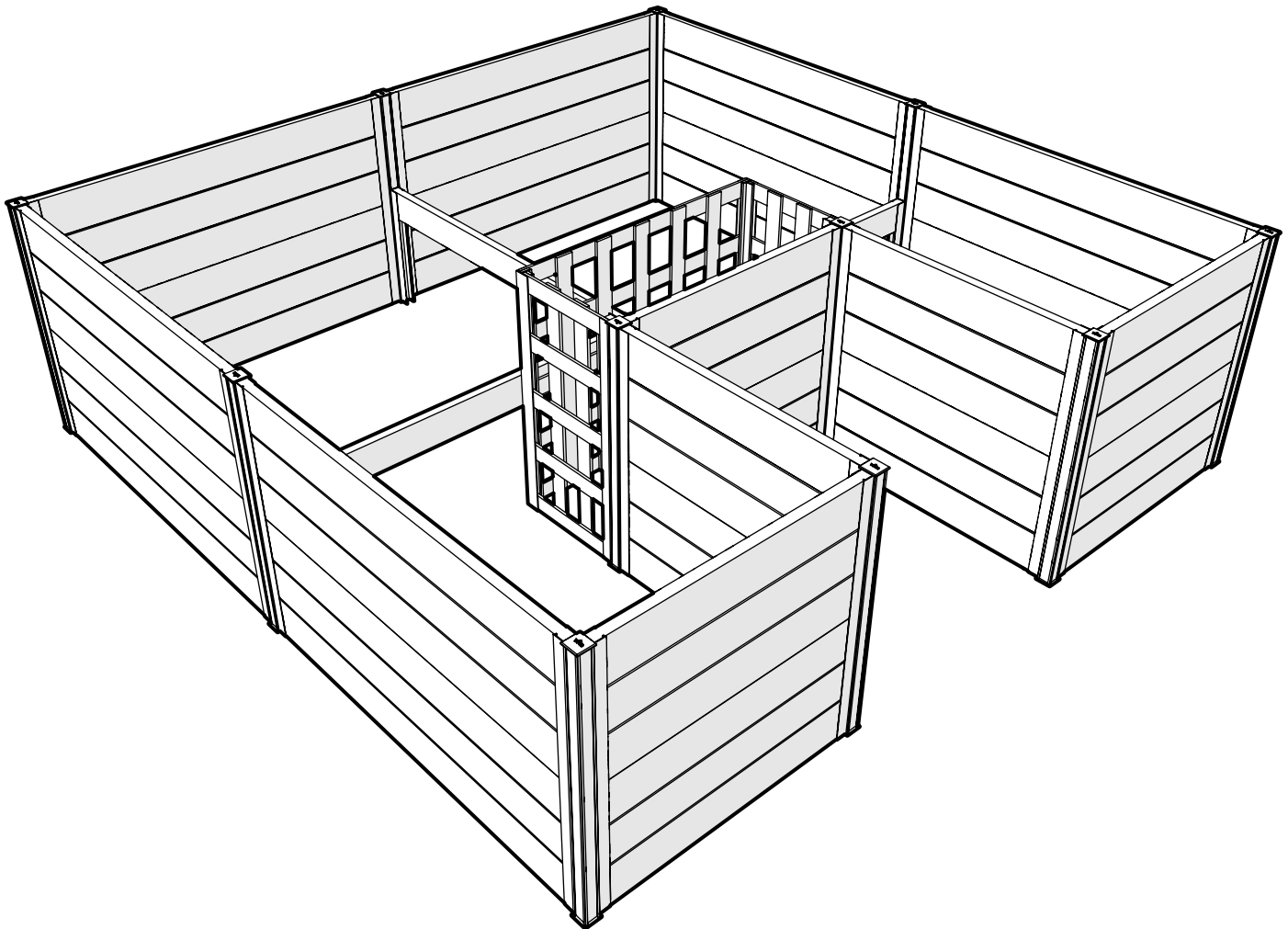

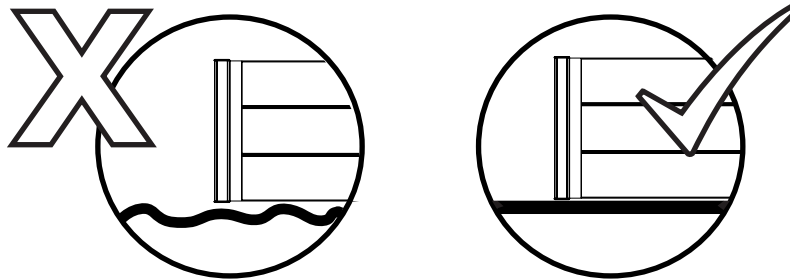
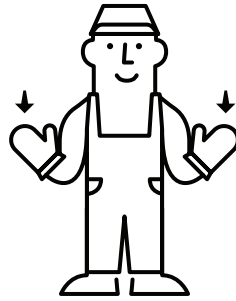
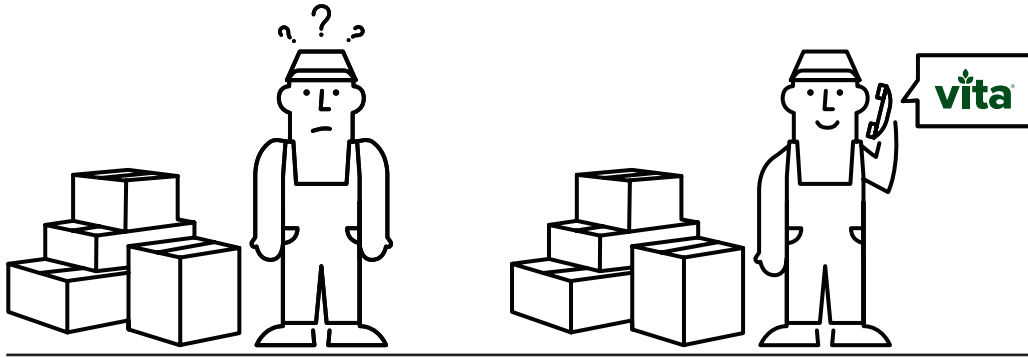

☎ 1-800-282-9346



HELLO@WEAREVITA.COM



WWW.WEAREVITA.COM



8:00 AM - 4:00 PM EST



PARTS LIST LISTE DES PIÈCES LISTA DE PARTES

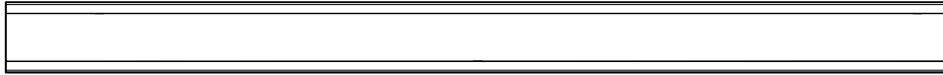

16002 - POST A - PUBLIER A - EXPONER A - 21 7/8" (55.5 CM) - **X11**



16200 - POST B - PUBLIER B - EXPONER B - 12 3/8" (31.5 CM) - **X1**



16037 - C-CHANNEL C - C-CHAÎNE C - C-CHANNEL C - 21 7/8" (55.5 CM) - **X24**



16201 - C-CHANNEL D - C-CHAÎNE D - C-CHANNEL D - 12 3/8" (31.5 CM) - **X6**

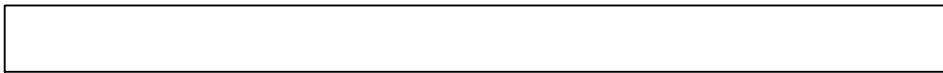

16235 - BASKET POST F - PUBLIER F - EXPONER F - 22" (55.8 CM) - **X2**

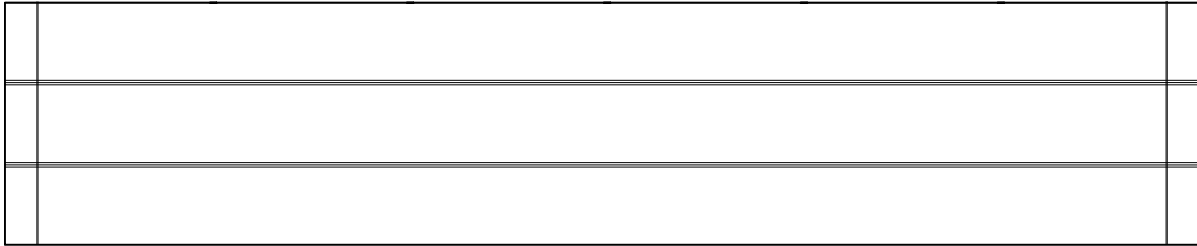

16203 - SLATE - ARDOISE - PIZARRA

15203 - ESPRESSO - EXPRESSO - ESPRESSO

BOARD F - PLANCHE F - TABLERO F

34 1/8" (86.6CM) - **X12**

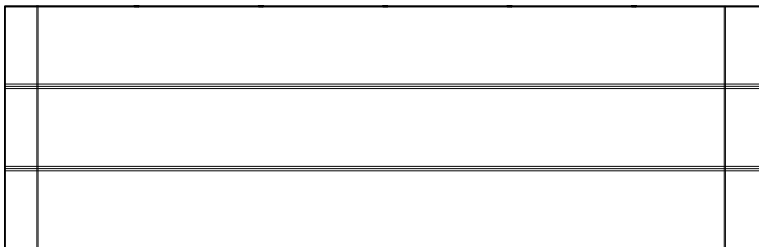

16204 - SLATE - ARDOISE - PIZARRA

15204 - ESPRESSO - EXPRESSO - ESPRESSO

BOARD G - PLANCHE G - TABLERO G

22 1/4IN (56.6CM) - **X10**

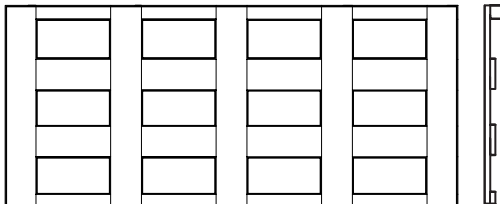

16205 - SLATE - ARDOISE - PIZARRA

15205 - ESPRESSO - EXPRESSO - ESPRESSO

BASKET PANEL H - PANNEAU DE PANIER H - PANEL DE CESTA H

22" X 9 3/4" (55.8 CM X 24.8 CM) - **X2**

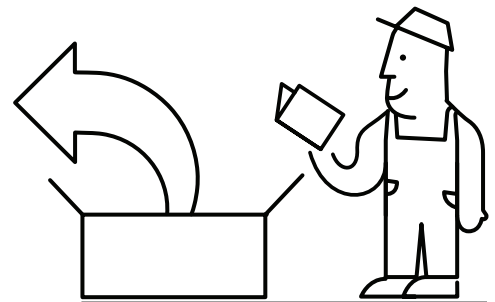

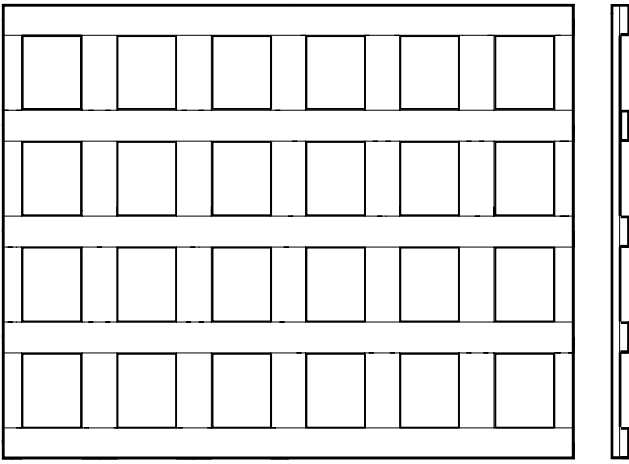

16206 - SLATE - ARDOISE - PIZARRA
15206 - ESPRESSO - EXPRESSO - ESPRESSO
BASKET PANEL I - PANNEAU DE PANIER I - PANEL DE CESTA I
22" X 24 1/2" (55.8 CM X 62.1 CM) - **X1**

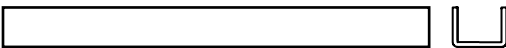

16207 - SLATE - ARDOISE - PIZARRA
15207 - ESPRESSO - EXPRESSO - ESPRESSO
U-SPACER J - U-SPACER J - U-ESPACIADOR J
9 1/2" (24 CM) - **X6**



16208 - SLATE - ARDOISE - PIZARRA
15208 - ESPRESSO - EXPRESSO - ESPRESSO
BRACE K - ENTRETOISE K - ABRAZADERA K
34 1/8" (86.6 CM) - **X3**

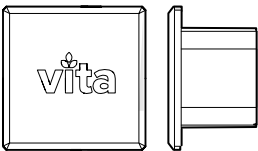

16325
POST CAP L - TETE DE POTEAU L - TAPON L
1 1/4" (3.2 CM) - **X24**

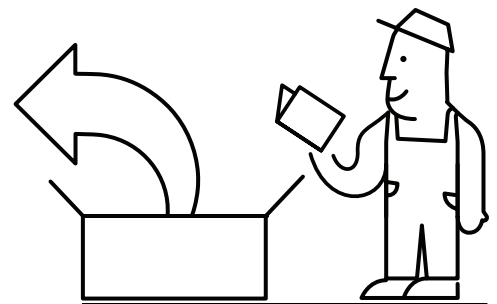

PRODUCT DIMENSIONS

DIMENSIONS DU PRODUIT

DIMENSIONES DEL PRODUCTO

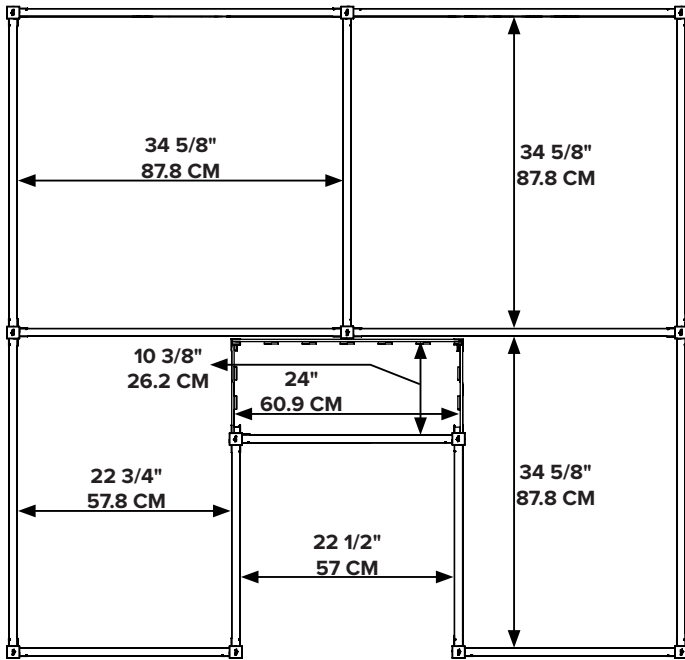

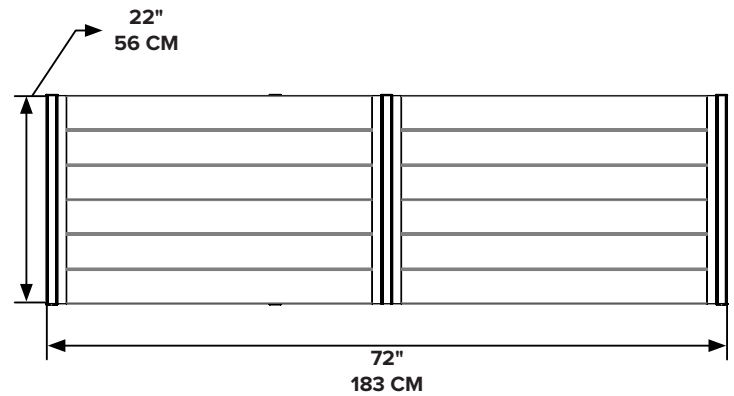
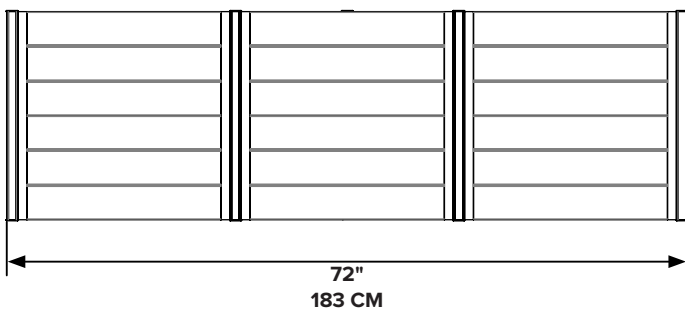

CU M ----- 1.67
CU FT ----- 59.32

56
(30L/1.5CU FT.)

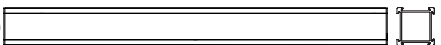

1

16002 - x11 (A) 

16325 - x11 (L) 

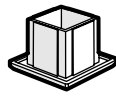
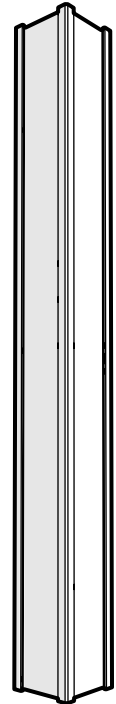

X11

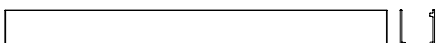

2

16037 - x12 (C) 

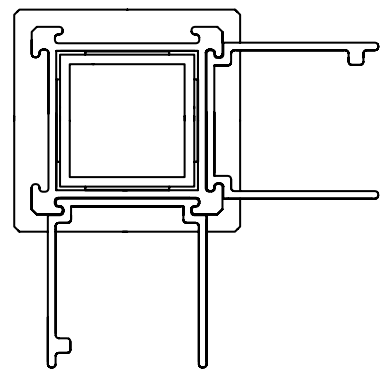
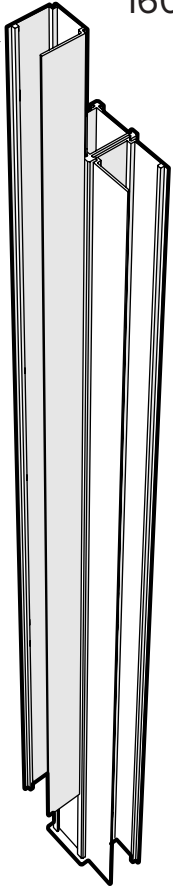
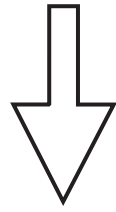
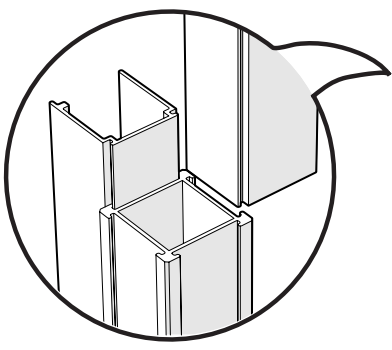

X6



3

16037 - x6 © 

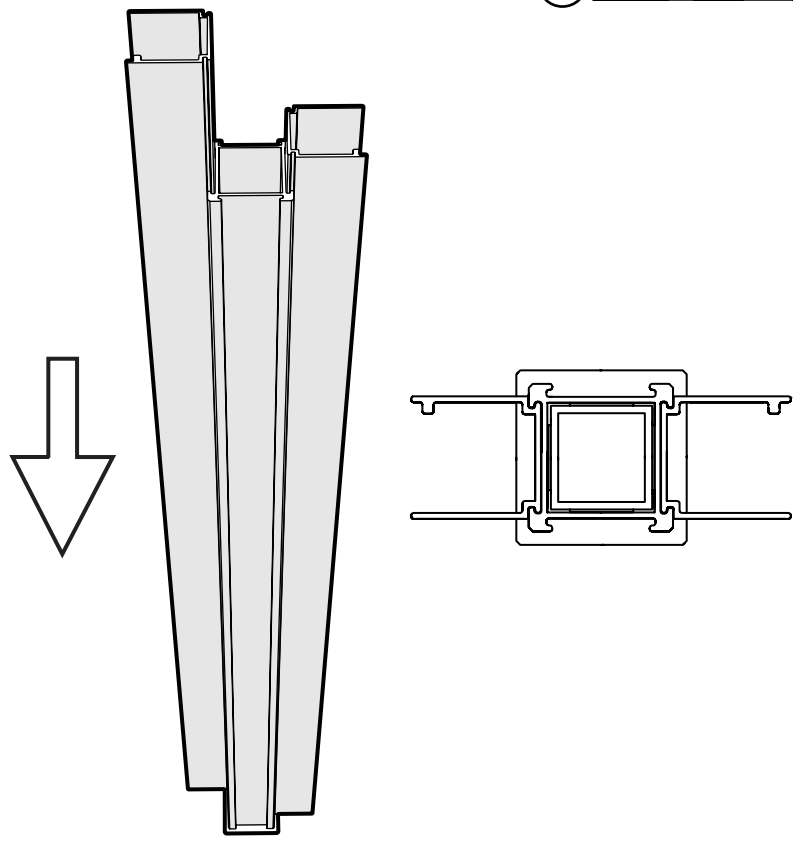

X3



4

16037 - x6 © 

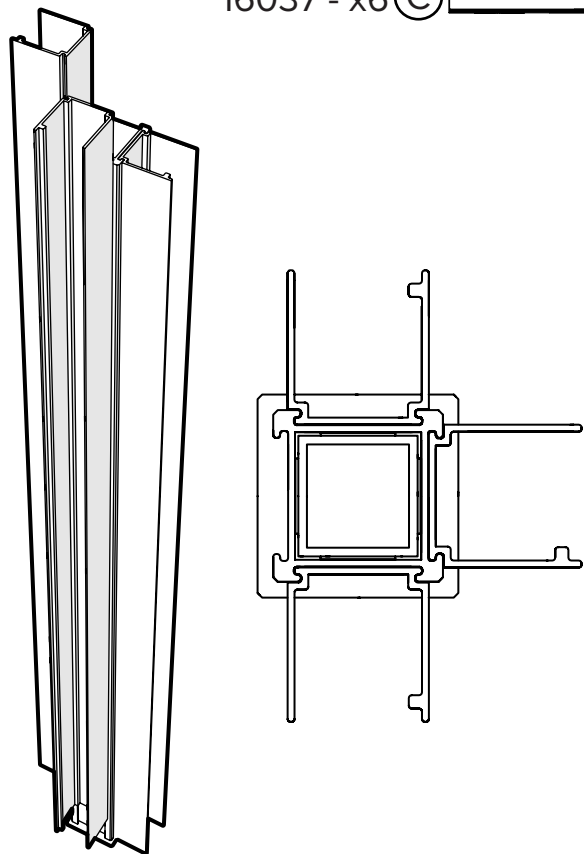

X2



5

16203/15203 - x2 (F)

16204/15204 - x2 (G)

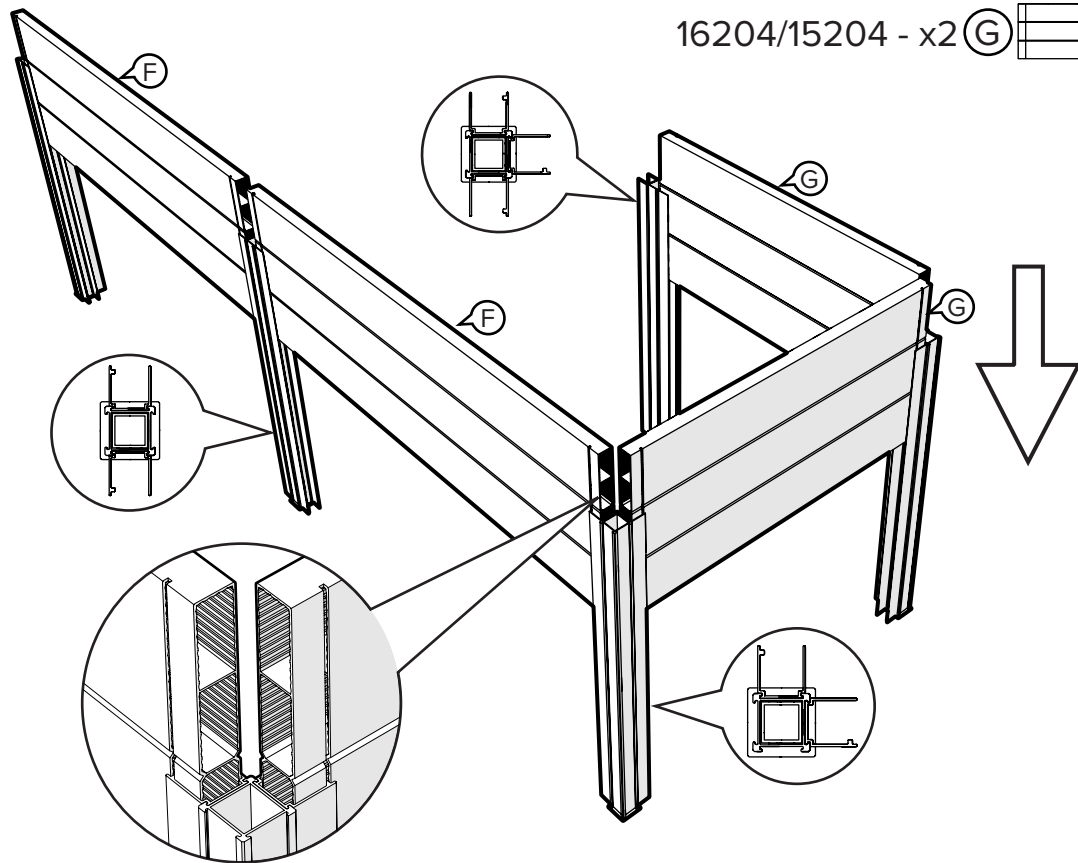

6

16203/15203 - x2 (F)

x1

x1

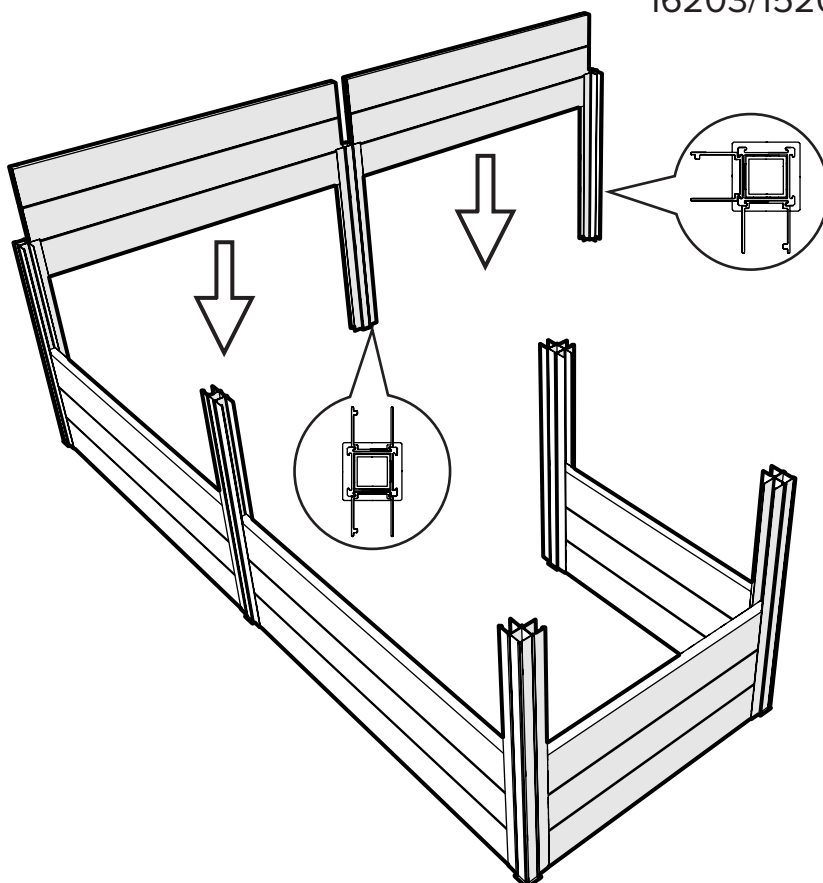

7

16203/15203 - x2 (F)

16204/15204 - x3 (G)

x1

x3

x1

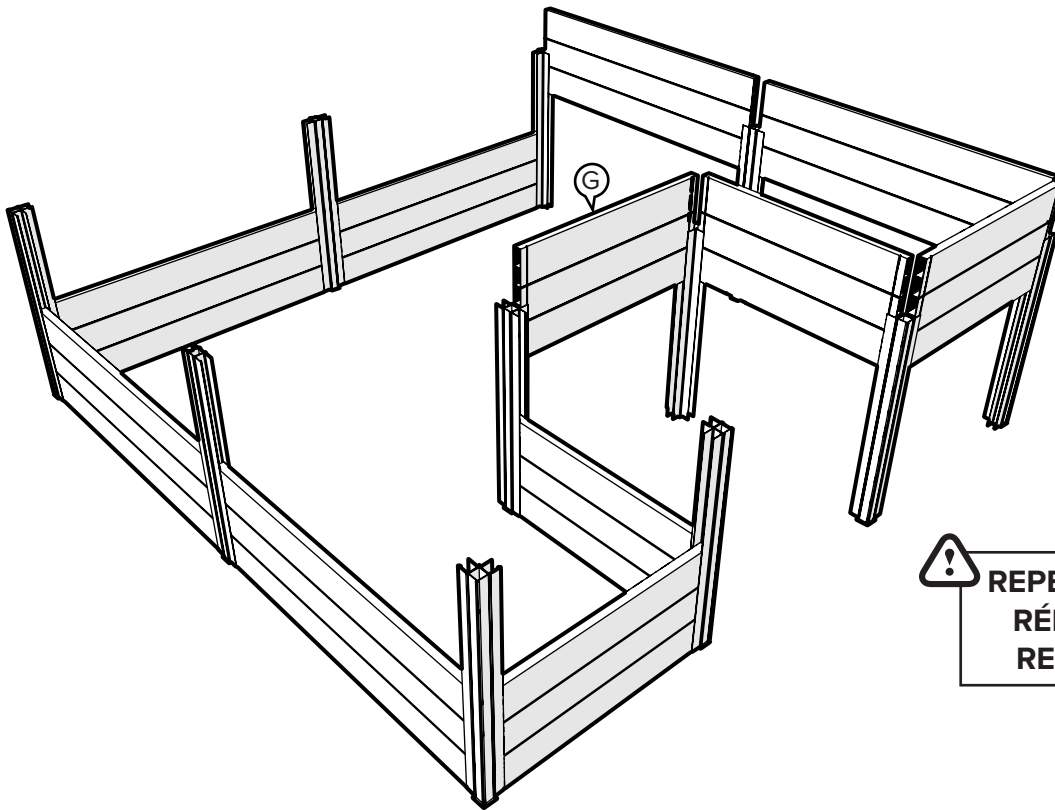

! REPEAT 5 AND 6
 RÉPÉT 5 ET 6
 REPITA 5 Y 6

8

16203/15203 - x6 (F)

16204/15204 - x5 (G)

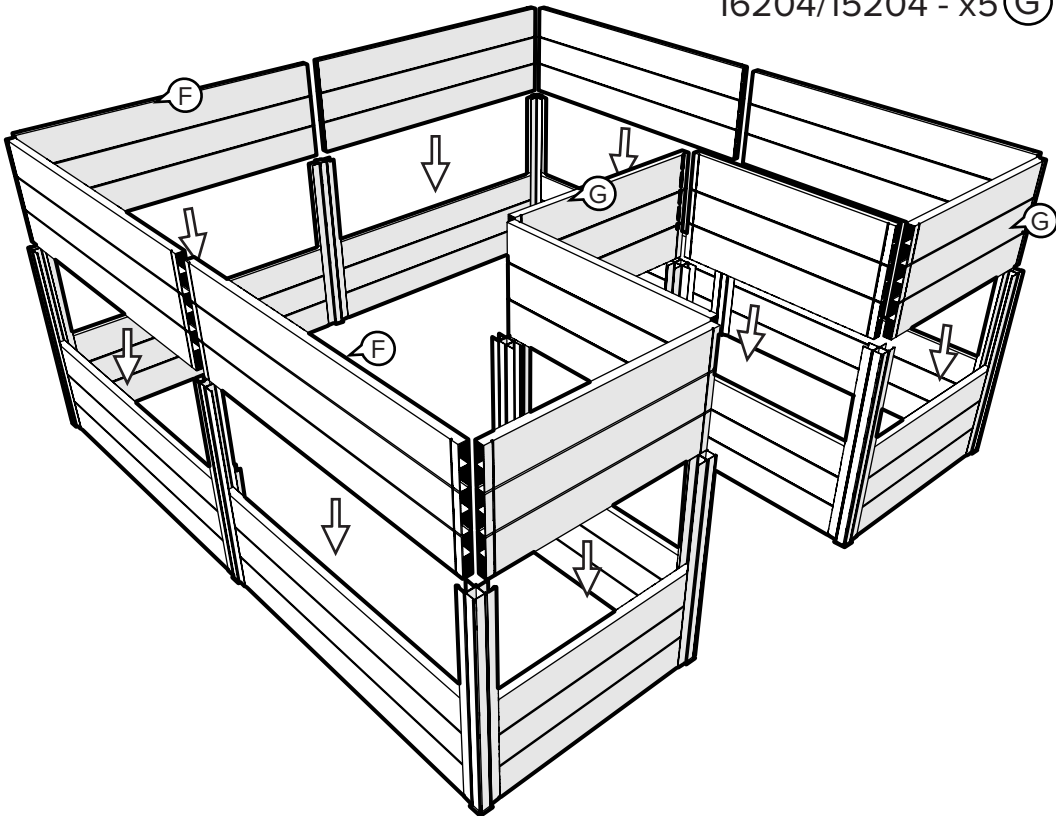

9

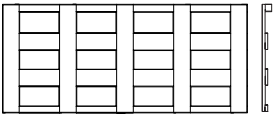
16205/15205 - x2 (H) 

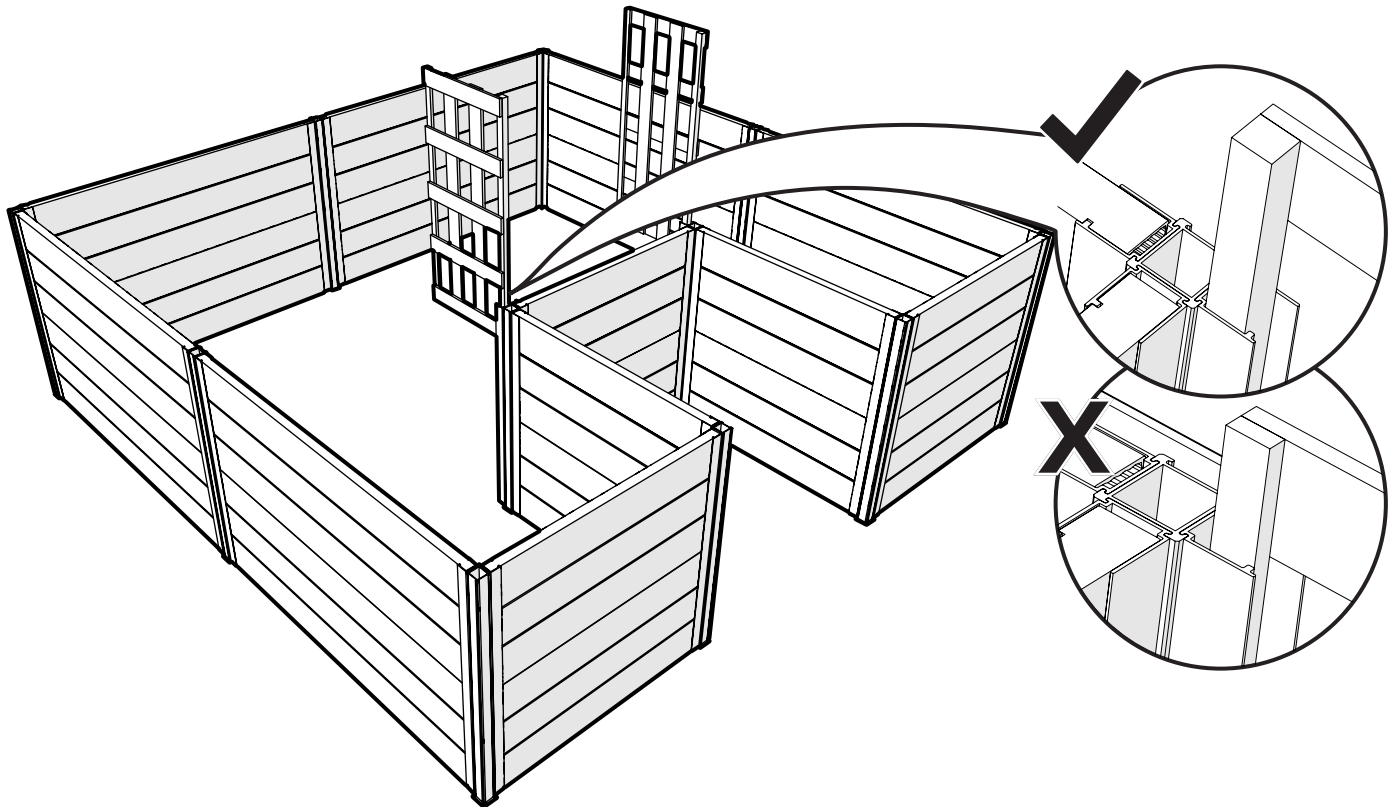

10

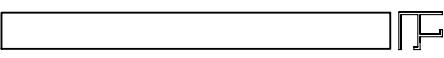
16235 - x2 (F) 

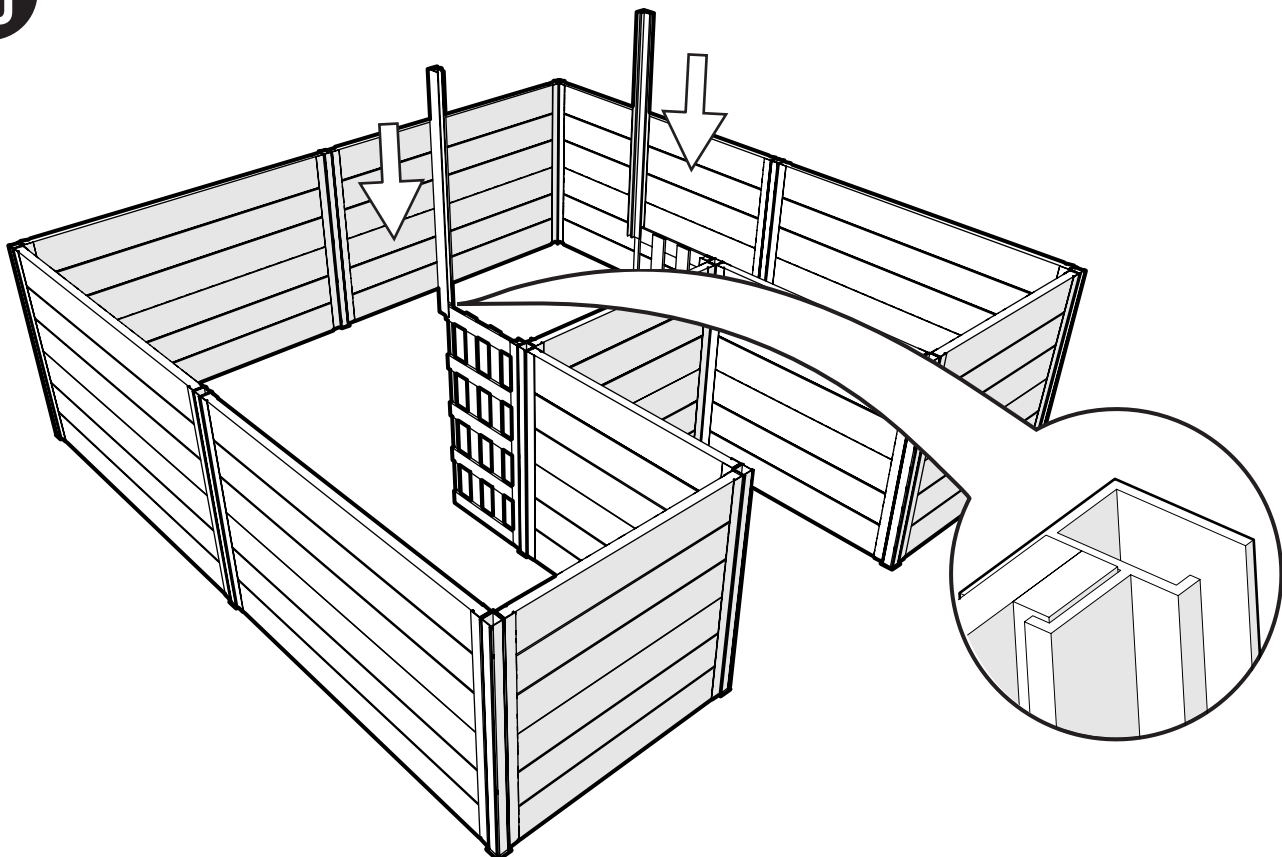

11

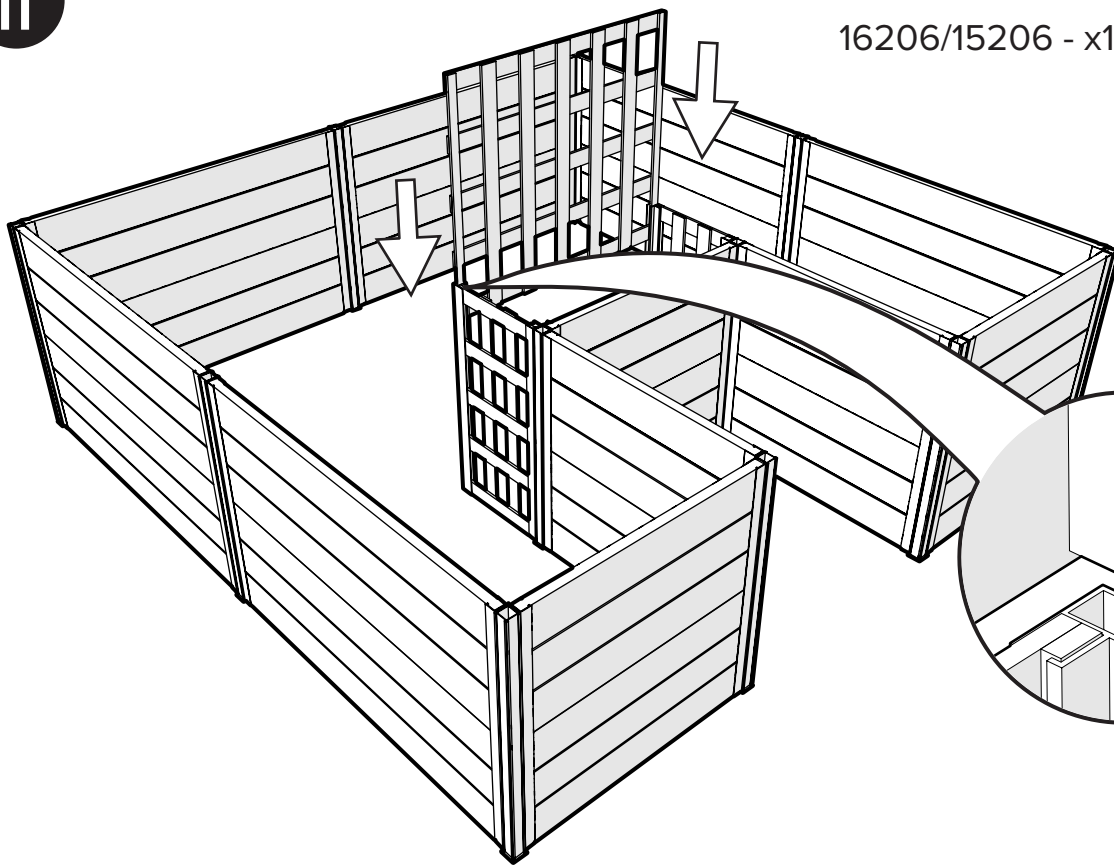

16206/15206 - x1 (I)

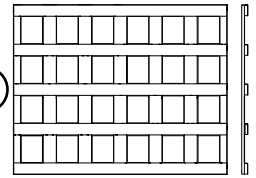

12

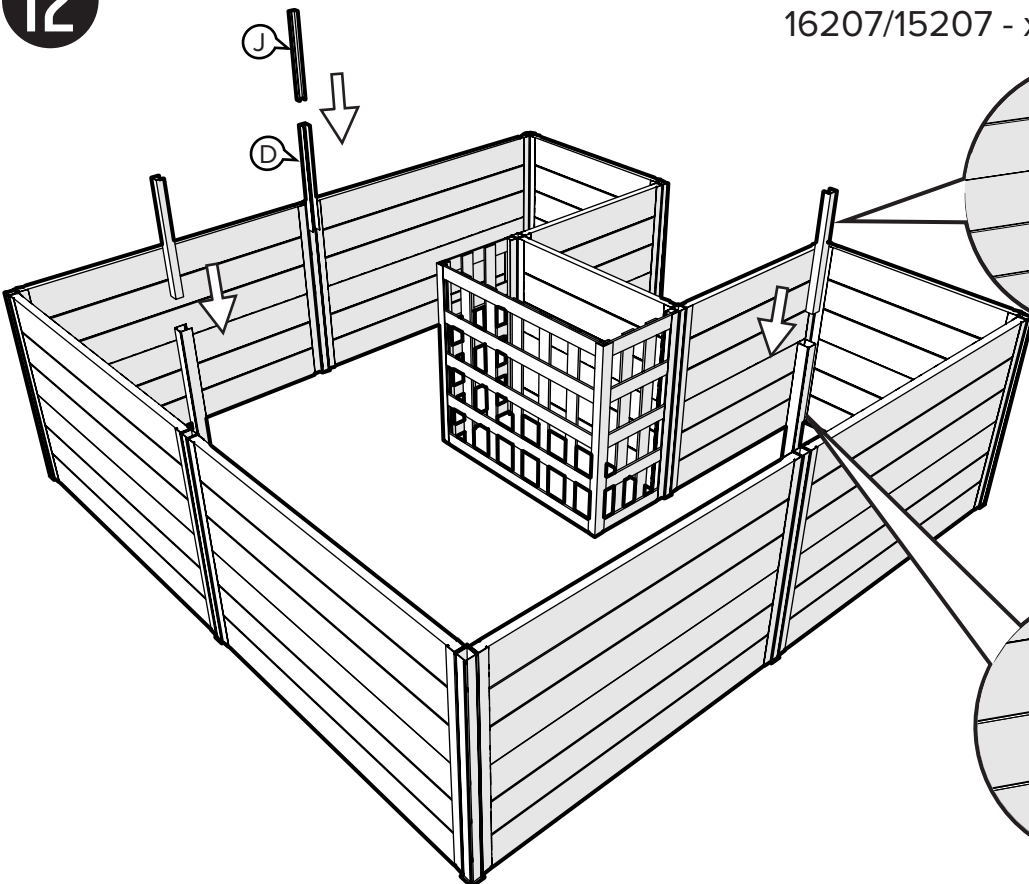

16201- x3 (D)

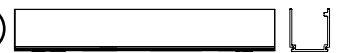

16207/15207 - x3 (J)

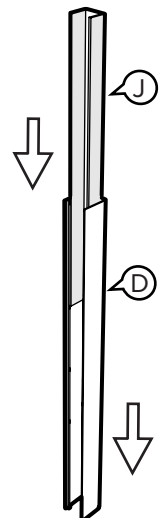
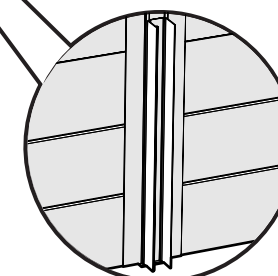
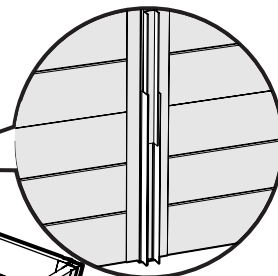
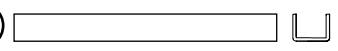

13

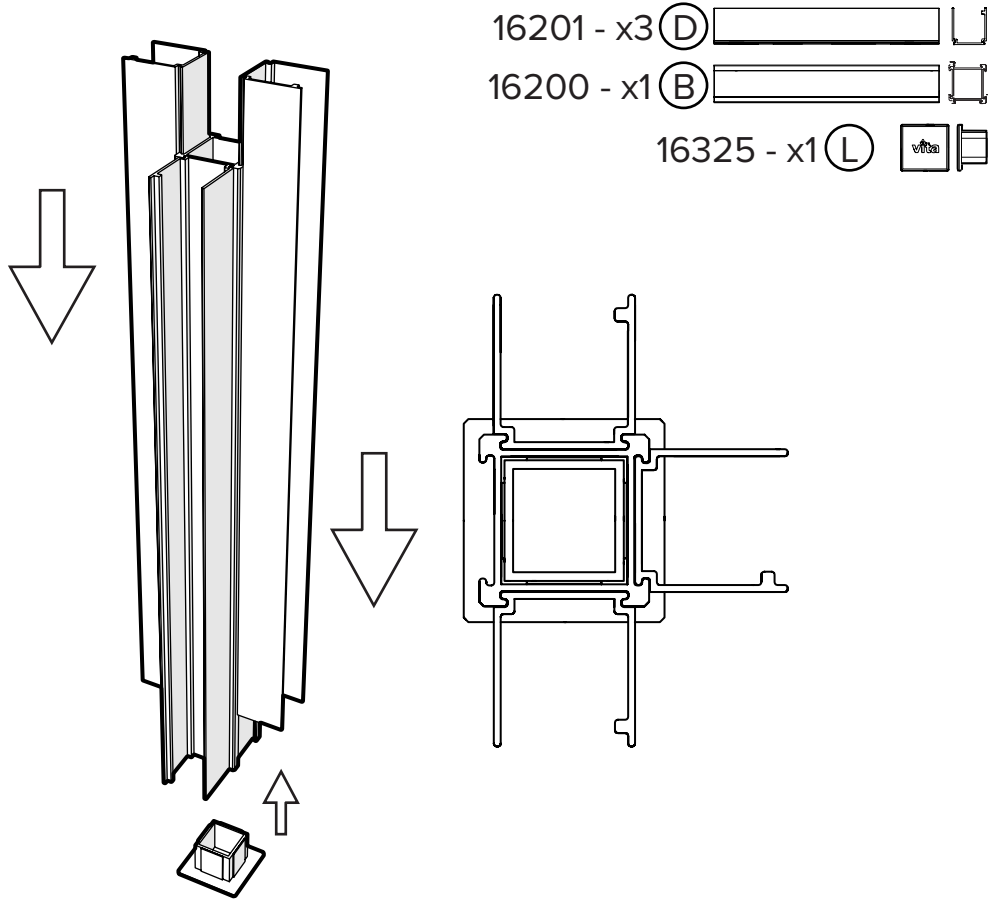

14

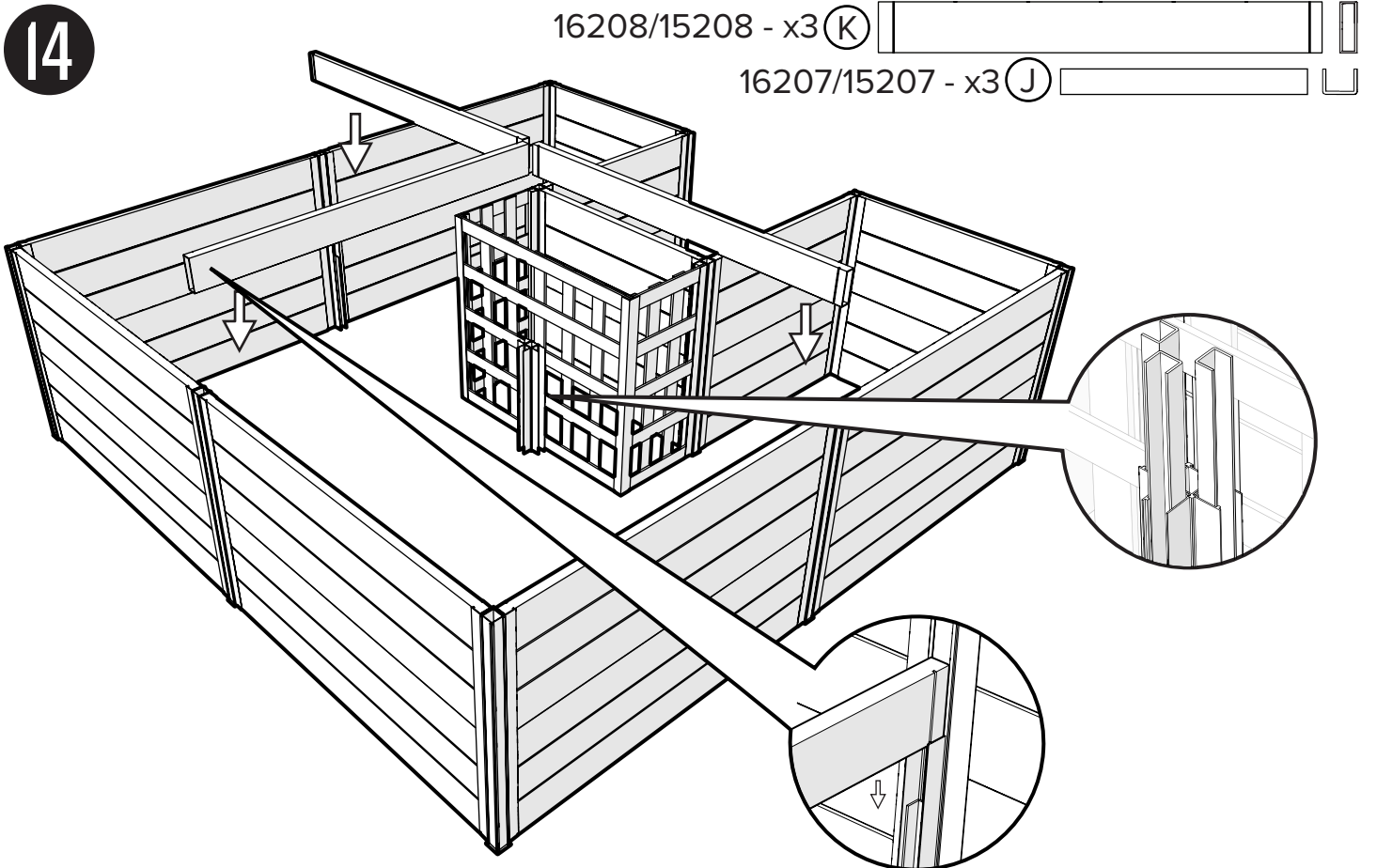

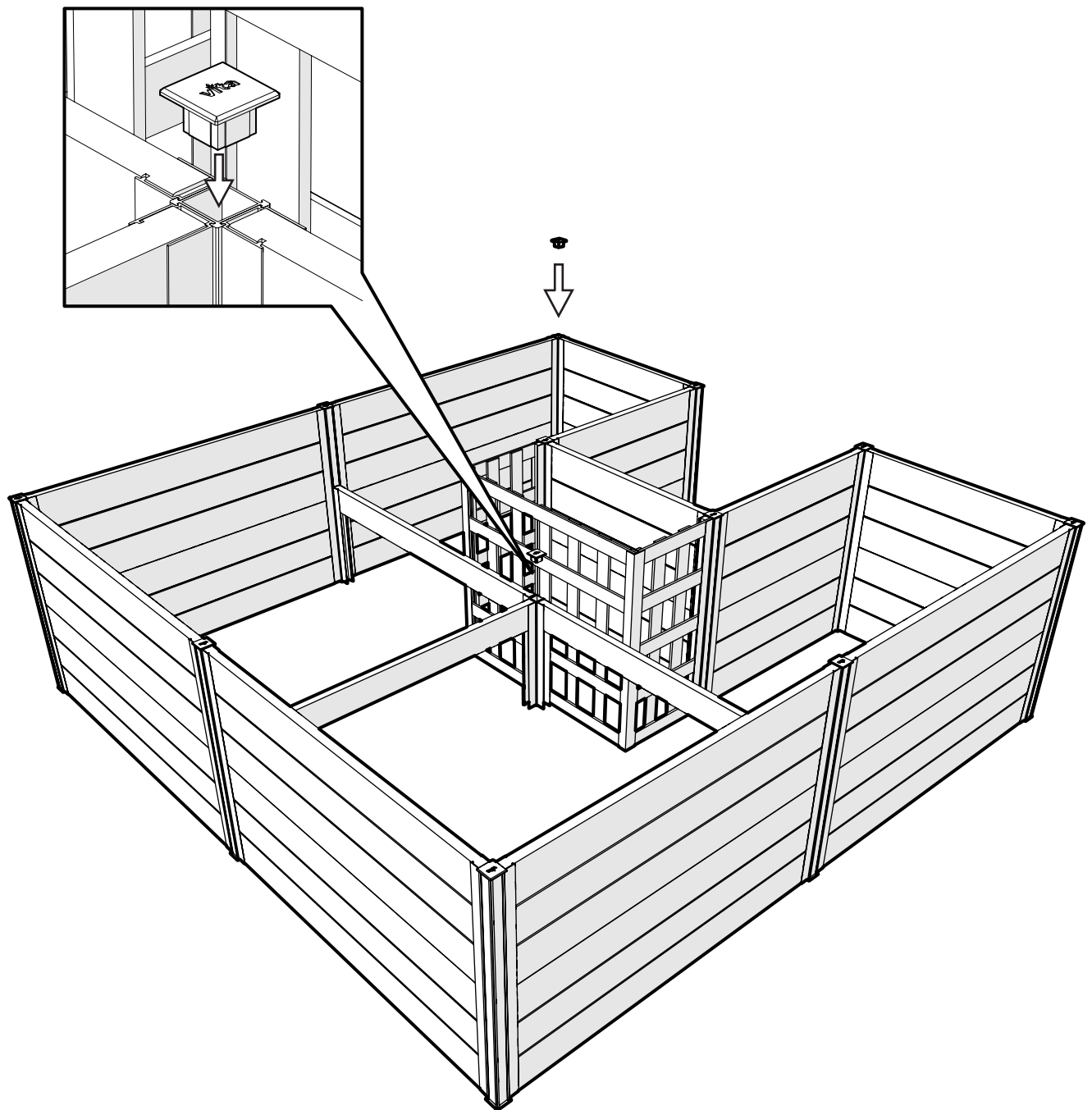

A.

FILL WITH SOIL!
 MIT ERDE FÜLLEN!
 RIEMPI CON TERRA!
 REMPLISSEZ-LE DE TERREAU!
 LLENAR CON LA TIERRA!

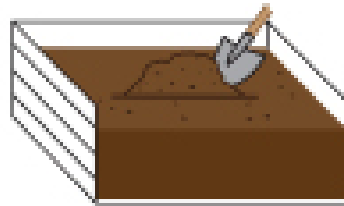

B.

MAKE YOUR OWN SOIL!
 PRODUZIEREN SIE EIGENE ERDE!
 PRODUCI LA TUE TERRA!
 CRÉEZ VOTRE PROPRE TERREAU!
 IGREA TU PROPRIA TIERRA!

1

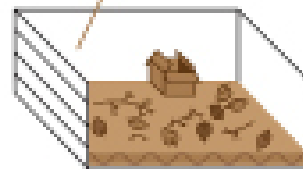

2

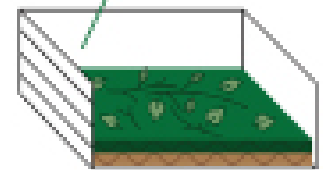

3

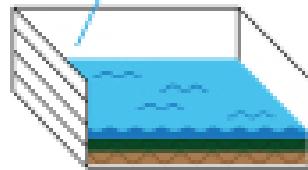

4

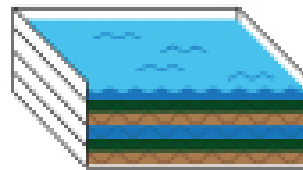

5

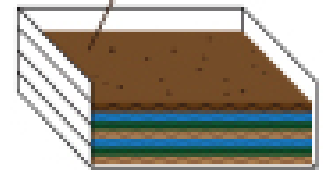

CARBON | CARBONE | CARBÓN
 NITROGEN | AZOTE | NITRÓGENO

