

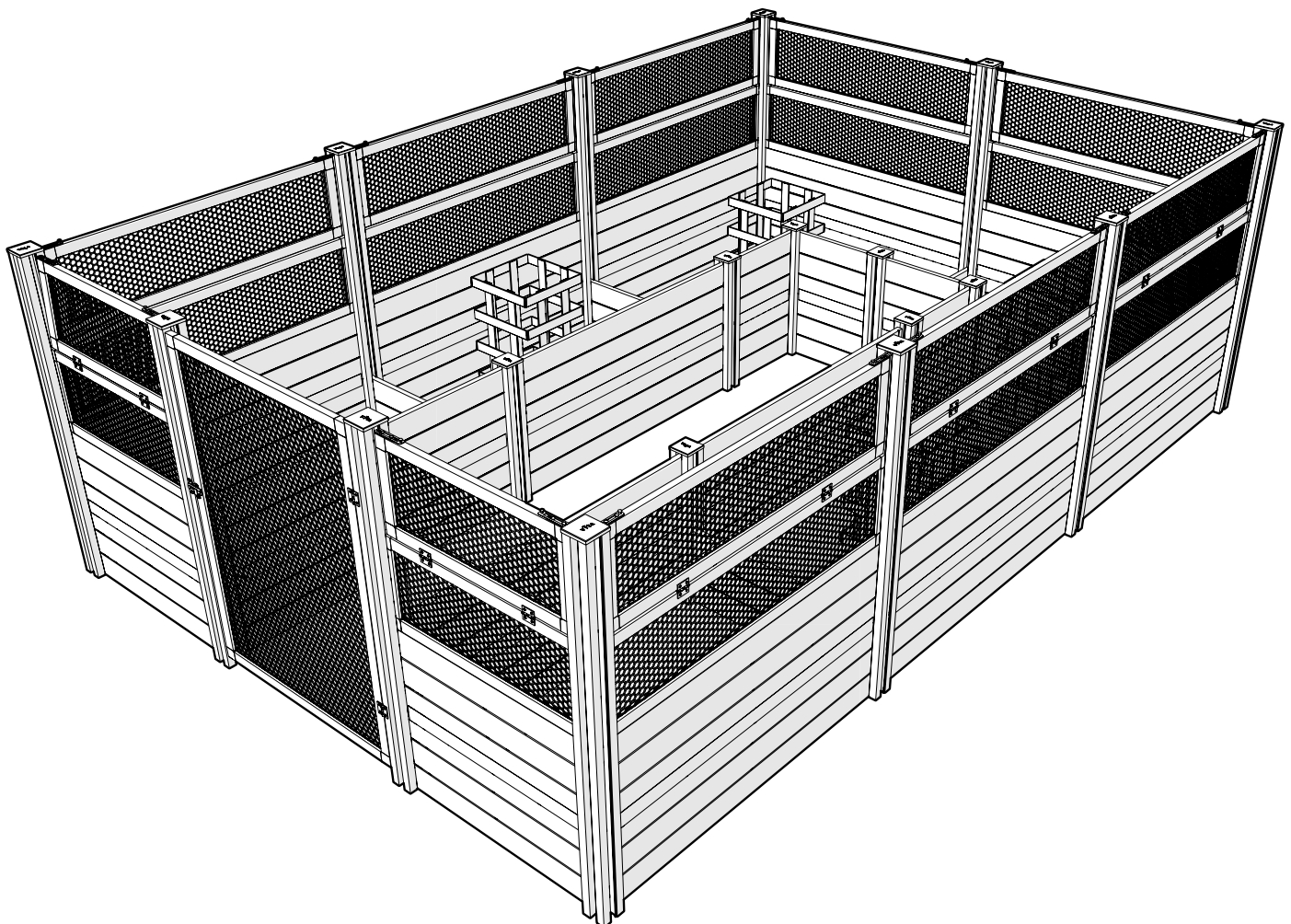

ASSEMBLY GUIDE  
GUIDE DE MONTAGE  
GUÍA DE MONTAJE

CLASSIC  
**8X12 KEYHOLE GARDEN BED**  
JARDIN DE TROU DE SERRURE 8X12  
JARDIN DE LA CERRADURA 8X12

VT17125



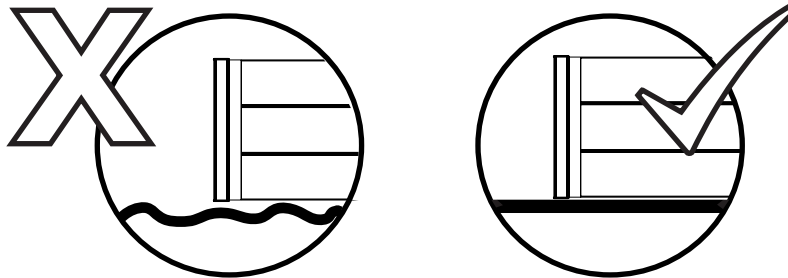
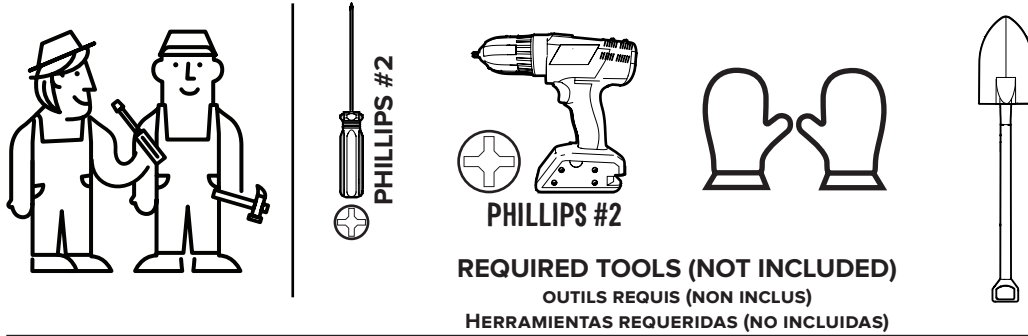
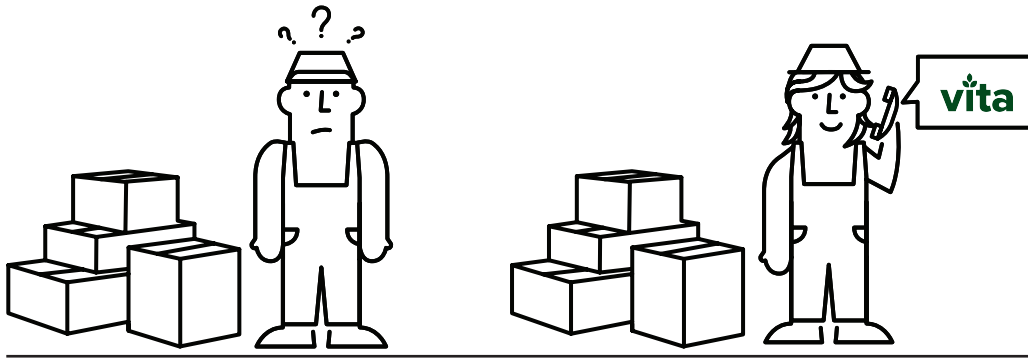

☎ 1-800-282-9346



HELLO@WEAREVITA.COM



WWW.WEAREVITA.COM



8:00 AM - 5:00 PM EST



#### **ASSEMBLY / CARE & USE INSTRUCTIONS**

**IMPORTANT, RETAIN FOR FUTURE REFERENCE: READ CAREFULLY**

**THE ITEM IS INTENDED FOR OUTDOOR DOMESTIC USE ONLY, NOT FOR COMMERCIAL USE.**

**IT IS THE CUSTOMER'S RESPONSIBILITY TO COMPLY WITH ANY BUILDING CODES, ORDINANCES, ZONING LIMITATIONS OR LOCAL HOMEOWNER'S RESTRICTIONS AND OBTAIN ANY REQUIRED PERMIT BEFORE PURCHASE AND INSTALLATION OF THE PRODUCTS.**

**PLEASE WEAR GLOVES AND TAKE NECESSARY PRECAUTIONS TO AVOID INJURY FROM POSSIBLE EXPOSED SHARP EDGES OF INDIVIDUAL ELEMENTS BEFORE ASSEMBLY.**

#### **MONTAGE-, PFLEGE- & BEDIENUNGSANLEITUNG**

**WICHTIG, ZUR SPÄTEREN EINSICHTNAHME AUFBEWAHREN: SORGFÄLTIG DURCHLESEN**

**DIESER ARTIKEL IST NUR ZUR PRIVATEN VERWENDUNG IM FREIEN UND NICHT ZUR GEWERBLICHEN NUTZUNG BESTIMMT.**

**ES LIEGT IN DER VERANTWORTUNG DES KUNDEN, ALLE BAUVORSCHRIFTEN, VERORDNUNGEN, BAUBESCHRÄNKUNGEN UND REGIONALE BESCHRÄNKUNGEN FÜR HAUSBESITZER EINZUHALTEN UND VOR DEM KAUF UND DER MONTAGE DER PRODUKTE ALLE NOTWENDIGEN GENEHMIGUNGEN EINZUHOLEN.**

**BITTE TRAGEN SIE HANDSCHUHE UND TREFFEN SIE ALLE NÖTIGEN VORKEHRUNGEN, UM VOR UND WÄHREND DER MONTAGE VERLETZUNGEN DURCH SCHARFE KANTEN VON EINZELTEILEN ZU VERMEIDEN.**

#### **ISTRUZIONI DI MONTAGGIO, UTILIZZO E MANUTENZIONE**

**IMPORTANTE, CONSERVALO PER CONSULTARLO ANCHE IN FUTURO: LEGGERE ATTENTAMENTE**

**QUEST'ARTICOLO È INTESO UNICAMENTE PER L'USO DOMESTICO ALL'APERTO, NON PER USO COMMERCIALE.**

**È RESPONSABILITÀ DEL CLIENTE OSSERVARE TUTTE LE NORME EDILIZIE, ORDINANZE, LIMITI DI ZONIZZAZIONE O RESTRIZIONI LOCALI DEL PROPRIETARIO ED OTTENERE TUTTI I PERMESSI NECESSARI PRIMA DELL'ACQUISTO E DELL'INSTALLAZIONE DEL PRODOTTO.**

**TI PREGHIAMO D'INDOSSARE I GUANTI ED ADOTTARE LE MISURE NECESSARIE PER EVITARE LESIONI PROVOCATE DA EVENTUALI BORDI TAGLIANTI DI SINGOLI ELEMENTI PRESENTI PRIMA DEL MONTAGGIO.**

#### **INSTRUCCIONES DE MONTAJE / CUIDADO Y USO**

**IMPORTANTE; CONSERVALAS PARA FUTURAS CONSULTAS: LEE ATENTAMENTE**

**EL ARTÍCULO ES PARA USO DOMÉSTICO AL AIRE LIBRE SOLAMENTE, NO PARA USO COMERCIAL.**

**ES RESPONSABILIDAD DEL CLIENTE CUMPLIR CON LOS CÓDIGOS DE EDIFICACIÓN, ORDENANZAS, LIMITACIONES DE ZONIFICACIÓN O RESTRICCIONES LOCALES DEL PROPIETARIO Y OBTENER CUALQUIER PERMISO NECESARIO ANTES DE COMPRAR E INSTALAR LOS PRODUCTOS.**

**POR FAVOR USAR GUAANTES Y TOMAR LAS PRECAUCIONES NECESARIAS PARA EVITAR CUALQUIER LESIÓN DEBIDO A BORDES AFILADOS DE LOS ELEMENTOS ANTES DE SU MONTAJE.**

#### **INSTRUCTIONS POUR LE MONTAGE / ENTRETIEN / UTILISATION**

**IMPORTANT, CONSERVEZ CECI POUR LE CONSULTER PLUS TARD: LISEZ ATTENTIVEMENT**

**CET ARTICLE EST DESTINÉ UNIQUEMENT À UN USAGE DOMESTIQUE À L'EXTERIEUR, PAS À UN USAGE COMMERCIAL.**

**IL EN VA DE LA RESPONSABILITE DU CLIENT DE SE CONFORMER A TOUT REGLEMENT DE CONSTRUCTION, TOUTE ORDONNANCE, TOUTE LIMITATION DE ZONAGE OU TOUTE RESTRICTION DE PROPRIETE LOCALE ET D'OBTENIR TOUT PERMIS OBLIGATOIRE AVANT L'ACQUISITION OU L'INSTALLATION DE NOS PRODUITS**

**VEUILLEZ PORTER DES GANTS ET PRENDRE LES PRECAUTIONS NECESSAIRES POUR EVITER TOUTE BLESSURE QUI POURRAIT ETRE CAUSEE PAR LES BORDS COUPANTS EXPOSES DES ELEMENTS AVANT LE MONTAGE.**

# PARTS LIST

# LISTE DES PIÈCES

# LISTA DE PARTES

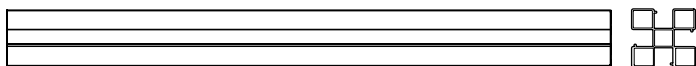

**11166 - POST A** - PUBLIER A - EXPONER A  
46 5/8" (118.4 CM) - **X9**

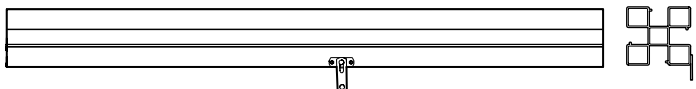

**11167 - POST B** - PUBLIER B - EXPONER B  
46 5/8" (118.4 CM) - **X1**

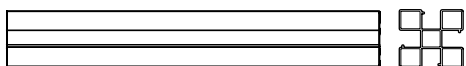

**11169 - POST C** - PUBLIER C - EXPONER C  
22 3/4" (57.78 CM) - **X7**

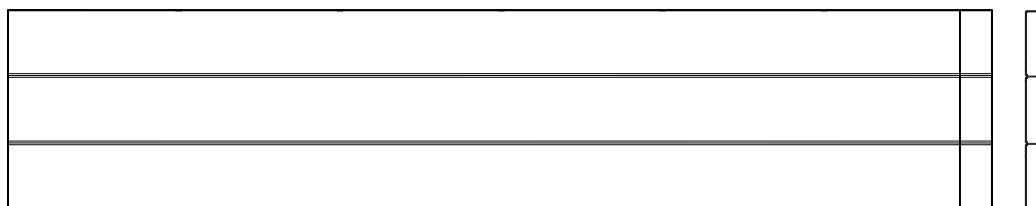

**11170**  
**BOARD A** - PLANCHE A - TABLERO A  
46" (116.8 CM) - **X24**

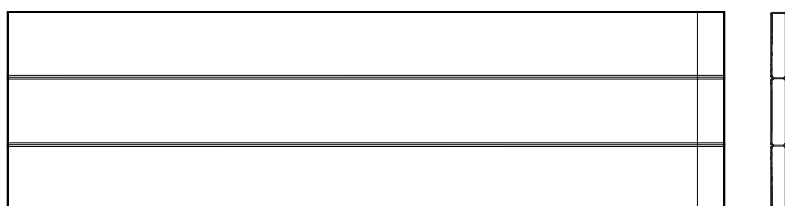

**11171**  
**BOARD B** - PLANCHE B - TABLERO B  
28 7/8" (73.4 CM) - **X9**

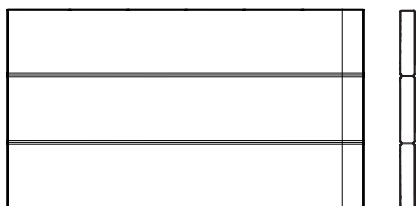
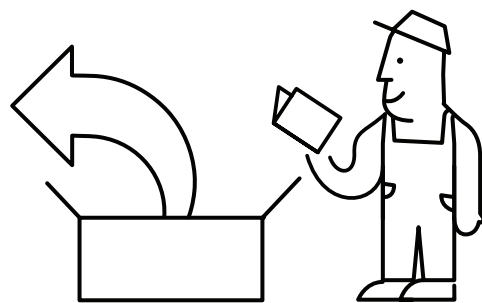

**11172**  
**BOARD C** - PLANCHE C - TABLERO C  
16" (41 CM) - **X8**

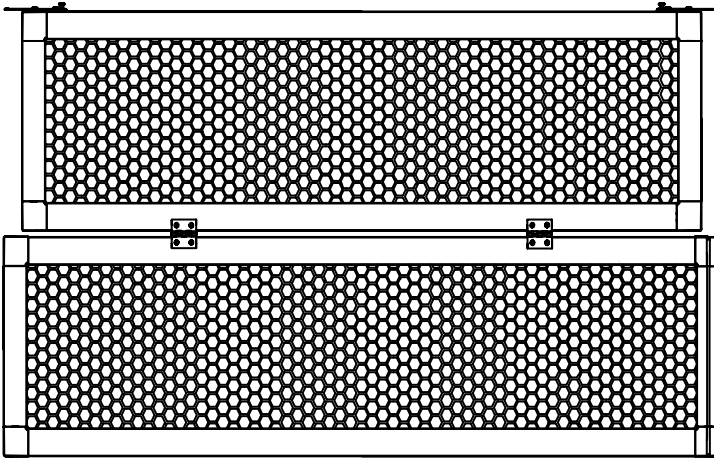

**11174**  
**FENCE PANEL B - PANNEAU DE CLÔTURE B - PANEL DE VALLA B**  
28 3/4" (73 CM) - X2

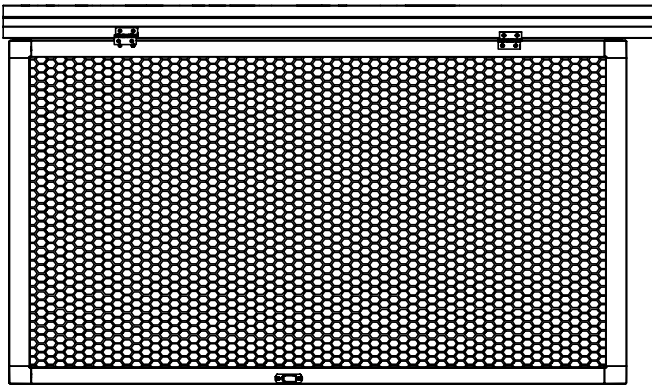

**11175**  
**DOOR - PORTE - PUERTA**  
34 1/8" x 46 1/2" (86.7CM x 118.1cm) - X1

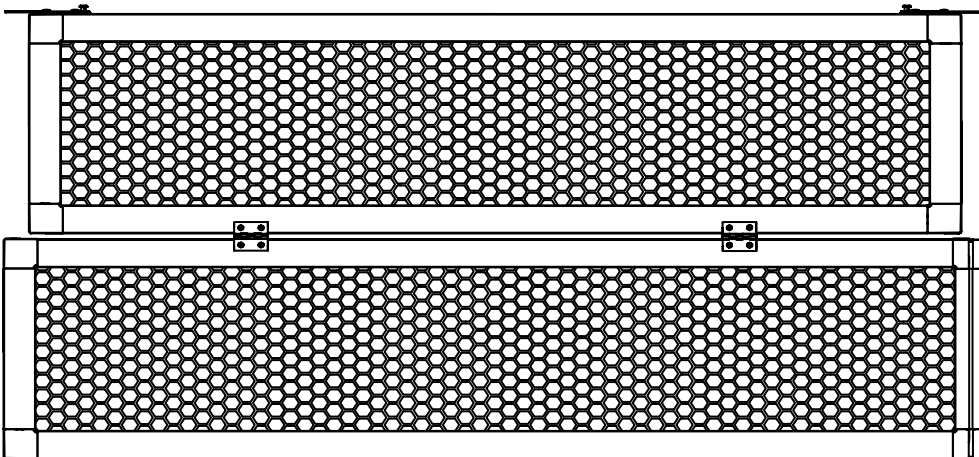

**11173**  
**FENCE PANEL A - PANNEAU DE CLÔTURE A - PANEL DE VALLA A**  
46" (116.7 CM) - X8

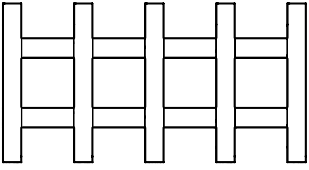

**60008**

**BASKET PANEL** - PANNEAU DE PANIER - CESTA PANEL

23" (58.4CM) - **X16**

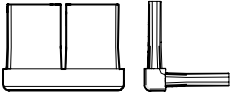

**60009**

**BASKET BRACKET** - SUPPORT DE PANIER - SOPORTE DE CANASTA

1" x 1" (2.5 CM x 2.5 CM) - **X80**



**10766**

**POST CAP** - ETE DE POTEAU - TAPON

3" x 3" (7.6 CM x 7.6 CM) - **X18**

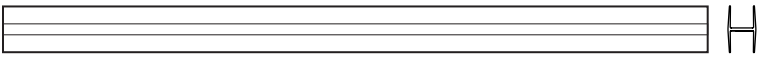

**11184**

**H-CHANNEL** - H-CHAÎNE - H - CANAL (A)

26 3/8" (67 CM) - **X2**

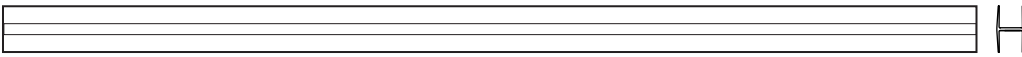

**11185**

**H-CHANNEL** - H-CHAÎNE - H - CANAL (B)

43 3/4" (111.1 CM) - **X12**

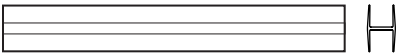

**11186**

**H-CHANNEL** - H-CHAÎNE - H - CANAL (C)

13 3/4" (34.9 CM) - **X4**

# PRODUCT DIMENSIONS

DIMENSIONS DU PRODUIT

DIMENSIONES DEL PRODUCTO

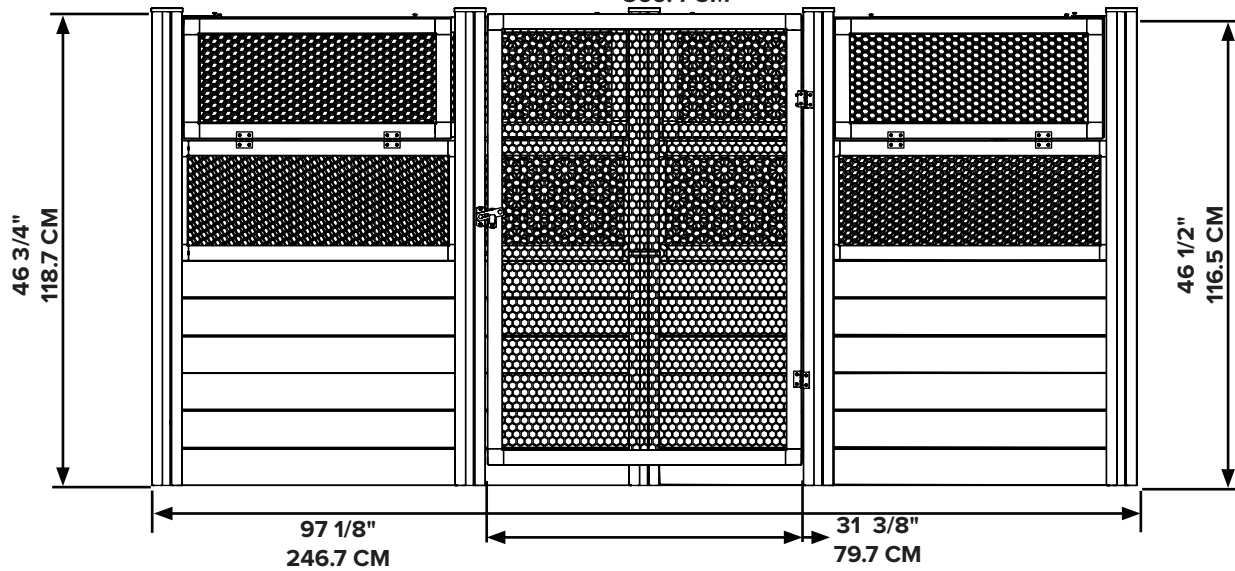
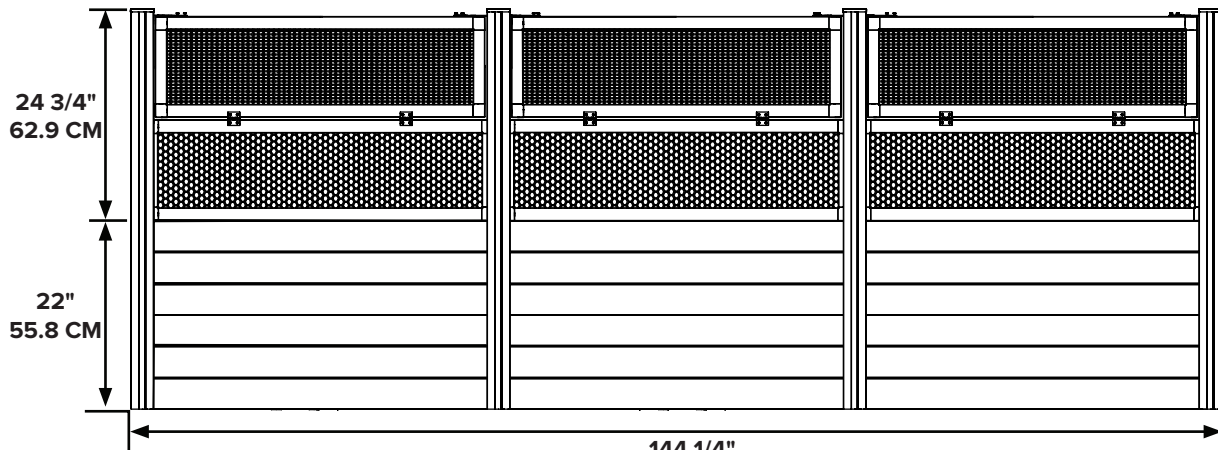
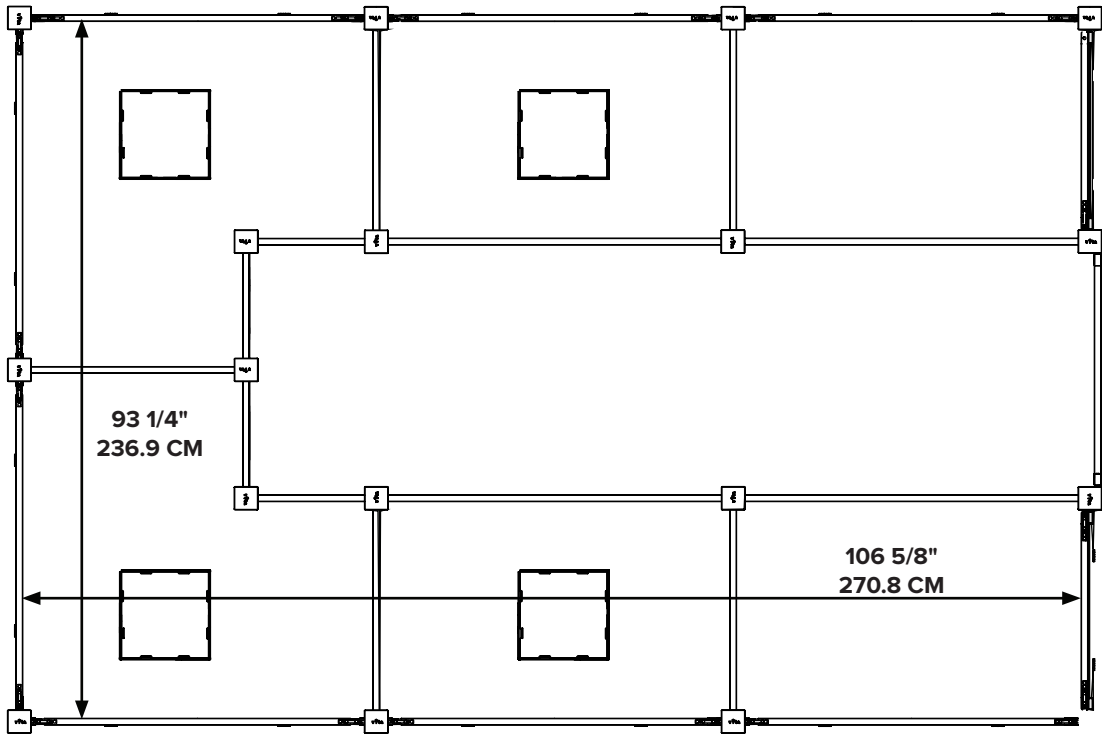

**FOR THE GATE AND MESH PANELS TO OPERATE CORRECTLY, IT IS CRITICAL THAT YOUR GARDEN IS INSTALLED OVER A VERY LEVEL SURFACE. SOME SUGGESTED IDEAS FOR PREPARING THE SURFACE ARE AS FOLLOWS:**

POUR QUE LA PORTE ET LE PANNEAU GRILLAGÉ FONCTIONNENT CORRECTEMENT, IL EST IMPORTANT QUE VOTRE JARDIN SOIT INSTALLÉ SUR UNE SURFACE PARFAITEMENT PLANE. VOICI QUELQUES SUGGESTIONS POUR PRÉPARER LA SURFACE.

PARA QUE LA PUERTA Y LOS PANELES DE MALLA FUNCIONEN CORRECTAMENTE, ES FUNDAMENTAL QUE INSTALE SU JARDÍN SOBRE UN SUELO BIEN NIVELADO. AQUÍ LE SUGERIMOS ALGUNAS IDEAS PARA PREPARAR LA SUPERFICIE.

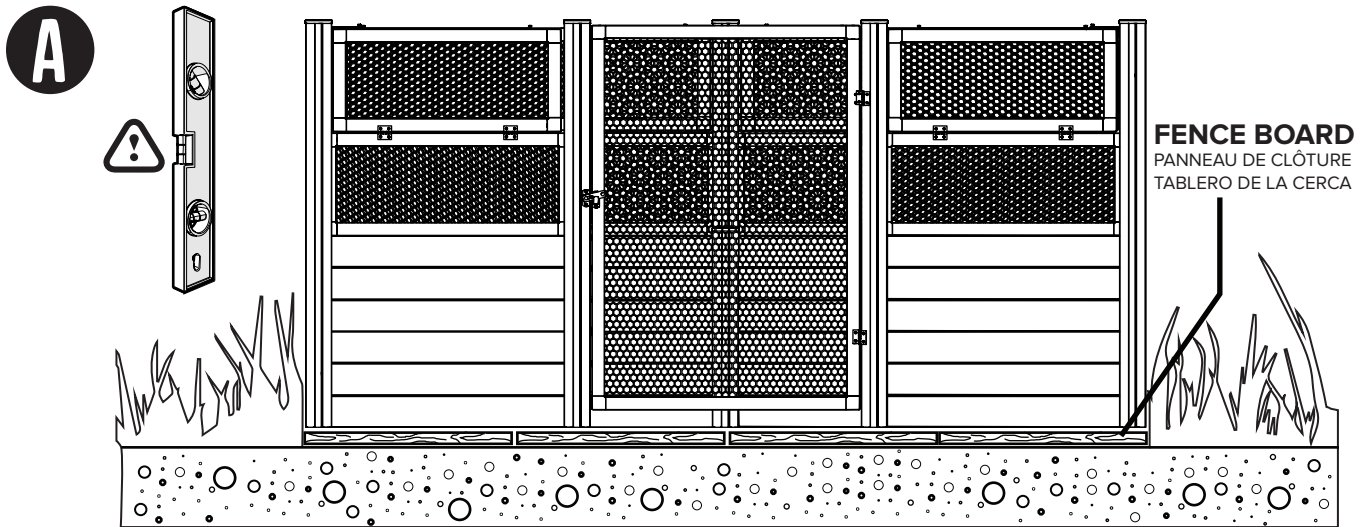

**CONSIDER PURCHASING SOME FENCE BOARDS TO LAY ON THE GROUND, AND DIRECTLY UNDER THE EDGES OF THE GARDEN.**

ENVISAGEZ D'ACHETER QUELQUES PLANCHES DE PALISSADE À POSER SUR LE SOL, ET DIRECTEMENT SOUS LES BORDS DU JARDIN.

CONSIDERE LA POSIBILIDAD DE COMPRAR ALGUNAS TABLAS PARA COLOCAR SOBRE EL SUELO Y DEBAJO DE LOS BORDES DEL JARDÍN.

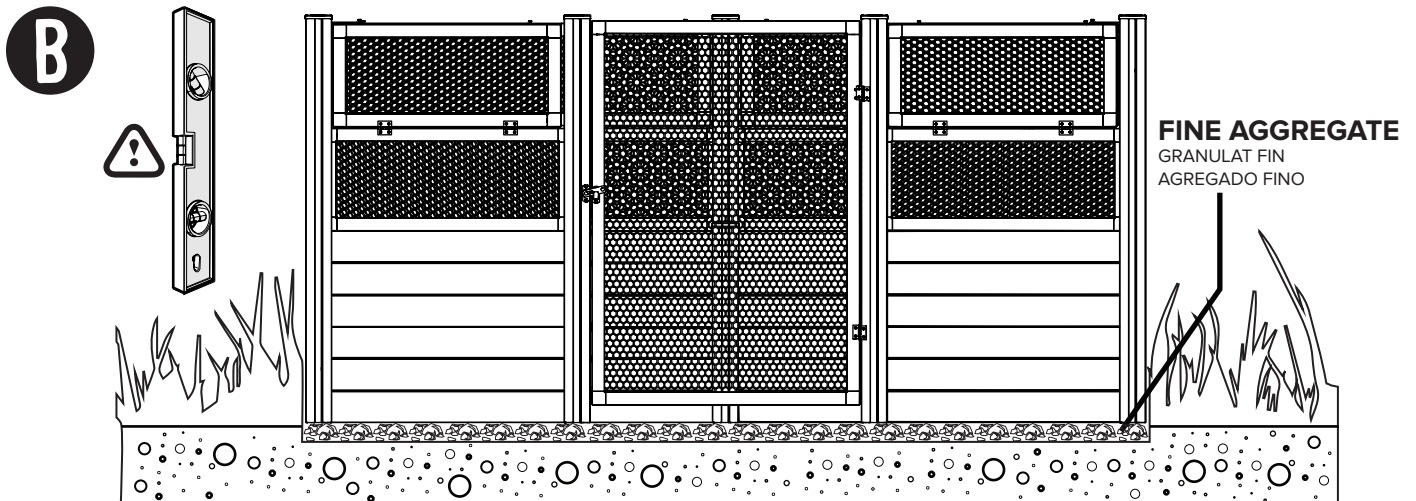

**CUT OUT THE GROUND AND INSTALL SOME FINE AGGREGATE OR SCREENINGS USED FOR UNDER PATIO STONES TO CREATE A LEVEL SURFACE FOR YOUR GARDEN.**

CREUSEZ LÉGÈREMENT LE SOL ET INSTALLEZ DES GRAVIERS OU DU GRAVILLON QU'ON PLACE SOUS LES PIERRES D'UN PATIO POUR CRÉER UNE SURFACE PARFAITEMENT PLANE ET NIVELÉE POUR VOTRE JARDIN.

RETIRE EL SUELO Y COLOQUE AGÚN AGREGADO FINO O GRAVA DE LA QUE SUELE UTILIZARSE DEBAJO DE LAS PIEDRAS DEL PATIO PARA CREAR UNA SUPERFICIE NIVELADA EN SU JARDÍN.



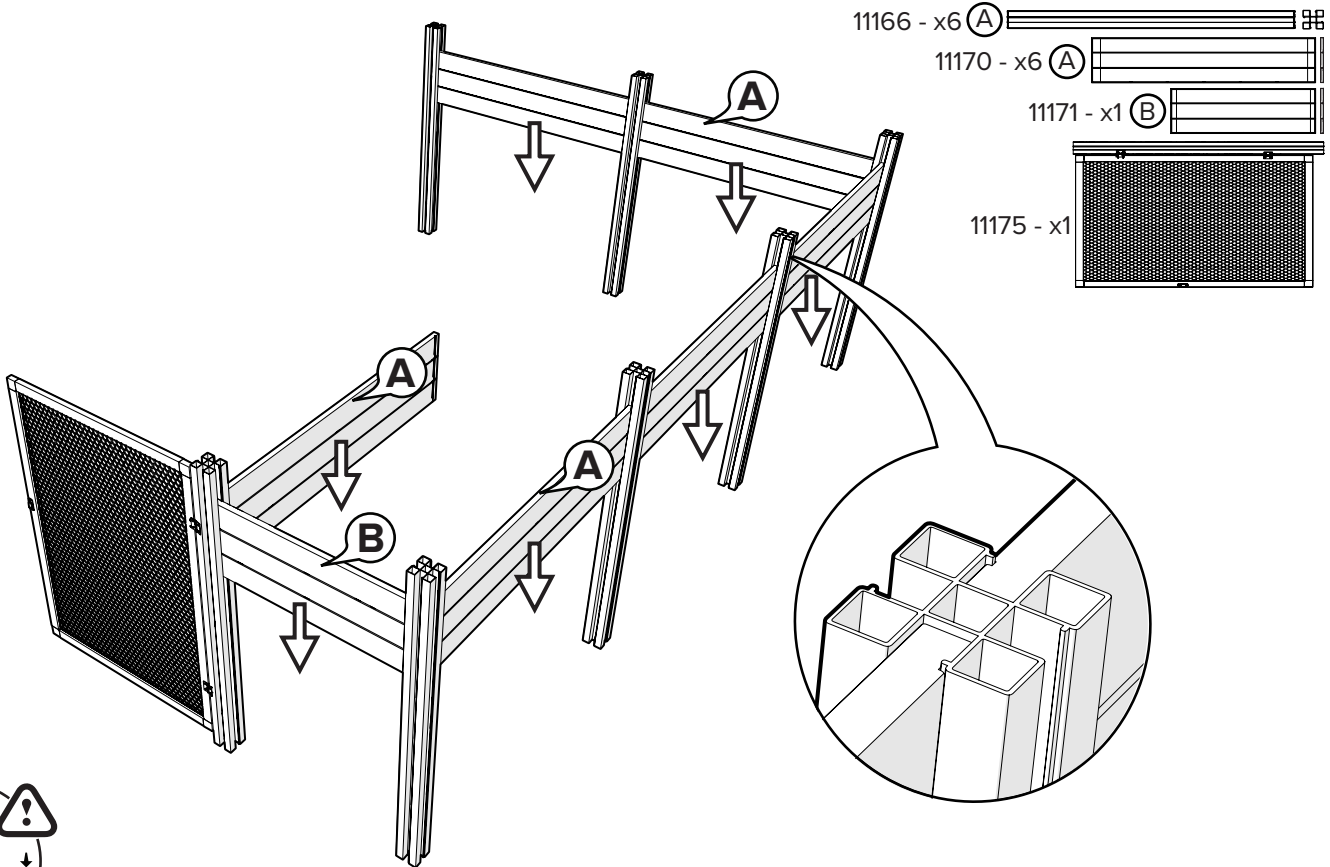

1

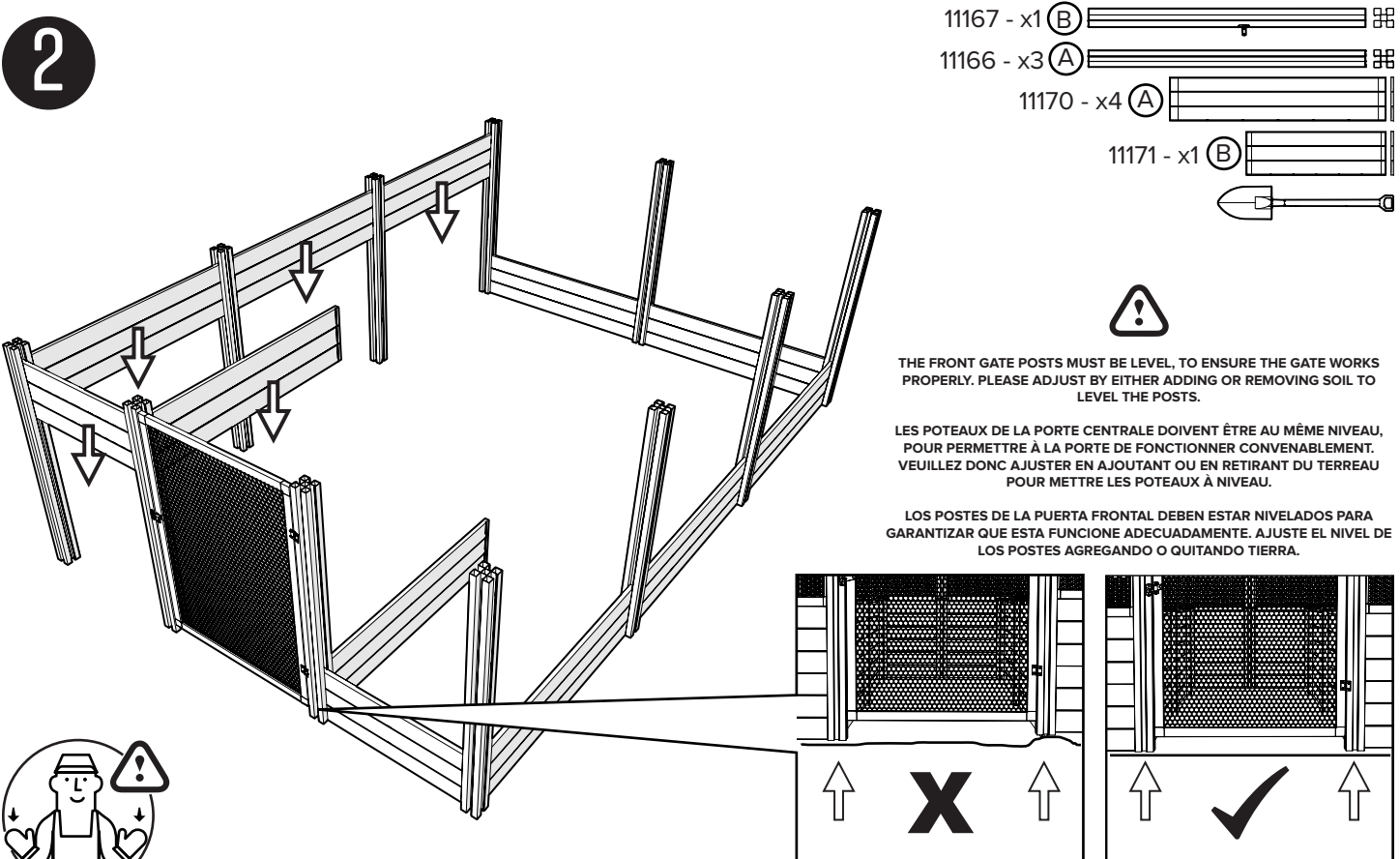

2

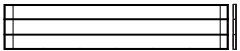

3

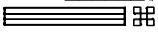
- 11170 - x2 (A) 
- 11172 - x4 (C) 
- 11169 - x7 (C) 

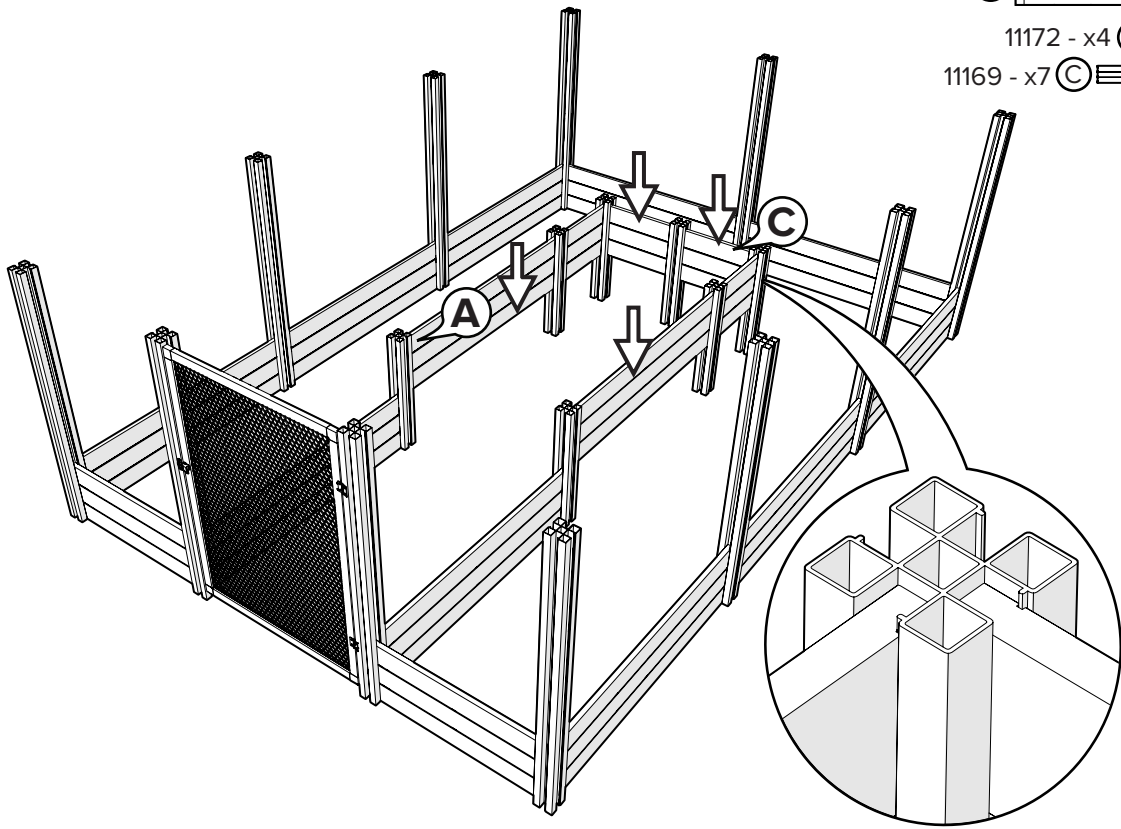

4

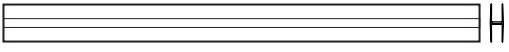
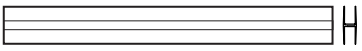
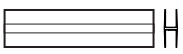
- 11185 - x12 (B) 
- 11184 - x2 (A) 
- 11186 - x4 (C) 

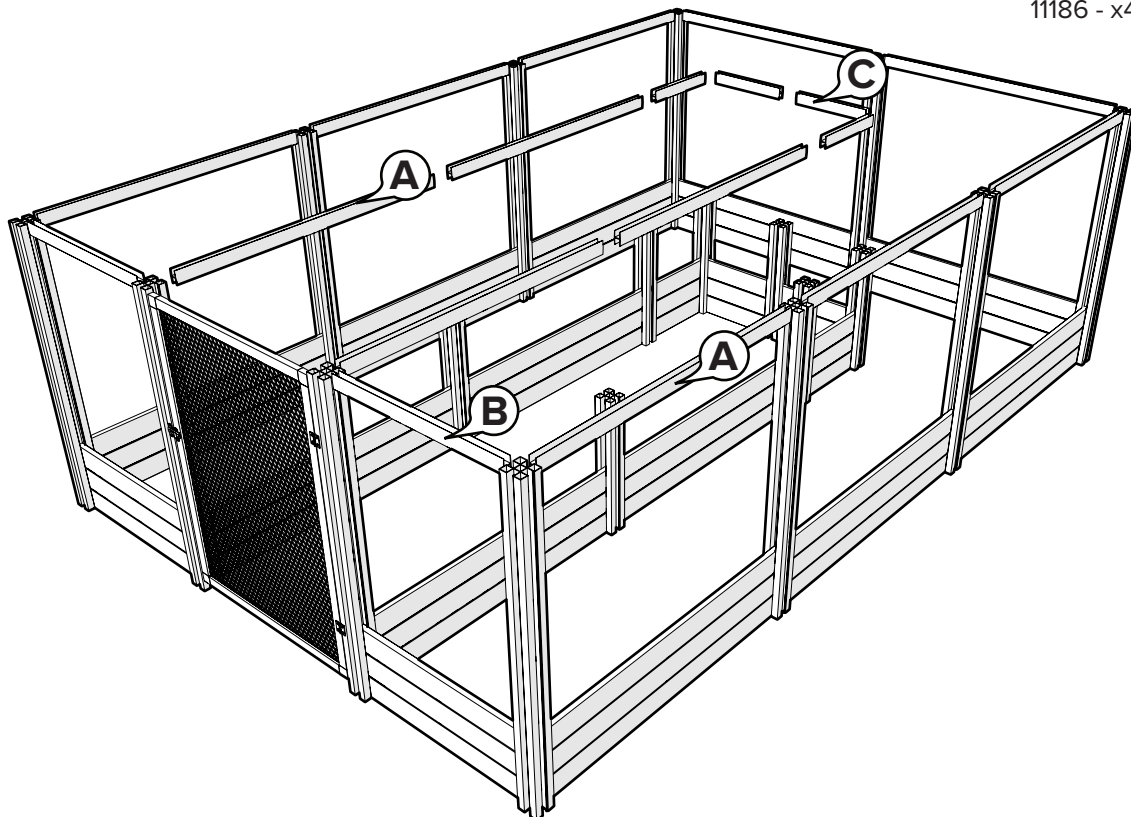

5

11170 - x12 (A)

11171 - x2 (B)

11172 - x4 (C)

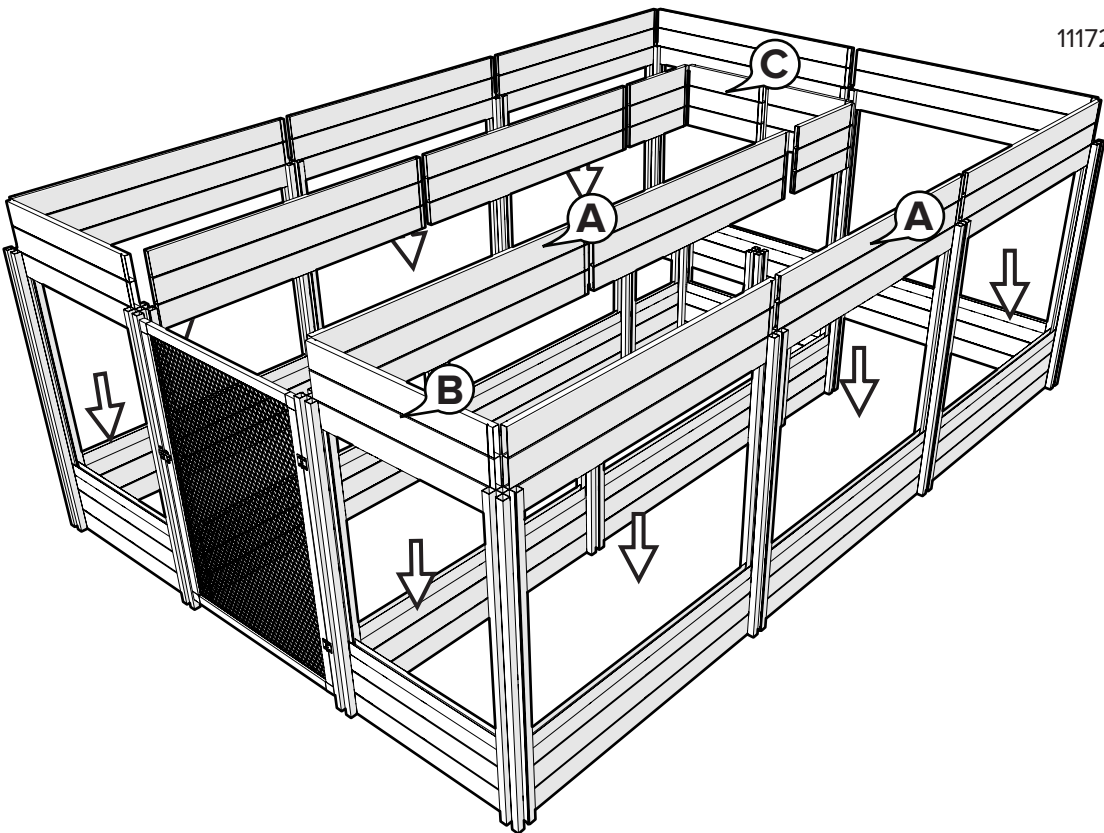

6

11171 - x5 (B)

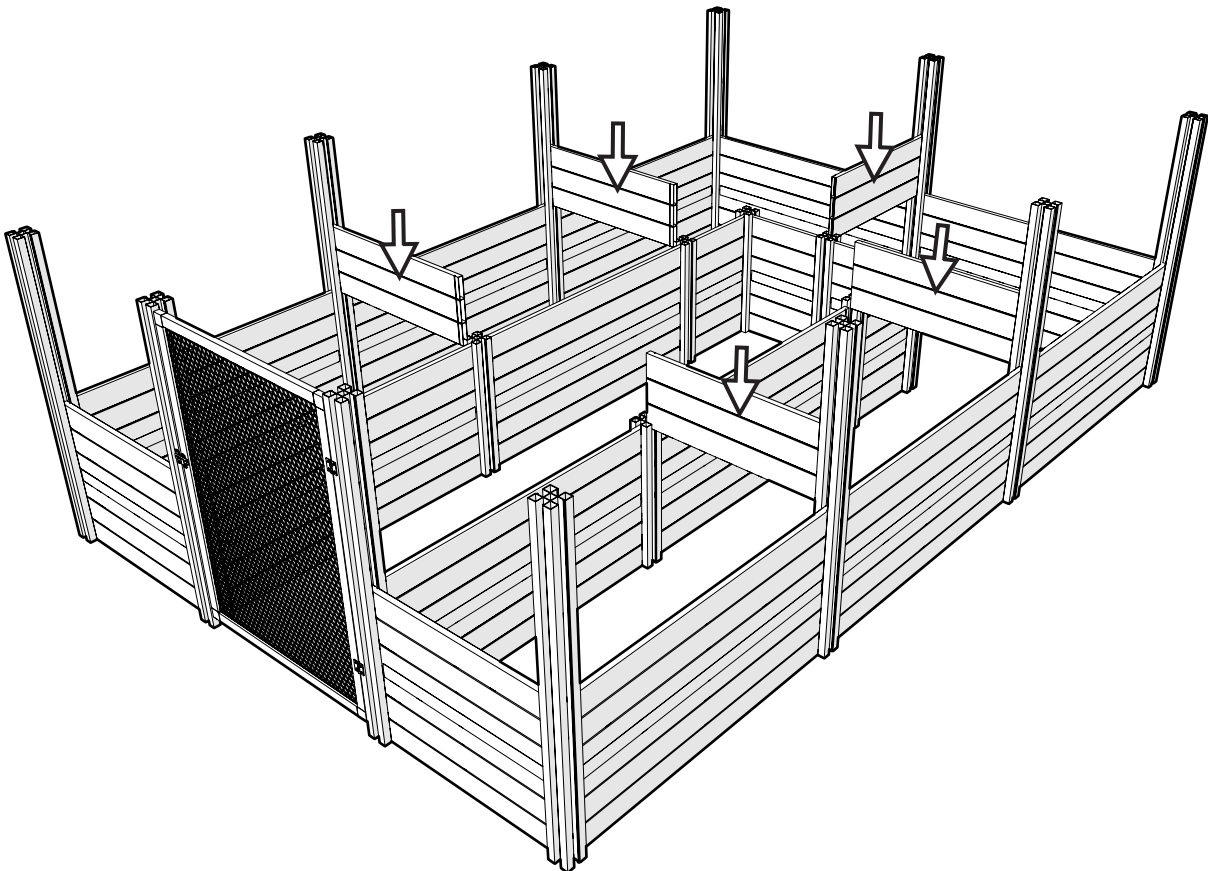

7

1173 - x8 (A)

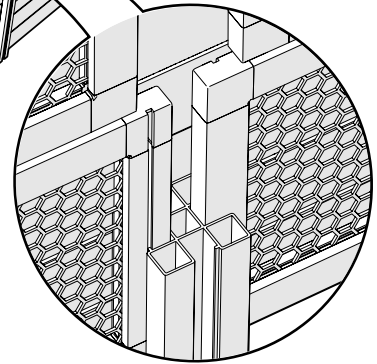
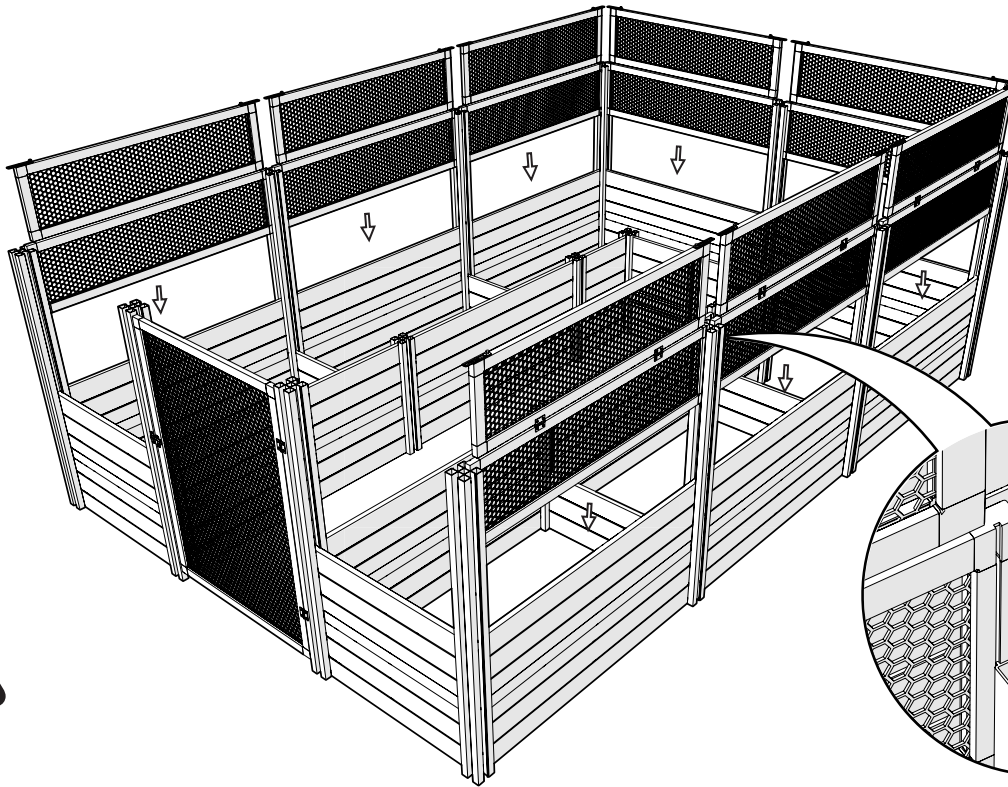
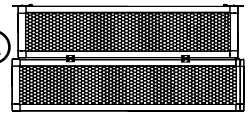

8

1174 - x2 (B)

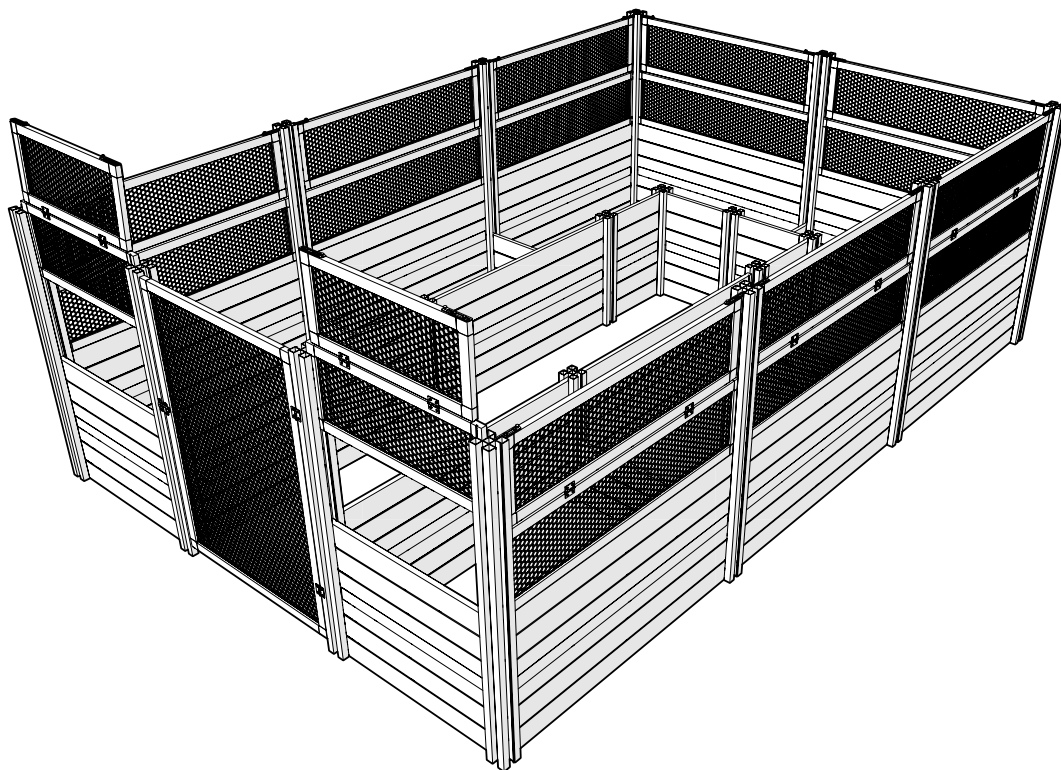
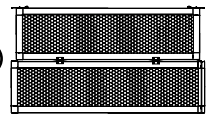

9

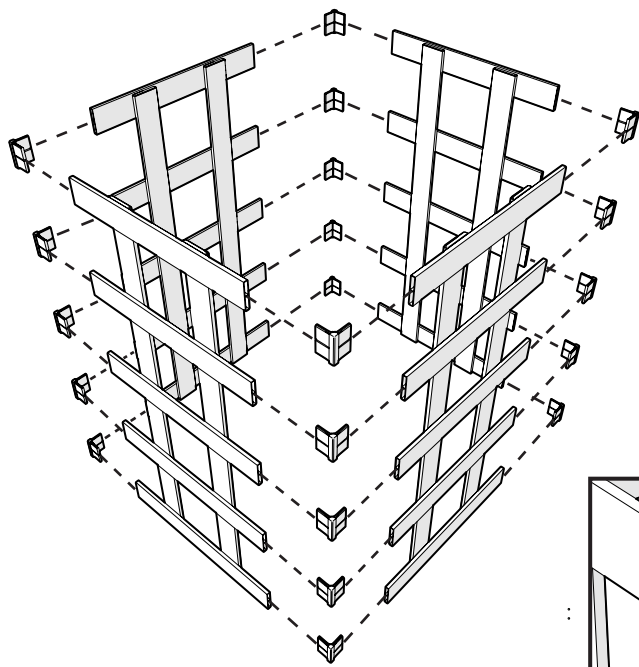

X4

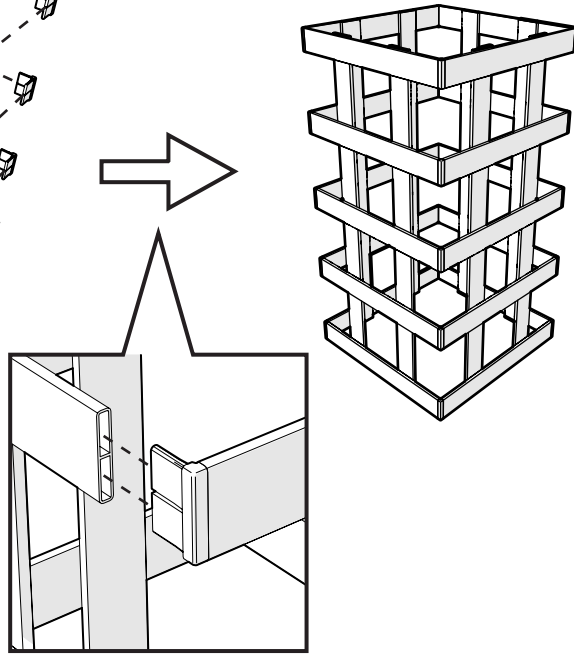
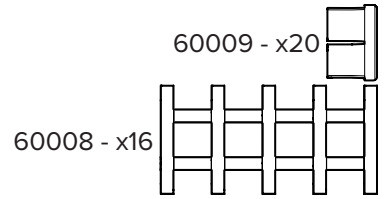

10

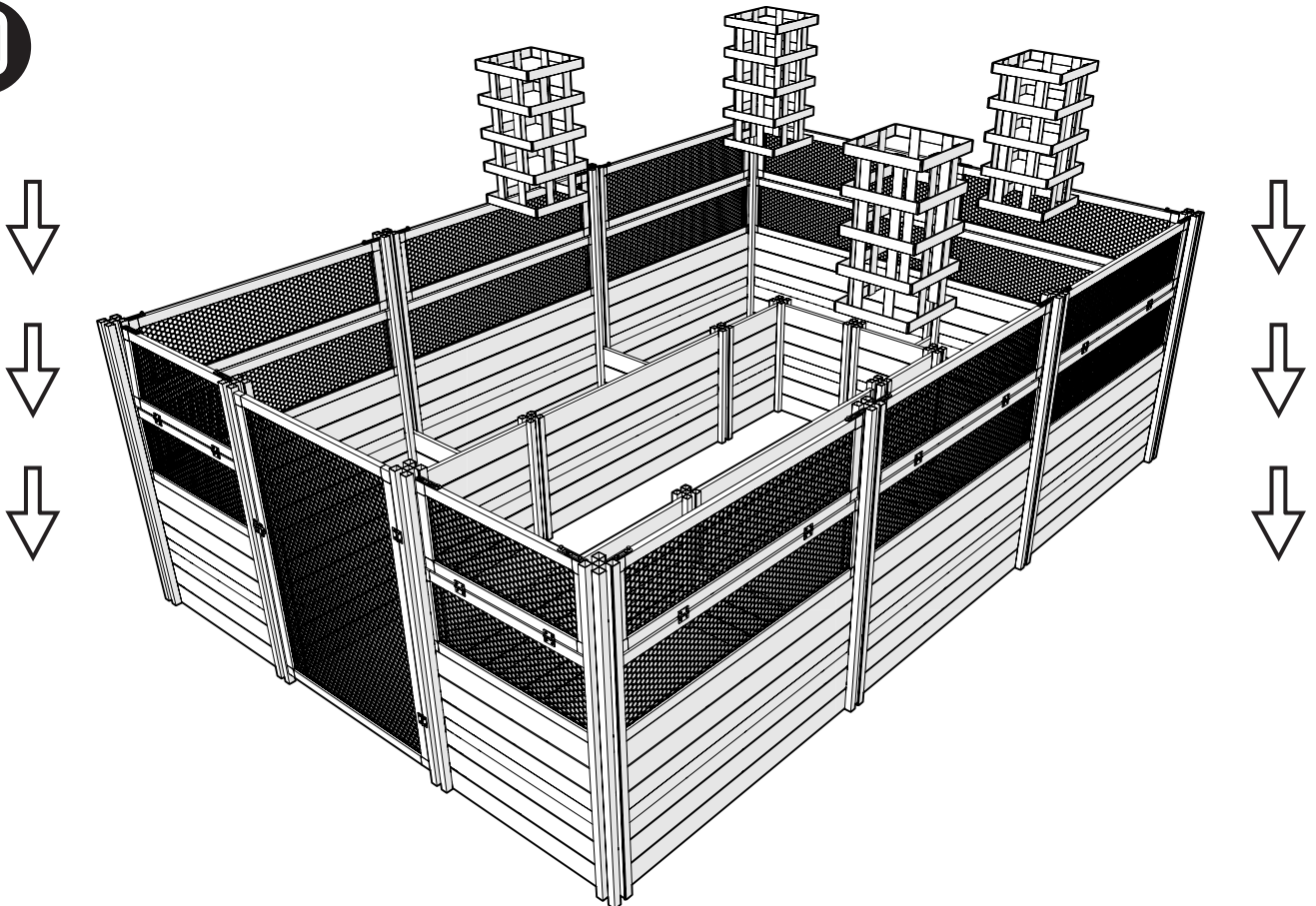



10766 - x18

