



ASSEMBLY GUIDE
GUIDE DE MONTAGE
GUÍA DE MONTAJE

CLASSIC
CLASSIQUE
CLÁSICO

5X5 BASE TRIM - 4 PACK

MOULURE DE BASE 5X5, PAQUET DE 4
PAQUETE DE 4 MOLDURAS BASE 5X5

BP81002

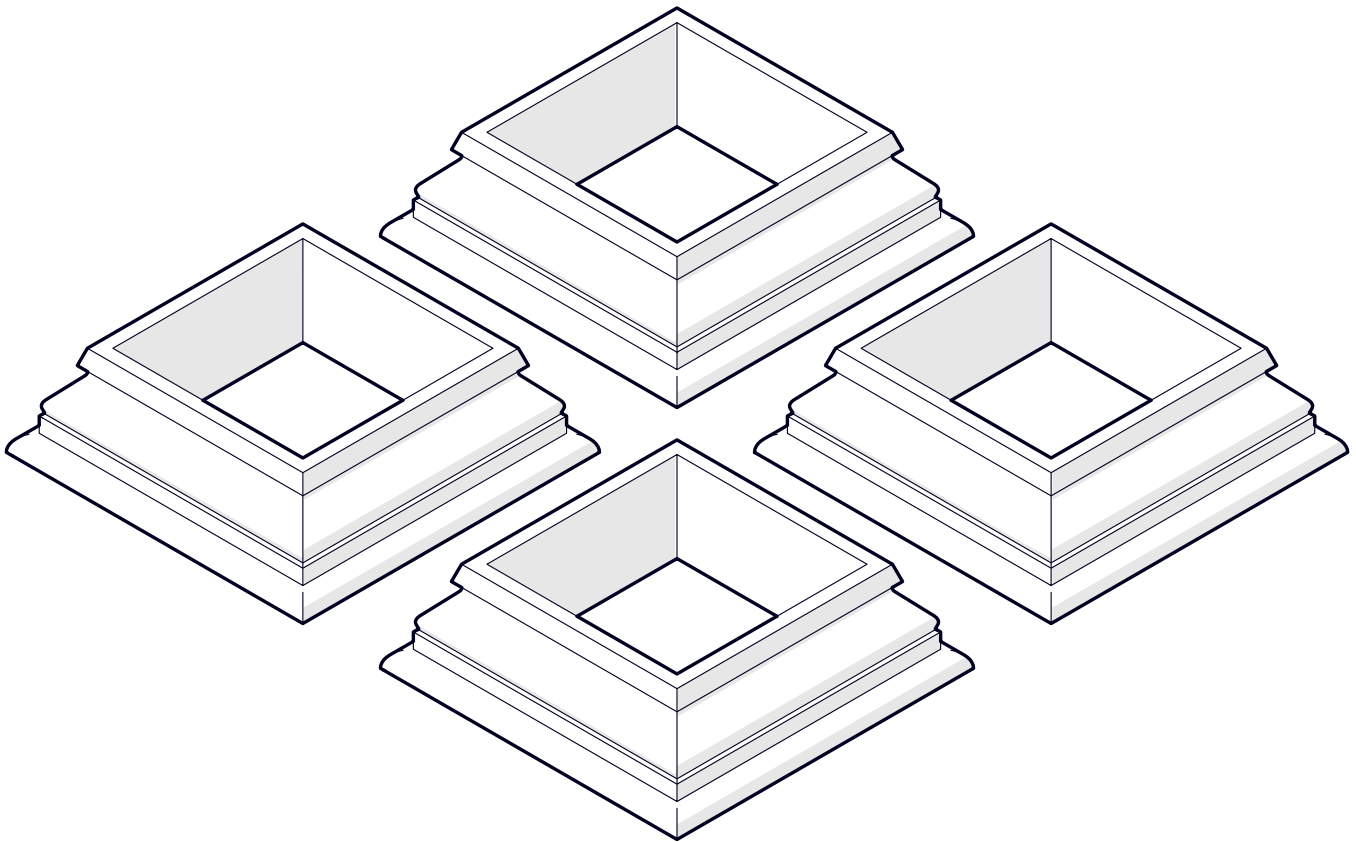

INSTALL THE BASE TRIMS IMMEDIATELY AFTER SLIDING THE VINYL POSTS OVER THE WOOD POSTS

INSTALLEZ LES MOULURES DE BASE IMMÉDIATEMENT APRÈS AVOIR GLISSÉ LES POTEAUX EN VINYLE SUR LES POTEAUX EN BOIS.
INSTALE LAS MOLDURAS DE BASE INMEDIATAMENTE DESPUÉS DE DESLIZAR LOS POSTES DE VINILO SOBRE LOS POSTES DE MADERA

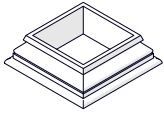

5" x 5" Base Trim
10916 x4

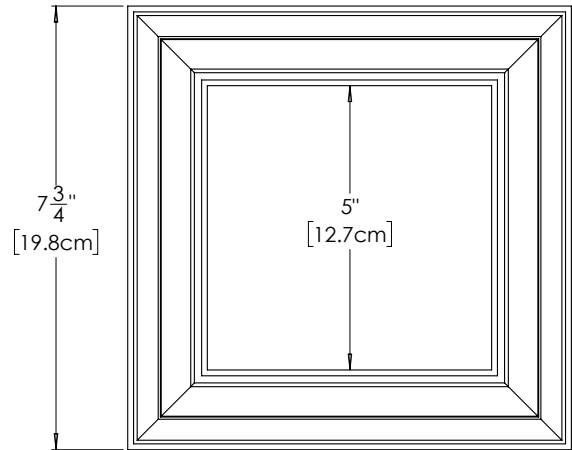
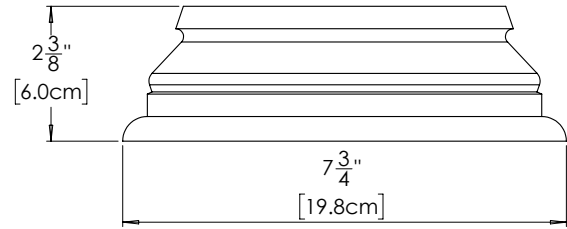
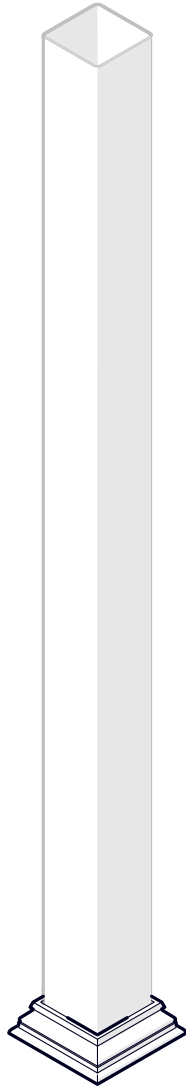
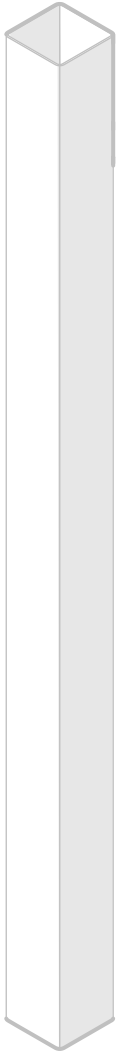
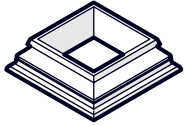
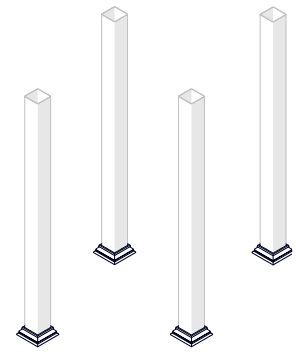

X4

