

SPECIAL *Event* SALES

CATALOGUE

Tents

Tables

Chairs

Linens

Led Bars

Patio Heaters

Catering Equipment

And More...



📍 7063 68 Ave NW
Edmonton AB T6B 3E3

☎ 780-430-8911

✉ sales@specialeventsales.com

📍 Unit 5, 454 Innovation Way
Woodstock ON N4V 0A2

☎ 416-613-2211

✉ sales@specialeventsales.com

www.specialeventsales.com

SPECIAL *Event* SALES

7063





Letter from the CEO

It has been an exciting time at Special Event Sales. In the fall of 2021, we moved to a new warehouse facility in East Edmonton. This new facility has helped increase the efficiency of our warehouse operations.

In the spring of 2022, we opened our Eastern Canadian warehouse in Woodstock, Ontario, which is close to Toronto. Having inventory in Eastern Canada makes one-day shipping to most of Ontario and Quebec a reality. Customers are also welcome to pick up inventory at either location.

We completely revamped our website and introduced live inventory availability along with online purchasing capabilities. Our new website is a great resource for equipment features, inventory availability, and pricing.

This new printed catalogue is the first that does not show pricing. With the events of the last few years, costs have been very volatile, and we encourage you to visit our website for current pricing. After a couple years of sky-high container costs, we are seeing rates come back down to reasonable levels.

Recently, we have happily reduced some of our prices as these shipping costs have come down.

We are proudly continuing to partner with Herculite for our tent vinyl. We have performed many tests this year for strength, abrasion

resistance, UV stability, and antimicrobial resistance and have found that the Herculite tent vinyl is vastly superior to offshore products. We are happy to provide these test results upon request.

New products this year include foldable LED bars, Resin crossback chairs, and Inflatable dome tents to name a few.

I would like to thank each customer for their continued support and wish you continued success in the future!

Sincerely,

A handwritten signature in blue ink that reads "Thomas Pollard".



Thomas Pollard
CEO
Special Event Sales

Contents



Tents

Clearspan Tents	6-9
Pole Tents	10-11
Marquee Frame Tents.....	12-13
Inflatable Tents	14
Pop-Up Tents.....	15
Pop-Up Tent Accessories.....	15
Marquee & Pole Tent Walls	16
Tent Accessories.....	17
Tent Lighting	18
Anchoring.....	19
Tent Heaters	21
Tarps	21
Tent Weighting	22-23



Tables

Plywood Tables	24-25
Farm Style Tables/Benches	25
Picnic Tables.....	25
Zown Plastic Tables.....	26-33
Table Parts	33
Stack Racks.....	34



Chairs

Folding Chairs.....	35-37
Crossback Chairs.....	39
Chiavari Chairs	40
Clear Chairs	40
Stools	41
Banquet Chairs	41-47

Louis XVI Banquet Chairs	43
Chair Parts.....	44
Zown Benches	48



Storage Carts

Chair Carts	48-49/51
Table Carts.....	50-51
Hand Trucks	52



Flooring

Carpets	52
Dance Floor Carts.....	53
Dance Flooring	53
Utility Flooring.....	54-56
Subfloor	57
Edge Trim	57



Pipe & Drape

Drape	58-59
Pipe.....	60



Linen

Tablecloths & Napkins.....	61
Spandex Covers	61

Zown Fabric Covers 61
 Chair Covers 62
 Table Skirts 62
 Table Clips 62



Led Bars & Furniture

LED Furniture & Accessories 67



Stanchions

Stanchions 68
 Stanchions Accessories 68



Catering Equipment

Glass Racks 69
 Food Carriers 70
 Beverage Servers..... 70
 Plate Carriers 71
 Catering Supplies 69-71
 Gel Fuel..... 72
 Tableware 73



Barbecues

Steakmate Barbecues 74-75
 Steakmate Griddles..... 76
 Steakmate Parts 76



Heaters

Zubri Patio Heaters..... 77
 Zubri Parts..... 77



Staging Platforms

Staging Platforms 78-79



Miscellaneous Items

Miscellaneous..... 80



BIG OR SMALL, WE HAVE THEM ALL!

CLEARSPAN | POLE | MARQUEE | POP-UP



CLEARSPAN

The big ones! With widths as wide as 50m (164') utilizing a modular bay system, these tents can be as large as you need them to be. Regardless of the size, the interior of the tent is free of posts and obstructions, giving you a wide open space to work with. Uses of these tents are limited only by your needs and have been used for weddings, corporate events, trade show venues, storage buildings, garages, ice rinks etc.



POLE

Pole tents are a classic; synonymous with weddings. The high peaks and flowing lines add a great visual appeal and focal point to festivals and other events. Available in 30', 40', 60' widths and expandable in 20' increments, these tents can accommodate events of any size.

BIG OR SMALL, WE HAVE THEM ALL!

CLEARSPAN | POLE | MARQUEE | POP-UP



MARQUEE

Marquee tents are the most versatile tent and the backbone of any tent rental operation. Available in sizes ranging from 10' x 10' up to a 34' hex they are perfect for most events. Using gutters, they can also be joined to create a bigger space. Durable and substantial yet easy to set up quickly with a small crew you can have the party started in no time.



POP-UP

Pop-up tents are the lightest duty tents we carry. Compact when collapsed and easy to set up in minutes with a helper or by yourself in a pinch, these tents are the go-to for temporary use. The tents are available in 10'x10' and 10'x20' sizes. We also offer full colour printing for the pop-up tops and walls to bring awareness to your business, event, or brand.





CLEARSPAN TENTS



Why Buy SES Clearspan?	German Clearspan Tent	SES Clearspan Tent
CNC Cut Fabrics	✓	✓
Hot Dipped Galvanized Steel Fittings	✓	✓
6062T6 Aluminum	✓	✓
100km/h Wind Rating	✓	✓
850g/m2 Roof Fabric	✗	✓
In House Extrusions	✗	✓
Fire Ratings for North America	Some	✓
Warranty	?	5 Years
Price*	\$\$\$	57% Less*

*Price comparison based on 25m x 20m structure

- All fabric conforms to NFPA 701, CAN/ULC S-109 and California State Fire Marshal fire flame retardant standards.
- All connectors and mounting bases are manufactured from zinc plated and hot dipped galvanized steel.
- Fabric is double PVC coated 850g/sqm (25oz).
- Tent structures are engineered to withstand winds of 100 kmph (62mph).
- We can provide engineered tent drawings upon request.
- Accessories sold separately.
- Liners available upon request.



CLEARSPAN TENTS (166mm Profile)



Most tents available for next day shipping! Packages include the entire tent, even the walls.
Need something bigger? Give us a call for your best price.

ITEM	SKU#
9M x 5M Plain Walls	587-2990
9M x 10M Plain Walls	587-3000
9M x 15M Plain Walls	587-3010
9M x 20M Plain Walls	587-3020
9M x 25M Plain Walls	587-3030
9M x 30M Plain Walls	587-3040
9M x 35M Plain Walls	587-3060
9M x 40M Plain Walls	587-3070
9M x 45M Plain Walls	587-3080
9M x 50M Plain Walls	587-3090
9M x 55M Plain Walls	587-3100
9M x 60M Plain Walls	587-3110
12M x 5M Plain Walls	587-3210
12M x 10M Plain Walls	587-3220
12M x 15M Plain Walls	587-3230
12M x 20M Plain Walls	587-3240
12M x 25M Plain Walls	587-3250
12M x 30M Plain Walls	587-3260
12M x 35M Plain Walls	587-3270
12M x 40M Plain Walls	587-3280
12M x 45M Plain Walls	587-3290
12M x 50M Plain Walls	587-3300
12M x 55M Plain Walls	587-3310
12M x 60M Plain Walls	587-3320
15M x 5M Plain Walls	587-3420
15M x 10M Plain Walls	587-3430
15M x 15M Plain Walls	587-3440
15M x 20M Plain Walls	587-3450
15M x 25M Plain Walls	587-3460
15M x 30M Plain Walls	587-3470
15M x 35M Plain Walls	587-3480
15M x 40M Plain Walls	587-3490
15M x 45M Plain Walls	587-3500
15M x 50M Plain Walls	587-3510
15M x 55M Plain Walls	587-3520
15M x 60M Plain Walls	587-3530
18M x 5M Plain Walls	587-3650
18M x 10M Plain Walls	587-3660
18M x 15M Plain Walls	587-3670
18M x 20M Plain Walls	587-3680
18M x 25M Plain Walls	587-3690
18M x 30M Plain Walls	587-3700
18M x 35M Plain Walls	587-3710
18M x 40M Plain Walls	587-3720
18M x 45M Plain Walls	587-3730
18M x 50M Plain Walls	587-3740
18M x 55M Plain Walls	587-3750
18M x 60M Plain Walls	587-3760
18M x 65M Plain Walls	587-3770
18M x 70M Plain Walls	587-3780

ITEM	SKU#
9M x 5M Window Walls	587-2991
9M x 10M Window Walls	587-3001
9M x 15M Window Walls	587-3011
9M x 20M Window Walls	587-3021
9M x 25M Window Walls	587-3031
9M x 30M Window Walls	587-3041
9M x 35M Window Walls	587-3061
9M x 40M Window Walls	587-3071
9M x 45M Window Walls	587-3081
9M x 50M Window Walls	587-3091
9M x 55M Window Walls	587-3101
9M x 60M Window Walls	587-3111
12M x 5M Window Walls	587-3211
12M x 10M Window Walls	587-3221
12M x 15M Window Walls	587-3231
12M x 20M Window Walls	587-3241
12M x 25M Window Walls	587-3251
12M x 30M Window Walls	587-3261
12M x 35M Window Walls	587-3271
12M x 40M Window Walls	587-3281
12M x 45M Window Walls	587-3291
12M x 50M Window Walls	587-3301
12M x 55M Window Walls	587-3311
12M x 60M Window Walls	587-3321
15M x 5M Window Walls	587-3421
15M x 10M Window Walls	587-3431
15M x 15M Window Walls	587-3441
15M x 20M Window Walls	587-3451
15M x 25M Window Walls	587-3461
15M x 30M Window Walls	587-3471
15M x 35M Window Walls	587-3481
15M x 40M Window Walls	587-3491
15M x 45M Window Walls	587-3501
15M x 50M Window Walls	587-3511
15M x 55M Window Walls	587-3521
15M x 60M Window Walls	587-3531
18M x 5M Window Walls	587-3651
18M x 10M Window Walls	587-3661
18M x 15M Window Walls	587-3671
18M x 20M Window Walls	587-3681
18M x 25M Window Walls	587-3691
18M x 30M Window Walls	587-3701
18M x 35M Window Walls	587-3711
18M x 40M Window Walls	587-3721
18M x 45M Window Walls	587-3731
18M x 50M Window Walls	587-3741
18M x 55M Window Walls	587-3751
18M x 60M Window Walls	587-3761
18M x 65M Window Walls	587-3771
18M x 70M Window Walls	587-3781

See page 14 for tent accessories.





CLEARSPAN TENTS

12mx25m Party tent					
Main Profile Size					
Purpose	Leg, Roof Beam & Gable Pole	Eaves Rail	Tension Bar	Purlin	Trusses

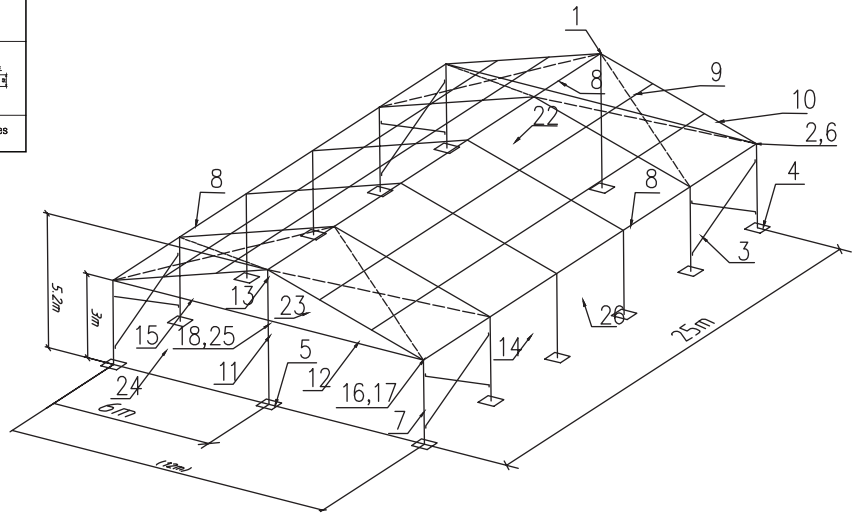
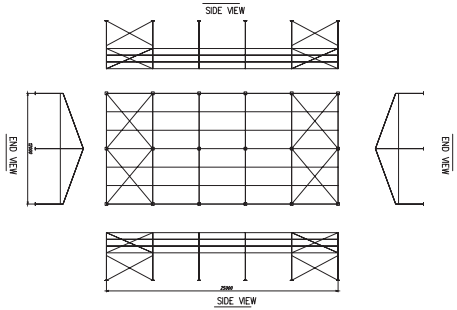

Revision info					Consultant Stamp		Dwg No.		SES-B1225	
Rev.	Revised matter	Drawn	Approved	Date	 Drawn By: _____ Manager: _____ Checked: _____ Approved: _____		Mat' 1		6N01-T6 JIS H4100-1982	
△	ISSUED FOR CONSTRUCTION		RMB	06.03.13			Rev.	A	Item	
△	UPDATE CODES		RMB	01.01.20			Wt.	/ kg/m	Unit	MM
							Scale	1:1	Date	01-JAN-2020

Item	Name of part	Size(mm)	quantit
28	hexagonal screw	M12X120	6pcs
27	hexagonal screw	M16X110	82pcs
26	standard transparent window		10pairs
25	tension		2pcs
24	sidewall transparent window		4pairs
23	triangle pannel		2pairs
22	roof cover		5pcs
21	roof wire	Ø8X8615	4pairs
20	sidewall window tension rail	1"×4500 galv steel tube	4pcs
19	standard window tension rail	1"×5000 galv steel tube	10pcs
18	direct joints at vertical rail	50x30x500	10pcs
17	hooked joints of rail	70x30x390	4pcs
16	triangle rail joints at both ends	70x30x500	4pcs
15	triangle pannel tension rail	80X40X5900	4pcs
14	cover tension rail	80X40X4900	10pcs
13	mid insert of connection friangle pvc	48X20X2350	2pcs
12	side-eave beam	102×85×5710	4pcs
11	gable pole	166×87×4740	2pcs
10	roof beam	166×87×5800+2300	12pcs
9	purlin	60×60×4912	20pcs
8	eave beam	102×85×4912	15pcs
7	leg	166×87×2735	12pcs
6	tension pole	M18X350	12pcs
5	gable pole base plate	300×300×100	2pcs
4	base plate	300×300×100	12pcs
3	trusses	50×60×5503	4pairs
2	angle insert		12pcs
1	top joints		6pcs
Item	Name of part	Size(mm)	quantit

Remarks
<p>ANCHOR REQUIREMENTS @ 100 kph</p> <p>Uplift Forces: 332 kN Horizontal Forces: 125 kN Tent Weight: 2458kg Min Ballast/ Leg: 2417 kg</p>
<p>Consultant Scope of Work is Limited to:</p> <p>1) Scope of work is limited to the review of structure performance in wind gusts not exceeding the max wind speed as defined below.</p> <p>2) Scope of work does not included physical testing of the tent materials, review of site conditions, tent erection procedures or inspection of the erected structure.</p> <p>3) Scope of work shall not be construed as approval or guarantee that the erected tent structure will perform safely or otherwise for any particular use or site.</p> <p>4) The consultant will not be held liable for injury or property damage resulting from any and all use or application of the tent structure.</p> <p>Winds loads : NBC2019-AB, NBC2019 & ASCE 7-10</p> <p>Exposure: C Category: 3 Max q: 0.5 kPa Max V: 100 kph Snow Loads: None</p>

CLEARSPAN TENTS (81mm Profile)



Smaller scale, big value!

These tents are the same style as our 166mm profile tents but with a lighter frame appropriate to their size. All packages include all frame and fabric pieces required for setup; anchors sold separately. A lower eave height of 2.4m allows these tents to mate well with our line of Marquee tents.

ITEM	SKU#
6M x 3M Plain Walls	587-1500
6M x 3M Window Walls	587-1510
6M x 6M Plain Walls	587-1520
6M x 6M Window Walls	587-1530
6M x 9M Plain Walls	587-1540
6M x 9M Window Walls	587-1550
6M x 12M Plain Walls	587-1560
6M x 12M Window Walls	587-1570
6M x 15M Plain Walls	587-1580
6M x 15M Window Walls	587-1590
6M x 18M Plain Walls	587-1600
6M x 18M Window Walls	587-1610
6M x 21M Plain Walls	587-1620
6M x 21M Window Walls	587-1630
6M x 24M Plain Walls	587-1640
6M x 24M Window Walls	587-1650
6M x 27M Plain Walls	587-1660
6M x 27M Window Walls	587-1670
6M x 30M Plain Walls	587-1680
6M x 30M Window Walls	587-1690





POLE TENTS

Defined by their sweeping high peaks and graceful curves, Special Event Sales Pole Tents are reminiscent of circus tents of old and bring a feeling of nostalgia to any event.



ITEM	SKU#
30' x 40'	588-0010
30' x 60'	588-0020
30' x 80'	588-0030
30' x 100'	588-0040
30' x 120'	588-0050
40' x 40'	588-0100
40' x 60'	588-0110
40' x 80'	588-0120
40' x 100'	588-0130
40' x 120'	588-0140
40' x 140'	588-0160
40' x 160'	588-0170
40' x 180'	588-0180
40' x 200'	588-0190
40' x 220'	588-0200
60' x 40'	588-0300
60' x 60'	588-0310
60' x 80'	588-0320
60' x 100'	588-0330
60' x 120'	588-0340
60' x 140'	588-0350
60' x 160'	588-0360
60' x 180'	588-0370
60' x 200'	588-0380
60' x 220'	588-0390
60' x 240'	588-0400
60' x 260'	588-0410
60' x 280'	588-0420



POLE TENTS

Available in 30', 40' and 60' widths, with lengths that are easily adjusted by adding 20' mid-sections. Window walls, plain walls and accessories sold separately.

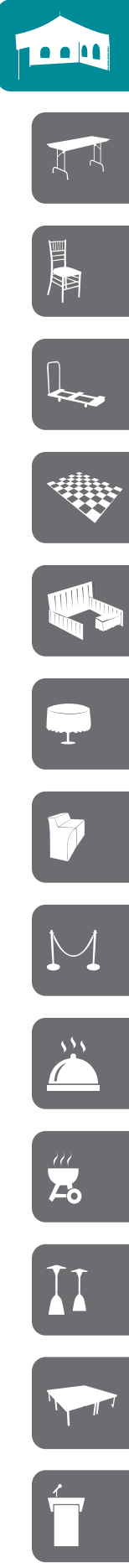



MARQUEE FRAME TENTS

Our marquee frame tents have been refined by our rental division to ensure ease of setup, ease of storage and durability that will last for many years.

Each tent comes with the following features:

- Industry exclusive quick adjust center pole.
- 16oz opaque white top that is mildew resistant.
- Custom USA made Herculite Architent vinyl.
- Storage bag for top.
- Complete frame made from anodized aluminum and electroplated steel components.
- Complete wall hanging cable system featuring aircraft grade stainless steel turnbuckles that are seize resistant.
- Convenient 3/4" plywood storage box for small parts that are stackable, have heavy duty chest handles and have tent size clearly marked. These boxes are invaluable for rental companies to keep their inventory organized.



WHY BUY SES MARQUEE?	CANADIAN MARQUEE TENT	SES MARQUEE TENT
16oz Fabric	✓	✓
Pipe Sidewall Thickness	2.5mm	2.8mm
CNC Cut Tops	×	✓
In House Extrusions	×	✓
Infinitely Adjustable Centrepole	Incremental	✓
SS Turnbuckles	×	✓
Wall Cables Included	×	✓
Storage Box Included	×	✓
Warranty	?	5 Years
Lower Price	×	✓

MARQUEE FRAME TENTS



ITEM	SKU#
10' x 10'	589-0010
10' x 20'	589-0020
10' x 30'	589-0022
10' x 40'	589-0024
15' x 15'	589-0030
20' x 20'	589-0040
20' x 30'	589-0050
20' x 40'	589-0060
30' x 30'	589-0070
17' x 20' Hex	589-0080
34' x 40' Hex	589-0090

Features:

- Durable and beautiful.
- Universal parts that are common to most tent sizes.
- Open floor plans with no obstructions; center pole is supported by the cross cables.
- Tents can be joined together to create many different layouts.
- State of the art manufacturing facility. Fabric is CNC cut and extrusions are made in house.
- Steel components robotically welded.
- Tents are engineered to conform with North American Building Codes.
- Engineered drawings for other provinces, states or countries can be supplied upon request.
- Tent fabric meets all Canadian and US fire retardant codes: CAN ULC-S109, NFPA 701, and California State Fire Marshal.





INFLATABLE TENTS

Inflatable Tents

New to SES! We now offer inflatable dome tents. These tents are supported by air and can be completely set up from the ground. The geodesic shape makes an excellent focal point and change of pace from traditional festival tents.



6m Dome Tent / Stage Cover

586-1030



12m Dome Tent

586-1010



15m Dome Tent

586-1000

POP-UP TENTS



Heavy Duty Pop-Up Tents

This is the world's premier pop-up tent. Featuring metal corner connectors and a 50mm x 2mm hexagonal tubular frame that is the best in the industry.

Value Series Pop-Up Tents

The 10' x 10' value series pop-up tent has been brought to market to satisfy those customers that require an economical, yet sturdy tent.

Custom Tops

Special Event Sales is now proud to offer custom tops for our 10' x 10' and 10' x 20' pop-up tents!

Build your brand awareness at trade shows, charity events and company events. Please contact us for more information and pricing.



ITEM	SKU#
10' x 10' HD Aluminum Frame	586-0010
10' x 20' HD Aluminum Frame	586-0005
10' x 10' SES Value Series Steel Pop-Up Frame	586-0015
10' x 10' White Top	586-0100
10' x 10' Black Top	586-0110
10' x 10' Yellow Top	586-0115
10' x 10' Royal Blue Top	586-0120
10' x 10' Red Top	586-0130
10' x 20' White Top	586-0135
10' x 20' Black Top	586-0137
10' x 10' Custom Top	586-0132
10' x 20' Custom Top	586-0139

POP-UP TENT ACCESSORIES

ITEM	SKU#
10' Plain White Wall	586-0020
10' Plain Black Wall	586-0025
10' White Window Wall	586-0030
10' White Gutter	586-0140
15kg Cast Steel Weight	586-0040
Sand Bag	586-0045
Rubber Weight	540-0012
50mm Frame Connector	586-0070
HD Aluminum Foot (Steel)	586-0200
Center Pole Top Cap (Plastic)	586-0190
HD Leg Bracket w/Pull Ring	586-0180
HD Aluminum Leg Top	586-0210
HD Aluminum Slider	586-0220

HD Aluminum Pull Ring	586-0230
HD Aluminum Connector	586-0240
Value Series Top 4 Way Connector	586-0400
Value Series Bottom 4 Way Connector	586-0410
Value Series Top Leg Bracket	586-0420
Value Series Leg Slider Bracket	586-0430
Value Series Leg Pull Ring Bracket	586-0440
Value Series Center Pole Top Cap (Plastic)	586-0450
Value Series Connector Bracket	586-0460
Value Series Pivot Bracket	586-0470
Value Series End Plug	586-0480
Value Series Center Leg Slider Bracket	586-0490
Value Series Center Top Leg Bracket	586-0500





MARQUEE - POLE TENT WALLS



ITEM	SKU#
8' x 10' Window Rod Tensioned Wall	589-0600
8' x 10' Window Standard Wall	589-0605
8' x 10' Plain Rod Tensioned Wall	589-0500
8' x 10' Plain Standard Wall	589-0505
8' x 15' Window Rod Tensioned Wall	589-0610
8' x 15' Window Standard Wall	589-0615
8' x 15' Plain Rod Tensioned Wall	589-0510
8' x 15' Plain Standard Wall	589-0515
8' x 20' Window Rod Tensioned Wall	589-0620
8' x 20' Window Standard Wall	589-0625
8' x 20' Plain Rod Tensioned Wall	589-0520
8' x 20' Plain Standard Wall	589-0525
8' x 30' Window Rod Tensioned Wall	589-0630
8' x 30' Window Standard Wall	589-0635
8' x 30' Plain Rod Tensioned Wall	589-0530
8' x 30' Plain Standard Wall	589-0535
10' x 10' Plain Rod Tensioned Wall	589-0540
10' x 20' Plain Rod Tensioned Wall	589-0550
8' x 20' Port Hole Rod Tensioned Wall	589-0621
8' x 20' Hearts Rod Tensioned Wall	589-0622
8' x 20' Love Rod Tensioned Wall	589-0623



Plain Rod Tensioned Wall



Window Rod Tensioned Wall



8' x 10' Café Wall

589-0640

8' x 20' Café Wall

589-0650

8' x 15' Café Wall

589-0645

8' x 30' Café Wall

589-0660



8' x 20' "Hearts" Wall

589-0622



8' x 20' "Love" Wall

589-0623

TENT ACCESSORIES



2.5" - 5" Center Pole Clamp Bracket

597-0082

This simple clamp bracket was designed by us to easily fit lighting on center poles in most tents. Manufactured from steel and zinc plated, it will last you for years. Wing nuts are supplied so you don't need tools for installation. To be used in conjunction with our LED lighting system.

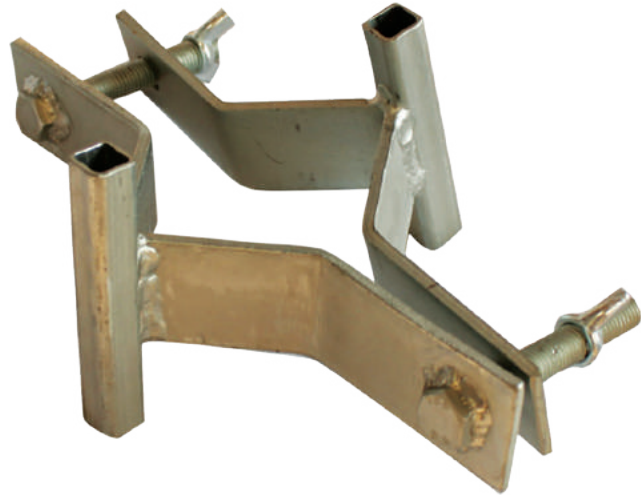

ITEM	SKU#
Center Pole Dolly and Mover	584-0120
Hanging Bracket Keder Clamp	584-0100
10' Gutter Joiner	589-1500
15' Gutter Joiner	589-1510
20' Gutter Joiner	589-1520
30' Gutter Joiner	589-1531
40' Gutter Joiner	589-1535
Weight Plate for Marquee	589-0700
Adjustable Center Pole Base for Marquee Tents	589-1305
Maasdam Power Pull 1 Ton Hoist	589-1440
Lift Tool Aluminum	589-1430
V Tool	589-1420

Center Pole Tool	589-1410
1oz Vinyl Pinhole Repair Liquid	589-1580
350lbs Weight Cover	589-2100
500lbs Weight Cover	589-2110
700lbs Weight Cover	589-2120
Weight Plate for Clearspan	587-5520
Universal Tent Door	589-1700
Tent Jack	589-1435
Vinyl HH-66 Contact Cement 8oz	589-1581
Vinyl HH-66 Contact Cement 128oz	589-1582
Purlin Tool for Clearspans	587-1445
Porta Exit Light with Case	582-0120
Puller Kit for Clearspan Roof Panels	587-5540



Porta Exit Light with Case



Puller Kit



Vinyl Pinhole Repair Liquid



Weight Plate





TENT LIGHTING

Cafe Lights

These cafe lights are ideal for decorating your event. They can be used inside tents, on backdrops or pillars or wherever your imagination takes you. The cords are white and bulbs are clear and they can be ganged together to form a long line. Choose a length that best suits your event!



ITEM	SKU#
25' string with 25 sockets	597-0150
50' string with 50 sockets	597-0160
100' string with 100 sockets	597-0170



LED Clear Cafe Round Bulb

597-0185

1W 50mm - 30,000 Hours Life.



Clear Cafe Round Bulb

597-0180

7W 50mm - Incandescent.
130 Volt - 3000 Hours Life.



HD 70W LED Tent Light

597-0084

Replaces 500W Halogen Meets ETL (US) and CETL (CAN) electrical standards



String Lights

50' Long 5 Light White
597-0060

100 Long 10 Light White
597-0070

These are a great light cord for the event industry or anywhere that you need temporary lighting. Bulb holders are spaced every 10' and come with a protective wire cage to fit around each bulb. Cords are UL and OSHA approved and are built to the highest quality.



ANCHORING



ITEM	SKU#
5/8" x 30" Auger Stake	589-1402
3/4" x 24" Double Head Stake	589-1403A
3/4" x 24" Side Hook Stake	589-1404
3/4" x 36" Double Head Stake (LG)	589-1403
1" x 42" Double Head Stake (2")	589-1401
1" x 60" Double Head Stake (3")	589-1398
18" Spiral Anchor Penetrator	589-1406
26" Spiral Anchor Penetrator	589-1407
Case of 512 3/4" Plug-R	589-1550
Case of 320 7/8" Plug-R	589-1560
Redi Driver Boss	589-1561
Redi Driver Storage Case	589-1563
Jackjaw 302 Stake Puller 29"	589-1455
Jackjaw 502 Stake Puller Extender	589-1460
Jackjaw 514 Stake Puller Load Cell	589-1465
Jackjaw Tent Stake Adapter	589-1470
Manual Small Mouth Stake Puller	589-1450
Large Attachment for Manual Stake Puller	589-1451
Stake Driver Head 1 1/8" Shank, 2" Cup	589-1567
Stake Driver Head 1 1/8" Shank 2 1/2" Cup	589-1566
Stake Puller Green Monster Hydraulic	589-1485
Stake Puller Manual Basic	589-1480



REDI DRIVER



Stake Puller
Green Monster
Hydraulic



Side Hook
Stake

Auger
Stake





TENT HEATERS



Premier 350 Heater



Premier 80 Heater



Premier 170 With Diffuser Kit



White Duct Kit

ITEM	SKU#
Premier 40 Propane L.B. White Heater	584-0005
Premier 80 Propane L.B. White Heater Dual Fuel	584-0011
Premier 170 Propane L.B. White Heater Dual Fuel	584-0021
NG Conversion Kit for Premier 80	584-0060
NG Conversion Kit for Premier 170	584-0065
18" x 12' Grey Duct Kit	584-0045
12" x 12' White Duct Kit	584-0035
Premier 40 Heater Diffuser Kit	584-0006
Premier 80 Heater Diffuser Kit	584-0015
Premier 170 Heater Diffuser Kit	584-0025
End Diffuser for 12" Duct	584-0030
Thermostat	584-0070

TARPS

Protect your tent investment during erection by using our exclusive ground tarps. These tarps are lightweight and allow water to flow through ensuring protection for your tent tops and quick drying when wet.



ITEM	SKU#
25' x 25' Standard Tarp	581-0010
25' x 25' Heavy Duty Mesh Tarp	581-0100
30' x 50' Standard Tarp	581-0020
30' x 50' Heavy Duty Mesh Tarp	581-0110
40' x 40' Standard Tarp	581-0030
40' x 40' Heavy Duty Mesh Tarp	581-0120

Standard

- 110g Fabric
- Grommets every 5'

Heavy Duty

- PVC Mesh
- 204g Fabric
- Grommets every 5'

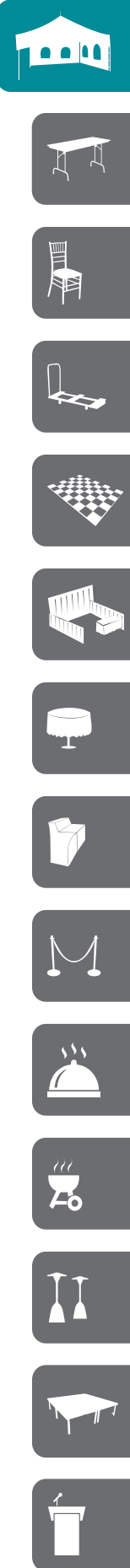



TENT WEIGHTING

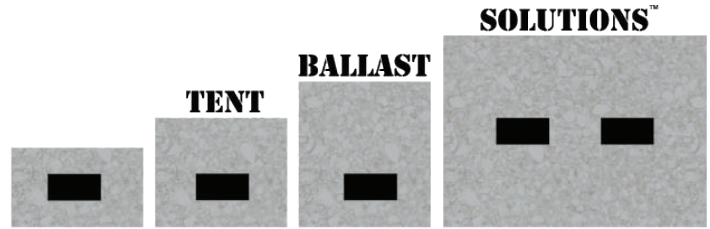
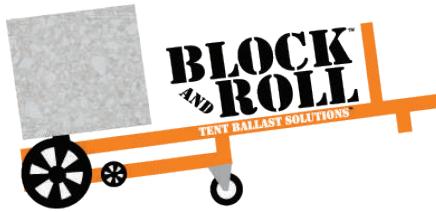

Block And Roll Tent Ballast Solutions provides an innovative way to manage and move cement tent ballasts.

The system allows for easy and safe handling of heavy cement blocks with or without a forklift. Block And Roll blocks can be stacked for increased weight and easy storage. We offer equipment to handle blocks from 350lbs to 700lbs with out the use of a fork lift. Our weights have multiple tie off points for secure tensioning.

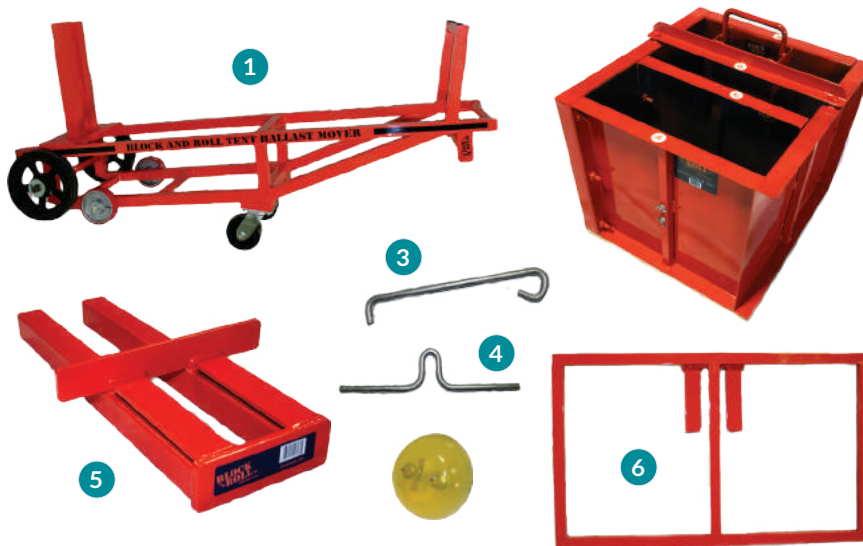

Block and Roll Starter Kit

Includes

- 1. 1 Mover Cart
- 2. 1 Multi Block Form 700 Kit
- 3. 25 Front Hooks
- 4. 25 Top Hooks
- 5. 1 EZ Stacker
- 6. 1 Carry All

Off Road Edition Block and Roll Started Kit

Includes

- 1. 1 Off Road Mover Cart
- 2. 1 Multi Block Form 700 Kit
- 3. 25 Front Hooks
- 4. 25 Top Hooks
- 5. 1 EZ Stacker
- 6. 1 Carry All

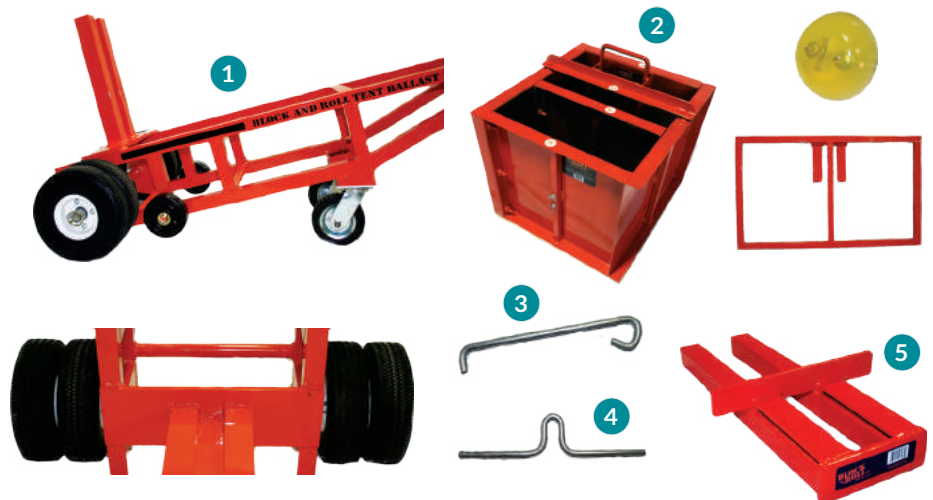

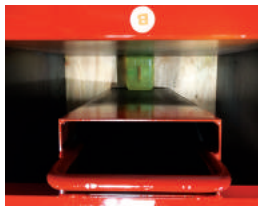

Multi Block Form 700 Kit

Use this form to make 350lbs, 500lbs or 700lbs Blocks.

Includes

1. 2 Rubber Knockout
2. 1 Fork Pocket 20
3. 1 Form Divider
4. 1 Plywood Base



Mover Cart Standard



Mover Cart Off Road



Mover Cart 350



Stake Block Puller



EZ Stack 350



5" Rubber Knockout



4" Rubber Knockout



Tie Off Hook



Tie Off Rigid Loop



Lace-Point Tension Tent Bracket

ITEM	KEY#
4" Round Reusable Rubber Bolt-On Knockout'	582-0070
5" Round Reusable Rubber Bolt-On Knockout'	582-0080
B&R Front Tie Off Rigid Loop (300lb - 700lb)	582-0090
B&R Front Tie Off Hook (300lb - 700lb)	582-0100
Lace-Point Tension Tent Bracket w\30" Steel Table"	582-0130





PLYWOOD TABLES



- Our premium plywood tables are manufactured from the highest quality birch plywood specifically selected for its strength, non-warping characteristics and long term durability.
- The plywood is bonded with waterproof exterior grade glue making the tables an excellent choice for outdoor use.
- We add a high grade polyurethane coating to the top and bottom of the table to protect and enhance the appearance.
- We have extensively tested and used these tables in our rental fleet before releasing them for sale, and believe this is the best plywood folding table money can buy.



Rectangular Birch Plywood Tables



ITEM	SKU#
12" x 72" Birch Plywood Bar Top	500-0105
12" x 96" Birch Plywood Bar Top	500-0114
18" x 72" Birch Plywood Banquet Table	500-0088
18" x 96" Birch Plywood Banquet Table	500-0089
24" x 48" Birch Plywood Table	500-0091
24" x 72" Birch Plywood Table	500-0145
24" x 96" Birch Plywood Table	500-0150
30" x 48" Birch Plywood Banquet Table	500-0090
30" x 72" Birch Plywood Banquet Table	500-0100
30" x 96" Birch Plywood Banquet Table	500-0110
42" x 96" Birch Plywood	500-0109
Glide for Banquet Table (100)	500-0205

Refer to Carts

Round Birch Plywood Tables



ITEM	SKU#
48" Round Birch Plywood Table	500-0115
60" Round Birch Plywood Table	500-0120
66" Round Birch Plywood Table	500-0125
72" Round Birch Plywood Table	500-0130
48" Half Round Folding Table	500-0116
60" Half Round Folding Tables	500-0121

Refer to Carts

Other Birch Plywood Tables



ITEM	SKU#
60" Square Plywood Table	500-0135
60" x 30" Serpentine Birch Plywood Table	500-0080

PLYWOOD TABLES

Plywood Cocktail Tables

- Tabletops are made to the same standards as our folding tables.
- Change heights by switching posts.
- Easily knocks down for storage; ask us about storage carts.

ITEM	SKU#
30" Round Table Top	508-0693
36" Round Table Top	508-0694
30" Square Table Top	508-0695
32" Square Table Top	508-0696
Coupler For Cocktail Table	508-0690
28" Base For Cocktail Table	508-0660
36" Round Table Top	508-0694
22" Cocktail Table Post	508-0685
30" Cocktail Table Post	508-0680
42" Cocktail Table Post	508-0670



Farm Style Table/Benches



ITEM	SKU#
40" x 96" Farm Table Straight Leg	500-0138
40" x 96" Farm Table Cross Leg	500-0138E
60" Round Planked Farm Table	500-0144R
12" x 94" Vineyard Farm Bench	500-0144

Our redesigned 8' Farm Tables now feature folding legs to facilitate easy moving and storage. All of our new tables and benches now come in a rustic vineyard finish; the perfect compliment to our vineyard crossback chairs. Constructed from solid elm.



Dakota Folding Picnic Table

509-0532

Quick and easy to set up with an improved folding system. The seat and tabletop feature a faux woodgrain embossing. A pluggable centre-hole allows for the addition of an umbrella.



ZOWN PLASTIC TABLES

Introducing

ZOWN the new **zown classic** collection
CONTRACTDESIGNFACTORY

Following ten years of proven success on the international market, ZOWN has renewed its entire CLASSIC collection. The modernised range of products has been renamed the **NEW ZOWN CLASSIC COLLECTION**.

The **NEW ZOWN CLASSIC COLLECTION** features aesthetic, technical and ergonomic improvements and is manufactured in a new shark grey colour that replaces the traditional light grey shade.

All the tables are equipped with a new and very smooth locking mechanism and the foot pads are inserted into the inner perimeter of the legs. The rectangular tables in particular have better ergonomics at the head, a lengthwise and crosswise joining system and an improved load capacity.

100% PURE HDPE. NOT MIXED

QUALITY
Zown solely uses 100% pure (first generation) high-density polyethylene, which is not mixed with recycled plastic polymers..

SHARK GREY

SHARK GREY
Table top and structure shark grey colour. Back, seat and structure of the chair shark grey.

CERTIFICATIONS

Zown products comply with BIFMA standards.

INDEPENDENT CLIP

Individual polypropylene clip to hold the leg in position when folded. Solid and durable fastening device.

CONNECTORS

Longwise and widthwise table connectors.

HIGH DENSITY

High density of vaults in the lower surface of the table top. Resistant and non-warping.

ERGONOMIC

Comfortable for those seated at the end of the table.

INTEGRATED PADS

Integrated foot pads.

ITEM	SKU#
XL120 (30" x 48") New Classic	509-0015
XL180 (30" x 72") New Classic	509-0051
XL240 (30" x 96") New Classic	509-0061
Planet120 (48" Round) New Classic	509-0161
Planet150 (60" Round) New Classic	509-0171
Planet180 (71" Round) New Classic	509-0195

*This warranty covers the original purchaser against defects in material or workmanship. Defects are defined as imperfections that may impair the proper use of the product. Defects arising from misuse, abuse or negligence will render this warranty null and void. It does not cover damages beyond the control of the manufacturer.

ZOWN SPECIFICATIONS

XL240

new zown classic
509-0061



SHARK
GREY



8



453 kg
1000 lb



18.50 kg
40.80 lb



Limited 10 year warranty



H74.3 cm
H29.3"



L243.8 x W76.2 cm
L8' x W30"

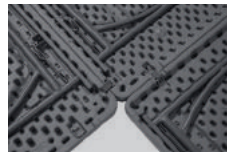

Transverse and longitudinal table joining system.



Ergonomic. Comfortable for those seated at the end of the table.



New and very smooth manual locking mechanism. Includes automatic sliding rings to prevent undesired folding.



Integrated foot pads.



XLtrolley available for 18 tables.



Capacity: 8 persons.
Area per person: 24".

Tabletop beam:
W20 x H40 x TH1.1 mm

Leg tube:
ø28.6 x TH1.0 mm

Leg axis:
ø22.2 x TH1.0 mm

Leg crossbar:
ø19.1 x TH1.0 mm





ZOWN SPECIFICATIONS



SHARK GREY

XL180

new zown classic
509-0051



6



362 kg
800 lb



NW
14 kg
30.90 lb



Limited 10 year warranty



H74.3 cm
H29.3"

L182.9 x W75.2 cm L6' x
W29.6"

48 mm

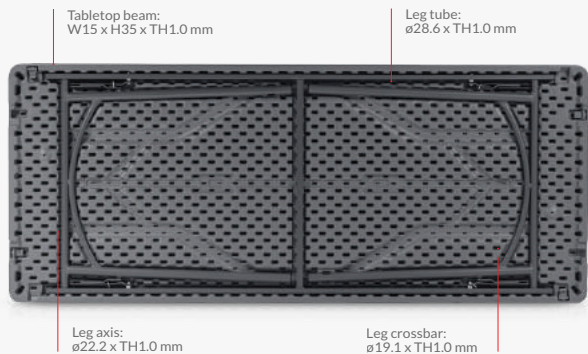

Tabletop beam:
W15 x H35 x TH1.0 mm

Leg tube:
ø28.6 x TH1.0 mm

Leg axis:
ø22.2 x TH1.0 mm

Leg crossbar:
ø19.1 x TH1.0 mm



Transverse and longitudinal table joining system.



Ergonomic. Comfortable for those seated at the end of the table.



New and very smooth manual locking mechanism. Includes automatic sliding rings to prevent undesired folding.



Integrated foot pads.



XLtrolley available for 20 tables.

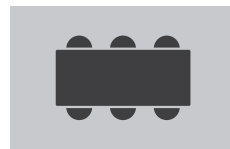

Capacity: 6 persons.
Area per person: 24".

ZOWN SPECIFICATIONS



sharptable
new zown classic

509-0271



6



13.30 kg
29.30 lb



315 kg
694 lb



Limited 10 year warranty



SHARK
GREY



Sliding ring to lock the legs in position when in use. Easy and secure.



Folding table top.



Table provided with carrying handle for ease of transport.



Capacity: 6 persons. Area per person: 24".

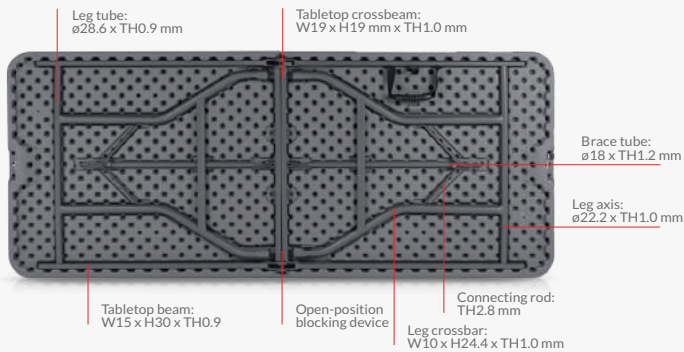



ZOWN SPECIFICATIONS



SHARK GREY

planet**150**
new zown classic
509-0051



8



340 kg
750 lb



NW
22.31 kg
49.18 lb



10 Limited 10 year warranty



Ergonomic frame design.



New and very smooth manual locking mechanism. Includes automatic sliding rings to prevent undesired folding.



Integrated foot pads.



Planetrolley available for 14 tables.



Capacity: 8 persons.
Area per person: 23.5"

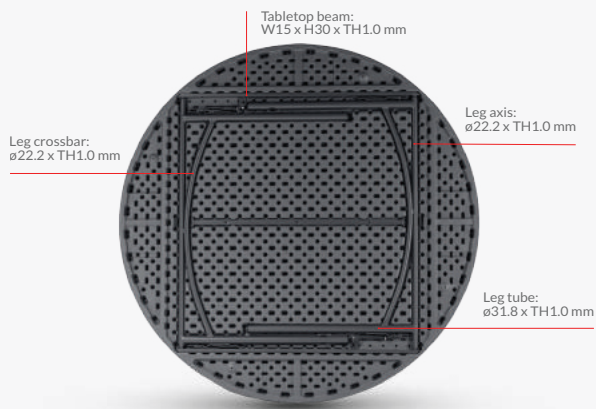

ZOWN SPECIFICATIONS



planet180

new zown classic
509-0195



10



350 kg
772 lb



29.30 kg
64.60 lb



Limited 10 year warranty



SHARK
GREY



H74.3 cm
H29.2"

ø 180.3 cm
ø 5.92'



Ergonomic frame design.



New and very smooth manual locking mechanism. Includes automatic sliding rings to prevent undesired folding.



Integrated foot pads.



Planetrolley available for 13 tables.



Capacity: 10 persons.
Area per person: 22.3".

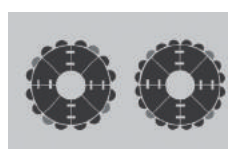

Circular joining of four XXLmoon tables with 1 planet180 table. Capacity for 12 to 20 persons.

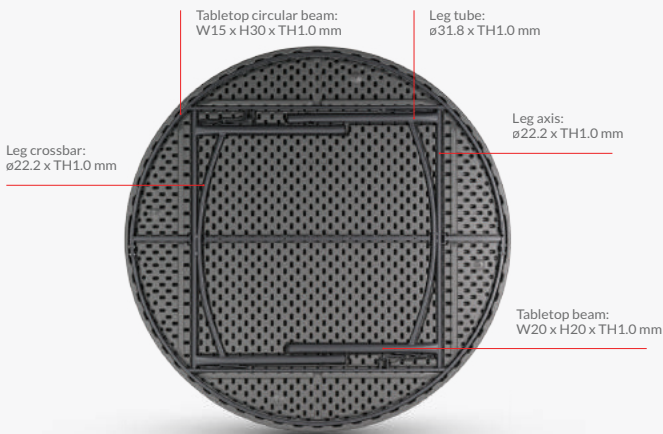



SPECIALTY ZOWN TABLES



32" Round Praxis80 Table

509-0221

Light and easy to fold and store, with a large base for stability. Café height table.

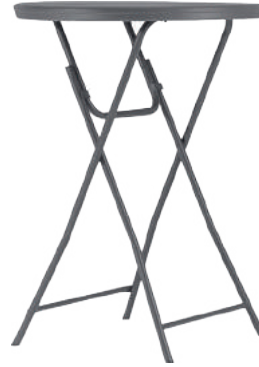

32" Round Cocktail80 Table

509-0231

A one piece folding cocktail table. Same features as our Praxis80 table but at a taller, 43" bar height.



XXL90 Table

509-0101

36"x36" folding table. The heavy duty card table.

XXL240 Table

509-0121

36"x96" folding table. Wider than the standard 30" table; ideal for events with large centrepieces or family style serving.



M183 Classroom Table

509-0256

18"x72" table popular for lecture halls, displays and tradeshow.



Worktop180 Table

509-0441

30" x 72" table with adjustable height legs.



Sharptable

509-0271

A typical 30"x72" folding table that also folds in half for transport. Includes carrying strap.

SPECIALTY ZOWN TABLES

Buffet Table Base

509-0030

72" x 30" buffet table base. Includes caster and bottom shelf. Shown with optional Topshelf 180.



Munich Table

509-0470

89" x 26" x 30" Folding table with powder-coated steel structure. High-Density Polyethylene table top, with special legs suitable for soft grounds. Green frame, brown top.



30" XL Corner Table

509-0070

This table increases the range of compositions with rectangular tables.

ITEM	SKU#
Glide (Foot) - Rectangular Plastic Table	501-0120
Glide (Foot) - Round Plastic Table	501-0130
Glide (Foot) - Coffee/Cocktail Table Base	508-0650
Glide (Foot) Steel Swivel 3/4"	590-0620
24" Wide Non Overlap Folding Leg (Pair)	508-0510
31" Wide Overlap Folding Leg (Pair)	508-0500
36" Wide Overlap Folding Leg (Pair)	508-0520
42" Wide Overlap Folding Leg (Pair)	508-0530
Leg Pair For 18" ABS Table	508-1000
Leg Pair For 30" ABS Table	508-1010
Leg Pair For 60" Round ABS Table	508-1020
Leg Pair For 72" Round Table	508-1030





STACK & RACKS



Cart/Dolly Glass Rack/ Linen
510-0160

This glass rack cart is a masterpiece of engineering. Designed by a rental company for rental companies and caterers, the cart will save you labour and time when storing, transporting and loading your racks.

XXL Table Rack
(36" Width Tables) Base

XL Table Rack
(30" Width Tables) Base

Planet 120/150 Rack
(48" / 60" Round Tables) Base

Planet 180 Rack
(72" Round Tables) Base

FOLDING CHAIRS



Aranchair

509-0351

These folding chairs feature an injected polypropylene seat and back which gently flex to provide a more ergonomic folding chair for longer events. The seat and back's mesh design allows for superior water drainage for outdoor events.

Resin/Wood Folding Chairs

Resin and wood folding chairs are popular with all kinds of events. Our resin folding chairs are crafted from the finest virgin plastic and designed to look the same as traditional wood folding chairs. Our wood folding chairs are constructed from Locust wood which makes them extremely durable. Folding is a snap and both styles will stack up to 25 high.

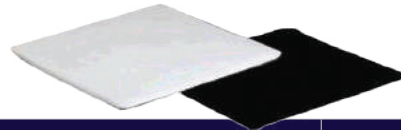

	COLOUR	SKU#
1.	White Resin/White Pad	502-1020
2.	Black Resin/Black Pad	502-1030
3.	Mahogany Resin/White Pad	502-1040
4.	Walnut Wood/White Pad	503-3000
5.	Walnut Wood/Tan Pad	502-3001
	White Seat Pad for Resin	502-1025
	Black Seat Pad	502-1035
	Ivory Resin Pad	502-1041
	White Seat Pad for Walnut Wood	502-1022
	Tan Seat Pad for Walnut Wood	502-1023



FOLDING CHAIRS



NOT ALL FOLDING CHAIRS ARE CREATED EQUAL!

The SES folding chair is as close to the original Samsonite as you will find. Don't be fooled by cheaper knock-offs!

Annealed steel tubing makes our chairs lighter and stronger than the competitor's.

Why Buy SES Folding Chairs?

FOLDING CHAIR FEATURES	GENERIC	SES
Folding & Stackable	✓	✓
Powder Coated Frame	✓	✓
Annealed Steel Tubing	✗	✓
Virgin Polypropylene	✗	✓
6lbs Light Weight	✗	✓
5 year Warranty	✗	✓
Long Term Value/Cost Comparison	✗	✓

FOLDING CHAIRS

Standard Folding Chairs

Our 2250 series chair is the best in the industry. Made of special annealed steel tubing to our exacting standards, this chair is incredibly strong and at the same time lightweight. In fact, it only weighs 6lbs.

	SEAT/ FRAME	SKU#
1.	Black/Black	502-0100
2.	Burgundy/Grey	502-0140
3.	Charcoal Grey/Grey	502-0150
4.	Chocolate Brown/Neutral	502-0170
6.	Medium Blue/Grey	502-0120
7.	Medium Grey/Grey	502-0190
8.	Neutral/Neutral	502-0200
9.	Red/Grey	502-0210
10.	Slate Blue/Grey	502-0220
11.	Teal/Grey	502-0230
12.	Off White/Off White	502-0280
13.	Snow White/Snow White	502-0260



Fan Back Chairs

Our 2000 Series of folding chairs are made of the same great quality as the 2250 series but with an appealing fan back design.

	COLOUR	SKU#
1.	Snow White	502-0270
2.	Off White	502-0275
3.	Black	502-0110

CONTAINER LOADS

BUY BIG, SAVE **BIG!**

Our direct container program is the best way to get more for your money. By shipping direct from our factories we save on freight and labour; savings that are passed on to you! We cover all customs and duties so the price we quote is the price you pay. No surprises!

18m x 40m Clearspan to NV

Saved 42%



1000 Banquet chairs to BC

Saved 41%

700 Crossback chairs to ON

Saved 33%

2,000 Chiavari chairs to AB

Saved 38%





CHIAVARI CHAIRS



Resin Chiavari Chairs

Our resin chiavari chairs are designed specifically for the demanding event industry. Utilizing a single piece monobloc design, these chairs will never loosen and offer unparalleled strength.

COLOUR	SKU#
Black	503-0700
Gold	503-0720
Mahogany	503-0740
Silver	503-0730
White	503-0710

Refer to page 41 for pads and cushions

CLEAR CHAIRS



Crystal Clear Ghost Chair

503-0320



Crystal Clear Chiavari Chair

503-1000



Crystal Clear Ghost Chair with Arms

503-0310



Sofia Crystal Clear Wide Seat Ghost Chair

503-0330



Illusion Crystal Clear Folding Chair

503-1020

All of our clear chairs feature polycarbonate construction for high impact resistance.

STOOLS



Alvarstool
509-0431



Scoop Stool
Black/White
509-0232/509-0233



Stacking Stool
590-0441

BANQUET CHAIRS



Steel Banquet Chairs
Oval Back

Constructed with a welded steel frame that is powder coated. The seat fabric is both durable and attractive and is mounted to the frame via a plywood base. It will easily stack 12 high and the chairs nest together as a solid block.

COLOUR	SKU#
Black	502-0888
Black Vinyl	502-0905
Navy	502-0900
Grey	502-0890



Waterfall Banquet Chair
502-0940

This chair has a high end look for the upscale wedding or banquet facility. The seat features a unique waterfall design for comfort and elegance. Easily stack 12 high.



Truman Chair
509-0350

This chair is designed to withstand the rigors of daily industrial use. It is constructed with a welded steel frame that is powder coated. Made from 100% injection molded polypropylene, ensuring durability and easy sanitation. Easily stack 17 high.



Bryggen Sled Base Plastic Chair
502-0910B



BANQUET CHAIRS

Banquet Tyrone Chairs

Designed to last for generations, Tyrone chairs are constructed with a welded aluminum frame that is powder coated. The seat fabric is both durable and attractive which is mounted to the frame via a plywood base. Easily stack 16 high. Chairs feature built in ganging mechanism.

	COLOUR	SKU#
1.	Diamond Pewter	503-2050
2.	Gold/Bronze	503-2070
3.	Grey/Silver	503-2080

	COLOUR	SKU#
4.	Navy/Gold	503-2060
5.	Black Obsidian	503-2045



1



2



3



4



5



Banquet Trivento Chair

502-0887

This chair is especially designed for large convention facilities where an upscale look is required. Made from a steel frame, these chairs are built to withstand the rigors of demanding convention and banquet facility use. With an injection moulded polyurethane seat, these chairs are the epitome of comfort.

RESIN LOUIS XVI CHAIRS



	COLOUR	KEY#
1.	Black/Black	503-2500
2.	Gold/Ivory	503-2510
3.	Silver/Taupe	503-2520

Resin Louis XVI Chairs

Louis XVI chairs, the new classic, are now available in resin. All the look without the issues of wood. These chairs are made using a monobloc design, no joints to get loose. Featuring interchangeable seats these chairs stack 10 high. These chairs will withstand the rigors of the rental industry being nearly chip and dent proof, featuring colour matched base plastic under a beautiful finish.

Features:

- Stack 10 high
- Interchangeable seat
- Lightweight
- Strong monoblock design





CHAIR PARTS

Folding Chair Parts



ITEM	SKU#
Chair Ganging Clip	595-0090
Black Replacement Feet (100)	502-0520
Grey Replacement Feet (100)	502-0500
Neutral Replacement Feet (100)	502-0530
White Replacement Feet (100)	502-0510
Replacement Foot for Black Comfort Series	502-0525
Replacement Foot for Neutral Comfort Series	502-0535
Glide For Banquet Stacking Chair	502-0885
Replacement Glide For Wooden Chiavari	502-0490
Saddle Plug Black Comfort Series Chair	502-0540
Saddle Plug Neutral Comfort Series Chair	502-0545

Chair Pads and Covers



ITEM	SKU#
Chair Cushion Soft Black	503-0501
Chair Cushion Soft Ivory	503-0500
Chair Cushion Soft White	503-0502
Chair Cushion For Crossback	503-0505
Chair Pad Ivory Vinyl With Plywood	503-0530
Chair Pad White Vinyl With Plywood	503-0531
Chair Dust Cover Black Chiavari	503-0520
Chair Dust Cover Black Vineyard	503-0521
Chair Dust Cover Black Phoenix	503-0522

Chair Bonnets



ITEM	SKU#
Chair Bonnet Black Signature	508-0332
Chair Bonnet Black Velvet	508-0333
Chair Bonnet Ivory Signature	508-0336
Chair Bonnet White Signature	508-0334
Chair Bonnet White Velvet	508-0334A

CONCIERGE PURCHASING

Looking for a large quantity of event products that you don't see in our catalogue or website? Give us a call! We can leverage our experience and expertise and source exactly what you need. Buying sight unseen from overseas is risky. Will you get what you expected? Special Event Sales visits all the factories that we purchase from, ensuring that what we ordered is what we receive.



SATISFACTION
★ ★ ★
GUARANTEED

Toll Free: 1 - 888 - 601 - 2961





BANQUET CHAIRS

BANQUET CHAIR

Steel (Round Black)



Chair	Width	17"
Chair	Depth	22"
Chair	Height	36"
Seat	Height	2"

DETAILS



comfortable



stacks 12 high



powder coated, welded steel frame





nest together as a solid block

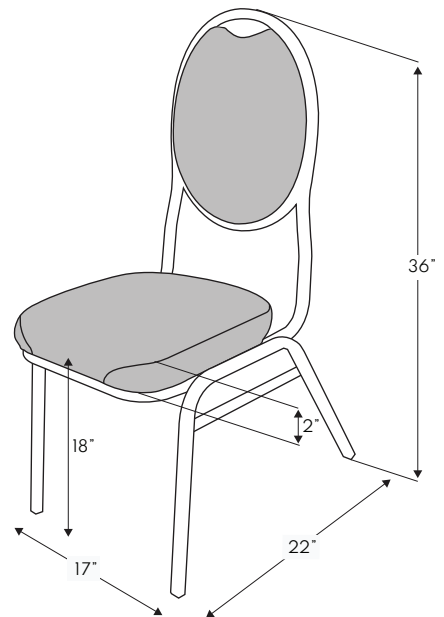

BENEFITS & FEATURES

This heavy duty chair has been tested for 15 years in our rental company. Its steel frame and durable fabric makes it last for years. Its design is perfect for storage. It's durable and comfortable at the same time.

This chair is favourite among event rental companies, banquet halls, and hotels. We have sold thousands to our satisfied clients all around Canada and USA.



AVAILABLE IN	
	Black 502-0888
	Navy 502-0900

	Grey 502-0890
	Vinyl Black 502-0905

BANQUET CHAIRS

SPECIFICATIONS

- Frame: Welded Aluminum, Powder Coated
- Fabric: Durable Commercial Grade
- 50lb Density Moulded Foam
- Stack: Maximum of 16 Chairs High
- Built in Ganging Mechanism
- Weight: 10.5 lbs
- Seat Width: 16 inches
- Seat Height: 19.5 inches
- Weight Capacity: 1100 lbs
- Warranty: 1 year



TYRONE BANQUET CHAIR

Aluminum Chairs – Durable and Light

These chairs are the workhorse of the event industry that are designed to last for generations. They are favoured by event rental companies, banquet halls, churches, and hotels. Light, durable, elegant and easy to handle.

Tyrone chairs are constructed with a welded aluminum frame that is powder coated. The seat fabric is both durable and attractive and is mounted to the frame via a plywood base.



Stack of
16 chairs
height

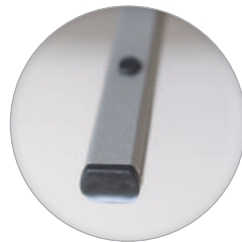

Uses rubber feet instead of the traditional swivelling glides to protect your floor from scratches. Rubber bumpers also protect the chairs from damages when stacked.

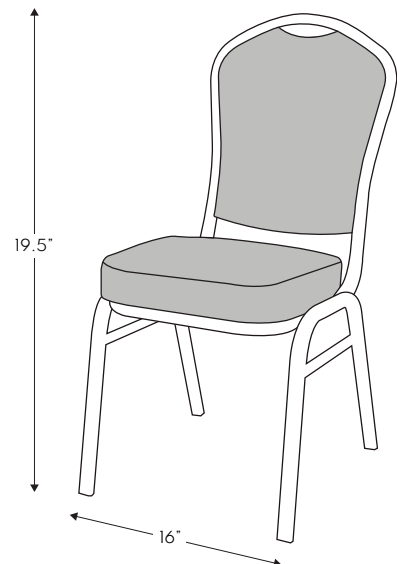



ZOWN BENCH



12" x 69" Oktober Bench

509-0290

Featuring a single top piece with folding legs and a sliding ring to lock the legs in place securely.



Base frame suitable for soft ground.



12" x 87" Munich Bench

509-0480

This bench compliments the Munich Table and features a manual lock with sliding ring and a base frame suitable for soft ground.

*Matching table available.

CHAIR CARTS

Mongo Mover/Accessories

ITEM	SKU#
Mongo Mover 2 Axle c/w 4 Foam Tires	510-0200
Chair-Pal Pallet Standard	510-0220
Chair-Pal Pallet Long	510-0230
ChairStack Cover	510-0240
33" Replacent Fork For Mongo Mover	510-0260
Wheel Guard Kit For Mongo Mover	510-0210



CHAIR CARTS



Hanging Boston Cart
509-0510

Special trolley for transporting and storing folding chairs.



OttoCart
509-0340
capacity 25

Special trolley for transporting and storing the Otto chair. Featuring easy locking and unlocking of the vertical posts. Ease of access for loading and unloading.



LiamTrolley
509-0515



Banquet Chair Square Dolly
510-0120

Special dolly for transporting and storing banquet chairs.

Long Cart
509-0500

Upright stacking trolley for folding chairs.

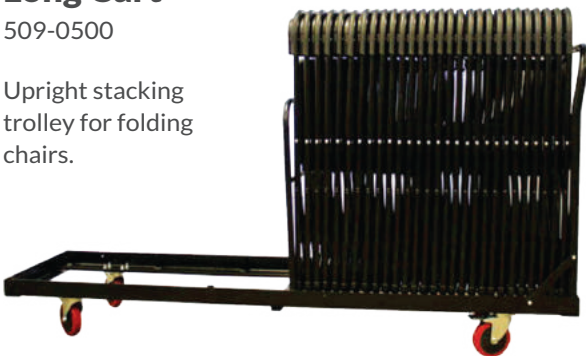

Roll/Under Banquet Chair Dolly
503-1990



Folding Chair Dolly
508-0640
capacity 50

This is the dolly of choice for storing and moving around 2250 series folding chairs. Featuring a welded steel frame that is powder coated for long term durability.



ZOWN TABLE CARTS

Planet Cart

509-0200

capacity 15

Special trolley for storing and transporting Planet Tables. Featuring extendable handle with three positions.



Cocktail Cart

509-0240

capacity 20

Special trolley for storing and transporting Cocktail80 and Praxis80 tables. Featuring a locking bar which moves along the side rails to secure the tables in position even at half load.

XL Cart

509-0090

30" Tables

Trolley for storing and transporting your Zown XL tables. This trolley is compatible with 60", 72", and 96" tables. Each cart has a capacity of 20 tables. 76" X 30.3" X 45.3" High



CARTS & TROLLEYS

Alexandra Cart

509-0520

The Alexandra trolley is designed to store and transport fan-back folding chairs up to 75 chairs high. 37.5" X 18.7" X 77.5" High



Display Rack

509-0450

The Zown display rack is a great way to display your rental tables. 5 table slots allow you the opportunity to safely and neatly show your different size options to customers. 25.2" X 24" X 28" High



Deluxe Cocktail Table Cart

For 30" Tables
510-0140

For 36" Tables
510-0150



Universal Multitrolley

509-0205

The Multitrolley is designed to store and move both rectangular and round tables. Extends to allow a secure fit regardless of table length.





HAND TRUCK



Heavy Duty Liberator Aluminum Hand Truck

510-0090

Features a loop handle, straight back frame, 18" wide x 9" deep extruded aluminum nose plate, 10" flatproof airless tires, 60" frame extension to provide 60" overall hand truck height, extruded aluminum stair climbers with heavy duty wear strips and 600lb. capacity.



Chair Mover Hand Truck

590-0420

Traditional banquet hall dolly. Stronger than what is found in big box stores. This dolly features a folding arm for moving banquet chairs.

CARPET

Carpets

Our carpets are great for high end functions and feature vibrant colours. The edges are bound with matching thread so you don't have to worry about fraying or unravelling. Make your guests feel special by rolling out one of our carpets for them.



ITEM	SKU#
4' x 10' Black Carpet	515-0003
4' x 25' Black Carpet	515-0010
6' x 25' Black Carpet	515-0060
12' x 12' Black Carpet	515-0082
4' x 10' Red Plush Carpet	515-0006
4' x 25' Red Plush Carpet	515-0041
6' x 25' Red Plush Carpet	515-0046
12' x 12' Red Carpet	515-0085
4' x 10' Snow White Plush Carpet	515-0008
4' x 25' Snow White Plush Carpet	515-0043
6' x 25' Snow White Plush Carpet	515-0048
12' x 12' White Carpet	515-0087

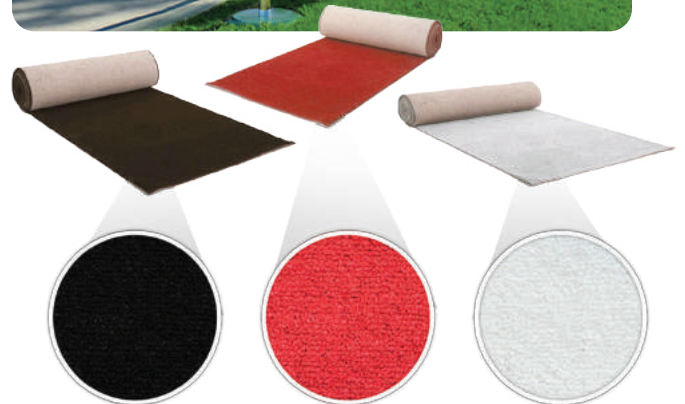

DANCE FLOORING



Dance Floor

These popular dance floors are engineered for indoor or outdoor use and are 100% waterproof. Featuring the "No Walk" technology you will be sure that these dance floors stay in place.

	ITEM	SKU#
1.	Luxury Black - 12" x 12"	520-3030
2.	Luxury White - 12" x 12"	520-3040
3.	Oak - 12" x 12"	520-3050
4.	Slate Black - 12" x 12"	520-3055
5.	Slate White - 12" x 12"	520-3057
6.	Teak - 12" x 12"	520-3060
7.	XL Maple - 18" x 18"	520-2990
8.	XL Smoked Oak - 18" x 18"	520-2280
9.	Smoked Oak - 36" x 36"	520-2999
10.	Dark Maple - 36" x 36"	520-2998
	Ebony - 36" x 36"	520-2993
	Ivory - 36" x 36"	520-2994

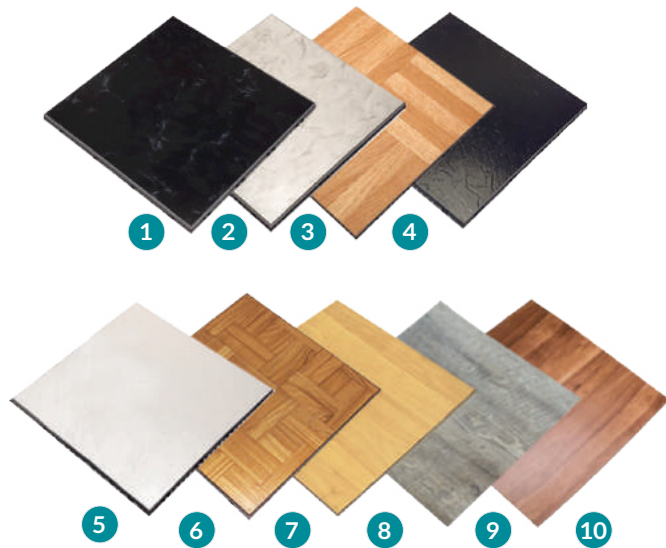

Snaplock Dance Floor Cart

520-1020

24" x 48"

Capacity of 400 tiles

Dance floor carts are an easy and convenient way to store and transport your dance floor. The handle and corner posts are removable for easy access.





UTILITY FLOORING

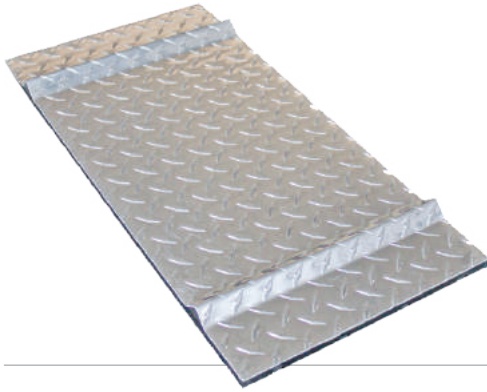

Accupark

520-8100

520-8110

1' x 2'

The Accupark system seamlessly integrates into your RaceDeck floor, guiding you to the precise spot in your garage where you need to park every time.

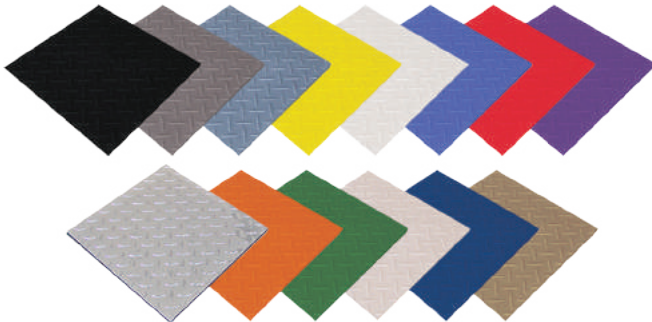

RaceDeck Diamond/Circle Track

12" x 12"

12" x 12" Tuffshield

18" x 18"

12" x 12" Pro Polished Aluminum

The original diamond tread garage flooring system. Offering slip resistance and easy clean surface that is resistant to petroleum products.



COLOUR	SKU#
Alloy	520-4000
Black	520-4020
Graphite	520-4050
Orange	520-4070
Purple	520-4080
Red	520-4090
Royal Blue	520-4100
White	520-4110
Yellow	520-4120
Pro Polished Aluminum	520-4075
Beige	520-4010
XL Alloy	520-4495
XL Black	520-4500
XL Graphite	520-4497
XL Orange	520-4505
XL Red	520-4510
XL Royal Blue	520-4515
XL White	520-4520
XL Yellow	520-4530
Tuffshield, Alloy	520-6520
Tuffshield, Beige	520-6480
Tuffshield, Black	520-6500
Tuffshield, Espresso	520-6490
Tuffshield, Graphite	520-6530
Tuffshield, Orange	520-6580
Tuffshield, Purple	520-6560
Tuffshield, Red	520-6540
Tuffshield, Royal Blue	520-6570
Tuffshield, White	520-6510
Tuffshield, Yellow	520-6550

UTILITY FLOORING



FreeFlow

12" x 12" x .5"

Free-Flow garage tiles offer maximum airflow and drainage of liquids and debris. Increases safety in wet conditions – liquid goes through the floor and out the door.



COLOUR	SKU#
Alloy	520-6000
Beige	520-6010
Black	520-6070
Graphite	520-6080
Orange	520-6020
Purple	520-6030
Red	520-6040
Royal Blue	520-6050
White	520-6075
Yellow	520-6060

DuraGrid

12" x 12" x .5"

Perfect for locker rooms and showers. DuraGrid® is manufactured with anti-bacterial and anti-fungal agents to ensure a clean and healthy surface environment. Featuring interlocking floor tiles that simply 'snap' together to create virtually any size free draining, slip resistant surface. No tools needed!

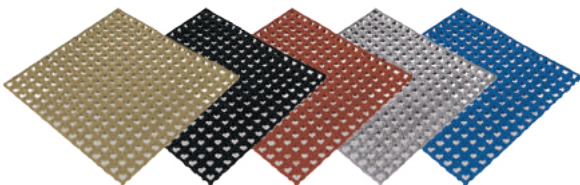

COLOUR	SKU#
Beige, Comfort	520-8035
Black, Comfort	520-8037
Brick Red, Comfort	520-8046
Grey, Comfort	520-8040
Royal Blue, Comfort	520-8045
Beige, Non-Slip	520-8070
Black, Non-Slip	520-8080
Brick Red, Non-Slip	520-8085
Grey, Non-Slip	520-8060
Royal Blue, Non-Slip	520-8050



UTILITY FLOORING



4' x 8' Alloy Harley Davidson Kit

520-8130



4' x 8' Black & Orange Harley Davidson Kit

520-8120

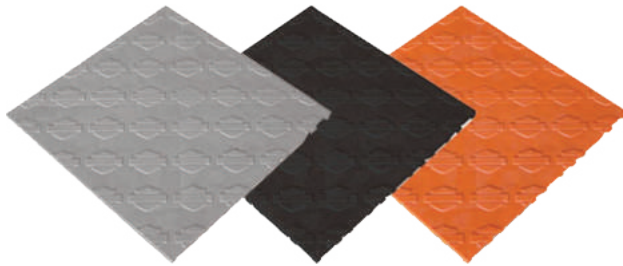

Harley Davidson

12" x 12" x .5"

Harley Davidson Tuffshield

Harley-Davidson's recognizable cross bar and shield design adorns this RaceDeck garage flooring. Also available in kits and Tuffshield.

COLOUR	SKU#
Black	520-6584
Alloy	520-6582
Orange	520-6586

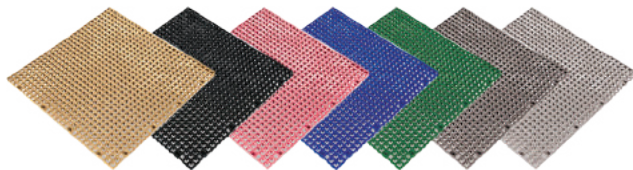

Deck Tile

12" x 12" x .5"

Great solution for home patios and decks. Covers up concrete patios offering a cosmetically appealing 'cushioned' surface and eliminates water problem areas.

COLOUR	SKU#
Beige	520-8012
Brick Red	520-8013
Evergreen	520-8014
Grey	520-8010

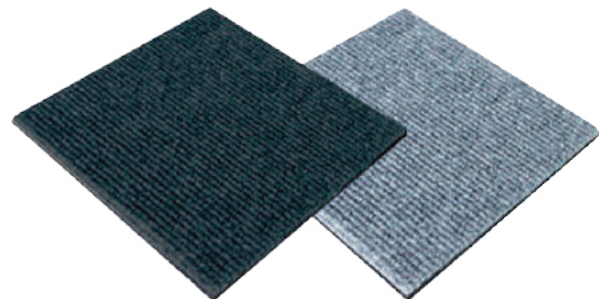

Snap Carpet

12" x 12" x .5"

The Authentic and Original solid carpeted surface that simply "snaps" together. Engineered to handle extreme roll loads.

COLOUR	SKU#
Black	520-6990
Charcoal	520-7010

UTILITY FLOORING



Tile Unzipper

520-9910

Use this handy tile unzipper for taking apart your FastDeck 1.0 floor. Can also be used to take apart DanceFloor. This will save your back and make floor disassembly a breeze.



Fastdeck 2.0 Natural

520-2005

12" x 24"

FastDeck 2.0 is used in the same applications as FastDeck while causing less damage to grass. Translucent plastic allows sunlight to reach the grass allowing for longer use.

EDGE TRIM

Edge Trim

Give your floor a finished look with a beveled edge. With the same interlocking system this trim just snaps into place on all Snaplock flooring products.

*Available in multiple colours.

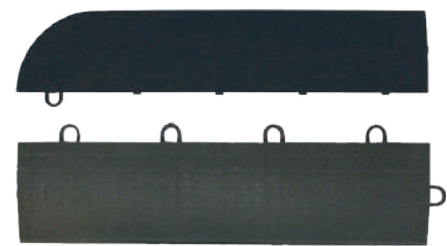

ITEM	SKU#
3" x 12" Female Edge w/Corner	520-0010
3" x 12" Male Edge w/Corner	520-0020

ITEM	SKU#
3" x 12" Female Edge	520-0030
3" x 12" Male Edge	520-0040

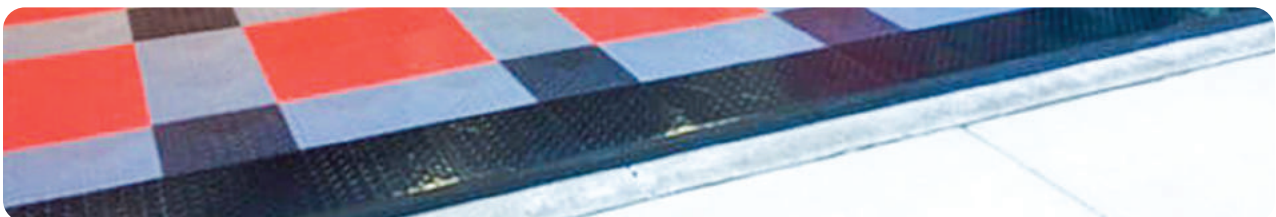

PIPE AND DRAPE

New Supplier, Same Quality, New **LOW PRICES!**

Special Event Sales is proud to announce new low prices for pipe and drape. After years of development we have secured new suppliers for pipe and drape. The quality of the product meets or exceeds what we previously offered and due to reductions in cost we are able to pass the savings on to you! All Special Event Sales drape panels are inherently flame retardant and meet CAN/ULC-S109-3 standards.

Banjo Drape

Banjo is the industry standard. You will find this drape nearly everywhere including conventions centres, malls, community centres, schools, and anywhere else where an affordable dividing wall is required. Standard Banjo drape panels are 4' wide. One panel for every two linear feet of drape is recommended for proper fullness. Stocked in black and blue, other colours available through special order.

ITEM	KEY#
12' Banjo Black	540-0125
8' Banjo Black	540-0120
3' Banjo Black	540-0122
12' Banjo Blue	540-0270
8' Banjo Blue	540-0275
3' Banjo Blue	540-0280
12' Banjo Special Order	N/A
8' Banjo Special Order	N/A
3' Banjo Special Order	N/A

Pipe and Drape



Premier Drape

Premier drape provides an upscale look at a reasonable price. It is composed of a knit fabric with a linen look. Premier drape has a 60" panel width, 1 panel is recommended for every 2.5 linear feet. Stocked in black and white with other colours available via special order.



ITEM	KEY#
16' Premier Black	540-0127
12' Premier Black	540-0124
8' Premier Black	540-0118
3' Premier Black	540-0123
16' Premier White	540-0128
12' Premier White	540-0108
8' Premier White	540-0109

PIPE AND DRAPE



Blackout Drape

540-0231
12'

540-0241
8'

Blackout Drape features a weave that blocks sun and other light sources. An excellent solution for fashion show change rooms, room darkening, or any other application that requires privacy.

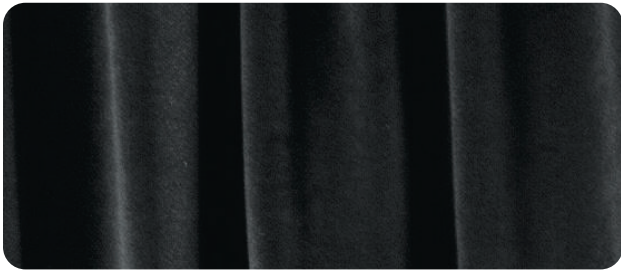

Velour Drape

540-0129
16'

540-0126
12'

540-0117
8'

Velour Drape provides a lush, luxurious backdrop for your event. Commonly used for a staging backdrop.

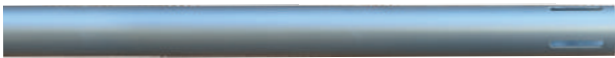

Fixed Uprights

Fixed uprights are the quickest and most economical solution to pipe and drape. Our fixed uprights are 1.5" in diameter. Simply drop the upright on the pin and hook in your drape support.

ITEM	SKU#
3' Tall Aluminum 1.5"	540-0030
8' Tall Aluminum 1.5"	540-0020
4' Extension 1.5"	540-0040
3' Tall Aluminum 2"	540-0031
8' Tall Aluminum 2"	540-0021



Adjustable Uprights

Adjustable uprights are favoured for smaller scale setups due to their versatility. The height is easily adjustable allowing for custom heights or simply to make putting up 12' drape easier. Heights are conveniently marked by laser etching. Our adjustable uprights require a 2" pin.

ITEM	SKU#
6' - 10' Adjustable Aluminum 2"	540-0015
7' - 12' Adjustable Aluminum 2"	540-0013
7' - 12' Adjustable Black 2"	540-0014
9' - 16' Adjustable Aluminum 2"	540-0018
9' - 16' Adjustable Black 2"	540-0016
7' - 17' Adjustable Aluminum 2"	540-0019



PIPE AND DRAPE



Drape Supports

Special Event Sales' drape supports are adjustable allowing for the perfect width. Our supports feature single piece cast steel ends ensuring long service life. The button stop keeps your support the length you set it.

ITEM	SKU#
4' - 7' Slider	540-0060
3' - 5' Slider	560-0065
6' - 10' Slider	540-0050
7' - 12' Slider	540-0052
8' - 14' Slider	540-0054

Baseplates

These baseplates are thicker than the competitions standard model, creating a more stable base. 18" x 18" baseplates are recommended for 12' high drape and high traffic areas. Pins sold separately. Rounded corners reduce the risk of injury or damage.

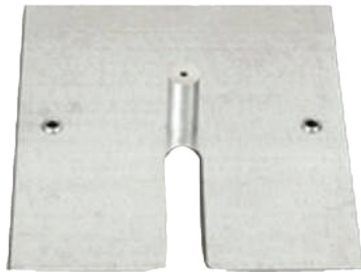

540-0005 (Silver)
14" x 16"

540-0011 (Black)
18" x 18"



Base Weight

540-0012
18" x 18" x 2"

Available in 20 lbs.



Crossbar Hanger

540-0070 540-0080
3" 9"

Double tier your drape without additional uprights and baseplates.



Baseplate Pin

540-0006 540-0007
1.5" 2" x 3"

540-0008
2" x 6"

Storage

Store your pipe and drape when not in use using a combination of storage bags and totes.

ITEM	SKU#
Flip Top Tote	590-0040
Baseplate Carrying Bag	540-0480
Pipe Carrying Bag 6'	540-0450
Pipe Carrying Bag 8'	540-0460
Pipe Carrying Bag 10'	540-0470

LINENS



Tablecloths & Napkins

These are not the lightweight see-through linens that you will find elsewhere. They will endure all kinds of abuse and still come out of the washer looking like new. They feature 100% polyester fabric that is of a heavy weight. Edges are merrrow stitched to give a long lasting professional finish. Stain resistant fabric that launders easily. Colours remain bright and vibrant, even after 100's of washes. Readily available in black, white and ivory. Inherently flame retardant to satisfy fire code.

SIZES AVAILABLE			
545-2180	90" x 156"	545-2150	90" x 132"
545-2030	84" x 84"	545-2120	60" x 120"
545-2000	54" x 54"	545-2300	132" Round
545-2270	120" Round	545-2270	108" Round
545-2210	90" Round		

SPANDEX COVERS



42" x 30" Spandex Covers

Our spandex covers have been specifically designed to fit over our cocktail tables. These heavyweight and long-lasting covers feature reinforced pockets at the base where the table feet contact the ground. Machine washable and available in a variety of colours.

AVAILABLE TO ORDER	
White	Copper
Navy	Black
Red	Green
Turquoise	Pink
Gold	

ZOWN FABRIC COVERS



Spandex Cover



Basic Cover

ITEM	SKU#
30" Black Cocktail Stretch Topper	509-1120
30" Red Cocktail Stretch Topper	509-1160
30" White Cocktail Stretch Topper	509-1180
30"x 72" XL 180 Black Stretch Cover	509-1080
30"x 72" XL 180 White Stretch Cover	509-1090
30"x 96" XL 240 Black Stretch Cover	509-1100
30"x 96" XL 240 White Stretch Cover	509-1110
Cocktail 80 Black Stretch Cover	509-1060
Cocktail 80 White Stretch Cover	509-1070





CHAIR COVERS



Chair Covers Black/White

545-3010 / 545-3000

Chair covers are an excellent way to add elegance to your event. Spandex material allows our swag covers to fit most banquet chairs.

TABLE SKIRTS



14' Premier Table Skirt Black/White

546-0500 / 546-0510

Our premier tableskirts are made of top quality materials. When only the best will do, this is the tableskirt you want. It comes with velcro on the top band to easily attach the tableskirt to the table. We also sell velcro clips to easily attach tableskirt to a variety of tables.



Banjo Table Skirt

Black Special Order

Our 14' long banjo table skirts are the workhorse of the industry. These are made from durable banjo flame retardant fabric. Velcro is conveniently sewn into the top band of table skirt making attachment to tables easy.

AVAILABLE TO ORDER	
French Blue	Berry
Navy	Red
Gold	Green
Beige	Hunter
Peach	Plum
Orange	Violet
Brown	Seafoam
Silver	Charcoal

TABLE ACCESSORIES

Table Clips

Our Velcro table clips are a great way to secure your table skirting in place. Simply clip to your table and attach your table skirt to the Velcro.

ITEM	SKU#
5/8" - 1" for 3/4" plywood tables	595-0100
1.5" - 2.25" for standard plastic tables	595-0110
Skirt Hanger	546-0600

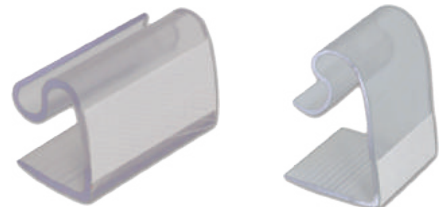

LED FURNITURE & ACCESSORIES

LED Bars & Furniture

All of our LED bars and furniture are made of virgin polyethylene which makes them incredibly durable and perfect for the rental industry. Integrated LED lighting creates 7 modes in 16 colours and are recessed into the bar bottom to protect the electronics.

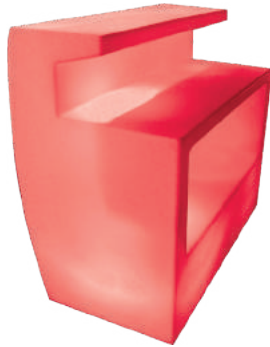

LED Rectangular Polyethylene Bar

511-0015

Dimensions: 32" x 32" x 43"

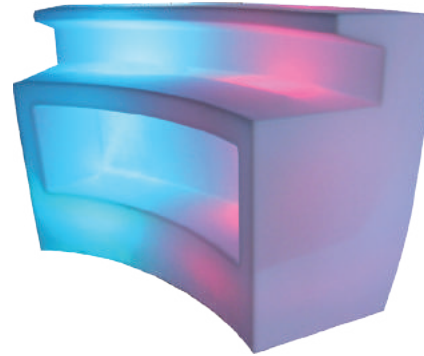

LED Curved Bar

511-0035

Dimensions: 62" x 16" x 40"



LED Round Cocktail Table

511-0090



LED Square Cocktail Table

511-0100



LED Podium

511-0250



LED Rectangular Coffee Table

511-0230



LED FURNITURE & ACCESSORIES

LED Columns



ITEM	SKU#
12" x 28"	511-0060
12" x 44"	511-0070
12" x 68"	511-0080

LED Sphere

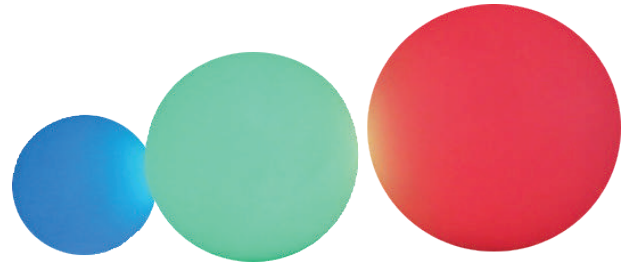

ITEM	SKU#
10"	511-0130
12"	511-0140
14"	511-0150
16"	511-0160
20"	511-0170
24"	511-0180

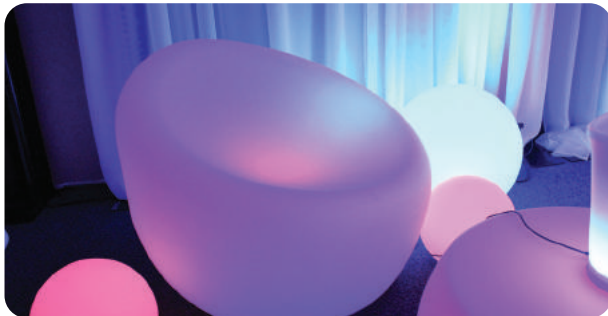

LED Sofa Chair

511-0190



LED Ice Bucket/Shelf

511-0040

Dimensions: 48" x 16" x 16"



LED Stool

511-0260

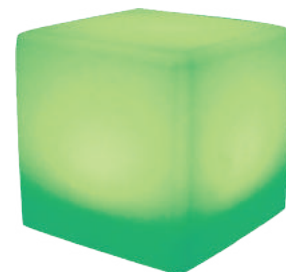

LED Cube

511-0050

LED FURNITURE & ACCESSORIES



LED Remote Control

511-0222

Replacement remote control for SES LED furniture.



LED Charger

511-0224

Replacement AC adaptor for SES LED furniture.



LED Core Unit

Replacement LED light unit for SES LED furniture. This unit can also be used to add LED to existing acrylic bars.

ITEM	SKU#
Broad Spectrum	511-0210
Projector Spectrum	511-0220

LED FURNITURE & ACCESSORIES

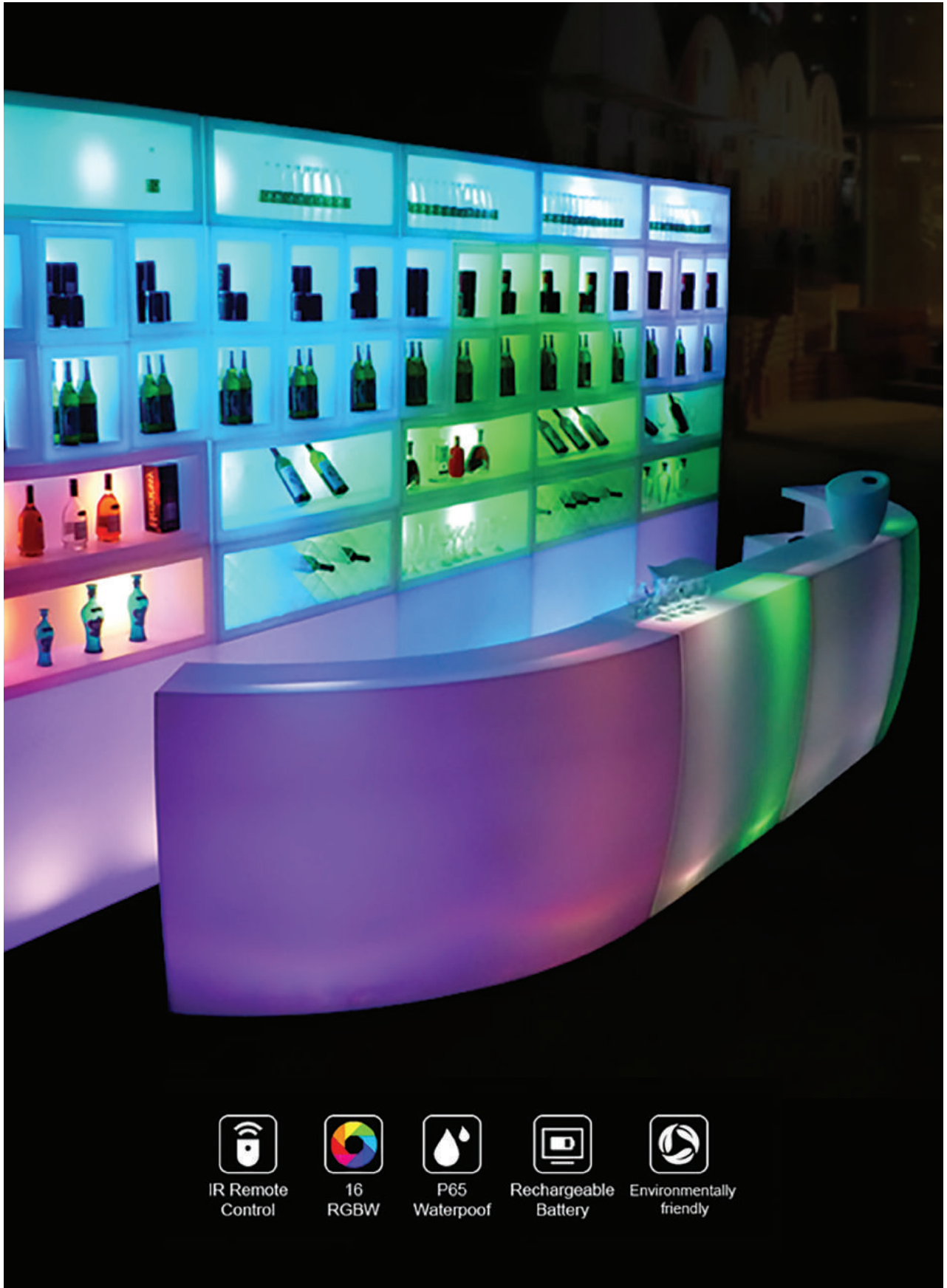

IR Remote Control



16 RGBW



P65 Waterproof



Rechargeable Battery



Environmentally friendly

LED FURNITURE & ACCESSORIES



Folding full service bar with a steel frame and PE panels. RGBW LED lights with remote included.

Complete with two ice/waste buckets and a full width speed rail to hold the bottles.



Collapses for denser storage and transportation.



**LED Folding Bar
Black Frame**
511-0300



**LED Folding Bar
White Frame**
511-0310



STANCHIONS



Traditional Stanchion

596-1030

- Use with ropes for a traditional upscale look
- 4-way attachment
- Galvanized steel weight with protective rubber base
- Superior tip resistance



Nesting Stanchion

596-1040

- Unique base design allows for dense storage
- Low profile base reduces trip hazard

Signholder T-Rope Stanchion

596-1080

- Elegant chrome finish
- Accepts letter size signs
- Includes two plastic sign protectors



Velvet Rope

- Thick classic theatre rope
- Durable steel end clips
- Available in black and red



Black
596-1010



Aluminum
596-1000

Tape Top Stanchions

- 3m tape
- 4 Way attachment
- ABS weight cover
- Concrete filled galvanized weight with rubber floor protection ring

Storage carts available

GLASS RACK

Glass Racks

Our glass racks are built to the highest standards and will help simplify the storage and washing of your beverage glasses. They feature snap fit construction which facilitates easy construction and customization of your racks.

Stacks with most competitor's racks.

Handles on all 4 sides for easy movement.

Textured surface diminishes scratches.

Snap-fit extenders will not rust or loosen like metal screws. Open profile allows air to circulate freely, resulting in faster drying.

NSF certified. Compatible with Traex racks.

See page 28 for our glass rack cart.

ITEM	SKU#
9 Compartment Base Beige	525-0005
9 Compartment Ext Beige	525-0007
16 Compartment Base Rack	525-0040
16 Compartment Extender Rack	525-0050
25 Compartment Base Rack	525-0010
25 Compartment Extender 1 Rack	525-0020
25 Compartment Extender 2 Rack	525-0030
36 Compartment Base Rack	525-0060
36 Compartment Extender 1 Rack	525-0070
36 Compartment Extender 2 Rack	525-0080
49 Compartment Base Rack	525-0085
49 Compartment Extender Beige	525-0087
Open Extender Rack	525-0090
8 Compartment Cutlery Rack	525-0003

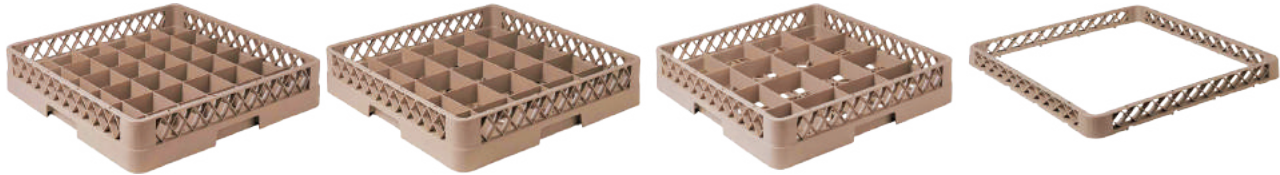

COLOUR	SKU#
Green	525-0100
Red	525-0110
Blue	525-0120
Yellow	525-0130
White	525-0180



Guide Card Rack

These handy guide cards will help you easily identify different glasses without looking in the rack. They snap in place and can be mounted on all 4 sides of rack if desired. Consider using multiple colour cards to create your own colour codes.



3 Head Brush for Glasses
525-5050



FOOD CARRIERS

Ultra Grey Food Carrier

Tough, polyethylene shell and thick foam insulation throughout the cabinet and between compartments maintain safe food temperatures for 4 hours or more.

Full swing doors open to the side of the cart for easy loading and unloading. Easy to maintain and won't dent, crack, rust or chip.



Grey Wheel Kit for Food Carrier

525-0520

Single

525-0500

Double

525-0510



Insulated Pan Holders

Top-loading food pan carriers hold, transport and serve a single full-size pan of hot or cold food. Sturdy and durable, seamless polyethylene or polypropylene with thick foam insulation.

ITEM	SKU#
Small	525-0530
Medium	525-0540
Large	525-0550

BEVERAGE SERVERS



Insulated Beverage Servers

Use to hold, transport and serve hot or cold beverages for up to 4 hours. Pre-heat or pre-chill before use to guarantee maximum operational efficiency. Drip-proof recessed spigot for easy self-serve access.

ITEM	SKU#
7L	525-1000
9.4L	525-1010
18L	525-1020
44.5L	525-1030



20L Bucket Dispenser w/ Spout

525-1050



Beer/Water Pitcher

525-0456

FOOD CARRIERS

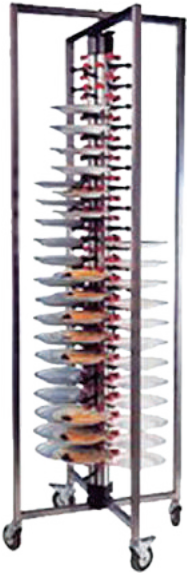

84 Capacity Plate Stacker

525-0400

Increase serving efficiency. This mobile plate stacker is stainless steel and has the capacity to hold 84 pre-plated plates. The swivel wheels make moving around in banquet halls or kitchens carefree and consist of wheel locks for added security to make sure your rack stays in place.



Plate Caddy

525-0410

CATERING SUPPLIES



Frosted Wine Bucket

525-4000

Perfect to keep your specialty and imported wines or champagne chilled until the moment you pop the cork.



Glass Holder

525-4110

Perfect for cocktail parties, this clip-on glass holder gives you a place to keep your wine.



Hospitality Cart

525-2000

This light cart is ideal for hotels, restaurant and bars. The three-tier design provides enough space for storage with a convenient open top layer.



Bottle Opener

525-4100





GOOD

Methanol

- 3 Hour burn time
- Economical
- 72 Cans per case



BETTER

Ethanol

- 3 Hour burn time
- 72 Cans per case
- Environmentally friendly
- Meets sustainability requirements where mandated



BEST

Oil Wick

- 6 Hour burn time
- 48 Cans per case
- Can be re-lit
- Cool to touch
- Adjustable wick length for variable temperature control

INFERNO FLAME: **CHAFFER DISH FUEL**

TABLEWARE

Simply White Dinnerware

This dinnerware set has a classic white design. Restaurant quality at affordable prices. These top grade porcelain pieces are dishwasher, oven, and microwave safe.



ITEM	SKU#
11.25" Dinner Plate	526-1000
8" Salad/Dessert Plate	526-1010
6" Bread/Butter Plate	526-1020

ITEM	SKU#
9" Soup Bowl	526-1030
Coffee Mug	526-1040
Coffee Cup and Saucer	526-1050

Flatware

All Special Event Sales flatware is made with ¹⁸/₈ stainless steel, including the knives. Many manufacturers use ¹⁸/₀ for the knives to reduce costs at the expense of a knife that is prone to rust and blemishes. Premium tempering ensures durability.



ITEM	SKU#
Dinner Knife	526-0010
Dinner Fork	526-0020
Salad/Dessert Fork	526-0030
Teaspoon	526-0040
Churrasco Steak Knife	526-0050

Heritage

A simple, traditional design with substantial weight.



Maria

A rental company favourite. Maria cutlery features an ornate design and restaurant quality weight.

ITEM	SKU#
Dinner Knife	526-0100
Dinner Fork	526-0110
Salad/Dessert Fork	526-0120
Tablespoon	526-0130
Teaspoon	526-0140

Soluxe

A clean, modern look with the same restaurant quality as our other lines.



ITEM	SKU#
Dinner Knife	526-0200
Dinner Fork	526-0210
Salad/Dessert Fork	526-0220
Tablespoon	526-0230
Teaspoon	526-0240





STEAKMATE

The Steakmate barbecue is optimized for reliable rental operations. They are available in three sizes and range from 62,500 to 125,000 BTU ensuring high even heat to satisfy every chef. Steakmate barbecues are easy to disassemble for cleaning and maintenance, and feature durable burners and stainless steel grates. The units are built to CSA specifications.



**RENTAL
COMPANY**
favourite



STEAKMATE

Steakmate Barbecue

This heavy duty barbecue has been designed by our engineering department to provide large cooking capacity, easy cleaning and long life. It features a powder coated steel frame with 2 rigid and 2 locking swivel casters. The firebox, drip trays and top shelf are constructed from stainless steel, ensuring long life and easy cleanup. Burner is made from heavy duty black pipe and will last for years. We have eliminated messy lava rock and have designed an industrial stainless steel flavourizer assembly to sit on top of the burner. No tools are required for disassembly, so cleanup is a breeze. CSA and UL approved design.

ITEM	KEY#
3' x 2' x 3' Steakmate Barbecue	530-0020
4.5' x 2' x 3' Steakmate Barbecue	530-0015
6' x 2' x 3' Steakmate Barbecue	530-0010



Steakmate Roll Top

This roll top is an ideal add on to your Steakmate barbecue. It will bolt securely to your barbecue and provide protection from wind. The roll top also features a handy thermometer. Built from solid stainless steel, it will last for many years.

ITEM	KEY#
3' x 2' Steakmate Roll Top	530-0040
4' x 2' Steakmate Roll Top	530-0045
6' x 2' Steakmate Roll Top	530-0050





STEAKMATE GRIDDLES



36" x 20" Steakmate Griddle

530-0060

The Steakmate griddle is a powerful cooking machine that will produce pancakes as fast as you can pour the batter! We have proven the quality of this machine for many years in our rental fleet. Hundreds have been sold across Canada to other rental companies and caterers. It features a robust steel frame with 2 rigid and 2 locking swivel casters. It has a 90,000 BTU burner that is controlled by 3 valves to precisely control temperature. CSA and UL approved design.



30" x 18" Steakmate Griddle Top

530-0030

This handy griddle top is made from solid steel and will last forever! It's the perfect add-on for your Steakmate barbecue as it instantly transforms it into a griddle. Have the best of both worlds when you add this griddle top to your barbecue!

BBQ PARTS



Grill/Grate

530-0023

Replacement grill/grate for steakmate barbecue.



Grill Drip Tray

530-0230

Replacement drip tray for steakmate griddle.



Knob

530-0210

Replacement knob for steakmate barbecue or griddle.



Flavour Tray

530-0021

Replacement stainless steel flavour tray for steakmate barbecue.



Double Burner

530-0225

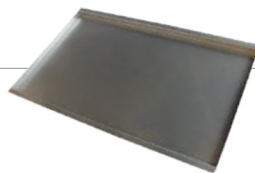

Barbecue Drip Tray

530-0022

Replacement stainless steel drip tray for steakmate barbecue.



Valve

ITEM	SKU#
Griddle Valve	530-0200
Barbecue Valve	530-0205
Legacy Valve	530-0206

ZUBRI PATIO HEATERS



Zubri Patio Heater

535-0010

The Zubri patio heater is a masterpiece of design and function. It features a high output 40,000 btu burner that is sure to keep your guests warm and comfortable, whatever your event.

It conveniently breaks down into several pieces to facilitate easy transportation and storage. The heater is supplied with a high impact abs storage case which is virtually bullet proof.



ZUBRI PARTS

ITEM	KEY#
Carry bag for Reflector	535-0110
Reflector Shield	535-0020
Gas Valve	535-0030
Leg Skirt	535-0040
Thermocouple	535-0050
Regulator & Hose	535-0060
Gas Knob	535-0070
Gas Bottle Stand	535-0080
Hanging Hook	535-0090
Leg	535-0100



Gas Knob



Reflector Shield



Gas Valve



STAGE PLATFORMS

Tuffstage

Tuffstage is a professional grade portable concert stage with all the necessary features, at a much lower price point. Tuffstage is constructed with an aluminum frame and ¾" plywood deck. The deck has a plastic non-slip laminate applied to the surface to promote safety and to improve the look. The legs feature the best foot in the industry, allowing for fine adjustment to both the height and the angle for a perfect installation. Integrated joiners ensure that the stage stays put with less parts. Compatible with steps and skirting; rails and ramps are also available to order.

ITEM	KEY#
4' x 8' Tuffstage Deck	512-1000
4' x 4' Tuffstage Deck	512-1010
8" Rigid Leg	512-1020
12" Rigid Leg	512-1030
12" - 16" Telescopic Leg	512-1060
16" - 24" Telescopic Leg	512-1070
24" - 40" Telescopic Leg	512-1080
4' x 8' Replacement Deck	512-1100
16" - 24" Stairs w/ Rail	512-1110
24" - 40" Stairs w/ Rail	512-1120
4' Guardrail	512-1130
4' Corner Guardrail	512-1135
8' Guardrail	512-1140
Guardrail Post	512-1150
Guardrail Clamp	512-1160



STAGING PLATFORMS

TUFFSTAGE STAGING

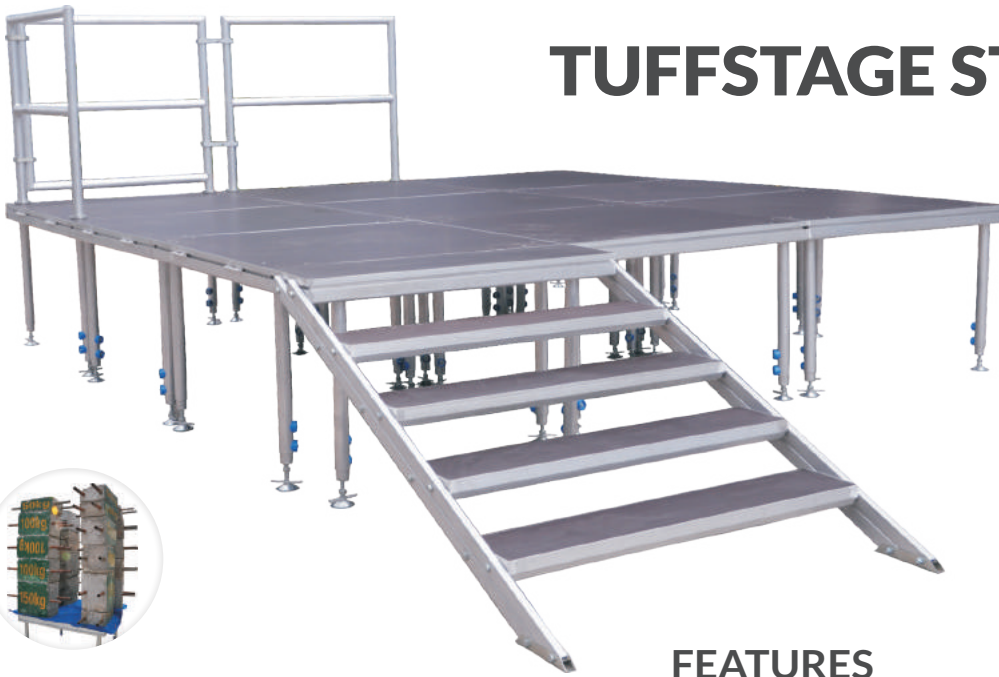

FEATURES

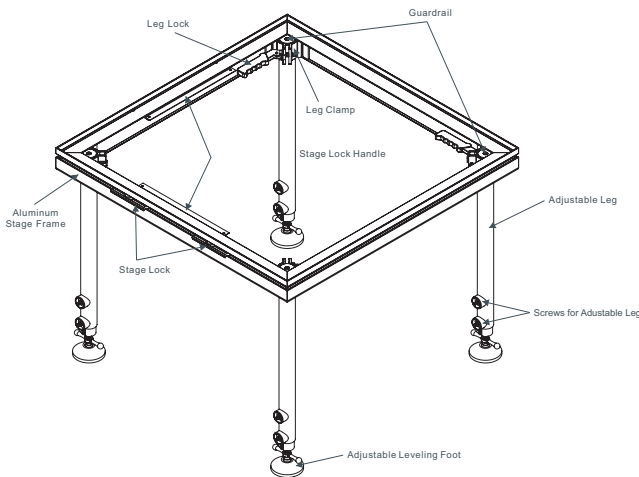

Tool-less leg lock



Integrated Stage Locks

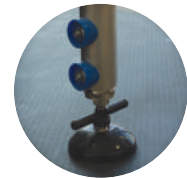

Height Adjustable Legs



Leveling Feet



Guardrails



Stairs

SPECIFICATION

Model	512-1010	512-1000
Specification ft (mm)	4' x 4' (1220*1220)	4' x 8' (1220*2440)
Loading Capacity lbs/ft ²	150	150
Weight lbs (kg)	68 (31)	107 (48.5)
Legs per Deck	4	6
Surface	Plywood w/ nonslip	Plywood w/ nonslip
Warranty	5 Year Limited	5 Year Limited



MISCELLANEOUS



24" Prize Wheel

590-0555

Fun and customizable, this prize wheel is the perfect addition to any party.

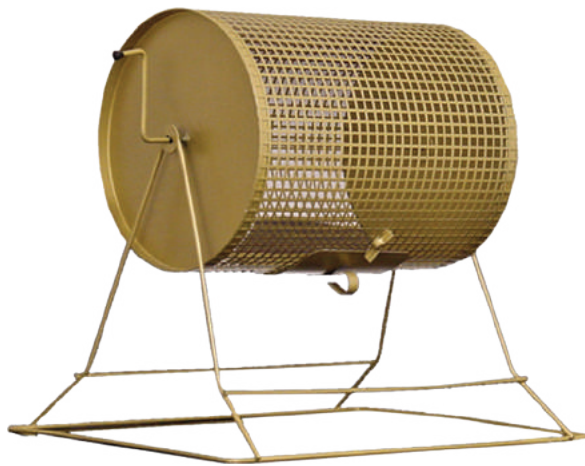

Draw Drums

Get those tickets out because our brass plated draw drums are ready to roll. Available in four sizes, our smallest draw drum can hold approximately 2,500 tickets, while our largest can hold approximately 10,000 tickets.

ITEM	KEY#
Small	590-0700
Medium	590-0710
Large	590-0720
Giant	590-0730



Ceasefire Ashstand

590-0690

The Ceasefire cigarette disposal unit is 43" tall and has a 12" diameter base. Large 9 Litre galvanized steel liner bucket is removable for easy cleaning.



5' Rolling Knockdown Coat Rack

590-0350

This chrome plated rolling coat rack features 4 swivel casters that will help you easily move it around. It features slip apart construction so it will easily store. It will fit in a car when disassembled. Designed for the commercial event industry, it's not to be confused with the lighter duty coat racks available in the market.

Ceremonial Scissors

590-0740
20" w/ Case

590-0750
36" w/ Case



Easels

Folding easel for presentation and display use. Holds full size posterboard sheets. Folds easily and conveniently when not in use.



ITEM	KEY#
Silver Vein Alum Folding	590-0233

Shipping Policy

To maintain the lowest possible price on our products, Special Event Sales does not include shipping charges in the price of our products. The cost of shipping is figured for each individual order and is determined by weight and destination. Shipments that do not meet weight and size requirements by ground delivery will be shipped by freight carrier. Freight service includes tailgate delivery only. You are responsible for taking the items off the trailer and into your location. You may request inside delivery and other services for an additional fee. You may use your own shipping method by supplying the information required when placing the order.

All shipments should be carefully inspected by the customer before acceptance. Immediate inspection by the delivery carrier should be requested to record any damage or shortage on the delivery.

Notification of concealed damages must be made to the delivery carrier and Special Event Sales within 7 days of delivery of merchandise.

After obtaining a clear receipt for shipment, the delivery carrier is no longer responsible for damages or shortages. Please inspect all cartons and the products within them for visible damage and count the number of pieces you received. Note any damage or discrepancies on the carrier's delivery receipt. If there is any visible damage, or if you discover any concealed damage during unpacking, do not remove the merchandise or throw away the shipping carton. If for some reason you are unable to inspect the items at the time of delivery, please sign the freight bill as "subject to inspection".

Return Policy

The customer is responsible for the accuracy of items ordered: colours, sizes, options, etc. An order confirmation is provided for approval. Excluding Special Event Sales errors, the following instructions must be followed to return and/or exchange products ordered in error.

No Product May Be Returned 30 Days After Delivery Date.

The customer is responsible for freight charges to and from our warehouse. Returned goods will not be accepted without a Return Materials Authorization (RMA) given by Special Event Sales. A 25% restocking fee applies to all returns received in re-sellable condition. No credit will be given for items damaged in transit.

Warranty

All products carry a minimum of a one year warranty unless otherwise stated. Warranty coverage is limited to defects in manufacturing and designs. Exclusions include abuse, misuse, extreme weather, and other force majeure. Products may be replaced or repaired at Special Event Sales' expense. Warranty service is FOB Edmonton/Woodstock.



Payment Options

We accept Visa, Master Card, American Express, Debit, Cheques, Bank Drafts and Direct Deposit. Credit card transactions greater than \$5000.00 will be subject to a 3% surcharge. We also accept purchase orders under certain terms. All Special Event Sales products are priced in Canadian dollars. Our systems are very secure and all customer information is kept private. We gladly accept purchase orders from Schools, Universities and Government Organizations subject to the following terms and conditions:

- Purchase orders will only be accepted for Special Event Sales accounts in writing via fax (780-437-4964), a PDF file attached to an email (sent to sales@specialeventsales.com) or mailed to:

Special Event Sales Ltd.
7063 68 Ave NW
Edmonton, Alberta
T6B 3E3

Sales Tax

Items shipped to destinations in Canada are subject to GST sales tax of 5%.

Order Confirmation

You will receive an "order confirmation" email within 24 hours of placing your order. The email confirmation will list all items in your order and serve as your invoice. If you do not receive your order confirmation after 24 hours, please send an email to sales@specialeventsales.com. Be sure to include your account email address and order number. We will send a new confirmation to you.

PRICES ARE SUBJECT TO CHANGE WITHOUT NOTICE.



SPECIAL *Event* SALES

📍 7063 68 Ave NW
Edmonton AB T6B 3E3

📍 Unit 5, 454 Innovation Way
Woodstock ON N4V 0A2

☎ 780-430-8911

☎ 416-613-2211

✉ sales@specialeventsales.com

www.specialeventsales.com