

R129/03
100 – 150cm
≤36kg

COSATTO[®]
clever stuff for happy babies

The ABCs

Ninja 2 i-Size
i-Size Booster Seat



(EN) Instruction

1 - 56

(FR) Instruction, (DE) Gebrauchsanleitung, (IT) Istruzioni,
(PT) Instrução, (RU) Инструкция, (ZH) 说明, (ES) Instrucciones

(EN) Part list diagram

57

(FR) Schéma de nomenclature, (DE) Teilelisteabbildung,
(IT) Diagramma della lista delle parti, (PT) Diagrama de lista de peças,
(RU) Схема к спецификации деталей, (ZH) 零件清单图,
(ES) Diagrama de lista de piezas

(EN) Spare part list diagram

58

(FR) Schéma de pièces détachées, (DE) Ersatzteillisteabbildung,
(IT) Diagramma della lista delle parti di ricambio,
(PT) Diagrama de lista de peças sobresselentes,
(RU) Схема к спецификации запчастей, (ZH) 备件清单图,
(ES) Diagrama de lista de piezas de repuesto

(EN) Instruction diagram

59 - 65

(FR) Schéma d'instructions, (DE) Anleitungsdiagramm,
(IT) Diagramma di istruzioni, (PT) Diagrama de instruções,
(RU) Схема к инструкции, (ZH) 说明图, (ES) Diagrama de instrucciones

(EN) Forward facig mode (100 - 150 cm) - ISOFIT option

66 - 93

(FR) Position face à la route (100 - 150 cm) - Option ISOFIT,
(DE) Vorwärtsrichtung (100 - 150 cm) - ISOFIT-Option,
(IT) Modalità rivolta in avanti (100 - 150 cm) - Opzione ISOFIT,
(PT) Modo virado para a frente (100 - 150 cm) - Opção ISOFIT,
(RU) Лицом по ходу движения (100 - 150 см) - Опция ISOFIT,
(ZH) 前向安装模式 (100 - 150 公分) - ISOFIT 选择,
(ES) Modo en sentido de la marcha (100 - 150 cm) - Opcion ISOFIT

(EN) Forward facig mode (100 - 150 cm) - Belted option

94 - 121

(FR) Position face à la route (100 - 150 cm) - Mode ceinture,
(DE) Vorwärtsrichtung (100 - 150 cm) - Gegurtete Option,
(IT) Modalità rivolta in avanti (100 - 150 cm) - Opzione cinture di sicurezza,
(PT) Modo virado para a frente (100 - 150 cm) - Opção de cinto,
(RU) Лицом по ходу движения (100 - 150 см) - Вариант со штатным
ремнем безопасности,
(ZH) 前向安装模式 (100 - 150 公分) - 安全带选择,
(ES) Modo en sentido de la marcha (100 - 150 cm) - Opcion de cinturon

Important: Keep these instructions for future reference.

Important safety Information

The instruction manual should be kept safely with child car seat for its life period: There is a compartment at the side of the child car seat for storage of the instruction manual.

It is recommended to check that the child restraint is compatible with the intended vehicle at the time of purchase.

Please refer to the vehicle list, Cosatto fit checker app (<http://cosat.to/fitchecker>) or the vehicle fitting list section on the website (<http://cosat.to/ninja2isizevl>).

Seat positions in other vehicles may also be suitable to accept the child restraint. If in doubt, consult either Cosatto or the retailer.

Child age and weight:

- The car seat is suitable for height between 100 and 150 cm, up to maximum weight of 36 kg.
- **IMPORTANT - DO NOT USE FORWARD FACING BEFORE THE CHILD'S AGE EXCEEDS 15 MONTHS.**

Location:

- Refer to the vehicle list for information of where the child car seat base will fit in your vehicle.
- Never use the child car seat on a seat where an airbag is fitted and active. Refer to your vehicle user manual for information on de-activating the airbag.
- If the vehicle seat backrest has a recline function, place the vehicle seat in the most upright position when using the child car seat.
- Do not use the child car seat in the home. It has not been designed for home use and should only be used in your car.

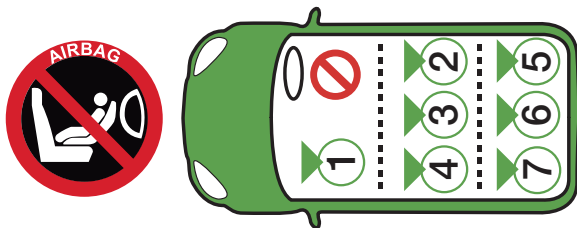

Safety - Please read carefully:

- **NEVER** use this child car seat with its side facing the vehicle seat.
- Any rigid items and plastic parts of the child car seat must be so located and installed that they are not liable, during everyday use of the vehicle, to become trapped by a movable seat or in a door of vehicle.
- If any load bearing points other than those described in the instructions are used, this can significantly reduce the protection factor of the child car seat.
- **ALWAYS** secure your child with the safety harness when using this child car seat.
- Never leave your child unattended.
- Do not attempt to dismantle, modify or add to any part of the child car seat or change the way your vehicle seat belts are made or used.
- After an accident the child car seat should be replaced and the vehicle seat belts. Although they may look undamaged, they may not protect your child as well as they should.
- Do not place anything such as a towel or cushion under the child car seat. This could affect the performance of the child restraint system in an accident.
- Any vehicle seat belt holding the child car seat to the vehicle should be tight, and that belt should not be twisted.
- Always make sure that the vehicle seat belt is correctly tensioned to ensure maximum protection for your child.
- Prevent vehicle seat belt from getting trapped between car doors or rubbing against sharp parts of the seat or body.
- If the vehicle belt becomes cut or frayed, replace it before travelling.
- Never use replacement parts other than those approved by Cosatto.
- Cosatto advise that child car seat should not be bought or sold second-hand. Many child car seat acquired this way have been found to be dangerous.
- **NOTE:** The child car seat can mark vehicle seat upholstery. Cosatto cannot be held responsible for damage or marking to vehicle seat upholstery.
- Security is only guaranteed if the child car seat is fitted in accordance with these instructions.
- Safely secure any luggage or other objects that might cause injuries to the occupant of the child car seat in the event of a collision.
- Failure to comply with the instructions would be dangerous, and will automatically void the warranty and exempt Cosatto from any liability.
- The harness buckle has been designed to be released quickly in an emergency. **IT IS NOT CHILD PROOF.** More inquisitive children may learn to undo the buckle. Children should be told never to play with the harness buckle or any other part of the child car seat.
- The lap vehicle seat belt must be worn in such a way as to properly secure the pelvis of the child.
- Never use the child car seat without its fabric cover because the fabric cover constitutes as an integral part of the child car seat performance. The fabric cover should not be replaced with any other than the ones recommended by Cosatto.
- Cover the child car seat if it is left in direct sun light for prolonged period as the child car seat base surfaces may get very hot. Check the child car seat surface before placing your child in the seat.

- **WARNING:** To avoid risk of injury from burning, do not place hot beverage on drink holder.
- Drink holder - maximum weight 500g.
- Failure to comply with the instructions would be dangerous, and will automatically void the warranty and exempt Cosatto from any liability.

Notice:

1. (100 - 150cm) This is an i-Size booster seat Enhanced Child Restraint System. It is approved according to UN Regulation No.129, for use primarily in "i-Size seating positions" as indicated by vehicle manufacturers in the vehicle user's manual.
2. Never use this child car seat on passenger seat fitted with an active airbag is installed.
3. If in doubt, consult either the child restraint manufacturer or retailer.

Care & Maintenance:

- Your child restraint system has been designed to meet safety standards and with correct use and maintenance will give many years of trouble free performance.
- Store your child restraint system in a dry, safe place.
- Storing a damp child restraint system will encourage mildew to form, so after exposure to damp conditions, dry off with a soft cloth and allow to dry thoroughly before storing.
- Avoid leaving the child restraint system in sunlight for prolonged periods as this may cause fabrics to fade.
- Inspect the child restraint system regularly for signs of damage- stop using the product if damage is found.
- **DO NOT** take apart, or attempt to take apart the child restraint system when cleaning. It is unnecessary and dangerous to do so.
- Plastic and metal parts may be sponged clean with warm water and a mild detergent.
- Refer to the wash care on soft goods for cleaning instruction.
- Remove insert from seat cover/ seat liner prior to cleaning.
- Never clean with abrasive, ammonia based, bleach based or spirit type cleaners.

Visual language Key:

	Refer to warning XX		Repeat action x times		Press and hold
	Correct action		General action arrow		Check
	Incorrect action		Lock		Continue to step XX
	Audible sound		Unlock		Repeat on other side

Part List:

Please refer to diagrams:

P1: Headrest

P2: Backrest

P3: Seat

P4: ISOFIX arm

P5: ISOFIX guide (x2)

P6: Storage compartment

P7: Drink holder

Replacement Parts:

The replacement parts shown below are available for your product. For UK & Ireland customers, order through our website: <http://www.cosatto.com/service-centre/spares>
For customer outside UK & Ireland, contact information for your local distributor can be found on <http://www.cosatto.com/stockists>

If you require any further assistance, please contact us at cuddle@cosatto.com

S1: Headrest Fabric Cover

S2: Backrest Fabric Cover

S3: Base Fabric Cover

S4: Headrest Centre Insert

S5: Headrest Side wing insert (set)

S6: Backrest Insert (set)

S7: ISOFIX guide (set)

S8: Drink Holder

Fitting & Operation Information:

Please refer to the following diagrams:

Backrest

1-

Preparation:

Connect the backrest section to the base section (a) and raise the backrest to the upright position (b).

Location

2-

IMPORTANT: Never use the child car seat on a seat where an airbag is fitted and active. Refer to your vehicle user manual for information on de-activating the airbag.

WARNING: Your child car seat can only be installed forward facing using a three point lap and diagonal vehicle belt in the front or rear passenger seats of the car.

ISOFIX arm

3-

Location:

The two ISOFIX low anchorage anchor points are usually located between the vehicle seat base and back (a).

Some vehicles have ISOFIX indicator near the ISOFIX low anchorage anchor points (b).

4-

Fitting the ISOFIX guides (Optional):

The ISOFIX guides can help identify the vehicle ISOFIX anchor points and make installation easier. They can also help with the protection of your vehicle seat.

5-

Fitting:

Press and hold ISOFIX arm adjustment buttons and extended the arms fully (a).

Engage the ISOFIX arms (b) and ensure that the ISOFIX arm security indicators are green (c).

Push the base back until it rests firmly against the vehicle seat backrest (d).

Removal is a reversal of this procedure.

- Headrest** 6- **Adjusting:**
- 7- **Satisfactory headrest position:**
- Belted with ISOFIX arms only** 8- **Fitting:**
Position the child car seat on the vehicle seat, forward facing (a). Attach the ISOFIX arms to the anchor points (refer to step 5) (b). Secure your child with vehicle belt (refer to step 9 - 10) (c). Removal is a reversal of this procedure.
- Vehicle belt** 9- Place your child into the child car seat.
Pull the vehicle belt out and around the child (a) and fasten the buckle (b).
The lap vehicle belt should be threaded through lap vehicle belt guides (c) under the armrests.
Fit the diagonal vehicle belt through the headrest diagonal vehicle belt guide (d).
- 10- Tension the vehicle belt (a & b).
IMPORTANT: The position of the vehicle belt buckle can affect the stability of the child restraint system. In an accident this could stop the child restraint system from protecting your child as well as it should. After tightening the vehicle belt, if the buckle lies in the position marked (X) then try fitting the child restraint system in another seating position in your vehicle.
Removal is a reversal of this procedure.
- Belted only** 11- **Fitting:**
Position the child car seat on the vehicle seat, forward facing (a). Retract the ISOFIX arms (refer to step 5) (b). Secure your child with vehicle belt (refer to step 9 - 10) (c). Removal is a reversal of this procedure.
- Softgoods** **Removing:**
- 12- Raise the headrest to its highest position (a, refer to step 6). Unfasten the headrest adjustor strap (b) and poppers (c) at the rear of the headrest fabric cover.
Release the headrest fabric cover from the headrest diagonal vehicle belt guides (d) and remove the fabric cover.
- 13- Disconnect the backrest section from the base section (a). Disconnect the elastic loops from the backrest section (b). Disconnect the retaining straps from the base section (c). Remove the backrest fabric cover and base fabric cover.
Reverse the procedures above to refit the softgoods.
- Drink holder** 14- **Fitting:**

Checklist:

- Have you check the compatibility of the child car seat with the intended vehicle?
- If applicable, is the air-bag de-activated?
- Is your child car seat correctly fitted to the vehicle seat?
- Have you check the safety indicators on ISOFIX arms?
- Is your child correctly secure in the child car seat?
- Is harness adequately tensioned and not twisted?

- For seating positions for other fitting options, please refer to the Cosatto fit checker app (<http://cosat.to/fitchecker>) or the vehicle fitting list section on the website (<http://cosat.to/ninja2isizevl>).
- The numbers in the vehicle diagram below correspond with the seat positions listed in the vehicle fitting list.

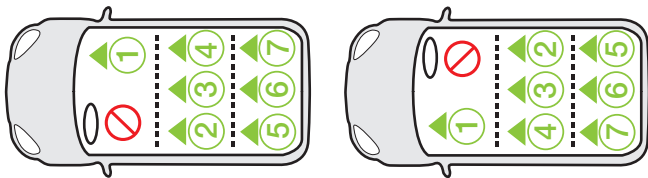

- If the child restraint can be fitted, the suitable seat position(s) is marked with ●
- If the child restraint cannot be fitted, the suitable seat position(s) is marked with ○
- Electric or hybrid vehicles are marked with ⚡
- i-Size vehicles are marked with 
- Vehicles with under-floor storage compartment(s) is marked with **SB!** - Please consult the vehicle's handbook prior to fitting this child restraint in these vehicles.
- Vehicles with a cabin roof height which could restrict the child restraint from being installed forward facing are marked with **!**
- If your vehicle is not listed in this list or it is not marked with either a ● or ○ then please refer to the vehicle's handbook or contact Cosatto or retailer for further information.
- Seat positions in other vehicles may also be suitable to accept the child restraint. If in doubt, consult either Cosatto or the retailer.



Prior to purchase the vehicle, check that it is equipped with the appropriate anchorages.

ALWAYS give priority to the rear vehicle seats.



DO NOT fit the child restraint onto a vehicle seat fitted with an airbag, unless it can be, and is deactivated. Death or serious injuries can be caused by an activated AIRBAG system.

- This vehicle fitting list was carefully prepared using scientific data collected from both vehicle and child restraint. Cosatto accepts no liability whatsoever with regards to any inaccuracies of the list, which is intended for guidance purposes only.
- It is recommended to check that the child restraint is compatible with the intended vehicle at the time of purchase.

Important : conservez ce moded'emploi afin de pouvoir le consulter ultérieurement.

Informations importantes de sécurité.

FR

Le mode d'emploi doit être conservé avec le siège-auto pour enfant tout au long de sa période d'utilisation:

Un compartiment sur le côté du siège auto pour enfant pour ranger le manuel d'instructions.

Il est recommandé de vérifier que le dispositif de retenue pour enfants est compatible avec le véhicule au moment de l'achat.

Veillez vous référer à la liste des véhicules, à l'application Cosatto de vérification de l'installation (<http://cosat.to/fitchecker>) ou à la liste d'installation véhicule du site Internet (<http://cosat.to/ninja2isizevl>).

Les positions de siège dans d'autres véhicules peuvent également convenir pour l'installation du dispositif de retenue pour enfants. En cas de doute, veuillez prendre contact avec Cossato ou le revendeur.

Taille et poids de l'enfant:

- Le siège auto convient à une hauteur comprise entre 100 et 150 cm, jusqu'à un poids maximum de 36 kg.
- **IMPORTANT – N'ORIENTEZ PAS LE SIÈGE-AUTO FACE À LA ROUTE SI L'ENFANT N'A PAS AU MOINS 15 MOIS.**

Emplacement:

- Reportez-vous à la liste des véhicules pour connaître les places où le socle de siège-auto peut être installé.
- N'utilisez jamais ce siège-auto sur un siège pour lequel un airbag est activé. Consultez le manuel du véhicule pour désactiver l'airbag.
- Si le dossier du siège du véhicule est inclinable, positionnez-le le plus droit possible lorsque vous utilisez le siège-auto.
- n'utilisez PAS le siège-auto chez vous. Il n'a pas été conçu pour un usage au domicile et ne doit être utilisé que dans votre véhicule.

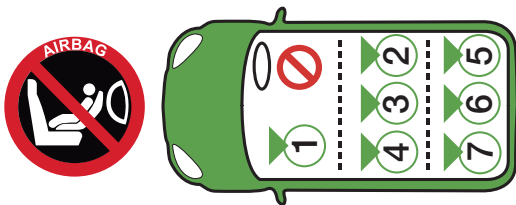

Sécurité - Veuillez lire attentivement :

- N'utilisez **JAMAIS** ce siège-auto en position latérale.
- Tous les éléments rigides et les pièces en plastique du siège-auto doivent être situés et installés de sorte qu'ils ne soient pas, lors de l'utilisation quotidienne du véhicule, coincés sous un siège mobile ou dans une porte du véhicule.
- Si des points de charge autres que ceux indiqués dans le mode d'emploi sont utilisés, cela peut réduire considérablement le facteur de protection du siège-auto.
- Attachez **TOUJOURS** votre enfant au moyen du harnais de sécurité lors de l'utilisation de ce siège-auto.
- Ne laissez **JAMAIS** votre enfant sans surveillance.
- N'essayez **PAS** de démonter, de modifier ou d'ajouter toute partie du dispositif de retenue pour enfant ni de changer la façon dont les ceintures de sécurité du véhicule sont conçues ou utilisées.
- Le dispositif de retenue pour enfant et les ceintures de sécurité du véhicule doivent être remplacés après un accident. Bien qu'ils puissent sembler en bon état, ils peuvent ne pas protéger votre enfant aussi bien qu'ils le devraient.
- Ne placez rien sous le siège-auto (par exemple une serviette ou un coussin). Cela pourrait affecter la performance du siège-auto en cas d'accident.
- La ceinture du véhicule maintenant le dispositif de retenue pour enfant au siège doit être correctement serrée et ne doit pas être torsadée.
- Assurez-vous toujours que le harnais du siège-auto et la ceinture du véhicule soient correctement tendus afin d'assurer une protection maximale de votre enfant.
- Ne laissez pas le harnais et la ceinture du véhicule se trouver pincés par les portes du véhicule ni frotter contre des arêtes vives du siège ou du châssis.
- Si le harnais ou la ceinture du véhicule sont coupés ou effilochés, remplacez-les avant de conduire.
- Utilisez toujours des pièces de rechange approuvées par Cosatto.
- Cosatto conseille de ne pas acheter ni vendre de sièges-auto d'occasion. De nombreux sièges-auto achetés de cette façon se sont avérés être dangereux.
- **REMARQUE** : le siège-auto peut marquer la garniture des sièges du véhicule. Cosatto ne peut être tenue responsable des dommages ou des marques laissées sur la garniture des sièges du véhicule.
- La sécurité n'est garantie que si le siège-auto est installé conformément à ces instructions.
- Attachez solidement les bagages ou autres objets qui pourraient blesser l'occupant du siège-auto en cas d'accident.
- Le non-respect de ces instructions crée une situation dangereuse, annule automatiquement la garantie et dégage Cosatto de toute responsabilité.
- La boucle du harnais a été conçue de façon à être libérée rapidement en cas d'urgence. **UN ENFANT PEUT L'ACTIONNER.** Les enfants plus curieux peuvent apprendre à défaire la boucle. Vous devez leur dire de ne jamais jouer avec la boucle du harnais, ni avec toute autre partie du siège-auto.
- Il est important que la sangle abdominale du harnais soit serrée bien en bas, de sorte que le bassin de l'enfant soit fermement maintenu.
- Lorsqu'il est utilisé en mode rehausseur, la ceinture ventrale du véhicule doit être correctement ajustée sur le bassin de l'enfant.
- N'utilisez jamais le siège-auto sans sa housse en tissu, celle-ci contribue à sa performance intégrale. En cas de remplacement de la housse en tissu, utilisez toujours une housse recommandée par Cosatto.

- **AVERTISSEMENT:** Pour éviter tout risque de brûlure, ne placez aucune boisson chaude dans le porte-gobelet.
- Porte-gobelet - poids maximum 500 g.
- Le non-respect de ces instructions crée une situation dangereuse, annule automatiquement la garantie et dégage Cosatto de toute responsabilité.













Remarques:

1. (100 - 150cm) Il s'agit d'un siège d'appoint amélioré i-Size. Il est approuvé conformément au Règlement n° 129, pour une utilisation principalement dans les « positions assises i-Size » comme indiqué par les constructeurs de véhicules dans le manuel d'utilisation du véhicule.
2. N'utilisez jamais ce siège-auto sur le siège passager si l'airbag est activé.
3. En cas de doute, veuillez prendre contact avec le fabricant ou le revendeur du dispositif de retenue pour enfant.

Entretien:

- Votre dispositif de retenue pour enfant a été conçu pour répondre aux normes de sécurité et une utilisation et un entretien appropriés vous garantiront de nombreuses années d'utilisation sans problème.
- Rangez le dispositif de retenue pour enfant dans un endroit sûr et sec.
- Le rangement du dispositif de retenue pour enfant humide favorise la formation de moisissures. S'il est humide, séchez-le avec un chiffon doux et laissez-le sécher complètement avant de le ranger.
- Évitez de laisser le dispositif de retenue pour enfant longtemps au soleil, car la couleur des tissus peut s'estomper.
- Inspectez régulièrement le dispositif de retenue pour enfant pour vérifier l'absence de dommage. Cessez de l'utiliser si l'un des éléments est endommagé.
- Ne démontez **PAS** et n'essayez **PAS** de démonter les éléments du dispositif de retenue pour enfant lors de son nettoyage. Cela serait inutile et pourrait être dangereux.
- Les pièces métalliques et en plastique peuvent être nettoyées en les épongeant avec de l'eau tiède et un détergent doux.
- Les instructions de nettoyage des articles en tissu sont indiquées sur leurs étiquettes de lavage respectives.
- Retirer l'insert du réducteur / de la housse avant le nettoyage.
- N'utilisez jamais de détergent abrasif ou à base d'ammoniaque, d'eau de Javel ou d'alcool.

Signification des symboles :

	Reportez-vous à l'avertissement XX		Répétez l'action x fois		Appuyez et maintenez
	Action correcte		Flèche d'action générale		Vérifiez
	Action incorrecte		Verrouillez		Passez à l'étape XX
	Signal sonore		Déverrouillez		Répétez de l'autre côté

Lista delle parti:

Si prega di far riferimento ai diagrammi:

P1: Appui-tête
P2: Dossier
P3: Siège
P4: Bras ISOFIX

P5: Guide ISOFIX (x2)
P6: Compartiment de rangement
P7: Porte-gobelet

Parti di ricambio

Le parti di ricambio disponibili sono elencate qui di seguito. Per il Regno Unito e l'Irlanda è possibile ordinare tramite il nostro sito web: <http://www.cosatto.com/service-centre/> spares I clienti al di fuori del Regno Unito e dell'Irlanda possono contattare il distributore locale indicato su <http://www.cosatto.com/stockists>
In caso di ulteriore assistenza, non esitate a contattarci all'nostro indirizzo email: cuddle@cosatto.com

S1: Housse d'appui-tête

S5: Inserts latéraux d'appui-tête (jeu)

S2: Housse de dossier

S6: Insert de dossier (jeu)

S3: Housse de base

S7: Guide ISOFIX (jeu)

S4: Insert central d'appui-tête

S8: Porte-gobelet

Informations d'installation et d'utilisation:

Reportez-vous aux schémas d'instructions :

Dossier

1-

Préparation:

Connectez la section de dossier à la section de base (a) et inclinez le dossier en position verticale (b).

Emplacement

2-

IMPORTANT: n'utilisez jamais ce siège-auto sur un siège de véhicule pour lequel un airbag est activé. Consultez le manuel du véhicule pour désactiver l'airbag.

AVERTISSEMENT: votre siège-auto peut uniquement être orienté face à la route en utilisant une ceinture de sécurité ventrale et diagonale à 3 points d'ancrage sur les sièges avant ou arrière du véhicule.

Bras ISOFIX

3-

Emplacement:

Les deux points d'ancrage ISOFIX inférieurs se trouvent généralement entre l'assise et le dossier du siège du véhicule (a). Certains véhicules disposent d'un marquage ISOFIX près des points d'ancrage ISOFIX inférieurs (b).

4-

Installation des guides ISOFIX (En option):

Les guides ISOFIX facilitent l'identification des points d'ancrage ISOFIX et l'installation. Ils permettent également de protéger le siège du véhicule.

5-

Installation :

Appuyez sur les boutons de réglage des bras ISOFIX tout en sortant complètement les bras (a).
Enclenchez les bras ISOFIX (b) et vérifiez que les indicateurs de sécurité des bras ISOFIX sont verts (c).
Poussant le socle de siège-auto fermement contre le dossier du siège du véhicule (d).
Procédez dans l'ordre inverse pour le retrait.

- Appui-tête** 6- **Réglage :**
7- **Position correcte de l'appui-tête :**
- Ceinture avec bras ISOFIX uniquement:** 8- **Installation :**
Placez le siège-auto sur le siège du véhicule, face à la route (a). Fixez les bras ISOFIX aux points d'ancrage (voir les étapes 5) (b). Sécurisez votre enfant avec la ceinture du véhicule (voir les étapes 27 - 28) (c).
Procédez dans l'ordre inverse pour le retrait.
- Ceinture du véhicule** 9- Placez votre enfant dans le siège-auto.
Tirez la ceinture du véhicule et faites-la passer devant l'enfant (a), puis attachez-la (b).
La partie ventrale de la ceinture du véhicule doit passer dans les guides de la partie ventrale de la ceinture (c) et sous les accoudoirs.
Faites passer la partie diagonale de la ceinture du véhicule dans le guide de ceinture de l'appui-tête (d).
- 10- Tirez sur la ceinture du véhicule de façon à la tendre (a et b).
IMPORTANT : la position de la boucle de la ceinture du véhicule peut affecter la stabilité du dispositif de retenue pour enfant. En cas d'accident, le dispositif de retenue pour enfant pourrait ne pas protéger correctement votre enfant. Après avoir serré la ceinture du véhicule, si la boucle se trouve dans la position indiquée (X), essayez d'installer le dispositif de retenue pour enfant à une autre place dans votre véhicule.
Procédez dans l'ordre inverse pour le retrait.
- Ceinture uniquement** 11- **Installation:**
Placez le siège-auto sur le siège du véhicule, face à la route (a). Rétractez les bras ISOFIX (voir l'étape 5) (b). Sécurisez votre enfant avec la ceinture du véhicule (voir les étapes 9 - 10) (c).
Procédez dans l'ordre inverse pour le retrait.
- Articles en tissu** 12- **Removing:**
Relevez l'appui-tête à sa position la plus haute (a, voir l'étape 6). Détachez la sangle de réglage de l'appui-tête (b) et les boutons-pression (c) à l'arrière de la couverture en tissu de l'appui-tête. Dégagez la housse en tissu de l'appui-tête des guides diagonaux de la ceinture du véhicule (d) et retirez la housse en tissu.
- 13- Déconnectez la section du dossier de la section de la base (a). Déconnectez les boucles élastiques de la section du dossier (b). Détachez les sangles de retenue de la section de base (c). Retirez le revêtement en tissu du dossier (a) et le revêtement en tissu de la base (b).
Suivez les instructions ci-dessus en ordre inverse pour installer les articles en tissu.
- Porte-gobelet** 14- **Installation :**

Liste de contrôle :

- Avez-vous vérifié la compatibilité du dispositif de retenue pour enfant avec le modèle du véhicule ?
- Le cas échéant, l'air-bag est-il désactivé ?
- Le dispositif de retenue pour enfant est-il correctement installé sur le siège du véhicule ?
- Le siège-auto est-il correctement installé sur le dispositif de retenue pour enfant ?
- Avez-vous vérifié les indicateurs de sécurité sur les bras ISOFIX, le pied de soutien ISOFIX et la sécurité du siège ?
- L'enfant est-il correctement attaché dans le siège-auto ?
- Le harnais est-il correctement tendu et non torsadé ?

- Pour les positions pour d'autres options d'installation, veuillez vous référer à l'application Cosatto de vérification de l'installation (<http://cosat.to/fitchecker>) ou à la liste d'installation véhicule du site Internet (<http://cosat.to/ninja2sizevl>).
- Les numéros dans le schéma de véhicule ci-dessous correspondent aux positions de siège répertoriées dans la liste d'installation véhicule.

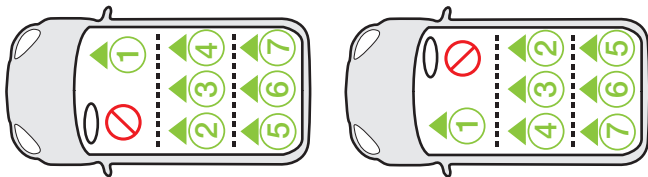

- Si le dispositif de retenue pour enfants peut être installé, la ou les positions de siège appropriées sont identifiées par ●
- Si le dispositif de retenue pour enfants ne peut pas être installé, la ou les positions de siège correspondantes sont identifiées par ○
- Les véhicules électriques ou hybrides sont identifiés par ⚡
- Les véhicules « i-Size » sont identifiés par 
- Les véhicules avec compartiment(s) de rangement au niveau du plancher sont identifiés par **SB!** - Veuillez consulter le manuel du véhicule avant d'installer ce dispositif de retenue pour enfants dans ces véhicules.
- Les véhicules dont la hauteur du toit dans la cabine peut empêcher l'installation du siège face à la route sont identifiés par !
- Si votre véhicule ne figure pas dans cette liste ou s'il n'est pas identifié par ● i ○ , alors consultez le manuel du véhicule ou contactez Cosatto ou le revendeur pour plus d'informations.
- Les positions de siège dans d'autres véhicules peuvent également convenir pour l'installation du dispositif de retenue pour enfants. En cas de doute, veuillez prendre contact avec Cosatto ou le revendeur.



Avant d'acheter le véhicule, vérifiez qu'il est équipé des points d'ancrage appropriés.

Donnez TOUJOURS la priorité aux sièges arrière du véhicule.



N'installez PAS le dispositif de retenue pour enfants sur le siège d'un véhicule équipé d'un airbag à moins qu'il ne soit désactivé. La mort ou des blessures graves peuvent être causées par un système AIRBAG activé.

- Cette liste d'installation véhicule a été soigneusement préparée à l'aide de données scientifiques recueillies à la fois sur le véhicule et sur le dispositif de retenue pour enfants. Cosatto décline toute responsabilité quant à l'exactitude de la liste, fournie uniquement à titre d'information.
- Il est recommandé de vérifier que le dispositif de retenue pour enfants est compatible avec le véhicule au moment de l'achat.

Wichtig: Bitte diese Gebrauchsanweisung aufbewahren.

Wichtige Sicherheitshinweise.

Die Gebrauchsanweisung bitte sorgfältig zusammen mit dem Kinderrückhaltesystem für die Dauer der Nutzung aufbewahren:

An der Seite des Kinderautositzes befindet sich ein Fach zur Aufbewahrung der Bedienungsanleitung.

Es wird empfohlen, beim Kauf darauf zu achten, dass das Kinder-Rückhaltesystem für das vorgesehene Fahrzeug geeignet ist.

Siehe Fahrzeugliste, Cosatto App für den Fahrzeugeinbau (<http://cosat.to/fitchecker>) oder die Fahrzeugeinbauliste auf der Webseite (<http://cosat.to/ninja2isizevl>).

Sitzpositionen in anderen Fahrzeugen können ebenfalls für den Einbau des Kinder-Rückhaltesystems geeignet sein. Im Zweifel, Cosatto oder den Händler kontaktieren.

Größe und Gewicht des Kindes:

- Der Autositz ist für Körpergrößen zwischen 100 und 150 cm geeignet. und einem maximalen Gewicht von 36 kg geeignet.
- **WICHTIG - DEN KINDERSITZ NICHT IN FAHRRICHTUNG VERWENDEN, BIS DAS KIND MINDESTENS 15 MONATE ALT IST.**

Position:

- Zu Angaben, wo sich die Montagepositionen für das Kindersitzuntergestell in Ihrem Fahrzeug befinden, siehe Fahrzeugliste.
- Befestigen Sie nie einen Kindersitz auf einem Fahrzeugsitz, wo ein aktivierter Airbag eingebaut ist. Siehe Fahrzeughandbuch für Hinweise zur Deaktivierung von Airbags.
- Verfügt die Fahrzeugsitzrückenlehne über eine Neigungsfunktion, muss sich bei der Verwendung des Kindersitzes der Fahrzeugsitz in Aufrechtposition befinden.
- Den Kindersitz **NIE** zu Hause verwenden. Der Kindersitz ist nicht für den Heimgebrauch, sondern nur für die Verwendung im Auto vorgesehen.

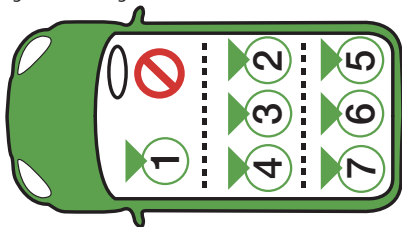

Sicherheit - Bitte sorgfältig durchlesen:

- Den Kindersitz **NIE** mit der Seite zum Fahrzeugsitz verwenden.
- Starre Teile und Kunststoffteile am Kindersitz müssen immer so platziert und installiert werden, dass sie sich bei alltäglichem Gebrauch im Fahrzeug nicht in einem beweglichen Sitz oder der Fahrzeugsitz verfangen können.
- Bei Verwendung von Lastaufnahmepunkten, die nicht in der Gebrauchsanweisung beschrieben werden, kann der Schutzfaktor des Kindersitzes erheblich reduziert werden.
- Bei Verwendung des Kindersitzes, Ihr Kind **IMMER** mit dem Sicherheitsgurt sichern.

- Lassen Sie Ihr Kind **NIE** unbeaufsichtigt.
- Versuchen Sie **NIE** das Kinderrückhaltesystem auseinander zu bauen, zu modifizieren oder andere Teile hinzuzufügen bzw. nehmen Sie keine Änderungen an Ihren Fahrzeuggurten vor und verwenden Sie diesen nur wie vorgesehen.
- Nach einem Unfall müssen Kinderrückhaltesystem und Fahrzeuggurte ausgetauscht werden. Auch wenn diese unbeschädigt erscheinen, kann die Sicherheit Ihres Kindes nicht im vollen Umfang gewährleistet werden.
- Legen Sie kein Handtuch oder Kissen unter den Kindersitz. Das kann sich im Falle eines Unfalls auf die Schutzfunktion des Kindersitzes auswirken.
- Fahrzeuggurte, mit welchen das Kinderrückhaltesystem im Auto befestigt ist, dürfen nicht locker bzw. verdreht sein.
- Um maximale Sicherheit für Ihr Kind zu gewährleisten, darauf achten, dass der Kindersitzgurt und der Fahrzeuggurt immer richtig festgezogen sind.
- Vermeiden Sie, dass der Kindersitzgurt/ Fahrzeuggurt zwischen den Autotüren eingeklemmt wird oder gegen scharfkantige Sitzteile bzw. den Körper reibt.
- Den Kindersitzgurt/Fahrzeuggurt vor Antritt der Fahrt auswechseln, wenn sich an diesem Einschnitte befinden oder dieser Zerfaserung aufweist.
- Verwenden Sie nur von Cosatto zugelassene Ersatzteile.
- Cosatto rät davon ab, Kindersitze weiterzuverkaufen oder aus zweiter Hand zu kaufen. Viele der auf diesem Wege erworbenen Kindersitze wurden als gefährlich eingestuft.
- **HINWEIS:** Der Kindersitz kann auf dem Fahrzeugsitzpolster Abdrücke hinterlassen. Cosatto haftet nicht für Schäden oder Abdrücke auf dem dem Fahrzeugsitzpolster.
- Sicherheit ist nur gewährleistet, wenn der Kindersitz gemäß dieser Anweisungen befestigt wird.
- Befestigen Sie Gepäck oder andere Gegenstände so, dass sie den Insassen im Kindersitz im Falle eines Aufpralls nicht verletzen können.
- Das Nichtbeachten dieser Hinweise verursacht Gefahren, führt zum Verlust des Garantieanspruchs und schließt Cosatto von jeglicher Haftung aus.
- Der Gurtverschluss ist so konzipiert, dass er sich im Notfall schnell öffnen lässt. **DER GURTVERSCHLUSS IST NICHT KINDERSICHER.** Neugierige Kinder können lernen, den Verschluss zu öffnen. Es muss Kindern erklärt werden, dass sie nie mit dem Gurtverschluss oder anderen Bestandteilen des Kindersitzes spielen dürfen.
- Muss der Fahrzeugbeckengurt so angelegt werden, dass das Becken des Kindes richtig gesichert ist.
- Den Kindersitz nie ohne den Stoffbezug verwenden, da dieser Bezug ein wesentlicher Bestandteil für die Sicherheitsfunktion des Kindersitzes ist. Der Stoffbezug darf nur mit von Cosatto empfohlenen Stoffbezügen ausgewechselt werden.
- Bitte decken Sie den Kindersitz ab, wenn er für längere Zeit direkter Sonneneinstrahlung ausgesetzt ist, da die Oberflächen des Kindersitzes sehr heiß werden können. Prüfen Sie den Kindersitz, bevor Sie Ihr Kind hineinsetzen.
- **WARNUNG:** Um Verbrennungen zu verhindern, keine heißen Getränke auf dem Getränkehalter abstellen.
- Getränkehalter - Höchstgewicht 500g.
- Das Nichtbeachten dieser Hinweise verursacht Gefahren, führt zum Verlust des Garantieanspruchs und schließt Cosatto von jeglicher Haftung aus.

Hinweis:

1. (100 -150cm) Dies ist ein verbessertes i-Size-Kinderrückhaltesystem. Es ist gemäß der UN-Regelung Nr. 129 für die Verwendung in erster Linie in "i-Size-Sitzpositionen" zugelassen, wie von den Fahrzeugherstellern in der Bedienungsanleitung des Fahrzeugs angegeben.
2. Den Kindersitz nie auf einem Beifahrersitz mit aktiviertem Airbag befestigen.
3. Wenn Sie sich nicht sicher sind, wenden Sie sich an den Kindersitzhersteller oder Ihren Händler.

Pflege & Wartung:

- Dieses Kinderrückhaltesystem wurde gemäß den Sicherheitsnormen entwickelt, und ist bei richtiger Anwendung und Pflege für viele Jahre funktionstüchtig.
- Bewahren Sie Ihr Kinderrückhaltesystem an einem trockenen, sicheren Ort auf.
- Das Aufbewahren eines feuchten Kinderrückhaltesystems verursacht die Bildung von Schimmel. Sollte das Kinderrückhaltesystem Feuchtigkeit ausgesetzt sein, vor dem Einlagern mit einem Tuch trocknen und warten, bis das Kinderrückhaltesystem vollständig trocken ist.
- Vermeiden Sie es, das Kinderrückhaltesystem für längere Zeit direkter Sonneneinstrahlung auszusetzen, da dadurch die Farben des Stoffbezugs verblassen können.
- Das Kinderrückhaltesystem regelmäßig auf Schäden prüfen – bei Anzeichen von Schäden, das Produkt nicht mehr verwenden.
- Das Kinderrückhaltesystem darf für Reinigungszwecke **NICHT** auseinander gebaut werden. Das Demontieren ist nicht notwendig und zudem gefährlich.
- Komponenten aus Kunststoff und Metall können mit einem Schwamm, etwas warmen Wasser und einem milden Reinigungsmittel gereinigt werden.
- Siehe dazu die Anleitung für das Reinigen von Textilien.
- Vor dem Reinigen die Sitzbeugeinlage / Sitzeinlage entfernen.
- Zum Reinigen nie scheuernde, Ammoniak, Bleichmittel oder Spiritus enthaltende Reinigungsmittel verwenden.

Bildsprachenschlüssel:

	Siehe Warnung XX		Vorgang x-mal wiederholen		Drücken und halten
	Richtig		Pfeil für allgemeine Vorgänge		Prüfen
	Falsch		Schließen		Weiter zu Schritt XX
	Hörbares Geräusch		Öffnen		Auf der anderen Seite wiederholen

Komponentenliste:

Siehe Abbildungen:

- P1: Kopfstütze
 P2: Rückenlehne
 P3: Sitz
 P4: ISOFIX-Rastarm

- P5: ISOFIX-Führung (x2)
 P6: Aufbewahrungsfach
 P7: Getränkehalter

Ersatzteile:

Für dieses Produkt sind die unten aufgeführten Ersatzteile erhältlich. Kunden in Großbritannien & Irland bestellen über unsere Webseite:

<http://www.cosatto.com/service-centre/spares>

Kunden außerhalb Großbritanniens & Irlands finden Kontaktangaben für Händler vor Ort auf unserer Webseite : <http://www.cosatto.com/stockists>

Sollten Sie weitere Hilfe benötigen, kontaktieren Sie uns über cuddle@cosatto.com

S1: Kopfstützen-Stoffbezug

S5: Kopfstützeinsatz für die Seitenfläche (set)

S2: Rückenlehnen-Stoffbezug

S6: Rückenlehnen-Einsatz (set)

S3: Basis-Stoffbezug

S7: ISOFIX-Führung (set)

S4: Kopfstützenmitteleinsatz

S8: Getränkehalter

DE

Befestigung & anwendungshinweise:

Siehe Anleitungsdiagramme:

Rückenlehne 1-

Vorbereitung:

Verbinden Sie das Rückenlehnteil mit dem Basisteil (a) und stellen Sie die Rückenlehne in die aufrechte Position (b).

Position 2-

WICHTIG: Befestigen Sie nie einen Kindersitz auf einem Fahrzeugsitz, wo ein aktivierter Airbag eingebaut ist. Siehe Fahrzeughandbuch für Hinweise zur Deaktivierung von Airbags.

WARNUNG: Ihr Kindersitz darf nur mit einem Dreipunkt-Becken- und Diagonalgurt auf dem Beifahrer- oder Rücksitz des Fahrzeugs in Fahrtrichtung befestigt werden.

ISOFIX-Rastarm 3-

Position:

Die zwei unteren ISOFIX-Befestigungspunkte befinden sich normalerweise zwischen der Sitzfläche und der Rückseite des Fahrzeugsitzes (a).

Manche Fahrzeuge verfügen über eine ISOFIX-Anzeige in der Nähe der unteren ISOFIX-Befestigungspunkte (b).

4-

ISOFIX-Führungen befestigen (Optional):

Die ISOFIX-Führungen können helfen, die ISOFIX-Befestigungspunkte im Fahrzeug zu finden, und machen es somit einfacher den Kindersitz zu installieren. Diese Führungen helfen auch, Ihren Kindersitz zu schützen.

5-

Befestigen:

Die ISOFIX-Einstellknöpfe drücken und gedrückt halten und die Armlehnen vollständig herausziehen (a).

ISOFIX-Rastarme einrasten (b) und prüfen, ob die

Sicherheitsanzeige für den ISOFIX-Rastarm grün anzeigt (c).

Das Gestell nach hinten schieben, bis es fest an der Rückenlehne des Fahrzeugsitzes sitzt (d).

Zum Entfernen, diesen Vorgang in umgekehrter Reihenfolge wiederholen.

- Kopfstütze** 6- **Anpassen:**
7- **Richtige Kopfstützenposition:**
- Nur mit ISOFIX-Armen gegurtet** 8- **Befestigen:**
Position des Kindersitzes im Fahrzeug in Vorwärtsrichtung (a). Die ISOFIX-Arme an den Verankerungspunkten befestigen (Siehe Schritt 5) (b).
Sichern Sie Ihr Kind mit dem Fahrzeuggurt (Siehe Schritt 9 - 10) (c).
Zum Entfernen, diesen Vorgang in umgekehrter Reihenfolge wiederholen.
- Kindersitzgurt** 9- Setzen Sie Ihr Kind in den Kindersitz.
Den Fahrzeuggurt herausziehen, über das Kinder führen (a) und den Verschluss befestigen (b).
Der Beckengurt muss durch die Beckengurtführungen (c) und unter den Armlehnen hindurch gezogen werden.
Den Fahrzeug-Schulterstraggurt durch die Führung des Kopfstützen-Schräggurts des Fahrzeugs führen (d).
10- Fahrzeuggurt festziehen (a & b).
WICHTIG: Die Position des Fahrzeuggurt-verschlusses wirkt sich auf die Stabilität des Kinderrückhaltesystems aus. Bei einem Unfall kann das Kinderrückhaltesystem Ihr Kind eventuell nicht so schützen, wie vorgesehen. Befindet sich der Verschluss nach dem Festziehen des Fahrzeuggurts in der markierten Position (X), muss das Kinderrückhaltesystem auf einem anderen Fahrzeugsitz eingebaut werden.
Zum Entfernen, diesen Vorgang in umgekehrter Reihenfolge wiederholen.
- Nur gegurtet** 11- **Befestigen:**
Position des Kindersitzes im Fahrzeug in Vorwärtsrichtung(a). Ziehen Sie die ISOFIX-Arme zurück (siehe Schritt 5) (b).
Sichern Sie Ihr Kind mit dem Fahrzeuggurt (Siehe Schritt 9 - 10) (c).
Zum Entfernen, diesen Vorgang in umgekehrter Reihenfolge wiederholen.
- Textilen Komponenten** 12- **Entfernen:**
Stellen Sie die Kopfstütze in die höchste Position (a, siehe Schritt 6).
Lösen Sie den Kopfstützen-Feststellriemen (b) und die Druckknöpfe (c) an der Rückseite des Kopfstützen-Stoffbezugs.
Lösen Sie den Kopfstützen-Stoffbezug von den diagonalen Gurtführungen der Kopfstütze (d) und entfernen Sie den Stoffbezug.

- 13- Lösen Sie das Rückenlehnenteil vom Basisteil (a).
Lösen Sie die elastischen Schlaufen vom Rückenlehnenteil (b).
Lösen Sie die Haltegurte vom Basisteil (c).
Entfernen Sie den Rückenlehnen-Stoffbezug (a) und den Stoffbezug der Basis (b).
Zum Wiederanbringen der Textilien, die Schritte wie oben in umgekehrter Reihenfolge durchführen.

Getränkehalter 14- **Befestigen:**

Prüfliste:

- Haben Sie die Kompatibilität des Kindersitzes mit dem zu verwendenden Fahrzeug überprüft?
- Falls zutreffend, ist der Airbag deaktiviert?
- Ist Ihr Kindersitz richtig am Fahrzeugsitz installiert?
- Haben Sie die Sicherheitsindikatoren an den ISOFIX Rastarmen, dem ISOFIX Stützfuß und der Sitzsicherung überprüft?
- Ist Ihr Kind im Kindersitz richtig gesichert?
- Sind Fahrzeuggurt und Gurtgeschirr ausreichend gespannt und nicht verdreht?

- Für Befestigungsoptionen bei anderen Sitzpositionen, siehe Cosatto App für Sitzprüfung (<http://cosat.to/fitchecker>) oder Abschnitt Fahrzeugeinbauliste auf der Webseite (<http://cosat.to/ninja2isizevl>).
- Die Zahlen im Fahrzeugdiagramm unten stimmen mit den Sitzpositionen in der Fahrzeugeinbauliste überein.

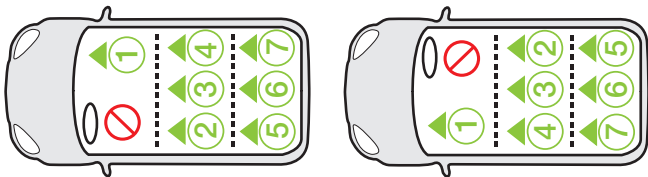

- Wenn das Kinder-Rückhaltesystem eingebaut werden kann, sind die geeigneten Sitzpositionen markiert mit ●
- Wenn das Kinder-Rückhaltesystem nicht eingebaut werden kann, sind die geeigneten Sitzpositionen markiert mit ○
- Elektrische oder Hybrid-Fahrzeuge sind markiert mit ⚡
- i-Size Fahrzeuge sind markiert mit 
- Fahrzeuge mit Bodenaufbewahrungsfächern sind markiert mit **SB!** - Bitte lesen Sie das Fahrzeughandbuch, bevor Sie dieses Kinder-Rückhaltesystem in diesen Fahrzeugen befestigen.
- Fahrzeuge, bei denen die Deckenhöhe die Installation des Kinder-Rückhaltesystems in Vorwärtsrichtung einschränkt, sind markiert mit !
- Ist Ihr Fahrzeug nicht in der Liste aufgeführt oder ist nicht mit ● oder ○ markiert, dann bitte im Fahrzeughandbuch nachsehen oder Ihren Cosatto Händler für weitere Informationen kontaktieren.
- Sitzpositionen in anderen Fahrzeugen können ebenfalls für den Einbau des Kinder-Rückhaltesystems geeignet sein. Im Zweifel, Cosatto oder den Händler kontaktieren.



Vor dem Kauf darauf achten, dass das Fahrzeug mit den geeigneten Verankerungspunkten versehen ist.

Priorität sollten IMMER die Rücksitze des Fahrzeugs haben.



Das Kinder-Rückhaltesystem NIE auf einem Fahrzeugsitz mit Airbag befestigen, es sei denn, der Airbag kann deaktiviert werden oder ist deaktiviert. Ein aktiviertes AIRBAG-System kann zu tödlichen oder schweren Verletzungen führen.

- Diese Fahrzeugeinbauliste wurde anhand von wissenschaftlichen Daten von Fahrzeugen und dem Kinder-Rückhaltesystem sorgfältig zusammengestellt. Cosatto übernimmt keine Haftung bezüglich eventueller Unrichtigkeiten in der Liste, welche lediglich als Orientierungshilfe dienen soll.
- Es wird empfohlen, beim Kauf darauf zu achten, dass das Kinder-Rückhaltesystem für das vorgesehene Fahrzeug geeignet ist.

Attenzione: Conservare le istruzioni per consultazioni future.

Informazioni sulla sicurezza.

Si consiglia di conservare il manuale di istruzioni con il seggiolino per tutto il suo utilizzo: Sul lato del seggiolino è presente uno scomparto per riporre il manuale di istruzioni.

Si consiglia di verificare che il sistema di ritenuta bambini sia compatibile con il veicolo al momento dell'acquisto.

Si prega di fare riferimento alla lista dei veicoli, all'applicazione Cosatto fit checker (<http://cosat.to/fitchecker>) o alla sezione relativa alla compatibilità del veicolo sul sito web (<http://cosat.to/ninja2isizevl>).

Anche i posti a sedere di altri veicoli possono essere adatti ad accogliere il sistema di ritenuta bambini. In caso di dubbio, consultare la Cosatto o il rivenditore.

Peso e altezza del bambino:

- Il seggiolino auto è adatto per un'altezza compresa tra 100 e 150 cm, fino ad un peso massimo di 36 kg.
- **ATTENZIONE- NON UTILIZZARE IL SEGGIOLINO RIVOLTO VERSO L'INTERNO PRIMA CHE IL BAMBINO ABBA RAGGIUNTO I 15 MESI DI ETÀ.**

Posizionamento:

- Fare riferimento alla lista di veicoli per controllare la compatibilità.
- Non utilizzare mai il seggiolino su un sedile dotato di airbag attivo. Fare riferimento al manuale del veicolo per istruzioni su come disattivare l'airbag.
- Se lo schienale del sedile può essere reclinato, scegliere la posizione più verticale quando si usa il seggiolino.
- Non usare mai il seggiolino in casa. Non è progettato per uso domestico ma esclusivamente per l'auto.

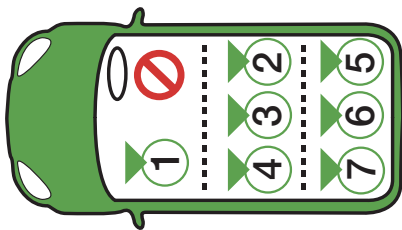

Sicurezza-Si prega di leggere con attenzione:

- Non usare **MAI** il seggiolino sul sedile del passeggero con airbag attivo.
- Tutte le parti rigide e in plastica del seggiolino devono essere posizionate in modo tale che, nell'utilizzo giornaliero del veicolo, non rimangano intrappolate da sedili mobili o nella portiera del veicolo.
- Ricordare che l'utilizzo di altri punti di supporto del peso rispetto a quelli indicati nelle istruzioni potrebbe ridurre notevolmente il fattore di protezione del seggiolino.
- Allacciare sempre la cintura al bambino prima di mettersi in viaggio.

- Non lasciare mai i bambini senza supervisione.
- Non cercare mai di smontare o modificare parti del seggiolino o di sviare dal corretto uso delle cinture di sicurezza del veicolo.
- Dopo un incidente si consiglia di sostituire il seggiolino e le cinture di sicurezza dell'auto. Sebbene non ci siano danni visibili, potrebbero aver perso affidabilità.
- Non mettere cuscini o asciugamani sotto il seggiolino, poiché ciò potrebbe avere influire negativamente la performance del seggiolino durante un incidente.
- Tutte le cinture che legano il seggiolino al sedile dell'auto devono essere ben tirate e non aggrovigliate.
- Assicurarsi sempre che l'imbracatura del seggiolino e la cintura dell'auto siano ben tesi, per garantire la massima protezione per il tuo bambino.
- Assicurarsi che l'imbracatura e la cintura dell'auto non rimangano tra le portiere o sfregino contro parti contundenti.
- Se la cintura o l'imbracatura dovesse logorarsi si consiglia di sostituirle prima di mettersi in viaggio.
- Non sostituire mai le parti del seggiolino con altre non approvate dalla Cosatto.
- La Cosatto consiglia di non comprare o vendere seggiolini in seconda mano. Diversi seggiolini acquistati in questo modo sono risultati pericolosi.
- **ATTENZIONE:** Il seggiolino potrebbe danneggiare il rivestimento dell'auto. La Cosatto non potrà essere ritenuta responsabile di tale danno.
- La sicurezza è garantita solo se il seggiolino viene montato seguendo le istruzioni fornite.
- Legare e assicurare bene qualsiasi bagaglio o altro oggetto che potrebbe ferire il bambino in caso di collisione.
- La mancata osservanza delle istruzioni può essere pericolosa, rende automaticamente nulla la garanzia ed esonera la Cosatto da qualsiasi responsabilità.
- L'ancoraggio della cintura è stato progettato per un facile rilascio in caso di emergenza. **NON È A PROVA DI BAMBINI.** Bambini di natura più curiosa possono imparare a slacciare le cinture. Si consiglia di insegnare ai propri figli di non giocare mai con la fibbia o con qualsiasi altra parte del seggiolino.
- La cintura addominale deve essere posizionata in modo tale da proteggere bene il bacino del bambino.
- Non utilizzare il seggiolino senza la fodera originale, poiché costituisce parte integrante dell'affidabilità dello stesso. Si consiglia di sostituire la fodera solo con altri raccomandati dalla Cosatto.
- Si consiglia di coprire il seggiolino se lasciato sotto il sole per un periodo di tempo prolungato, poiché la superficie potrebbe surriscaldarsi. Si consiglia inoltre di controllare la superficie del seggiolino prima di sistemarvi il bambino.
- **AVVERTENZA:** Per evitare rischio di bruciature, non depositare bevande molto calde sul porta bevande.
- Porta bevande - peso massimo 500g
- La mancata osservanza delle istruzioni può essere pericolosa, rende automaticamente nulla la garanzia ed esonera la Cosatto da qualsiasi responsabilità.

Avvertenza:

1. (100 - 150cm) Questo è un sistema di ritenuta per bambini potenziato per seggiolino i-Size. È approvato secondo il regolamento UN n. 129, per l'uso principalmente in "posti a sedere i-Size" come indicato dai produttori di veicoli nel manuale dell'utente del veicolo.
2. Non utilizzare mai il seggiolino sul sedile del passeggero dotato di airbag attivo.
3. In caso di dubbio, consultare il produttore del seggiolino o il rivenditore.

Manutenzione:

- Questo sistema di ritenuta bambini è stato progettato secondo gli standard di sicurezza e, con un uso corretto e la appropriata manutenzione, vi regalerà diversi anni senza pensieri.
- Conservare il seggiolino in un luogo asciutto e sicuro.
- Riporre un sistema di ritenuta umido incoraggerà la produzione di muffe, si consiglia quindi, dopo l'esposizione ad atmosfere umide, di asciugarlo con un panno soffice e lasciare che si asciughi completamente prima di metterlo via.
- Evitare di lasciare il seggiolino esposto al sole per un periodo prolungato di tempo, poiché i colori potrebbero sbiadire.
- Controllare il seggiolino regolarmente per eventuali danneggiamenti- se presenti, smettere immediatamente di utilizzare il prodotto.
- Non smontare il seggiolino durante la pulizia, non è necessario e potrebbe risultare pericoloso.
- Le parti in plastica e in metallo possono essere pulite con una spugna, acqua tiepida e un detergente delicato.
- Per la pulizia fare riferimento alle istruzioni per il lavaggio dei materiali duttili.
- Rimuovere la fodera/il rivestimento del sedile prima della pulizia.
- Non lavare mai con detersivi abrasivi, a base di ammoniaca, candeggina, o alcool.

Legenda :

	Fare riferimento all'avvertimento XX		Ripetere l'azione x volte		Tenere premuto
	Azione corretta		Freccia per azioni generali		Controllare
	Azione sbagliata		Blocco		Procedere al punto XX
	Segnale acustico		Sblocco		Ripetere l'azione nell'altro lato

Lista delle parti:

Si prega di far riferimento ai diagrammi:

P1: Poggiatesta

P2: Poggiaschiena

P3: Sedile

P4: Braccio ISOFIX

P5: guida ISOFIX (x2)

P6: Scompartimento

P7: Portabibite

Parti di ricambio

Le parti di ricambio disponibili sono elencate qui di seguito. Per il Regno Unito e l'Irlanda è possibile ordinare tramite il nostro sito web: <http://www.cosatto.com/service-centre/spares>
I clienti al di fuori del Regno Unito e dell'Irlanda possono contattare il distributore locale indicato su <http://www.cosatto.com/stockists>

In caso di ulteriore assistenza, non esitate a contattarci all'nostro indirizzo email: cuddle@cosatto.com
S1: Rivestimento in tessuto per poggiatesta S5: Inserto ad ala laterale del poggiatesta (set)
S2: Rivestimento in tessuto per schienale S6: Inserto per schienale (set)
S3: Rivestimento in tessuto della base S7: guida ISOFIX (set)
S4: Inserto centrale del poggiatesta S8: Portabibite

Informazioni per l'uso e il montaggio:

Si prega di fare riferimento ai diagrammi di istruzione

Poggiaschiena 1-

Prima di iniziare:

Collegare la sezione dello schienale alla sezione della base (a) e reclinare lo schienale in posizione verticale (b).

Posizionamento 2-

ATTENZIONE: Non utilizzare mai il seggiolino su un sedile dotato di airbag attivo. Fare riferimento al manuale del veicolo per istruzioni su come disattivare l'airbag.

ATTENZIONE: il seggiolino per bambini può essere installato solo nel senso di marcia, utilizzando una cintura di sicurezza a tre punti e una diagonale sul sedile anteriore o posteriore del passeggero della vettura.

Braccio ISOFIX 3-

Posizionamento:

I due punti di ancoraggio inferiori ISOFIX si trovano solitamente tra la base del sedile e lo schienale (a).
Alcuni veicoli hanno l'indicatore ISOFIX vicino ai punti di ancoraggio inferiore ISOFIX (b).

4- **Montare le guide ISOFIX (Opzionale):**

Le guide ISOFIX possono aiutare a identificare i punti di ancoraggio ISOFIX del veicolo e facilitare l'installazione. Possono anche contribuire a proteggere il sedile del veicolo.

5- **Montaggio:**

Tenere premuti i pulsanti di regolazione del braccio ISOFIX ed estendere completamente i bracci (a).
Agganciare i bracci ISOFIX (b) e assicurarsi che gli indicatori di sicurezza sui bracci ISOFIX siano verdi (c).
Spingere la base all'indietro fino a che non aderisca bene allo schienale del sedile del veicolo (d).
Per rimuovere seguire il processo inverso.

Poggiatesta 6-

Adattamenti:

7- **Posizione corretta del poggiatesta:**

- Cinghie solo con bracci ISOFIX** 8- **Montaggio:**
 Posizionare il seggiolino sul sedile, rivolto in avanti(a).
 Fissare i bracci ISOFIX ai punti di ancoraggio (fare riferimento ai punti 5) (b).
 Fissare il bambino con la cintura del veicolo (fare riferimento al punto 9 - 10) (c).
 Per rimuovere seguire il processo inverso.
- Imbracatura** 9- Posizionare il bambino sul seggiolino.
 Estrarre la cinghia del veicolo fuori e intorno al bambino (a) e fissare la fibbia (b).
 La cintura subaddominale deve essere inserita dentro le guide della cintura subaddominale (c) sotto ai braccioli.
 Far passare la cintura diagonale del veicolo attraverso la guida diagonale del poggiatesta (d).
 10- Tenere ben tesa la cintura (a & d).
ATTENZIONE: La posizione dell'ancoraggio delle cinture può influenzare la stabilità del seggiolino. In caso di incidente potrebbe impedire al seggiolino di proteggere il tuo bambino nel miglior modo possibile. Una volta assicurata la cintura di sicurezza, se la fibbia si trova in posizione X, provare a sistemarla il seggiolino su un altro sedile.
 Per rimuovere seguire il processo inverso.
- Solo con la cintura** 11- **Montaggio:**
 Posizionare il seggiolino sul sedile, rivolto in avanti (a).
 Ritirare i bracci ISOFIX (fare riferimento ai punti 5) (b).
 Fissare il bambino con la cintura del veicolo (fare riferimento al punto 9 - 10) (c).
 Per rimuovere seguire il processo inverso.
- Componenti** 12- **Rimozione:**
 Sollevare il poggiatesta nella posizione più alta (a, fare riferimento al passo 6).
 Allentare la cinghia di regolazione del poggiatesta (b) e i bottoni automatici (c) sul retro del rivestimento in tessuto del poggiatesta.
 Sganciare il rivestimento in tessuto del poggiatesta dalle guide diagonali della cintura di sicurezza del veicolo (d) e rimuovere il rivestimento in tessuto.
 13- Scollegare la sezione dello schienale dalla sezione della base (a).
 Scollegare i passanti elastici dalla sezione dello schienale (b).
 Scollegare le cinghie di fissaggio dalla sezione della base (c).
 Rimuovere il rivestimento in tessuto dello schienale (a) e il rivestimento in tessuto della base (b).
 Per rimontare le parti, seguire le istruzioni al contrario.
- Portabibite** 14- **Montaggio:**

Lista di controllo:

- Avete verificato la compatibilità del seggiolino auto con il veicolo previsto?
- Se applicabile, l'air-bag è disattivato?
- Il seggiolino per bambini è montato correttamente sul sedile del veicolo?
- Avete controllato gli indicatori di sicurezza dei bracci ISOFIX, della gamba di supporto e della sicurezza del sedile ISOFIX?
- Il bambino è correttamente posizionato nel seggiolino auto?
- La cintura e l'imbracatura del veicolo sono adeguatamente tese e non attorcigliate?

- Per le posizioni in altre opzioni di compatibilità, si prega di consultare l'applicazione Cosatto Fit Checker (<http://cosat.to/fitchecker>) o la sezione relativa alla compatibilità del veicolo sul sito web (<http://cosat.to/ninja2isizev1>).
- I numeri riportati nel diagramma del veicolo qui sotto corrispondono alle posizioni dei sedili elencate nella lista di compatibilità del veicolo.

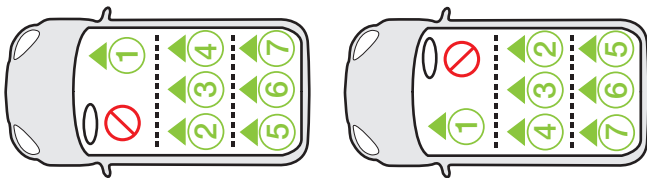

- Se il sistema di ritenuta è compatibile, la posizione adatta è segnata con ●
- Se il sistema di ritenuta non è compatibile, la posizione adatta è segnata con ○
- Veicoli elettrici o ibridi sono segnati con ⚡
- Veicoli i-Size sono segnati con 
- I veicoli con compartimenti sotto il pianale sono contrassegnati con **SB!** - Si prega di consultare il manuale del veicolo prima di montare questo sistema di ritenuta per bambini su questo tipo di veicoli.
- I veicoli la cui altezza del tetto potrebbe impedire l'installazione del sistema di ritenuta rivolto in avanti sono contrassegnati con **!**
- Se il vostro veicolo non è elencato nella lista o non è contrassegnato con un ● o ○, siete pregati di consultare il manuale del veicolo o di contattare la Cosatto o il rivenditore per ulteriori informazioni.
- Anche i posti a sedere di altri veicoli possono essere adatti ad accogliere il sistema di ritenuta bambini. In caso di dubbio, consultare la Cosatto o il rivenditore.



Prima di acquistare il veicolo, verificare che sia dotato degli ancoraggi appropriati.

Dare SEMPRE la priorità ai sedili posteriori del veicolo.



NON montare il sistema di ritenuta bambini su un sedile dotato di airbag, a meno che questo non possa essere disattivato. Morte o gravi lesioni possono essere causate da un AIRBAG attivato.

- L'elenco di compatibilità del veicolo è stato preparato accuratamente utilizzando dati scientifici raccolti sia dal veicolo che dal sistema di ritenuta bambini. La Cosatto non si assume alcuna responsabilità per eventuali inesattezze della lista, che ha solo scopo orientativo.
- Si consiglia di verificare che il sistema di ritenuta bambini sia compatibile con il veicolo al momento dell'acquisto.

Importante: Guarde estas instruções para futura referência.

Informação Importante de segurança.

O manual de instruções deverá ser mantido em segurança com o assento de carró para criança durante o seu período de vida:

Existe um compartimento ao lado da cadeira auto para guardar o manual de instruções.

Recomenda-se que verifique no momento da compra se a retenção infantil é compatível com o veículo pretendido.

Por favor consulte a lista de veículos, a app de verificação de instalação da Cosatto (<http://cosat.to/fitchecker>) ou a secção da lista de montagem do veículo no site (<http://cosat.to/ninja2isizev1>).

As posições dos assentos noutros veículos também podem ser adequadas para aceitar a retenção infantil. Em caso de dúvida, consulte a Cosatto ou o revendedor.

Peso e altura da criança:

- O assento do carro é adequado para alturas entre 100 e 150 cm, até um peso máximo de 36 kg.
- **IMPORTANTE - SÓ UTILIZAR VIRADO PARA A FRENTE QUANDO A CRIANÇA COMPLETAR OS 15 MESES.**

Localização:

- Consulte a lista de veículos para informação sobre onde a base do assento de carro para criança poderá ser instalada no seu veículo.
- Nunca utilize o assento de carro para criança num assento onde esteja um airbag instalado e ativo. Consulte o manual de utilizador do seu veículo para informações sobre como desativar o airbag.
- Se o encosto de costas do assento do veículo tiver uma função de inclinação, coloque o assento do veículo na posição mais reta possível quando utiliza o assento de carro para criança.
- NÃO use o assento de carro para criança em casa. Não foi concebido para ser usado em casa e só deve ser utilizado no seu carro.

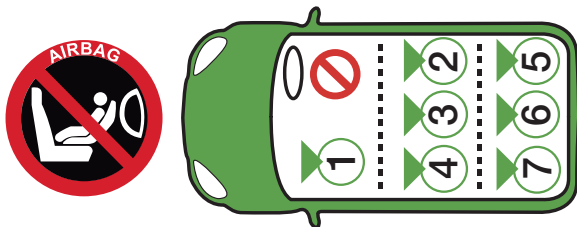

Segurança - Por favor leia com cuidado:

- **NUNCA** use este assento de carro para criança voltado para o assento do carro.
- Devem ser localizados e instalados quaisquer elementos rígidos ou partes plásticas do assento de carro para criança no veículo caso não se encontrem em conformidade, para que não fiquem entalados num assento móvel ou porta de veículo.
- Se o peso do carregamento for superior ao descrito nas instruções, isto pode reduzir significativamente o fator de proteção do Assento de carro para criança.
- Feche **SEMPRE** o arrieio de segurança da sua criança quando utilizar este assento de carro para criança.
- **NUNCA** deixe a sua criança sem supervisão.
- **NÃO** tente desmontar, modificar ou adicionar nenhuma parte do sistema de retenção de criança ou modificar a forma pela qual os cintos do seu carro são feitos ou utilizados.
- Após um acidente o sistema de retenção de criança deve ser substituído assim como os cintos de segurança do assento do veículo. Embora possam não parecer danificados, podem não proteger a sua criança tão bem como poderiam.
- Não coloque nada como toalhas ou almofadas sob o assento de carro para criança. Isto poderá afetar o desempenho do assento de carro para criança em caso de acidente.
- Qualquer cinto de veículo contendo o sistema de retenção de criança ao veículo deve permanecer apertado, e esse cinto não deve estar torcido.
- Certifique-se sempre de que o arrieio do assento de carro para criança e cinto do veículo se encontram corretamente sob tensão para assegurar a máxima proteção à sua criança.
- Evite que o arrieio/cinto do veículo fique entalado nas portas dos carros ou que rocem contra partes aguçadas do assento ou corpo.
- Se o cinto/cinto do veículo ficar cortado ou desgastado, troque-o antes de viajar.
- Nunca use outras peças que não sejam aprovadas pela Cosatto.
- A Cosatto aconselha que o assento de carro para criança não deve ser comprado ou vendido em segunda mão. Muitos assentos de carro para criança adquiridos desta forma demonstraram ser perigosos.
- **NOTA:** O assento de carro para criança pode marcar o estofado do assento do veículo. A Cosatto não pode ser responsabilizada por danos ou marcas no estofado do assento do veículo.
- A segurança só é garantida se o assento de carro para criança for instalado em conformidade com estas instruções.
- Prenda seguramente qualquer bagagem ou quaisquer outros objetos que possam ferir o ocupante do assento de carro para criança na eventualidade de uma colisão.
- O não cumprimento das instruções pode ser perigoso e anula automaticamente a garantia e isenta a Cosatto de qualquer responsabilidade.
- O fecho do arrieio foi concebido para ser rapidamente desengatado no caso de uma emergência. **NÃO É À PROVA DE CRIANÇA.** As crianças mais curiosas podem aprender a abrir o fecho. Deve-se aconselhar as crianças a nunca brincarem com o fecho do arrieio ou qualquer outra parte do assento de carro para criança.
- A tranca do cinto do assento do veículo deve ser utilizada de uma forma que mantenha a pélvis da criança segura.
- É importante que a tranca do arrieio fique justa, para que a pélvis da criança fique firme e segura.
- Nunca use o assento de carro para criança sem a sua cobertura de tecido pois a cobertura de tecido constitui uma parte integral do desempenho do assento de carro para criança. A cobertura de tecido não deve ser substituída por nenhuma outra que não seja recomendada pela Cosatto.
- Cubra o assento de carro para criança se este se encontrar sob a luz direta do sol por períodos prolongados, pois as superfícies da base do assento de carro para criança podem ficar muito quentes. Verifique a superfície do assento de carro para criança antes de colocar a sua criança no assento.

- **AVISO:** Para evitar riscos de queimaduras, não coloque bebidas quentes no suporte para bebidas.
- Suporte para bebida - peso máximo de 500 gr.
- O não cumprimento das instruções pode ser perigoso e anula automaticamente a garantia e isenta a Cosatto de qualquer responsabilidade.

Nota:

1. (100 - 150cm) Este é um assento elevatório i-Size com sistema avançado de retenção para crianças. É aprovado de acordo com o Regulamento da ONU nº 129, para uso principalmente em "assentos i-Size", conforme indicado pelos fabricantes de veículos no manual do usuário.
2. Nunca use este assento de carro para criança no assento do passageiro que esteja equipado com um airbag ativo instalado.
3. Em caso de dúvida, consulte também o fabricante ou vendedor do sistema de retenção para criança.

Tratamento e Manutenção:

- O seu sistema de retenção de criança foi concebido para ir de encontro aos padrões de segurança e utilização e manutenção corretas que lhe oferecerão muitos anos de desempenho sem problemas.
- Guarde o seu sistema de retenção de criança num local seco e seguro.
- Ao guardar um sistema de retenção de criança húmido isto irá originar a formação de mofo, por isso, após a exposição a condições húmidas, seque-o com um pano suave ou deixe secar antes de guardar.
- Evite deixar o sistema de retenção de criança à luz do sol por períodos prolongados pois isto pode causar descoloração dos tecidos.
- Inspeção regularmente se o sistema de retenção de criança contém sinais de danos- pare de utilizar o produto se encontrar danos.
- **NÃO** desmonte ou tente desmontar o sistema de retenção de criança quando limpa. É desnecessário e perigoso fazer isto.
- As partes plásticas e metálicas podem ser limpas com uma esponja embebida em água morna e detergente neutro.
- Consultar cuidados de lavagem em materiais suaves para instruções de limpeza.
- Remova o revestimento/ redutor da cadeira antes de a limpar.
- Nunca limpar com produtos abrasivos, à base de amónia, lixívia ou álcool.

Chave de linguagem visual:

	Consultar aviso XX		Repetir a ação x vezes		Pressionar e manter
	Ação correta		Seta de ação geral		Verificar
	Ação incorreta		Bloquear		Continuar para passo XX
	Som audível		Desbloquear		Repetir no outro lado

Lista de Peças:

Por favor, consulte os diagramas:

P1: Descanso para cabeça

P2: Encosto para cabeça

P3: Assento

P4: Braço ISOFIX

P5: Guia ISOFIX (x2)

P6: Compartimento de armazenamento

P7: Suporte para bebidas

Peças de Substituição:

As peças de substituição mostradas abaixo encontram-se disponíveis para o seu produto.

Para os clientes do Reino Unido e Irlanda, encomendas através do nosso website:

<http://www.cosatto.com/service-centre/spares>

Para os clientes do Reino Unido e Irlanda, a informação de contacto para o seu distribuidor local encontra-se em <http://www.cosatto.com/stockists>

Se precisar de mais assistência, queira contactar-nos através do cuddle@cosatto.com

S1: Cobertura de tecido do encosto da cabeça

S5: Inserção na aba lateral do encosto da cabeça

S2: Cobertura de tecido do encosto de costas

S6: Inserção no encosto de costas (conjunto)

S3: Cobertura de tecido da base

S7: Guia ISOFIX (conjunto)

S4: Inserção no centro do encosto da cabeça

S8: Suporte para bebidas

Informação de ajuste e operação:

Por favor, consulte os diagramas de instruções:

Encosto para cabeça

1-

Preparação:

Ligue a secção do encosto de costas à secção da base (a) e incline o encosto de costas para a posição vertical (b).

Localização

2-

IMPORTANTE: Nunca use o assento de carro para criança num assento de veículo onde esteja equipado e ativado um airbag. Consulte o manual de utilizador do seu veículo para informações sobre como desativar o airbag.

AVISO: O seu assento de carro para criança só pode ser instalado voltado para a frente, usando uma tranca de três pontos e o cinto diagonal do veículo nos assentos do passageiro à frente ou atrás do carro.

Braço ISOFIX

3-

Localização:

Os dois pontos de ancoragem baixos ISOFIX para a ancoragem baixa geralmente estão situados entre a base do assento do veículo e a parte traseira (a).

Alguns veículos têm indicador ISOFIX perto dos pontos de ancoragem ISOFIX para a ancoragem baixa (b).

4-

Ajuste das guias ISOFIX (Opcional):

As guias ISOFIX podem ajudar a identificar os pontos de ancoragem ISOFIX do veículo, tornando mais fácil a instalação. Os mesmos podem também ajudar a proteger o banco do seu veículo.

- 5- Instalação:**
 Pressione e mantenha pressionados os botões ISOFIX para o ajuste dos braços e estenda os braços completamente (a). Engate os braços do ISOFIX (b) e assegure-se que os indicadores de segurança do braço ISOFIX se encontram verdes (c). Empurre a base para trás até que esta fique firmemente encostada contra o encosto do banco do veículo (d). A remoção faz-se do modo inverso a este procedimento.
- Descanso para cabeça** 6- **Ajuste:**
 7- **Posição satisfatória do apoio de cabeça:**
- Cintado apenas com braços ISOFIX** 8- **Instalação:**
 Posição do assento de carro para criança no assento do veículo, virado para a frente(a).
 Prenda os braços ISOFIX aos pontos de ancoragem (consulte o passo 5) (b).
 Prenda seu filho com o cinto do veículo (consulte o passo 9 - 10) (c).
 A remoção faz-se do modo inverso a este procedimento.
- Cinto** 9- Sente o seu filho no assento de carro para criança.
 Puxe para fora o cinto do veículo, coloque-o à volta da criança (a) e aperte a o fecho (b).
 A tranca do cinto de assento de veículo deve ficar bloqueada com as guias do cinto de assento de veículo (c) sob os encostos de braços. Ajuste o cinto diagonal do veículo através da guia do cinto diagonal do veículo para o apoio para a cabeça (d).
- 10- Crie tensão no cinto do veículo (a & b).
IMPORTANTE: A posição da fivela do cinto do veículo pode afetar a estabilidade do sistema de retenção de criança. Num acidente isto poderá evitar que o sistema de retenção de criança proteja a sua criança tão bem como seria suposto. Após apertar o cinto do veículo, se a fivela permanecer na posição marcada (X) então tente ajustar o sistema de retenção de criança numa outra posição no seu veículo.
 A remoção faz-se do modo inverso a este procedimento.
- Apenas com cinto** 11- **Instalação:**
 Posição do assento de carro para criança no assento do veículo, virado para a frente (a).
 Retraia os braços ISOFIX (consulte o passo 5) (b).
 Prenda seu filho com o cinto do veículo (consulte o passo 9 - 10) (c).
 A remoção faz-se do modo inverso a este procedimento.
- Almofadados** 12- **Remoção:**
 Levante o encosto de cabeça para a sua posição mais alta (a, consulte o passo 6).
 Desaperte a alça de ajuste do encosto de cabeça (b) e botões (c) na parte de trás da cobertura de tecido do encosto de cabeça. Solte a cobertura de tecido do encosto de cabeça a partir das guias dos cintos de segurança (d) e remova a cobertura de tecido.

- 13- Separe a secção do encosto de costas da secção da base (a).
Separe os ganchos elásticos na secção do encosto de costas (b).
Separe as alças de retenção da secção da base (c).
Remova a cobertura de tecido do encosto de costas (a) e a
cobertura de tecido da base (b).
Faça o inverso do procedimento acima descrito para voltar a
colocar os almofadados

**Suporte
para
bebidas**

- 14- **Instalação:**

Lista de verificação:

- Verificou a compatibilidade do assento de carro para crianças com o veículo pretendido?
- Quando aplicável o air-bag está desativado?
- O seu assento de carro para crianças está corretamente montado ao veículo?
- Verificou os indicadores de segurança nos braços ISOFIX, na perna de suporte ISOFIX e na segurança do assento?
- A sua criança está corretamente presa no assento de carro para crianças?
- O arreo está adequadamente tensionado e não está torcido?

- Para posições de assento com outras opções de instalação, consulte a app Cosatto verificadora de instalação (<http://cosat.to/fitchecker>) ou a secção da lista de montagem do veículo no site (<http://cosat.to/ninja2isizevl>).
- Os números no diagrama do veículo abaixo correspondem às posições do assento referidas na lista de montagem do veículo.

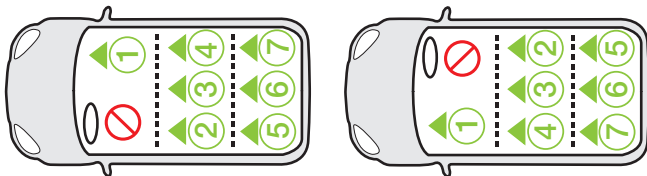

- Se a retenção infantil puder ser instalada a (s) posição/posições adequada (s) do assento está/estão marcada (s) com ●
- Se a retenção infantil não puder ser instalada, a (s) posição/posições adequada (s) do assento está/estão marcadas com ○
- Os veículos elétricos ou híbridos estão marcados com ⚡
- Os veículos i-Size estão marcados com
- Os veículos com compartimento (s) de armazenamento no nível inferior estão marcados com **SB!** - Por favor consulte o manual do veículo antes de instalar esta retenção infantil nesses veículos.
- Os veículos com uma altura de tejadilho de cabine que possam limitar a retenção da criança de ser instalada voltada para a frente, são marcados com !
- Caso o seu veículo não se encontre mencionado nesta lista ou não esteja marcado com um ● ou ○, consulte o manual do veículo ou entre em contacto com a Cosatto ou com o seu revendedor, para obter mais informações.
- As posições dos assentos noutros veículos também podem ser adequadas para aceitar a retenção infantil. Em caso de dúvida, consulte a Cosatto ou o revendedor.



Antes de comprar o veículo, verifique se o mesmo está equipado com as ancoragens apropriadas.

Dê SEMPRE prioridade aos assentos traseiros do veículo.



NÃO coloque o sistema de retenção infantil num assento de veículo equipado com um airbag, a menos que o mesmo possa ser, e seja, desativado. A morte ou lesões graves podem ser provocadas por um sistema de AIRBAG ativado.

- Esta lista de montagem do veículo foi cuidadosamente preparada com recurso a dados científicos recolhidos tanto sobre o veículo como sobre a retenção infantil. A Cosatto não aceita qualquer responsabilidade em relação a quaisquer imprecisões da lista, a qual se destina apenas a fins de orientação.
- Recomenda-se que verifique no momento da compra se a retenção infantil é compatível com o veículo pretendido.

Важно! Сохраняйте эту инструкцию для последующего использования.

Важная информация по технике безопасности.

Эту инструкцию по эксплуатации следует бережно хранить с детским автокреслом в течение всего срока его использования:

Сбоку детского автокресла есть отделение для хранения инструкции по эксплуатации. При покупке рекомендуется удостовериться в совместимости детского удерживающего устройства с конкретным автомобилем.

См. список моделей, приложение Cosatto для проверки совместимости (<http://cosat.to/fitchecker>) или список совместимых моделей автомобилей на веб-сайте (<http://cosat.to/ninja2isizev1>).

Положения установки в других автомобилях, возможно, тоже подходят для установки детского удерживающего устройства. Если сомневаетесь, проконсультируйтесь с сотрудниками компании Cosatto или продавцом.

Рост и вес ребенка:

- Автокресло подходит для роста от 100 до 150 см и весе не более 36 кг.
- **ВАЖНО! ЗАПРЕЩАЕТСЯ ИСПОЛЬЗОВАТЬ АВТОКРЕСЛО ЛИЦОМ ПО ХОДУ ДВИЖЕНИЯ ДО ДОСТИЖЕНИЯ РЕБЕНКОМ 15- МЕСЯЧНОГО ВОЗРАСТА.**

Расположение:

- Чтобы правильно выбрать место установки основания детского автокресла в автомобиле, см. список моделей. безопасности на переднем или заднем сиденье автомобиля.
- Категорически запрещается устанавливать детское автокресло на сиденье с включенной подушкой безопасности. Для отключения подушки безопасности обратитесь к руководству по эксплуатации вашего автомобиля.
- Если наклон спинки сиденья можно регулировать, перед установкой детского автокресла поднимите спинку сиденья в крайнее верхнее положение.
- **ЗАПРЕЩАЕТСЯ** использовать детское автокресло у себя дома. Детское кресло не предназначено для эксплуатации в домашних условиях и должно использоваться только в автомобиле.

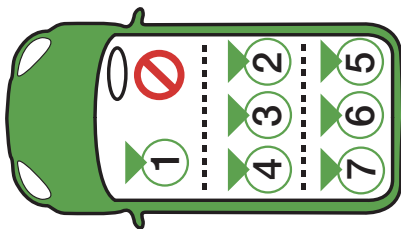

Безопасность – прочтите внимательно:

- **КАТЕГОРИЧЕСКИ ЗАПРЕЩАЕТСЯ** устанавливать это детское автокресло перпендикулярно ходу движения.
- Любые жесткие элементы и пластиковые детали детского автокресла следует всегда располагать и устанавливать таким образом, чтобы их не зажало при регулировке сиденья или закрытии дверцы автомобиля.

- Использование точек нагружения, не предусмотренных этой инструкцией, может значительно снизить уровень безопасности детского автокресла.
- **ОБЯЗАТЕЛЬНО** пристегивайте ребенка удерживающими ремнями при перевозке в детском автокресле.
- **КАТЕГОРИЧЕСКИ ЗАПРЕЩАЕТСЯ** оставлять ребенка без присмотра.
- **ЗАПРЕЩАЕТСЯ** разбирать детское удерживающее устройство и вносить изменения в его конструкцию, добавлять что-либо, а также изменять способ крепления или использования штатных ремней безопасности вашего автомобиля.
- После ДТП следует заменить детское удерживающее устройство и штатные ремни безопасности автомобиля. Даже при отсутствии видимых повреждений они уже не могут обеспечить необходимый уровень безопасности вашего ребенка.
- Запрещается размещать что-либо под детским автокреслом (полотенце, подушку и т.д.). Это может снизить эффективность детского автокресла в случае ДТП.
- Ремень безопасности, фиксирующий детское удерживающее устройство, должен быть плотно натянут и не перекручен.
- Обязательно убедитесь, что удерживающие ремни детского автокресла и штатный ремень безопасности натянуты правильно. Это необходимо для обеспечения максимального уровня защиты вашего ребенка.
- Следите, чтобы удерживающие ремни/штатный ремень безопасности не зажали дверцы автомобиля, а также чтобы они не перетирались об острые выступы на сиденье или кузове.
- В случае надрывов или потертостей на удерживающих ремнях/штатном ремне безопасности замените их перед поездкой.
- Категорически запрещается использовать запасные части сторонних производителей.
- Компания Cosatto не рекомендует приобретать или продавать бывшие в употреблении детские автокресла. Использование подержанных детских автокресел нередко бывает опасным.
- **ПРИМЕЧАНИЕ:** Детское автокресло может оставлять следы на сиденье автомобиля. Компания Cosatto не несет ответственность за повреждение сиденья автомобиля или следы на нем.
- Компания гарантирует надлежащий уровень безопасности только в том случае, если детское автокресло установлено в соответствии с этой инструкцией.
- Надежно закрепите любой багаж и все предметы, которые в случае столкновения могут упасть и травмировать ребенка, сидящего в детском автокресле.
- Несоблюдение указаний и мер предосторожности сопряжено с опасностью. В этом случае гарантия автоматически аннулируется, а компания Cosatto освобождается от всякой ответственности.
- Конструкция пряжки позволяет быстро отстегивать удерживающие ремни в экстренных случаях. **ЗАЩИТА ОТ ДЕТЕЙ НЕ ПРЕДУСМОТРЕНА.** Любопытный ребенок быстро поймет, как отстегнуть пряжку. Следует предупредить детей о том, что они ни в коем случае не должны играть с пряжкой удерживающих ремней или любой другой деталью детского автокресла.
- Нижняя часть штатного ремня безопасности должна надежно фиксировать таз ребенка.
- Запрещается использовать детское автокресло без чехла, поскольку чехол тоже влияет на эффективность удерживающего устройства. В случае замены чехла следует использовать только чехлы, рекомендованные компанией Cosatto.
- Укрывайте детское автокресло от прямых солнечных лучей. Если надолго оставить его на солнце, основание автокресла может сильно нагреться. Перед тем как сажать ребенка в автокресло, убедитесь, что это безопасно.

- **ВНИМАНИЕ!** Чтобы исключить риск ожога, запрещается ставить горячие напитки в держатель для бутылочки.
- держатель для бутылочки – максимальный вес 500 г.
- Несоблюдение указаний и мер предосторожности сопряжено с опасностью. В этом случае гарантия автоматически аннулируется, а компания Cosatto освобождается от всякой ответственности.

Предупреждение:

1. (100 - 105cm) Это сиденье-бустер с усовершенствованной детской удерживающей системой размера i.
Он одобрен в соответствии с Правилами № 129 ООН для использования в основном на "сиденьях размера i", как указано изготовителями транспортных средств в руководстве по эксплуатации транспортного средства.
2. Категорически запрещается устанавливать это детское автокресло на пассажирском сиденье с включенной подушкой безопасности.
3. Если сомневаетесь, проконсультируйтесь с изготовителем или продавцом детского удерживающего устройства.

Уход и обслуживание:

- Это детское удерживающее устройство полностью соответствует нормам безопасности. При правильном использовании и уходе оно прослужит долгие годы.
- Детское удерживающее устройство следует хранить в сухом и надежном месте.
- На влажном детском удерживающем устройстве может образоваться плесень. Поэтому его следует предварительно протереть сухой мягкой тканью и тщательно высушить.
- Не оставляйте надолго детское удерживающее устройство на солнце во избежание выгорания тканевого чехла.
- Регулярно проверяйте состояние детского удерживающего устройства. Если вы обнаружили повреждение, не пользуйтесь им.
- **ЗАПРЕЩАЕТСЯ** разбирать или пытаться разобрать детское удерживающее устройство при чистке. Это не нужно и небезопасно.
- Пластиковые и металлические детали легко отчищаются губкой, смоченной мягким моющим средством.
- Производите чистку в соответствии с рекомендациями для текстиля.
- Выньте вставку из чехла / вкладыша сиденья перед чисткой.
- Запрещается использовать абразивные чистящие средства, средства на основе аммиака и растворителя, а также отбеливатели.

Условные обозначения:

	См. меры предосторожности XX		Повторить действие x раз		Нажать и удерживать
	Правильно		Указывает на действие общего характера		Проверить
	Неправильно		Зафиксировать		Продолжить с шага XX
	Слышен звук		Разблокировать		Повторить с другой стороны

Перечень запасных частей:

См. схемы:

P1: Подголовник

P2: Спинка

P3: Сиденье

P4: Кронштейн ISOFIX

P5: Кронштейн ISOFIX (x2)

P6: Отсек для хранения

P7: Держатель для бутылочки

Запасные части:

Ниже указаны запасные части, которые вы можете приобрести для этого устройства. Если вы находитесь в Великобритании или в Ирландии, сделайте заказ через наш веб-сайт <http://www.cosatto.com/service-centre/spares>

Если вы находитесь за пределами Великобритании или Ирландии, обратитесь к вашему местному дистрибьютору. Контактные данные дистрибьютора доступны по адресу <http://www.cosatto.com/stockists>

Если у вас остались вопросы, напишите нам на адрес cuddle@cosatto.com

S1: Тканевый чехол подголовника

S5: Боковые вставки подголовника (комплект)

S2: Тканевый чехол спинки

S6: Вставка спинки (комплект)

S3: Тканевый чехол основания

S7: Кронштейн ISOFIX (комплект)

S4: Центральная вставка подголовника

S8: Держатель для бутылочки

Информация по установке и использованию:

См. следующие схемы к инструкции:

Спинка

1-

Подготовка:

Соедините спинку с основанием (а) и переведите спинку в вертикальное положение (b).

Расположение

2-

ВАЖНО! Категорически запрещается устанавливать детское автокресло на сиденье с включенной подушкой безопасности. Для отключения подушки безопасности обратитесь к руководству по эксплуатации вашего автомобиля.

ПРЕДУПРЕЖДЕНИЕ! Установка детского автокресла допускается только лицом по ходу движения. При этом автокресло надежно фиксируется трехточечным ремнем и плечевой частью штатного ремня безопасности на переднем или заднем сиденье автомобиля.

- Кронштейн ISOFIX** 3- **Расположение:**
 Две нижние точки крепления ISOFIX обычно расположены между основанием и спинкой сиденья автомобиля (а). В некоторых автомобилях рядом с местом расположения нижних точек крепления ISOFIX имеется соответствующий указатель (b).
- 4- **Установка кронштейна ISOFIX (Не обязательно):**
 Направляющие ISOFIX помогают определить место расположения точек крепления ISOFIX в автомобиле и упрощают установку. Они также позволяют лучше защитить сиденье автомобиля.
- 5- **Установка:**
 Нажав кнопки регулировки кронштейна ISOFIX и удерживая их в этом положении, полностью вытяните кронштейны (а). Вставьте рычаги ISOFIX (b) и убедитесь, что индикаторы безопасности рычагов ISOFIX зеленого цвета (с). Подайте основание назад, чтобы оно плотно прилегало к спинке сиденья автомобиля (d). Для снятия выполните указанные действия в обратном порядке.
- Подголовник** 6- **Регулировка:**
 7- **Правильное положение подголовника:**
- Вариант со штатным ремнем безопасности и кронштейнами ISOFIX** 8- **Установка:**
 Установите детское автокресло на сиденье автомобиля лицом по ходу движения (а).
 Зафиксируйте кронштейны ISOFIX в точках крепления (см. шаги 5) (b).
 Закрепите ребенка ремня безопасности (см. шаги 9 - 10) (с).
 Для снятия выполните указанные действия в обратном порядке.
- Удерживающие ремни** 9- Усадите ребенка в детское автокресло.
 Вытяните штатный ремень безопасности, правильно расположите его на теле ребенка (а) и застегните пряжку (b). Нижняя часть штатного ремня безопасности должна быть протянута через направляющие нижней части штатного ремня безопасности (с) под подлокотниками.
 Пропустите плечевую часть штатного ремня безопасности через соответствующую направляющую, расположенную на подголовнике (d).
- 10- Подтяните плечевую часть ремня безопасности (а и b).
ВАЖНО! Положение пряжки штатного ремня безопасности может влиять на стабильность детского удерживающего устройства. Неправильное положение пряжки может значительно снизить уровень безопасности детского удерживающего устройства в случае ДТП. Если после подтяжки штатного ремня безопасности пряжка находится в положении (X), установите детское удерживающее устройство на другое сиденье вашего автомобиля.
 Для снятия выполните указанные действия в обратном порядке.

- Перевод в режим бустера** 11- **Установка:**
 Установите детское автокресло на сиденье автомобиля лицом по ходу движения (а).
 Втяните рычаги ISOFIX (см. Шаг 5) (b).
 Закрепите ребенка ремня безопасности (см. шаги 9 - 10) (c).
 Для снятия выполните указанные действия в обратном порядке.
- Мягкой фурнитуры** 12- **Снятие:**
 Установите подголовник в самое верхнее положение (а, см. шаг б).
 Расстегните ремень натяжителя подголовника (b) и кнопки (c) с задней стороны тканевого чехла подголовника.
 Отсоедините тканевый чехол подголовника от направляющих плечевой части ремня безопасности, расположенных на подголовнике, (d) и снимите тканевый чехол.
- 13-
 Отсоедините спинку от основания (а).
 Снимите эластичные петли со спинки (b).
 Снимите фиксирующие ремешки с основания (а).
 Снимите тканевый чехол спинки (а) и тканевый чехол основания (b).
 Чтобы установить мягкую фурнитуру на автокресло, выполните указанные действия в обратном порядке.
- Держатель для бутылочки** 14- **Установка:**

Контрольный список:

- Вы проверили совместимость детского автокресла с конкретным автомобилем?
- Отключена ли подушка безопасности (если применимо)?
- Правильно ли установлено детское автокресло на сиденье автомобиля?
- Вы проверили индикаторы безопасности на кронштейнах ISOFIX, опорную стойку ISOFIX, а также безопасность автокресла?
- Правильно ли зафиксирован ребенок в детском автокресле?
- Достаточно ли туго натянуты удерживающие ремни? Не перекручены ли они?

- Сведения о других положениях / вариантах установки см. в приложении Cosatto для проверки совместимости (<http://cosat.to/fitchecker>) или в списке совместимых моделей автомобилей на веб-сайте (<http://cosat.to/ninja2isizevl>).
- Цифры на приведенной ниже схеме автомобиля соответствуют положениям установки, указанным в списке совместимых моделей автомобилей.

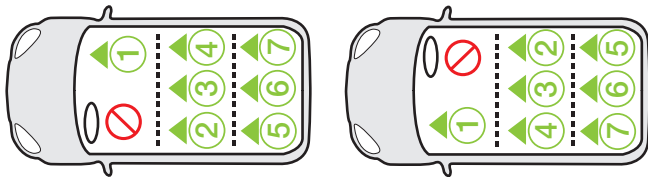

- Если установить детское удерживающее устройство можно, нужные положения установки отмечены значком ●
- Если установить детское удерживающее устройство нельзя, нужные положения установки отмечены значком ○
- Электромобили или автомобили с гибридным приводом отмечены значком ⚡
- Автомобили i-Size отмечены значком
- Автомобили с отсеком(ами) для хранения под полом отмечены значком **SB!** - Внимательно ознакомьтесь с руководством по эксплуатации автомобиля, прежде чем устанавливать это детское удерживающее устройство в данный тип автомобилей.
- Автомобили, высота салона которых, вероятно, не позволяет устанавливать детское удерживающее устройство лицом по ходу движения, отмечены значком !
- Если ваш автомобиль не указан в этом списке, либо не отмечен значком ● или ○, смотрите руководство по эксплуатации автомобиля или свяжитесь для получения более подробной информации с компанией Cosatto / продавцом.
- Положения установки в других автомобилях, возможно, тоже подходят для установки детского удерживающего устройства. Если сомневаетесь, проконсультируйтесь с сотрудниками компании Cosatto или продавцом.



Перед покупкой автомобиля удостоверьтесь, что он оборудован соответствующими точками крепления.

ВСЕГДА отдавайте предпочтение установке на заднем сиденье автомобиля.

ЗАПРЕЩАЕТСЯ устанавливать детское удерживающее устройство на сиденье автомобиля, оборудованном подушкой безопасности. Установка возможна только в том случае, если подушка безопасности отключена. Срабатывание подушки безопасности может привести к гибели или тяжелым травмам.

- Этот список совместимых моделей автомобилей был подготовлен с использованием научных данных как об автомобилях, так и о детском удерживающем устройстве. Компания Cosatto не несет никакой ответственности за любые неточности в этом списке, который предоставляется исключительно для сведения.
- При покупке рекомендуется удостовериться в совместимости детского удерживающего устройства с конкретным автомобилем.

重要提示：请保留此说明以供未来参考。

重要安全信息。

这份说明手册应当在儿童安全座椅整个使用寿命期内安全保管：

儿童汽车安全座椅的侧面有一个隔层，用于存放使用说明书。

建议在购买时检查儿童约束系统与计划安装该系统的车辆之间是否兼容。

请参阅车辆清单、Cosatto 兼容性检查工具 (<http://cosat.to/fitchecker>) 或网站上的车辆安装清单 (<http://cosat.to/ninja2isizevl>)。

其它车辆中的座椅位置也可能适合安装儿童约束系统。如有疑问，请咨询 Cosatto 或零售商。

小孩的身高和体重：

- 本安全座椅适用于身高在 100 至 150 厘米之间，最大体重不超过 36 公斤的儿童。
- **重要：在儿童不超过15个月前，切勿采用前向安装。**

位置：

- 如需获取儿童安全座椅底座在您车辆上的安装位置信息，请参考车辆清单。
- 切勿在装有活动安全气囊的座位上使用这种儿童安全座椅。如需获取解除安全气囊活动状态的信息，请参考您的车辆用户手册。
- 如果车辆座椅的椅背具有倾斜功能，请在使用儿童安全座椅时将车辆座椅置于最直立的位置。
- 请勿在家里使用儿童安全座椅。它并非为住家使用而设计，应当仅用于汽车内。

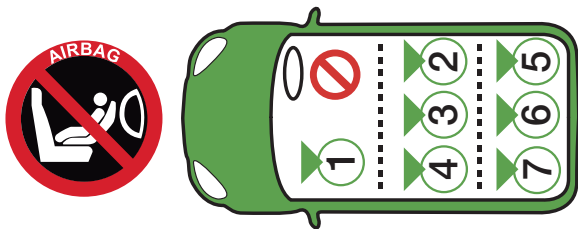

安全 - 请仔细阅读：

- 切勿在使用这种儿童安全座椅时使其侧面朝向汽车座椅。
- 儿童安全座椅的任何硬体部分和塑料部件必须妥当放置，因此在车辆的日常使用中，它们不会导致被可移动座椅困在车门内。
- 如果利用说明手册所描述以外的任何承重点，这可严重降低儿童安全座椅的保护系数。
- 始终在使用这种儿童安全座椅时给您的孩子系上安全带。
- 请勿允许儿童独自留守汽车。
- 请勿试图拆除、改装或增加儿童约束系统的任何部件，或者改变您车辆安全带的制作或使用方式。
- 发生事故后应当更换儿童约束系统及车辆安全带。尽管看起

来完好无损，它们可能达不到对您孩子应有的保护性能。

- 请勿将诸如毛巾或垫子之类的任何东西放置在儿童安全座椅下面。这会影儿童安全座椅在事故中的性能。
- 任何将儿童约束系统绑定在汽车上的汽车安全带应当系紧，且该安全带不得卷曲。
- 始终确保儿童安全座椅安全带和车辆安全带的松紧适中，从而确保对您孩子的最大保护。
- 谨防安全带/车辆安全带被车门卡住或用座椅或身体的锐利部分摩擦
- 如果安全带/车辆安全带出现裂缝或磨损，请在旅行前更换掉。
- 切勿使用经 Cosatto 认准以外的替换部件。
- Cosatto 建议不要对儿童安全座椅进行二手购买或转售。我们发现通过这种方式获取的许多儿童安全座椅存在危险。
- 注意：这种儿童安全座椅可在车辆座椅垫衬物上留下痕迹。Cosatto 对于车辆座椅垫衬物的损坏或刮痕恕不负责。
- 只有按照这些说明安装儿童安全座椅才能保证其安全。
- 安全放置任何可能在碰撞事故中造成儿童安全座椅使用者受伤的行李或其它物品。
- 如不遵守这些指示将会带来危险，并将自动取消质保和免除 Cosatto 承担任何责任。
- 安全带锁扣已被设计成在紧急状况时可快速解开。它不能防止儿童误操作。好奇心更大的儿童可能学会解开锁扣。应当教会儿童切勿拿安全带锁扣或儿童安全座椅的任何部分来玩耍。
- 使用车辆座椅安全腰带时必须尽量靠下，从而恰当地保护儿童骨盆的安全。
- 切勿在使用儿童安全座椅时取掉其布套，因为布套构成儿童安全座椅性能的整体部分。布套不应更换为 Cosatto 所推荐以外的产品。
- 遮盖儿童安全座椅如果它被长期置于阳光直射之下，以免儿童安全座椅底座表面变得过热。将儿童置入座椅之前检查儿童安全座椅的表面。
- **警告：**为避免烫伤不要将热饮料放在饮料架上。
- 饮料架 - 最大重量为500克。
- 如不遵守这些指示将会带来危险，并将自动取消质保和免除 Cosatto 承担任何责任。

注意:

1. (100至150厘米) 本产品是 i-Size 加高座椅增强型儿童约束系统。它根据联合国第 129 号条例获得批准, 主要用于车辆制造商在车辆用户手册中指定的“i-Size 座椅位置”。
2. 不能在配备有安全气囊的座位上使用儿童安全座椅。
3. 如有疑问, 请咨询该儿童约束装置的制造商或零售商。

保养与维护:

- 您的儿童约束系统的设计是为了满足安全标准, 正确的使用和保养会给多年无故障的性能。
- 请将您的儿童安全座椅存放于干燥、安全的地方。
- 存储潮湿的儿童安全座椅将利于霉菌滋生, 因此在潮湿环境中暴露过后, 存放之前请用软布彻底擦干。
- 请避免将儿童安全座椅长期置于阳光下, 因为这可能会导致布料褪色。
- 定期检查儿童安全座椅的破损迹象——如发现产品破损则停止使用。
- 请勿在清洁时拆卸或试图拆卸儿童安全座椅。这样做毫无必要且十分危险。
- 塑料和金属部件可蘸上温水和中性清洁剂用海绵擦洗干净。
- 请参阅布料上的洗水标签获取清洁说明。
- 在清洁本产品前请从椅套/座垫中取下垫片。
- 切勿使用粗糙的、氨基、含漂白剂的或酒精类清洁剂进行清洁。

可视化语言键:

	参考警告 XX		重复动作 x 次		按住
	正确动作		一般动作箭头		检查
	错误动作		锁定		继续到第 XX 步骤
	可听声		解锁		在另一侧重复

部件清单:

请参考图:

P1: 头靠	P5: ISOFIX 扣 (x2)
P2: 椅背	P6: 贮藏室
P3: 座椅	P7: 饮料架
P4: ISOFIX 手臂	

更换部件:

下列更换部件可用于您的产品。对于英国及爱尔兰客户，请通过我们的网站订货：
<http://www.cosatto.com/service-centre/spares>

对于英国和爱尔兰以外的客户，可在这个网站获取您当地经销商的联系信息：
<http://www.cosatto.com/stockists>

如您需要任何其它支持，请致信我们：cuddle@cosatto.com

S1: 头靠布套	S5: 头靠侧翼垫片 (一对)
S2: 靠背布套	S6: 靠背垫片 (一对)
S3: 底座布套	S7: ISOFIX 扣 (一对)
S4: 头靠中间垫片	S8: 饮料架

安装和操作信息:

请参考说明图:

椅背

1-

准备工作:

将椅背连接到底座 (a) 并调整到直立位置 (b)。

位置

2-

重要提示: 切勿在装有活动安全气囊的车辆座位上使用这种儿童安全座椅。如需获取解除安全气囊活动状态的信息，请参考您的车辆用户手册。

警告: 您的儿童安全座椅只能用三点式安全腰带和斜肩带正向安装在汽车前排或后排乘客座位上。

ISOFIX 手臂

3-

位置:

两个 ISOFIX 下固定点一般在车辆座椅底部和背面之间 (a)。有些车辆的 ISOFIX 显示按钮在下固定点附近 (b)。

安装 ISOFIX 扣 (可选):

4-

ISOFIX 扣可以帮助识别车辆 ISOFIX 固定点并使安装更容易。还可以帮助保护您车辆的座椅。

装配:

5-

按住 ISOFIX 连接调整按钮 并将连接完全拉开 (a)。固定 ISOFIX 臂 (b) 并确保 ISOFIX 臂安全指示器为绿色 (c)。将座椅底部向后推，直至座椅牢牢固定于座椅靠背 (d)。反向重复上述步骤并移除。

头靠

6-

调整:

7-

正确的头靠位置:

仅 ISOFIX 手臂连接

- 8- **装配:**
将儿童安全座椅放置在车辆座椅上, 面朝前 (a)。
将 ISOFIX 手臂连接至锚固点 (参见步骤 5) (b)。
用车辆安全腰带保护您的孩子 (参见步骤 9 - 10) (c)。
反向重复上述步骤并移除。
- 9- 将您的孩子放入儿童安全座椅上。
将车辆安全带从孩子周围拉出 (a) 并系上安全带扣 (b)。
通过车辆座椅安全腰带导向槽 (c) 在靠手下方穿过车辆座椅安全腰带。
将车辆安全斜背带穿过头靠的车辆斜安全带导向器 (d)。
拉紧车辆安全腰带 (a和b)。
重要提示: 车辆安全带扣的位置会影响儿童约束系统的稳定性。在事故中这可能会妨碍儿童约束系统达到其应有的保护性能。车辆安全带系好后, 安全带扣位于标记为 (X) 的位置, 则可试着将儿童约束系统安装在您车辆中的另一个座位上。
反向重复上述步骤并移除。
- 10- **装配:**
将儿童安全座椅放置在车辆座椅上, 面朝前 (a)。
收回 ISOFIX 臂 (参见步骤 5) (b)。
用车辆安全腰带保护您的孩子 (参见步骤 9 - 10) (c)。
反向重复上述步骤并移除。

仅安全带安装连接

- 11- **装配:**
将儿童安全座椅放置在车辆座椅上, 面朝前 (a)。
收回 ISOFIX 臂 (参见步骤 5) (b)。
用车辆安全腰带保护您的孩子 (参见步骤 9 - 10) (c)。
反向重复上述步骤并移除。

纺织品

- 12- **卸掉:**
将头靠抬到最高位 (a, 参考步骤 6)。
解开头靠织物罩后的头靠绑带调节器 (b) 和按扣 (c)。
将头靠织物罩从头靠斜肩带导向器 (d) 松开, 卸下织物罩。
- 13- 将椅背部分和底座部分分开 (a)。
将松紧带环和椅背部分分开 (b)。
将固定带和底座部分分开 (c)。
卸下椅背织物罩 (a) 和底座织物罩 (b)。
如需重新装入纺织品, 逆向进行上述流程。

饮料架

- 14- **卸掉:**

清单:

- 您是否确保儿童安全座椅与车辆的兼容性?
- 如果适用, 是否已停用安全气囊?
- 您的儿童安全座椅是否正确安装在车辆座椅?
- 您是否确保 ISOFIX 臂、ISOFIX 支撑腿和座椅安全指示上的安全提示?
- 您的孩子是否安全的在儿童安全座椅?
- 安全带是否正确拉紧而不扭曲?

- 要了解其他安装选择的座椅位置，请参阅 Cosatto 兼容性检查工具 (<http://cosat.to/fitchecker>) 或网站上的车辆安装清单 (<http://cosat.to/ninja2isizevl>)。
- 下面车辆图示中的编号与车辆安装清单中的座椅位置相对应。

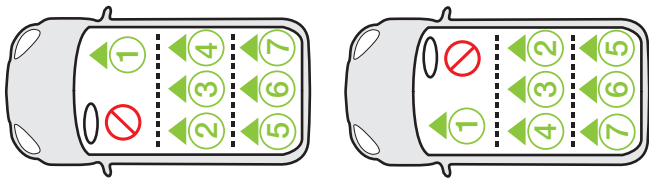

- 如果可以安装儿童约束系统，适用的座椅位置将带有 ● 标记
- 如果不可以安装儿童约束系统，适用的座椅位置将带有 ○ 标记
- 电动车辆或混合动力车辆带有 ⚡ 标记
- i-Size 车辆带有  标记
- 带有地板储物间的车辆以 **SB!** 标识——在这些车辆上安装儿童约束系统之前，请查询车辆手册。
- 座舱高度限制了儿童约束系统面向前方安装的车辆以 **!** 标识
- 如果您的车辆没有列出于清单中，或者不带有 ● 或 ○ 标记，请参阅车辆手册或者联系 Cosatto 或零售商以了解详细信息。
- 其它车辆中的座椅位置也可能适合安装儿童约束系统。如有疑问，请咨询 Cosatto 或零售商。



请确保购买前您的车辆配备有适当的 ISOFIX 固定点系统。
请务必优先安装于车辆后排座椅。



请勿将儿童约束系统安装于带有气囊的车辆座椅，除非气囊可以并已经禁用。开启气囊系统可能导致死亡或严重受伤。

- 此车辆安装清单使用从车辆和儿童约束系统所收集的科学研究精心制作。清单仅供参考，Cosatto 不对其谬误承担任何责任。
- 建议在购买时检查儿童约束系统与计划安装该系统的车辆之间是否兼容。

Importante: Conserve estas instrucciones para futura referencia.

Información de seguridad importante.

El manual de instrucciones debe guardarse de forma segura junto al sistema de retención infantil durante su vida útil:

Hay un compartimento en el lateral del asiento de coche para niños para guardar el manual de instrucciones.

Se recomienda comprobar que el sistema de retención infantil sea compatible con el vehículo en el que se pretende usar en el momento de la compra.

Consulte la lista de vehículo, la aplicación de comprobación de ajuste de Cosatto (<http://cosat.to/fitchecker>) o la sección de lista de ajuste de vehículos en el sitio web (<http://cosat.to/ninja2isizev1>).

Las posiciones de la silla en otros vehículos también pueden ser aptas para alojar el sistema de retención infantil. En caso de dudas, consulte a Cosatto o al distribuidor.

Peso y altura del niño:

- El asiento para el automóvil es adecuado para una altura de entre 100 y 150 cm, hasta un peso máximo de 36 kg.
- **IMPORTANTE: NO UTILICE EL ASIENTO PARA COCHES ORIENTADO HACIA DELANTE HASTA QUE EL NIÑO SUPERE LOS 15 MESES.**

Ubicación:

- Consulte la lista de vehículos para saber en qué parte de su vehículo podrá instalar la base del asiento de niños para coche.
- No use nunca este asiento de niños para coches en un asiento de pasajeros que esté equipado con un airbag activado. Para obtener información acerca de cómo desactivar el airbag, consulte el manual del usuario de su vehículo.
- Si el respaldo del asiento del vehículo tiene función de inclinación, coloque dicho asiento en la posición más vertical al usar el sistema de retención infantil.
- NO use el asiento de niños para coches en su hogar, ya que no ha sido diseñado para ello y, por lo tanto, solo deberá usarse en el interior de su coche.

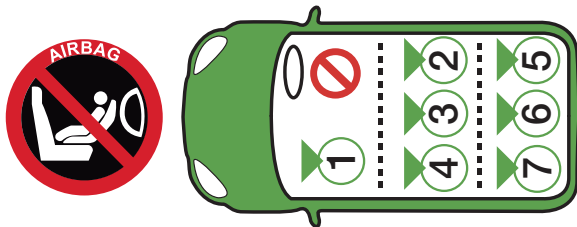

Seguridad. Le rogamos que lea atentamente lo siguiente:

- **NUNCA** use este sistema de retención infantil con el lateral orientado al asiento del vehículo.
- Cualquier objeto rígido y piezas de plástico del sistema de retención infantil deben ubicarse o instalarse de forma que no puedan, durante el uso cotidiano del vehículo, quedar atrapados al moverse un asiento o en la puerta del vehículo.
- Si se usan otros puntos de apoyo de carga distintos a los descritos en las instrucciones, puede reducirse de modo significativo el factor de protección del sistema de retención infantil.
- Asegure **SIEMPRE** a su hijo a este asiento de niños para coches utilizando el arnés de seguridad.
- Asegúrese de que el niño esté **SIEMPRE** bajo la supervisión de un adulto.
- **NO** intente desmontar, modificar ni añadir partes ni piezas a este sistema de retención infantil, ni tampoco cambiar el modo en que se utilizan y han sido fabricados los cinturones de seguridad de su vehículo.
- Después de un accidente, el sistema de retención infantil y los cinturones de seguridad del vehículo deberán reemplazarse. Aunque no hayan sufrido ningún tipo de daño aparente, es muy posible que no gocen del mismo nivel de protección que antes poseían.
- No coloque objetos como una toalla o un cojín bajo el sistema de retención infantil, ya que podría afectar a su rendimiento en caso de accidente.
- Cualquier cinturón de seguridad que sujete el sistema de retención infantil al vehículo deberá estar bien conectado y no podrá estar retorcido.
- Asegúrese siempre de que el arnés del asiento de niños para coches y el cinturón de seguridad del vehículo estén correctamente tensados a fin de garantizar la máxima protección del niño.
- Evite que el arnés/cinturón de seguridad de su vehículo puedan quedar atrapados entre las puertas del coche o bien que rocen continuamente contra piezas afiladas del asiento o del cuerpo.
- Si el arnés/los cinturones de seguridad de su vehículo sufrieran cortes o se agrietaran, reemplácelos inmediatamente antes de viajar.
- No utilice nunca recambios que no hayan recibido la autorización de Cosatto.
- Cosatto aconseja no vender ni comprar de segunda mano un sistema de retención infantil. Muchos sistemas de retención infantil adquiridos de esta manera han demostrado ser peligrosos.
- **NOTA:** El sistema de retención infantil puede marcar la tapicería de los asientos del vehículo. Cosatto no será responsable de daños o marcas causados a la tapicería de los asientos.
- Solo se garantiza la seguridad si el sistema de retención infantil se coloca como indican estas instrucciones.
- Mantenga seguro el equipaje u otros objetos que puedan causar daños al ocupante del sistema de retención infantil en caso de colisión.
- No cumplir con las instrucciones aquí detalladas sería peligroso, por lo que la garantía quedará automáticamente anulada y Cosatto se eximirá de cualquier responsabilidad.
- La hebilla ha sido diseñada para poderse desabrochar con rapidez en caso de emergencia. **NO HA SIDO FABRICADA A PRUEBA DE NIÑOS.** Los niños más curiosos pueden aprender a desabrochar la hebilla. Por ese motivo, será de suma importancia que explique a su hijo que jamás deberá jugar ni con la hebilla del arnés ni con ninguna otra pieza del asiento de niños para coches.
- La parte de la cadera del cinturón del vehículo debe llevarse de forma que asegure correctamente la pelvis del niño.

- No use nunca el asiento de niños para coches sin la funda de tejido del asiento, ya que la funda de tejido contribuye de forma activa al rendimiento integral del asiento. La funda de tejido no deberá cambiarse por ninguna otra funda que Cosatto no haya recomendado.
- Cubra el asiento de niños para coches, si este tuviese que quedar expuesto a la luz directa del sol durante un largo período de tiempo, ya que la superficie de la base del asiento de niños para coches podría alcanzar una temperatura extremadamente alta. Compruebe la superficie del asiento de niños para coches antes de colocar al niño en el asiento.
- **ADVERTENCIA:** Para evitar el riesgo de quemaduras, no coloque bebidas calientes en el portavasos.
- Portavasos - peso máximo 500 g.
- No cumplir con las instrucciones aquí detalladas sería peligroso, por lo que la garantía quedará automáticamente anulada y Cosatto se eximirá de cualquier responsabilidad.

Aviso:

1. (100 - 150cn) Este es un sistema de retención infantil mejorado de asiento elevado i-Size. Está aprobado de acuerdo con la Regulación N° 129 de la ONU, para su uso principalmente en "posiciones de asiento i-Size" según lo indicado por los fabricantes de vehículos en el manual del usuario del vehículo.
2. No use nunca este sistema de retención infantil en el asiento del pasajero con el airbag activado.
3. En caso de duda, consulte al fabricante o al vendedor del sistema de retención infantil.

Cuidado y mantenimiento:

- El sistema de retención infantil se ha diseñado para satisfacer normas de seguridad y, con un uso y mantenimiento correctos, ofrecerá un rendimiento excelente durante muchos años.
- Guarde el sistema de retención infantil en un lugar seco y seguro.
- Guardar un sistema de retención infantil húmedo fomentará el crecimiento de moho, así que, tras exponerlo a condiciones húmedas, séquelo con un paño suave y déjelo secar completamente antes de guardarlo.
- No permita que el sistema de retención infantil quede expuesto a los rayos del sol durante períodos prolongados, ya que ello podría causar la decoloración del tejido.
- Inspeccione el sistema de retención infantil con regularidad y, en caso de detectar signos de daños, deje de utilizar el producto.
- Cuando limpie el sistema de retención infantil, **NO** lo desmonte ni intente desmontarlo. Hacerlo será innecesario y peligroso.
- Las piezas y partes de plástico y de metal deberán limpiarse con una esponja suave, agua tibia y un detergente de dureza mínima.
- Lea la etiqueta de lavado y cuidados para consultar las instrucciones de limpieza del producto.
- Retire la inserción de la funda/el forro del asiento antes de lavarlo.
- No limpie nunca la unidad con limpiadores abrasivos, o basados en amoníaco, lejía o alcoholes.

Clave de lenguaje visual:

	Consulte la advertencia XX		Repetición de la acción (cuántas veces)		Pulsar y mantener pulsado
	Acción correcta		Flecha de acción general		Comprobar
	Acción incorrecta		Bloquear		Ir al paso XX
	Sonidos		Desbloquear		Repetir en el otro lado

Lista de piezas:

Consulte los diagramas:

P1: Reposacabezas

P2: Respaldo

P3: Asiento

P4: Brazo ISOFIX

P5: Guía ISOFIX (x2)

P6: Compartimiento de almacenamiento

P7: Portabebidas

Recambios:

Disponemos de todos los recambios listados a continuación para su producto. Para los clientes del Reino Unido e Irlanda, por favor realicen sus pedidos a través de nuestro sitio Web: <http://www.cosatto.com/service-centre/spares>

Para los clientes de fuera del Reino Unido e Irlanda, en <http://www.cosatto.com/stockists> encontrarán los datos de contacto de sus distribuidores locales.

Si necesita asistencia adicional, por favor póngase en contacto con nosotros en cuddle@cosatto.com

S1: Funda de tela del reposacabezas

S2: Funda de tela del respaldo

S3: Funda de tela de la base

S4: Acolchado central del reposacabezas

S5: Acolchado lateral del reposacabezas (juego)

S6: Acolchado del respaldo (juego)

S7: Guía ISOFIX (juego)

S8: Portabebidas

Información de ajuste y funcionamiento:

Consulte los diagramas de instrucciones:

Respaldo

1-

Preparación:

Conecte la sección del respaldo a la sección de la base (a) y recline el respaldo hasta la posición vertical (b).

Ubicación

2-

IMPORTANTE: No use nunca la silla infantil en un asiento del vehículo que esté equipado con un airbag activado. Para obtener información acerca de cómo desactivar el airbag, consulte el manual del usuario de su vehículo.

ADVERTENCIA: La silla infantil solo puede instalarse en el sentido de la marcha utilizando un cinturón de seguridad de tres puntos de anclaje en los asientos delanteros o traseros del vehículo.

- Brazo ISOFIX** 3- **Ubicación:**
Los dos puntos de anclaje bajo ISOFIX suelen estar situados entre la base y el respaldo del asiento del vehículo (a). Algunos vehículos tienen un indicador ISOFIX cerca de los puntos de anclaje bajo ISOFIX (b).
- 4- **Ajuste de las guías ISOFIX (Opcional):**
Las guías ISOFIX pueden ayudar a identificar los puntos de anclaje ISOFIX del vehículo y facilitar la instalación. También pueden ayudar a proteger el asiento de su vehículo.
- 5- **Encaje:**
Pulse y mantenga los botones de ajuste del brazo ISOFIX y extienda los brazos por completo (a). Acople los brazos ISOFIX (b) y asegúrese de que los indicadores de seguridad del brazo ISOFIX estén de color verde (c). Empuje la base hacia atrás hasta que quede apoyada firmemente contra el respaldo del asiento del vehículo (d). Para la extracción, realice el procedimiento contrario.
- Reposacabezas** 6- **Ajuste:**
7- **Posición correcta del reposacabezas:**
- Solo con los brazos ISOFIX** 8- **Encaje:**
Coloque el sistema de retención infantil (sillita) en el asiento del vehículo mirando hacia delante (a). Enganche los brazos ISOFIX a los puntos de anclaje (consulte los pasos 5) (b). Asegure a su hijo con el cinturón de seguridad del vehículo (consulte el paso 9 - 10) (c). Para la extracción, realice el procedimiento contrario.
- Cinturón del vehículo** 9- Coloque al niño en la sillita. Extraiga el cinturón del vehículo tirando de él, páselo alrededor del niño (a) y abroche la hebilla (b). El cinturón de cadera debe pasar por las guías del cinturón de cadera (c) bajo los reposabrazos. Pase el cinturón diagonal del vehículo por la guía para el cinturón diagonal del reposacabezas (d).
10- Tense el cinturón de seguridad del vehículo (a & b). **IMPORTANTE:** La posición de la hebilla del cinturón de seguridad del vehículo puede afectar a la estabilidad del sistema de retención infantil. En caso de accidente, esto podría evitar que el sistema de retención infantil protegiera a su hijo de la forma debida. Si, una vez que el cinturón de seguridad está bien abrochado, la hebilla está en la posición marcada (X), deberá intentar instalar el sistema de retención infantil en otra posición diferente dentro del vehículo. Para la extracción, realice el procedimiento contrario.

Solo con cinturón

- 11- **Encaje:**
Coloque el sistema de retención infantil (sillita) en el asiento del vehículo mirando hacia delante(a).
Retraiga los brazos ISOFIX (consulte el paso 5) (b).
Asegure a su hijo con el cinturón de seguridad del vehículo (consulte el paso 9 - 10) (c).
Para la extracción, realice el procedimiento contrario.

Accesorios de tela

- 12- **Extracción:**
Ponga el reposacabezas en su posición más alta (a, consulte el paso 6).
Desabroche la correa de ajuste del reposacabezas (b) y los corchetes (c) situados en la parte trasera de la funda de tela del reposacabezas.
Suelte la funda de tela del reposacabezas de las guías de la sección diagonal del cinturón en el reposacabezas (d) y retire la funda de tela.
- 13- Desconecte la sección del respaldo de la sección de la base (a).
Desconecte los aros elásticos de la sección del respaldo (b).
Desconecte las correas de sujeción de la sección de la base (c).
Retire la funda de tela del respaldo (a) y la funda de tela de la base (b).
Para volver a instalar los accesorios de tela, siga los procedimientos anteriores en el sentido inverso.

Portabebidas 14- **Encaje:**

Lista de comprobación:

- ¿Ha comprobado la compatibilidad de la sillita con el vehículo en el que la colocará?
- De ser pertinente, ¿está desactivado el airbag?
- ¿La sillita se ha colocado correctamente en el asiento del vehículo?
- ¿Ha comprobado los indicadores de seguridad de los brazos ISOFIX, de la pata de apoyo ISOFIX y de seguridad del asiento?
- ¿El niño está colocado de forma segura en la sillita?
- ¿El arnés está tensado correctamente y no está torcido?

- Para posiciones de asiento con otras opciones de ajuste, consulte la aplicación de comprobación de ajuste de Cosatto (<http://cosat.to/fitchecker>) o la sección de lista de ajuste de vehículos en el sitio web (<http://cosat.to/ninja2isizevl>).
- Los números del siguiente diagrama del vehículo corresponden a las posiciones de la silla incluidas en la lista de ajuste de vehículos.

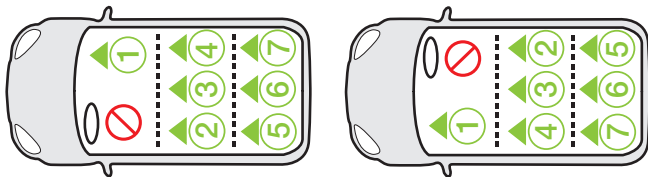

- Si puede ajustarse el sistema de retención infantil, la posición o posiciones adecuadas de la silla se marcan con ●
- Si no puede ajustarse el sistema de retención infantil, la posición o posiciones adecuadas de la silla se marcan con ○
- Los vehículos eléctricos o híbridos se marcan con ⚡
- Los vehículos de tamaño-i se marcan con
- Los vehículos con compartimentos de almacenamiento bajo el suelo se marcan con **SB!**
- Consulte el manual del vehículo antes de ajustar este sistema de retención infantil en dichos vehículos.
- Los vehículos que tengan una altura que puede impedir la instalación del sistema de retención infantil en el sentido de la marcha se marcan con !
- Si su vehículo no se encuentra en esta lista o no está marcado con el icono ● o ○, consulte el manual del vehículo o póngase en contacto con Cosatto o con el distribuidor para obtener más información.
- Las posiciones de la silla en otros vehículos también pueden ser aptas para alojar el sistema de retención infantil. En caso de dudas, consulte a Cosatto o al distribuidor.



Antes de comprar el vehículo, asegúrese de que esté equipado con los anclajes adecuados.

Dé SIEMPRE prioridad a los asientos traseros.



NO coloque el sistema de retención infantil en el asiento de un vehículo con airbag incorporado, a menos que pueda desactivarse y esté desactivado. Un sistema de AIRBAG activado puede causar la muerte o lesiones graves.

- Esta lista de ajuste de vehículos se ha preparado cuidadosamente con datos científicos recopilados tanto de vehículos como del sistema de retención infantil. Cosatto no acepta ninguna responsabilidad en relación con inexactitudes de la lista, que solo es orientativa.
- Se recomienda comprobar que el sistema de retención infantil sea compatible con el vehículo en el que se pretende usar en el momento de la compra.

P

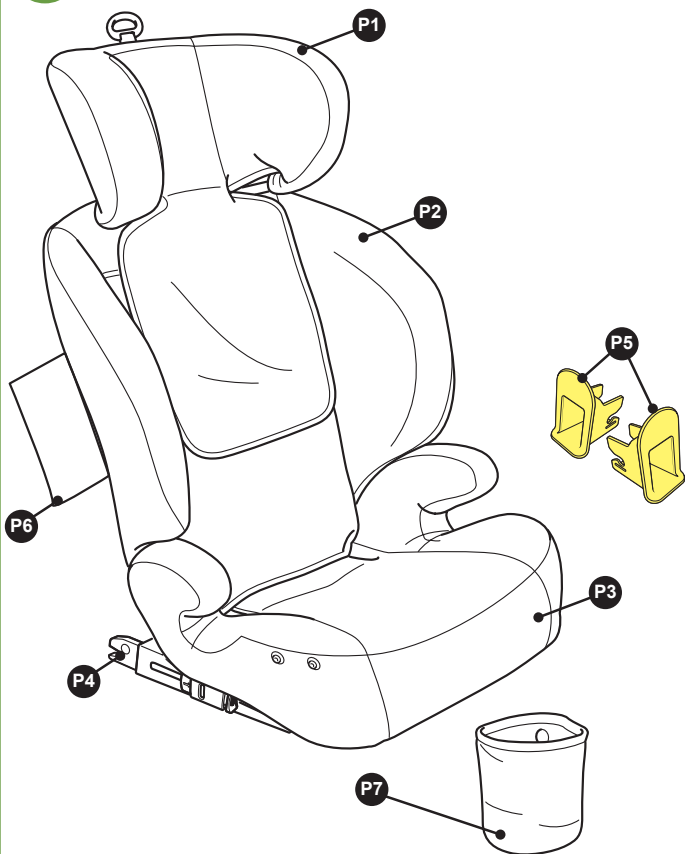

S

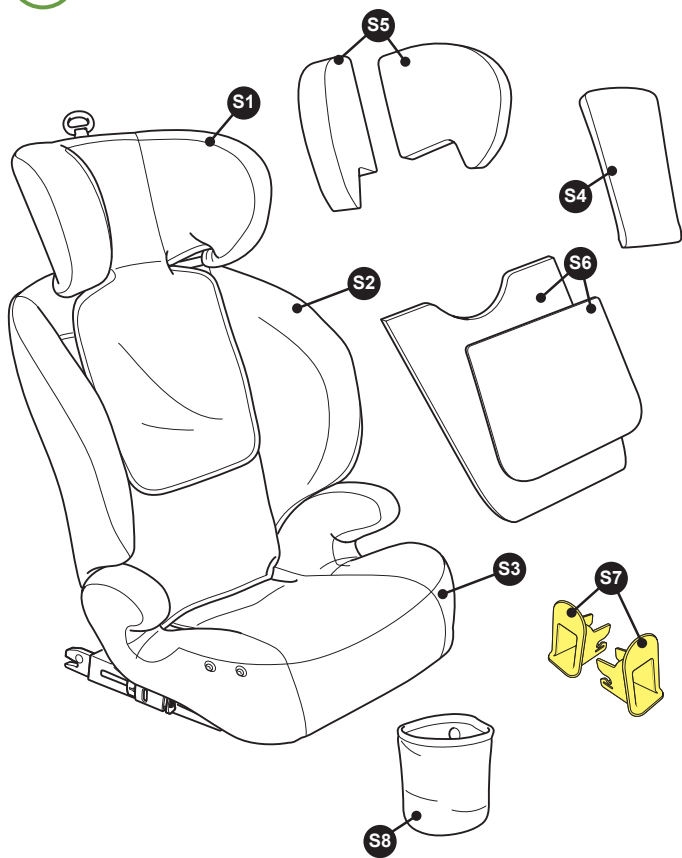

1

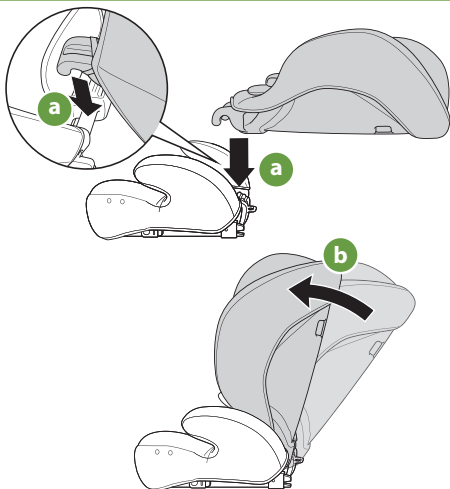

2

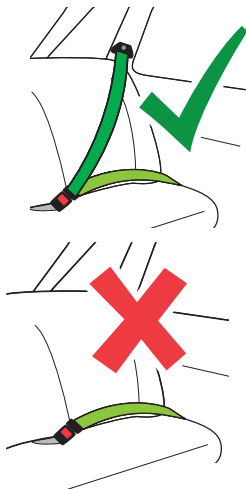
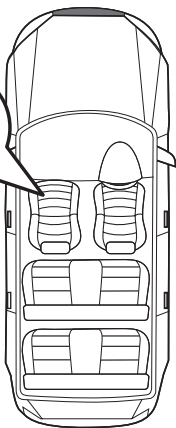

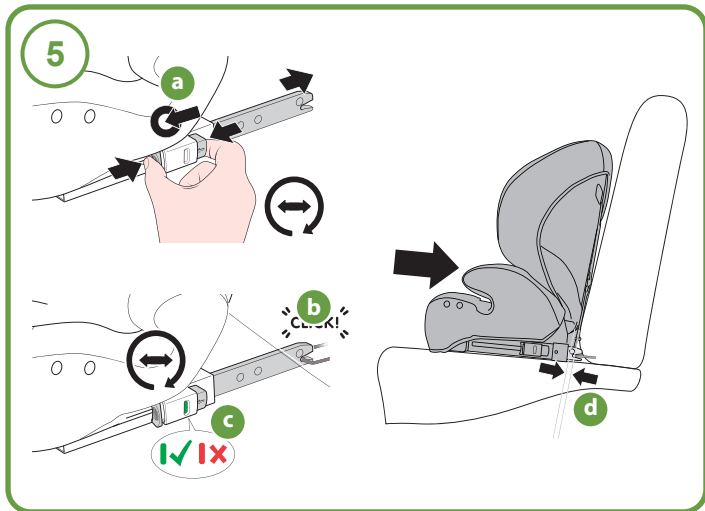
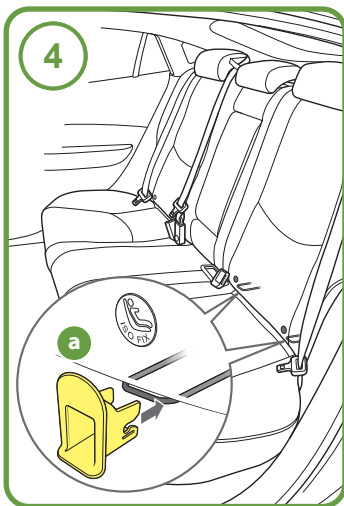
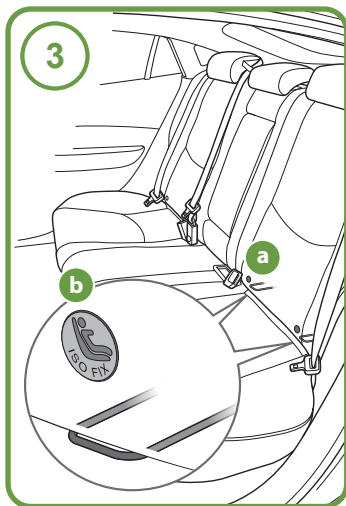

6

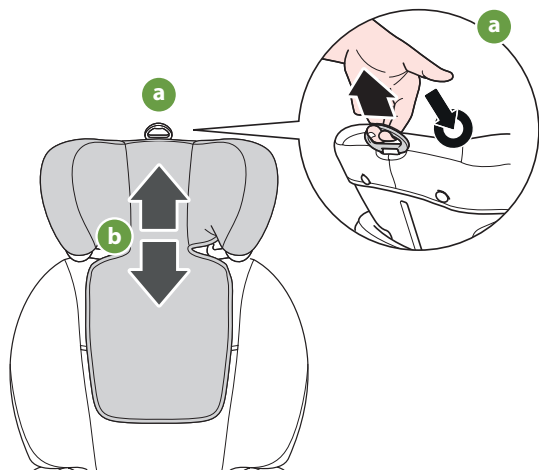

7

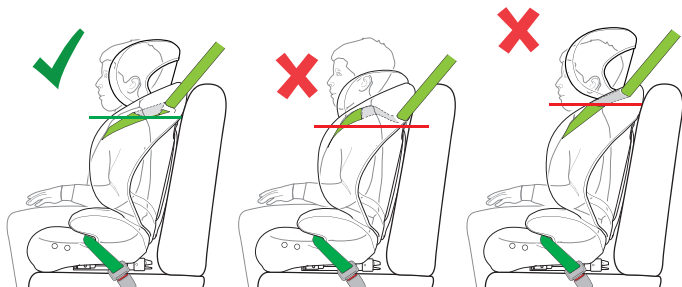

8

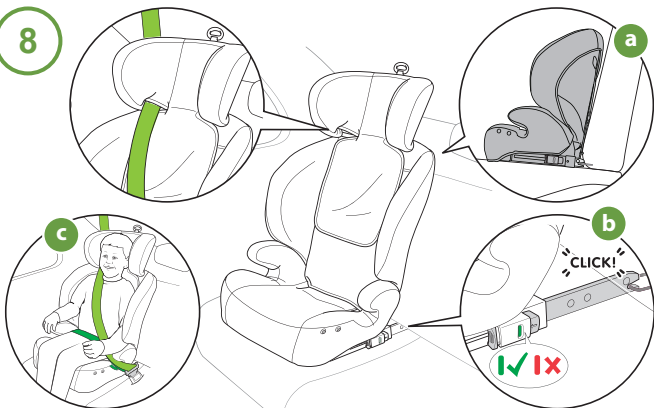

100 - 150cm
+ ISOFIX

9

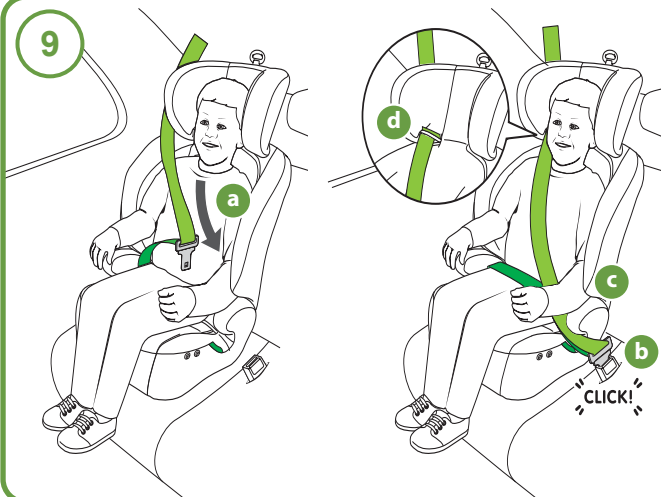

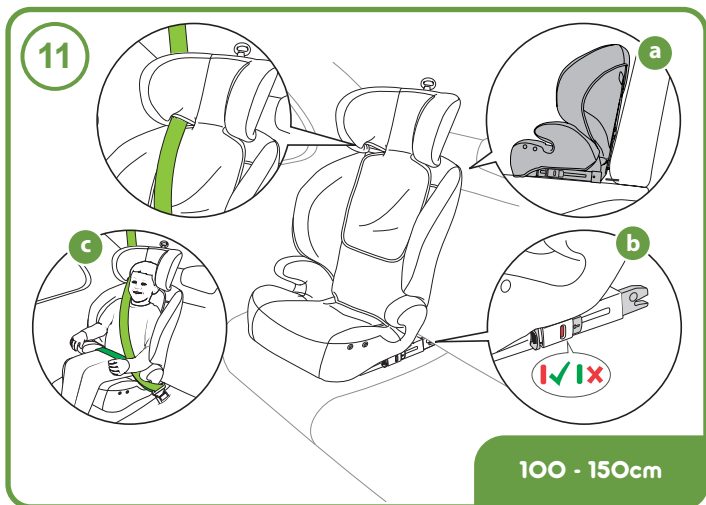
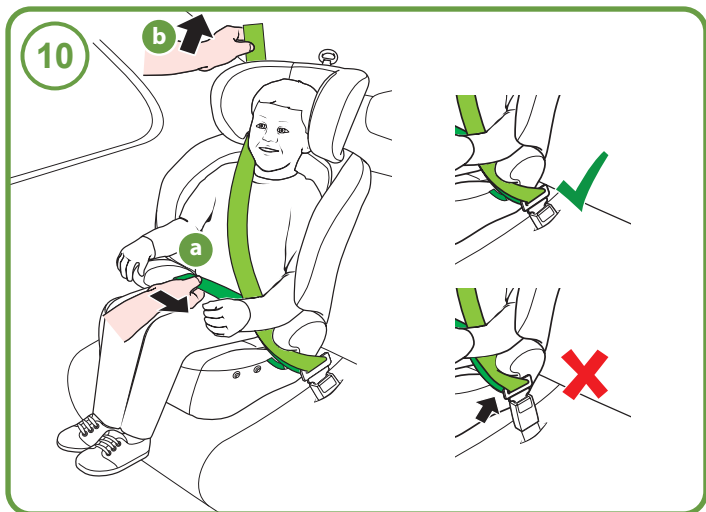

12

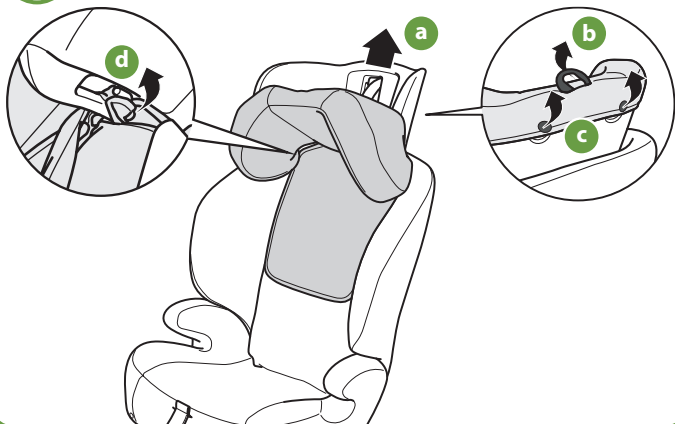

13

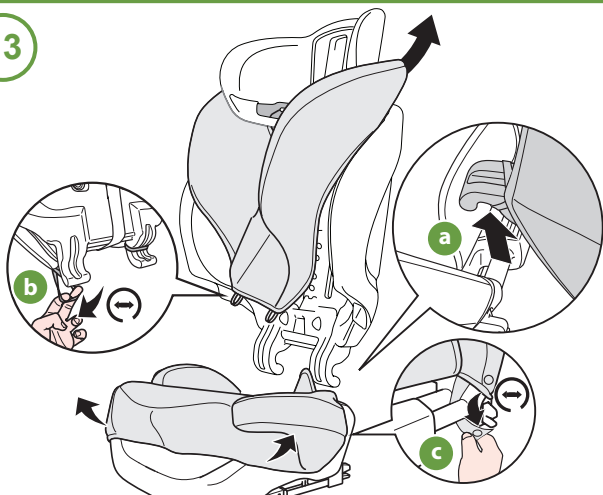

14

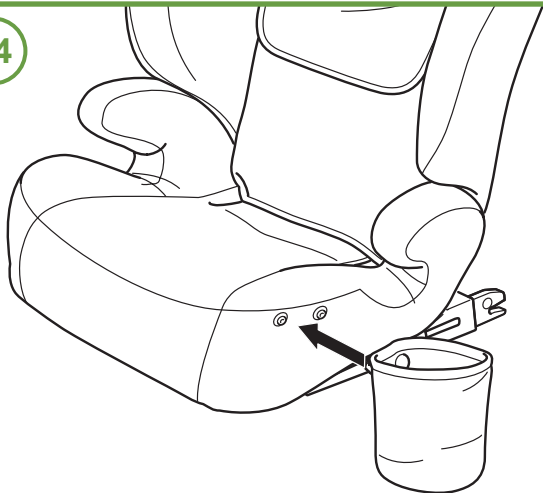





ML17022023





1 2 3 4 5 6 7

Alfa Romeo

Giulietta (2010 >)	○	●	○	●	-	-	-
Giulia (2017 >)	○	●	○	●	-	-	-
Mito (2009 >)	○	●	-	●	-	-	-
Stelvio (2017 >)	○	●	○	●	-	-	-

Audi

A1 (2011 - 2019)	○	●	○	●	-	-	-
A1 Sportback (2012 - 2019)	○	●	○	●	-	-	-
 A1 (2019 >)	○	●	○	●	-	-	-
A3 Hatchback (2012 >)	●	●	○	●	-	-	-
A3 (1996 - 2003)	○	●	○	●	-	-	-
A3 (2004 - 2011)	○	●	○	●	-	-	-
A3/S3 (2012 >)	●	●	○	●	-	-	-
 A3 e-Tron Sportback (2015 >)	●	●	○	●	-	-	-
A3 Saloon (2014 >)	●	●	○	●	-	-	-
A4 (2005 - 2008)	○	●	○	●	-	-	-
 A4 (2016 >)	●	●	○	●	-	-	-
 A4 Avant (2016 >)	●	●	○	●	-	-	-
A4 Allroad (2008 - 2016)	●	●	○	●	-	-	-
A4/S4 Avant (2008 - 2016)	●	●	○	●	-	-	-
A4/S4 Saloon (2008 - 2016)	●	●	○	●	-	-	-
A5/S5 Coupe (2016 >)	●	●	-	●	-	-	-
A5/S5 Coupe (2006 - 2016)	●	●	-	●	-	-	-
A5/S5 Sportback (2009 - 2016)	●	●	○	●	-	-	-
A5/S5 Sportback (2017 >)	●	●	○	●	-	-	-
 Audi A5/S5 Cabriolet (2017 >)	●	●	-	●	-	-	-



	1	2	3	4	5	6	7
A6 Allroad (2011 - 2016)	●	●	○	●	-	-	-
A6/S6 Avant (2011 - 2016)	●	●	○	●	-	-	-
A6/S6 (2011 - 2016)	●	●	○	●	-	-	-
A6/S6 (2016 >)	●	●	○	●	-	-	-
A6 Allroad (2016 >)	●	●	○	●	-	-	-
A7 Sportback (2011 - 2015)	●	●	○	●	-	-	-
A7/S7 Sportback (2016 - 2018)	●	●	○	●	-	-	-
A7/S7 Sportback (2018 >)	●	●	○	●	-	-	-
 A8/S8 (2018 >)	○	●	○	●	-	-	-
A8/S8 (2011 - 2017)	○	●	○	●	-	-	-
 Q2 (2016 >)	●	●	○	●	-	-	-
Q3/SQ3 (2013 - 2018)	○	●	○	●	-	-	-
 Q3/SQ3 (2019 >)	●	●	○	●	-	-	-
Q5/SQ5 (2008 - 2012)	●	●	○	●	-	-	-
Q5/SQ5 (2012 - 2016)	●	●	○	●	-	-	-
Q5/SQ5 (2017 >)	●	●	○	●	-	-	-
Q7 (2006 - 2014)	●	●	○	●	○	-	○
 Q7/SQ7 (2015 >)	●	●	○	●	○	-	○
 Q8 (2018 >)	●	●	○	●	-	-	-
TT Coupe (2006 - 2017)	●	○	-	○	-	-	-
TT Coupe (2017 >)	●	○	-	○	-	-	-

Bentley

Continental GT (2003 - 2012)	●	●	-	●	-	-	-
Continental Flying Spur (2005-2012)	○	●	○	●	-	-	-
Continental GTC (2006 - 2012)	●	○	-	○	-	-	-
Mulsanne (2010 >)	○	●	○	●	-	-	-

	1	2	3	4	5	6	7
BMW							
1-Series (2004 - 2011)	○	●	○	●	-	-	-
1 Series Convertible (2008 - 2015)	●	●	-	●	-	-	-
1 Series Coupe (2008 - 2015)	●	●	-	●	-	-	-
1 Series F20 (2011 >)	○	●	○	●	-	-	-
2 Series Active Tourer (2015 >)	●	●	○	●	-	-	-
2 Series Coupe (2014 >)	●	●	-	●	-	-	-
3 Series (2002 - 2005)	○	●	○	●	-	-	-
3 Series (2005 - 2011)	○	●	○	●	-	-	-
3 Series Coupe (2007 - 2014)	●	●	-	●	-	-	-
3 Series F30 (2012 >)	○	●	○	●	-	-	-
4 Series GC (2014 >)	○	●	○	●	-	-	-
5 Series Saloon (2003 - 2008)	○	●	○	●	-	-	-
5 Series Touring (2003 - 2008)	○	●	○	●	-	-	-
5 Series (2008 - 2010)	○	●	○	●	-	-	-
5 Series Touring (2011 -2018)	○	●	○	●	-	-	-
5 Series Saloon (2011 - 2018)	○	●	○	●	-	-	-
5 Series (2011 - 2018)	○	●	○	●	-	-	-
 5 Series (2018 >)	○	●	○	●	-	-	-
6 Series Coupe (2011 >)	○	●	-	●	-	-	-
6 Series Convertible (2011 >)	○	●	-	●	-	-	-
6 Series Gran Coupe (2011 >)	○	●	○	●	-	-	-
7 Series (2010 - 2016)	○	●	○	●	-	-	-
7 Series (2016 >)	○	●	○	●	-	-	-
⚡ i3 (2014 >)	○	●	○	●	-	-	-
i8 (2014 >)	○	○	-	○	-	-	-
X1 (2010 - 2015)	○	●	○	●	-	-	-

1 2 3 4 5 6 7

 X1 (2016 >)	●	●	○	●	-	-	-
X3 F25 (2011 - 2018)	○	●	○	●	-	-	-
X3 G01 (2018 >)	○	●	○	●	-	-	-
 X4 (2014 >)	○	●	○	●	-	-	-
X5 (2007 - 2014)	○	●	○	●	○	-	○
X5 (2015 >)	○	●	○	●	○	-	○
X6 (2008 >)	○	●	○	●	-	-	-
X6 (2015 >)	○	●	○	●	-	-	-
3-GT (2013 >)	○	●	○	●	-	-	-
5-GT (2010 >)	○	●	○	●	-	-	-

Cadillac

BLS Saloon (2006 - 2011)	○	●	○	●	-	-	-
--------------------------	---	---	---	---	---	---	---

Chevrolet





Aveo (2012 >)	○	●	○	●	-	-	-
Captiva (2007 >)	○	●	○	●	○	-	○
Cruze (2009 >)	○	●	○	●	-	-	-
Spark (2012 >)	○	●	○	●	-	-	-
Volt (2011 >)	○	●	-	●	-	-	-
Orlando (2011 >)	○	●	○	●	○	-	○
Traxx (2013 >)	○	●	○	●	-	-	-

Chrysler

Grand Voyager (2008 >)	○	●	-	●	○	○	○
300 C (2012 >)	○	●	○	●	-	-	-
Delta (2011 >)	○	●	○	●	-	-	-
Ypsilon (2011 >)	○	●	○	●	-	-	-

1 2 3 4 5 6 7

Citroen

SB! Citroen Berlingo II (2008 >)	○	●	○	●	-	-	-
SB! Berlingo Multispace (2007 >)	○	●	○	●	○	-	○
C1 (2006 - 2015)	○	●	-	●	-	-	-
C1 (2015 >)	○	●	-	●	-	-	-
C3 (2005 - 2009)	○	●	○	●	-	-	-
C3 5 Door (2009 >)	○	●	○	●	-	-	-
SB! C3 Picasso (2009 >)	○	●	○	●	-	-	-
C3 (2017 >)	●	●	○	●	-	-	-
 C3 Aircross (2017 >)	○	●	○	●	-	-	-
C4 (2010 >)	○	●	○	●	-	-	-
SB! C4 Picasso (2007 - 2014)	○	●	○	●	○	-	○
SB! C4 Picasso (2014 >)	○	●	●	●	○	-	○
SB! C4 G-Picasso (2007 - 2013)	○	●	○	●	○	-	○
C5 (2006 - 2008)	○	●	○	●	-	-	-
C5 Saloon (2008 >)	○	●	○	●	-	-	-
C5 Tourer (2008 >)	○	●	○	●	-	-	-
 C4-Cactus (2015 >)	○	●	○	●	-	-	-
C-Crosser (2007 - 2012)	○	●	○	●	-	-	-
 C5 Aircross (2019 >)	●	●	○	●	-	-	-
DS3 (2011 >)	○	●	○	●	-	-	-
 DS3 Crossback (2019 >)	●	●	○	●	-	-	-
DS4 (2011 >)	○	●	○	●	-	-	-
DS5 (2013 >)	○	●	○	●	-	-	-
 DS7 (2018 >)	●	●	○	●	-	-	-
Jumpy (2007 - 2012)	○	●	○	●	●	○	●
Nemo (2008 >)	○	●	○	●	-	-	-

1 2 3 4 5 6 7

Xsara (2000 - 2006) ○ ○ ○ ○ - - -

Dacia











Duster (2012 >) ○ ● ○ ● - - -
 Logan MCV (2013 >) ○ ● ○ ● - - -
 Sandero (2013 >) ○ ● ○ ● - - -







Fiat





124 Spider (2016 >) ● - - - - - -
 500 (2008 >) ○ ● - ● - - -
 500 C (2009 >) ○ ● - ● - - -
 Abarth 500 (2009 >) ○ ● - ● - - -
 Bravo (2007 >) ○ ● ○ ● - - -
 500L (2013 >) ○ ● ○ ● - - -
 500X (2015 >) ○ ● ○ ● - - -
 Doblo (2010 >) ○ ● ○ ● - - -
 Panda (2012 >) ○ ● ○ ● - - -
 Grande Punto (2006 >) ○ ● ○ ● - - -
 Abarth Grande Punto (2008 - 2011) ○ ● ○ ● - - -
 Qubo (2008 >) ○ ● ○ ● - - -
 Tipo (2016 >) ○ ● ○ ● - - -

Ford

 B Max (2012 >) ○ ● ○ ● - - -
 SB! Focus C Max (2003 - 2010) ○ ○ ○ ○ - - -
 C Max (2010 -2012) ○ ● ○ ● - - -
 C Max (2013 >) ○ ● ○ ● - - -

	1	2	3	4	5	6	7
 Edge (2016 >)	○	●	○	●	○	-	○
Fiesta (2004 - 2008)	○	○	○	○	-	-	-
Fiesta (2008 - 2017)	○	●	○	●	-	-	-
 Fiesta (2017 >)	○	●	○	●	-	-	-
Focus (1998 - 2005)	○	○	○	○	-	-	-
Focus (2005 - 2009)	○	○	○	○	-	-	-
Focus (2010 - 2015)	○	●	○	●	-	-	-
 Focus (2015 - 2018)	○	●	○	●	-	-	-
⚡ Focus Electric (2015 >)	○	●	○	●	-	-	-
 Focus (2018 >)	○	●	○	●	-	-	-
SB! Galaxy (2006 - 2015 >)	○	●	○	●	○	-	○
 Galaxy (2016 >)	○	●	○	●	○	-	○
KA (2009 - 2016)	○	○	-	○	-	-	-
 KA+ (2016 >)	○	●	○	●	-	-	-
Kuga (2008 - 2012)	○	●	○	●	-	-	-
Kuga (2013 >)	○	●	○	●	-	-	-
 Kuga (2020 >)	●	●	○	●	-	-	-
Mondeo (2002 - 2007)	○	○	○	○	-	-	-
Mondeo Estate (2007 - 2014)	○	●	○	●	-	-	-
Mondeo Hatchback (2007 - 2014)	○	●	○	●	-	-	-
Mondeo Saloon (2007 - 2014)	○	●	○	●	-	-	-
 Mondeo (2014 >)	○	●	○	●	-	-	-
 Puma (2020 >)	○	●	○	●	-	-	-
Ranger Double-Cab Pickup (2019 >)	○	●	○	●	-	-	-
SB! S Max (2006 - 2015 >)	○	●	○	●	○	-	○
 S Max (2016 >)	○	●	○	●	○	-	○
 EcoSport (2015 >)	○	●	○	●	-	-	-

	1	2	3	4	5	6	7
Honda							
Accord Saloon (2008 >)	○	●	○	●	-	-	-
Accord Tourer (2008 >)	○	●	○	●	-	-	-
Civic (2012 - 2018)	○	●	○	●	-	-	-
Civic (2006 - 2011)	○	●	○	●	-	-	-
Civic Hybrid Saloon (2006 - 2010)	○	●	○	●	-	-	-
Civic Type R (2007 - 2010)	○	●	○	●	-	-	-
Civic Tourer (2014 >)	○	●	○	●	-	-	-
 Civic (2018 >)	○	●	○	●	-	-	-
CRV (2007 - 2013)	○	●	○	●	-	-	-
CRV (2012 >)	○	●	○	●	-	-	-
 CRV (2019 >)	○	●	○	●	○	-	○
 Honda E (2021 >)	○	●	○	●	-	-	-
Elysion (2012 >)	○	●	○	●	○	-	○
FRV (2006 - 2011)	○	●	○	●	-	-	-
 HR-V (2015 >)	○	●	○	●	-	-	-
Insight (2009 >)	○	●	○	●	-	-	-
Jazz (2002 - 2008)	○	○	○	○	-	-	-
Jazz (2008 - 2015)	○	●	○	●	-	-	-
 Jazz (2016 >)	○	●	○	●	-	-	-
 Jazz /Crosstar (2020 >)	○	●	○	●	-	-	-
Legend (2006 - 2010)	○	●	○	●	-	-	-
Odyssey (2010 >)	○	○	-	○	-	-	-
Hyundai							
Getz (2005 - 2011)	○	●	○	●	-	-	-
i10 Hatchback (2008 >)	○	●	○	●	-	-	-





	1	2	3	4	5	6	7
i20 Hatchback (2009 >)	○	●	○	●	-	-	-
i20 (2015 >)	○	●	○	●	-	-	-
i30 (2012 - 2015)	○	●	○	●	-	-	-
i30 (2015 >)	○	●	○	●	-	-	-
i40 (2011 >)	○	●	○	●	-	-	-
iX20 (2011 >)	○	●	○	●	-	-	-
iX35 (2010 >)	○	●	○	●	-	-	-
i800/H1 (2008 >)	○	●	●	●	○	○	○
 Ioniq (2016 >)	○	●	○	●	-	-	-
 Kona (2017 >)	○	●	○	●	-	-	-
Santa Fe (2007 - 2012)	○	●	○	●	○	-	○
Santa Fe (2012 >)	○	●	○	●	○	-	○
Tucson (2010 >)	○	●	○	●	-	-	-
 Tucson (2015 >)	○	●	○	●	-	-	-
Veloster (2012 >)	○	○	-	○	-	-	-
 Genesis G80 (2021>)	○	●	○	●	-	-	-
 Genesis GV80 (2021>)	○	●	○	●	○	-	○

Infiniti

EX (2009 >)	○	●	○	●	-	-	-
FX (2009 >)	○	●	○	●	-	-	-
G Coupe (2009 >)	○	○	○	○	-	-	-
G Saloon (2009 >)	○	●	○	●	-	-	-
M (2010 >)	○	●	○	●	-	-	-

Jaguar

E-Pace (2018 >)	○	●	○	●	-	-	-
-----------------	---	---	---	---	---	---	---









	1	2	3	4	5	6	7
 F - Pace (2016 >)	○	●	○	●	-	-	-
F-Type Coupe (2014 >)	○	-	-	-	-	-	-
 I - Pace (2018 >)	○	●	○	●	-	-	-
X-Type (2001 - 2010)	○	○	○	○	-	-	-
X-Type Estate (2004 - 2010)	○	○	○	○	-	-	-
 XE (2015 >)	○	●	○	●	-	-	-
XF (2008 - 2014)	○	●	○	●	-	-	-
 XF (2015 >)	○	●	○	●	-	-	-
XF R (2009 - 2015)	○	●	○	●	-	-	-
XF Sportbrake (2013 >)	○	●	○	●	-	-	-
XJ (2010 >)	○	●	○	●	-	-	-
XK (2006 - 2016)	○	●	-	●	-	-	-
! XK Coupe (2006 - 2016)	○	○	-	○	-	-	-
XK Convertible (2006 - 2016)	○	○	-	○	-	-	-

Jeep

Grand Cherokee (2011 >)	○	●	○	●	-	-	-
Compass (2011 >)	○	●	○	●	-	-	-
Cherokee (2014 >)	○	●	○	●	-	-	-
 Renegade (2015 >)	○	●	○	●	-	-	-
Wrangler 5dr (2007 >)	○	●	○	●	-	-	-



Kia

SB! Carens (2013 >)	○	●	○	●	○	-	○
Ceed Hatchback (2012 >)	○	●	○	●	-	-	-
 Ceed/XCeed (2020 >)	○	●	○	●	-	-	-
 EV6 (2022 >)	○	●	○	●	-	-	-

	1	2	3	4	5	6	7
 ProCeed (2020 >)	○	●	○	●	-	-	-
 Niro (2017 >)	○	●	○	●	-	-	-
Optima (2011 - 2015)	○	●	○	●	-	-	-
 Optima (2016 >)	○	●	○	●	-	-	-
Picanto (2008 - 2011)	○	●	○	●	-	-	-
Picanto (2011 - 2017)	○	●	○	●	-	-	-
 Picanto (2018 >)	○	●	○	●	-	-	-
Rio (2012 - 2017)	○	●	○	●	-	-	-
 Rio (2017 >)	○	●	○	●	-	-	-
Sorento (2003- 2009)	○	●	○	●	-	-	-
Sorento (2010 - 2014)	○	●	○	●	-	-	-
Sorento (2015 >)	○	●	○	●	○	-	○
 Sorento (2020 >)	○	●	○	●	●	-	●
Soul (2009 >)	○	●	○	●	-	-	-
 Soul EV (2015 >)	○	●	○	●	-	-	-
Sportage (2011 - 2015)	○	●	○	●	-	-	-
 Sportage (2016 >)	○	●	○	●	-	-	-
 Stonic (2016 >)	○	●	○	●	-	-	-
Venga (2010 >)	○	●	○	●	-	-	-

Land Rover





 Defender (2020 >)	●	●	○	●	○	-	○
Discovery Sport (2015 >)	○	●	○	●	○	-	○
Discovery 4 (2009 >)	○	●	○	●	○	-	○
 Discovery 5 (2018 >)	●	●	○	●	●	-	●
Freelander 2 (2006 >)	○	●	○	●	-	-	-
Range Rover (2013 >)	○	●	○	●	-	-	-

	1	2	3	4	5	6	7
Range Rover (2002 - 2012)	○	●	○	●	-	-	-
Range Rover Sport (2005 - 2012)	○	●	○	●	-	-	-
Range Rover Sport (2013 >)	○	●	○	●	○	-	○
Range Rover Evoque 3dr (2011 >)	○	●	○	●	-	-	-
Range Rover Evoque 5dr (2011 >)	○	●	○	●	-	-	-
 Range Rover Evoque (2019 >)	○	●	○	●	-	-	-
 Range Rover Velar (2017 >)	○	●	○	●	-	-	-

Lancia



Thema (2012 >)	○	●	○	●	-	-	-
Voyager (2010 >)	○	●	○	●	○	-	○
Delta (2011 >)	○	●	○	●	-	-	-
Ypsilon (2012 >)	○	●	○	●	-	-	-

Lexus

CT (2011 >)	○	●	○	●	-	-	-
GS (2013 >)	○	●	○	●	-	-	-
 GSh (2013 >)	○	●	○	●	-	-	-
IS Saloon (2005 - 2012)	○	●	○	●	-	-	-
 NX (2014 >)	○	●	○	●	-	-	-
 ES Hybrid (2019 >)	○	●	○	●	-	-	-
 UX (2019 >)	○	●	○	●	-	-	-
RX (2010 - 2018)	○	●	○	●	-	-	-
 RX (2018 >)	○	●	○	●	○	-	○









Mazda





 CX-3 (2015 >)	●	●	○	●	-	-	-
---	---	---	---	---	---	---	---

	1	2	3	4	5	6	7
CX-5 (2011 >)	○	●	○	●	-	-	-
CX-7 (2007 - 2011)	○	●	○	●	-	-	-
Mazda 2 (2009 - 2015)	○	●	○	●	-	-	-
 Mazda 2 (2015 >)	○	●	○	●	-	-	-
3 Hatchback (2009 - 2013)	○	●	○	●	-	-	-
3 Saloon (2009 - 2013)	○	●	○	●	-	-	-
3 Hatchback (2014 >)	○	●	○	●	-	-	-
5 (2005 - 2010)	○	●	○	●	-	-	-
6 Estate (2008 - 2012)	○	●	○	●	-	-	-
6 Hatchback (2007 - 2012)	○	●	○	●	-	-	-
6 Saloon (2007 - 2009)	○	●	○	●	-	-	-
6 (2013 - 2017)	○	●	○	●	-	-	-
 6 (2018 >)	○	●	○	●	-	-	-
MX-5 (2015 >)	○	-	-	-	-	-	-

Mercedes-Benz



A Class (2005 - 2012)	○	●	○	●	-	-	-
A Class (2013 >)	○	●	○	●	-	-	-
 A Class (2019 >)	○	●	○	●	-	-	-
A Class Saloon (2020 >)	○	●	○	●	-	-	-
B Class (2012 >)	○	●	○	●	-	-	-
 B Class EV (2015 >)	○	●	○	●	-	-	-
C Class (2008 - 2015)	○	●	○	●	-	-	-
C Class Estate (2008 - 2015)	○	●	○	●	-	-	-
C Class Coupe (2011 >)	○	●	-	●	-	-	-
C Class (2015 >)	○	●	○	●	-	-	-
CLA (2013 >)	○	●	○	●	-	-	-

	1	2	3	4	5	6	7
 CLA (2020 >)	○	●	○	●	-	-	-
 CLA Shooting Brake (2015 >)	○	●	○	●	-	-	-
CLS Shooting Brake (2012 >)	○	●	○	●	-	-	-
CLS Coupe (2011 >)	○	●	○	●	-	-	-
E Class (2006 - 2009)	○	●	○	●	-	-	-
E Class Saloon (2009 - 2012)	○	●	○	●	-	-	-
E Class Coupe (2009 >)	○	●	-	●	-	-	-
E Class (2013 - 2018)	○	●	○	●	-	-	-
 E Class (2018 >)	○	●	○	●	-	-	-
 ⚡EQA (2021 >)	○	●	○	●	-	-	-
 ⚡EQC (2021 >)	○	●	○	●	-	-	-
 GLA (2021 >)	○	●	○	●	-	-	-
GLA (2014 - 2020)	○	●	○	●	-	-	-
 GLC (2016 >)	○	●	○	●	-	-	-
GLC Coupe (2019 >)	○	●	○	●	-	-	-
GL Class (2006 - 2012)	○	●	○	●	○	-	○
GL/GLS Class (2012 >)	○	●	○	●	●	-	●
GLE (2015 - 2020)	○	●	○	●	-	-	-
 GLE (2020 >)	○	●	○	●	○	-	○
M/ML Class (2005 - 2012)	○	●	○	●	-	-	-
M/ML Class (2012 >)	○	●	○	●	-	-	-
R Class (2006 - 2012)	○	●	○	●	○	-	○
S Class (2006 - 2013)	○	●	○	●	-	-	-
S Class (2015 >)	○	●	○	●	-	-	-
SL Class (2012 >)	○	-	-	-	-	-	-
SLK (2011 >)	○	-	-	-	-	-	-
V Class (2015 >)	○	●	●	●	●	-	●

	1	2	3	4	5	6	7
MG Rover							
25 / Streetwise (1999 - 2005)	○	○	-	○	-	-	-
 GS (2016 >)	○	●	○	●	-	-	-
MG3 (2013 - 2015)	○	●	○	●	-	-	-
MG3 (2016 >)	○	●	○	●	-	-	-
MG6 (2011 - 2016)	○	●	○	●	-	-	-
 MG5 EV (2020 >)	○	●	○	●	-	-	-
 MG HS PHEV (2021 >)	○	●	○	●	-	-	-
 MG ZS (2021 >)	○	●	○	●	-	-	-
ZR (2001 - 2005)	○	○	○	○	-	-	-
ZT (2003 - 2006)	○	○	○	○	-	-	-
Mini							
Mini 3dr (1999 - 2006)	○	○	○	○	-	-	-
Mini (Cooper) Hatchback (2006-2014)	○	○	-	○	-	-	-
Mini (Cooper) Hatchback (2014 >)	●	●	-	●	-	-	-
Mini Coupe (2009 >)	○	-	-	-	-	-	-
Mini Countryman (2010 - 2017)	○	●	○	●	-	-	-
 Mini Countryman (2017 >)	●	●	○	●	-	-	-
Mini Paceman (2013 >)	○	●	-	●	-	-	-
Mini 5dr (2015 >)	●	●	○	●	-	-	-
Mitsubishi							
ASX (2010 >)	○	●	○	●	-	-	-
Colt (2007 - 2013)	○	●	○	●	-	-	-
Eclipse Cross (2019 >)	○	●	○	●	-	-	-
Lancer (2008 - 2011)	○	●	○	●	-	-	-





	1	2	3	4	5	6	7
Lancer Sportback (2008 - 2011)	○	●	○	●	-	-	-
Lancer Ralliart (2009 - 2011)	○	●	○	●	-	-	-
Mirage (2014 >)	○	●	○	●	-	-	-
Outlander (2007 - 2013)	○	●	○	●	-	-	-
Outlander (2013 >)	○	●	○	●	-	-	-
 Outlander PHEV (2015 >)	○	●	○	●	-	-	-
Shogun (2007 >)	○	●	○	●	-	-	-

Nissan







Juke (2010 >)	○	●	○	●	-	-	-
 Leaf (2011 >)	○	●	○	●	-	-	-
Micra (2011 - 2016)	○	●	○	●	-	-	-
 Micra (2017 >)	●	●	○	●	-	-	-
Murano (2016 >)	○	●	○	●	-	-	-
Note (2006 - 2013)	○	●	○	●	-	-	-
Note (2014 >)	○	●	○	●	-	-	-
Qashqai+2 (2008 - 2015)	○	●	○	●	○	-	○
Qashqai (2007 - 2013)	○	●	○	●	-	-	-
Qashqai (2014 >)	○	●	○	●	-	-	-
Quest MPV (2012 >)	○	●	-	●	○	-	○
Pulsar (2015 >)	○	●	○	●	-	-	-
X-Trail (2007 - 2015)	○	●	○	●	-	-	-
X-Trail (2015 >)	○	●	○	●	○	-	○



Opel



Adam (2013 >)	○	●	-	●	-	-	-
Agila (2008 >)	○	●	○	●	-	-	-

	1	2	3	4	5	6	7
 Ampera (2011 >)	○	●	-	●	-	-	-
Antara (2007 - 2015)	○	●	○	●	-	-	-
Astra (1998 - 2003)	○	○	○	○	-	-	-
Astra (2004 - 2010)	○	●	○	●	-	-	-
Astra 5dr (2010 >)	○	●	○	●	-	-	-
Astra Estate (2010 >)	○	●	○	●	-	-	-
Astra GTC (2011 >)	○	●	○	●	-	-	-
 Astra (2015 >)	○	●	○	●	-	-	-
Corsa D (2007 >)	○	●	○	●	-	-	-
Corsa 3dr Hatchback (2006 - 2015)	○	●	○	●	-	-	-
Corsa 5dr Hatchback (2006 - 2015)	○	●	○	●	-	-	-
Corsa 5dr(2015 >)	○	●	○	●	-	-	-
Corsa VXR (2007 >)	○	●	○	●	-	-	-
 Crossland X (2018 >)	○	●	○	●	-	-	-
 Grandland X (2018 >)	○	●	○	●	-	-	-
Insignia Hatchback (2009 >)	○	●	○	●	-	-	-
Insignia Saloon (2009 >)	○	●	○	●	-	-	-
Insignia Sports Tourer (2009 >)	○	●	○	●	-	-	-
 Insignia (2018 >)	○	●	○	●	-	-	-
Karl (2015 >)	○	●	○	●	-	-	-
Meriva (2010 >)	○	●	○	●	-	-	-
Mokka (2013 >)	○	●	○	●	-	-	-
Vectra (2005 - 2008)	○	●	○	●	-	-	-
Zafira (2005 - 2014)	○	●	○	●	○	-	○
Zafira Tourer (2014 >)	○	●	○	●	○	-	○

	1	2	3	4	5	6	7
Peugeot							
107 (2005 - 2014)	○	●	-	●	-	-	-
108 (2015 >)	○	●	-	●	-	-	-
206 3dr (2004 - 2009)	○	●	○	●	-	-	-
207 3dr (2006 - 2012)	○	●	○	●	-	-	-
207 5dr (2006 - 2012)	○	●	○	●	-	-	-
207 SW (2007 - 2012)	○	●	○	●	-	-	-
2008 (2013 >)	○	●	○	●	-	-	-
2008 (2020 >)	●	●	○	●	-	-	-
208 3dr (2013 >)	○	●	○	●	-	-	-
208 5dr (2013 >)	○	●	○	●	-	-	-
208 5dr (2020 >)	○	●	○	●	-	-	-
208 EV 5dr (2020 >)	●	●	○	●	-	-	-
307 (2001 - 2007)	○	●	○	●	-	-	-
307 Estate (2002 - 2007)	○	●	○	●	-	-	-
308 Hatchback (2007 - 2014)	○	●	○	●	-	-	-
308 SW (2008 - 2015)	○	●	○	●	-	-	-
308 SW (2015 >)	○	●	○	●	-	-	-
308 (2014 >)	○	●	○	●	-	-	-
SB! 3008 (2009 - 2016)	○	●	○	●	-	-	-
 3008 (2017 >)	●	●	○	●	-	-	-
407 (2004 - 2011)	○	●	○	●	-	-	-
407 SW (2004 - 2011)	○	●	○	●	-	-	-
4007 (2007 - 2012)	○	●	○	●	-	-	-
508 (2011 >)	○	●	○	●	-	-	-
508 SW/RXH (2011 >)	○	●	○	●	-	-	-







	1	2	3	4	5	6	7
 508 (2019 >)	●	●	○	●	-	-	-
SB! 5008 (2011 - 2018)	○	●	○	●	○	-	○
 SB! 5008 (2018 >)	○	●	○	●	○	-	○
Bipper (2008 >)	○	●	○	●	-	-	-
Expert Teepee (2007 - 2016)	○	●	○	●	○	○	○
Partner Combi (2004 - 2010)	○	●	○	●	-	-	-
Partner Teepee (2008 >)	○	●	○	●	-	-	-
RCZ (2011 >)	○	○	-	○	-	-	-
Traveller (2016 >)	○	●	○	●	●	●	●
Polestar							
 Polestar 2 (2020 >)	●	●	○	●	-	-	-
Porsche							
Cayenne (2011 - 2017)	○	●	○	●	-	-	-
 Cayenne E-Hybrid (2015 >)	○	●	○	●	-	-	-
 Cayenne (2017>)	○	●	○	●	-	-	-
Panamera (2011 >)	○	●	-	●	-	-	-
 Panamera E-Hybrid (2015 >)	○	●	-	●	-	-	-
Renault							
Captur (2015 >)	●	●	○	●	-	-	-
Clio (2005 - 2012)	○	●	○	●	-	-	-
Clio Renault Sport (2006 - 2012)	○	●	○	●	-	-	-
Clio Sport Tourer (2007 - 2012)	○	●	○	●	-	-	-
Clio (2013 >)	●	●	○	●	-	-	-

	1	2	3	4	5	6	7
Espace (2003 - 2012)	○	●	●	●	○	-	○
Grand Espace (2003 - 2012)	○	●	●	●	○	-	○
Kadjar (2015 >)	○	●	○	●	-	-	-
 Koleos (2018 >)	○	●	○	●	-	-	-
Laguna (2008 - 2012)	○	●	○	●	-	-	-
Laguna Sport Tourer (2008 - 2012)	○	●	○	●	-	-	-
Megane (2007)	○	●	○	●	-	-	-
Megane Hatchback (2002 - 2009)	○	●	○	●	-	-	-
SB! Megane Hatchback (2008-16)	○	●	○	●	-	-	-
Megane Sport Tourer (2009 - 2016)	○	●	○	●	-	-	-
 Megane (2016 >)	○	●	○	●	-	-	-
Modus (2004 - 2012)	○	●	○	●	-	-	-
Grand Modus (2008 - 2012)	○	●	○	●	-	-	-
SB! Scenic (2003 - 2009)	○	●	○	●	-	-	-
SB! Scenic (2009 - 2016)	○	●	○	●	○	-	○
 Scenic (2017 >)	●	●	○	●	-	-	-
Twingo (2007 - 2014)	○	●	-	●	-	-	-
Twingo (2015 >)	○	●	-	●	-	-	-
Saab							
9-3 (2002 - 2012)	○	●	○	●	-	-	-
9-3 Sport Wagon (2005 - 2012)	○	●	○	●	-	-	-
9-3 X (2009 - 2012)	○	●	○	●	-	-	-
9-5 Estate (2005 - 2010)	○	●	○	●	-	-	-
9-5 (2011-2012)	○	●	○	●	-	-	-

	1	2	3	4	5	6	7
Seat							
SB! Alhambra (2010 >)	○	●	●	●	○	-	○
Altea (2004 - 2011)	○	●	○	●	-	-	-
Altea XL (2007 - 2011)	○	●	○	●	-	-	-
Altea Freetrack4 (2007 - 2009)	○	●	○	●	-	-	-
Arosa (1997 - 2004)	○	○	-	○	-	-	-
 Arona (2018 >)	●	●	○	●	-	-	-
 Ateca (2018 >)	○	●	○	●	-	-	-
Exeo (2008 - 2014)	○	●	○	●	-	-	-
Exeo ST Estate (2008 - 2014)	○	●	○	●	-	-	-
Ibiza Cupra (2009 >)	○	●	○	●	-	-	-
Ibiza (2009 - 2017)	○	●	○	●	-	-	-
 Ibiza (2018 >)	○	●	○	●	-	-	-
Leon Cupra (2007 - 2011)	○	●	○	●	-	-	-
Leon (1998 - 2004)	○	●	○	●	-	-	-
Leon (2005 - 2012)	○	●	○	●	-	-	-
Leon (2013 >)	○	●	○	●	-	-	-
Mii (2011 >)	○	●	○	●	-	-	-
Toledo (2013 >)	○	●	○	●	-	-	-

Skoda

Citigo (2012 >)	○	●	○	●	-	-	-
Fabia (2007 - 2014)	○	●	○	●	-	-	-
Fabia Combi (2008 - 2014)	○	●	○	●	-	-	-
Fabia (2015 - 2020)	○	●	○	●	-	-	-
 Fabia (2021 >)	○	●	○	●	-	-	-

	1	2	3	4	5	6	7
 Kamiq (2020 >)	●	●	○	●	-	-	-
 Karoq (2018 >)	○	●	○	●	-	-	-
Kodiaq (2017 >)	○	●	○	●	○	-	○
Octavia (2004 - 2013)	○	●	○	●	-	-	-
Octavia (2013 - 2020)	○	●	○	●	-	-	-
 Octavia (2020 >)	○	●	○	●	-	-	-
Rapid (2013 >)	○	●	○	●	-	-	-
Roomster (2006 >)	○	●	○	●	-	-	-
 Scala (2020 >)	○	●	○	●	-	-	-
Superb Combi Estate (2008 >)	○	●	○	●	-	-	-
Superb (2008 - 2014 >)	○	●	○	●	-	-	-
 Superb (2015 >)	○	●	○	●	-	-	-
Yeti (2009 - 2017)	○	●	○	●	-	-	-
 ⚡ Enyaq EV (2021>)	●	●	○	●	-	-	-
Smart							
For Two Coupe (2007 >)	○	-	-	-	-	-	-
FourFour (2015 >)	○	●	-	●	-	-	-
Ssangyong							
Actyon (2006 - 2011)	○	●	○	●	-	-	-
Korando (2011 >)	○	●	○	●	-	-	-
Musso Pickup (2016 >)	○	●	○	●	-	-	-
Rexton (2014 >)	○	●	○	●	-	-	-
Tivoli (2016 >)	○	●	○	●	-	-	-
Turismo (2014 >)	○	●	○	●	○	○	○

1 2 3 4 5 6 7

Suzuki





 Across (2020 >)	○	●	○	●	-	-	-
Alto (2009 >)	○	●	-	●	-	-	-
 Baleno (2016 >)	○	●	○	●	-	-	-
Grand Vitara (2006 >)	○	●	○	●	-	-	-
Vitara (2015 >)	○	●	○	●	-	-	-
Splash (2008 >)	○	●	○	●	-	-	-
Swift Sport (2011 - 2017)	○	●	○	●	-	-	-
SX - 4 (2006 >)	○	●	○	●	-	-	-
 Ignis (2016 >)	○	●	○	●	-	-	-
 Swift (2017 >)	○	●	○	●	-	-	-



Subaru

BRZ (2012 >)	○	○	-	○	-	-	-
Forester (2013 >)	○	●	○	●	-	-	-
Impreza 5dr (2007 - 2012)	○	●	○	●	-	-	-
Impreza 5 Door (2013 >)	○	●	○	●	-	-	-
Legacy (2012 >)	○	●	○	●	-	-	-
Outback (2012 >)	○	●	○	●	-	-	-
XV Hatchback (2011 >)	○	●	○	●	-	-	-



Tesla

 Model S (2014 >)	○	●	○	●	-	-	-
 Model X (2016 >)	○	●	○	●	○	-	○
  Model 3 (2019 >)	○	●	○	●	-	-	-

	1	2	3	4	5	6	7
Toyota							
Auris (2007 - 2012)	○	●	○	●	-	-	-
Auris (2013 >)	○	●	○	●	-	-	-
Avensis Hatchback (2003 - 2011)	○	●	○	●	-	-	-
Avensis Tourer (2009 >)	○	●	○	●	-	-	-
Aygo (2005 - 2014)	○	●	-	●	-	-	-
Aygo (2014 - 2019)	○	●	-	●	-	-	-
 Aygo (2019 >)	○	●	-	●	-	-	-
 Aygo X (2021 >)	○	●	○	●	-	-	-
 Corolla (2018 >)	○	●	○	●	-	-	-
C-HR (2017 >)	○	●	○	●	-	-	-
EZ MPV (2013 >)	○	●	○	●	-	-	-
GT86 (2012 >)	○	○	-	○	-	-	-
Highlander (2013 >)	○	●	○	●	-	-	-
 ⚡ Highlander (2021 >)	○	●	○	●	○	-	○
Land Cruiser (2003 - 2009)	○	●	○	●	-	-	-
Land Cruiser (2009 >)	○	●	○	●	-	-	-
⚡ Prius (2004 - 2010)	○	●	○	●	-	-	-
⚡ Prius (2010 >)	○	●	○	●	-	-	-
⚡ Prius PHEV (2015 >)	○	●	○	●	-	-	-
⚡ Prius Plus + (2012 >)	○	●	○	●	-	-	-
Prius 4 (2016 >)	○	●	○	●	-	-	-
Rav 4 MK3 (2006 - 2011)	○	●	○	●	-	-	-
RAV4 (2013 - 2019)	○	●	○	●	-	-	-
⚡ RAV4 Hybrid (2014 - 2019)	○	●	○	●	-	-	-
 ⚡ RAV4 (2019 >)	○	●	○	●	-	-	-



	1	2	3	4	5	6	7
SBI Verso (2009 - 2012)	○	●	○	●	-	-	-
SBI Verso (2013 >)	○	●	○	●	-	-	-
Yaris (2008 - 2011)	○	●	○	●	-	-	-
Yaris (2011 - 2017)	○	●	○	●	-	-	-
 Yaris (2019 >)	○	●	○	●	-	-	-
 Yaris Cross (2021 >)	○	●	○	●	-	-	-











Vauxhall

Adam (2013 >)	○	●	-	●	-	-	-
Agila (2008 >)	○	●	○	●	-	-	-
Ampera (2011)	○	●	-	●	-	-	-
Antara (2007 - 2015)	○	●	○	●	-	-	-
Astra (1998 - 2003)	○	○	○	○	-	-	-
Astra (2004 - 2010)	○	●	○	●	-	-	-
Astra 5dr (2010 >)	○	●	○	●	-	-	-
Astra Estate (2010 >)	○	●	○	●	-	-	-
Astra GTC (2011 >)	○	●	○	●	-	-	-
 Astra (2015 >)	○	●	○	●	-	-	-
Corsa D (2007 >)	○	●	○	●	-	-	-
Corsa 3dr Hatchback (2006 - 2015)	○	●	○	●	-	-	-
Corsa 5dr Hatchback (2006 - 2015)	○	●	○	●	-	-	-
Corsa 5dr (2015 >)	○	●	○	●	-	-	-
Corsa VXR (2007 >)	○	●	○	●	-	-	-
 Crossland X (2018 >)	○	●	○	●	-	-	-
 Grandland X (2018 >)	○	●	○	●	-	-	-
Insignia Hatchback (2009 >)	○	●	○	●	-	-	-

	1	2	3	4	5	6	7
Insignia Saloon (2009 >)	○	●	○	●	-	-	-
Insignia Sports Tourer (2009 >)	○	●	○	●	-	-	-
 Insignia (2018 >)	○	●	○	●	-	-	-
Meriva (2010 >)	○	●	○	●	-	-	-
Mokka (2013 >)	○	●	○	●	-	-	-
Vectra (2005 - 2008)	○	●	○	●	-	-	-
Viva (2015 >)	○	●	○	●	-	-	-
Zafira (2005 - 2014)	○	●	○	●	○	-	○
Zafira Tourer (2012 >)	○	●	○	●	○	-	○







Volkswagen

 Arteon (2017 >)	○	●	○	●	-	-	-
Beetle (1999 - 2005)	○	○	○	○	-	-	-
Beetle (2012 >)	○	●	-	●	-	-	-
Caddy (2010 >)	○	●	○	●	○	○	○
Caddy Maxilife (2010 - 2015)	○	●	○	●	○	○	○
Multivan Caravelle (2008 >)	○	●	-	●	●	○	●
Golf Mk5 (2004 - 2009)	○	●	○	●	-	-	-
Golf Cabriolet (2009 - 2014)	○	○	○	○	-	-	-
Golf Plus (2009 - 2012)	○	●	○	●	-	-	-
Golf Mk6 (2008 - 2012)	○	●	○	●	-	-	-
Golf Mk7 (2012 >)	○	●	○	●	-	-	-
 ID3 EV (2020 >)	●	●	○	●	-	-	-
 ID4 EV (2021 >)	●	●	○	●	-	-	-
Jetta (2011 >)	○	●	○	●	-	-	-
Lupo (1999 - 2005)	○	○	-	○	-	-	-

	1	2	3	4	5	6	7
Passat (2005 - 2010)	○	●	○	●	-	-	-
Passat (2010 - 2015)	○	●	○	●	-	-	-
 Passat Saloon (2015 >)	○	●	○	●	-	-	-
Passat Alltrack (2012 >)	○	●	○	●	-	-	-
Passat CC (2008 >)	○	●	○	●	-	-	-
Passat Estate (2005 -2011)	○	●	○	●	-	-	-
Passat Estate (2011 - 2015)	○	●	○	●	-	-	-
 Passat Estate (2015 >)	○	●	○	●	-	-	-
Polo (2009 - 2017)	○	●	○	●	-	-	-
 Polo (2017 >)	○	●	○	●	-	-	-
Scirocco (2011)	○	●	-	●	-	-	-
SB! Sharan (2010 >)	○	●	●	●	○	-	○
Tiguan (2008 - 2016)	○	●	○	●	-	-	-
 Tiguan (2016 >)	○	●	○	●	-	-	-
 Tiguan Allspace (2017 >)	○	●	○	●	○	-	○
Touareg (2003 - 2009)	○	●	○	●	-	-	-
Touareg (2010 - 2018)	○	●	○	●	-	-	-
 Touareg (2018 >)	○	●	○	●	-	-	-
 T-Cross (2019 >)	●	●	○	●	-	-	-
 T-Roc (2017 >)	○	●	○	●	-	-	-
SB! Touran (2010 - 2015)	○	●	○	●	○	-	○
 Touran (2016 >)	○	●	●	●	●	-	●
UP! (2012 >)	○	●	○	●	-	-	-
 E - UP! (2014 >)	○	●	○	●	-	-	-

Volvo

C30 (2007 - 2013)	○	●	-	●	-	-	-
-------------------	---	---	---	---	---	---	---





	1	2	3	4	5	6	7
S40 (2004 - 2012)	○	●	○	●	-	-	-
S60 (2010 >)	○	●	○	●	-	-	-
S80 (2007 >)	○	●	○	●	-	-	-
 S90 (2016 >)	○	●	○	●	-	-	-
V40 (2012 >)	○	●	○	●	-	-	-
V40 Cross Country (2013 >)	○	●	○	●	-	-	-
V50 (2004 - 2012)	○	●	○	●	-	-	-
V60 (2011 - 2017)	○	●	○	●	-	-	-
 V60 PHEV (2015 - 2018)	○	●	○	●	-	-	-
 V60 (2018 >)	○	●	○	●	-	-	-
V70 (2008 >)	○	●	○	●	-	-	-
 V90 (2016 >)	○	●	○	●	-	-	-
 XC40 (2018 >)	○	●	○	●	-	-	-
XC60 (2008 - 2017)	○	●	○	●	-	-	-
 XC60 (2017 >)	○	●	○	●	-	-	-
XC70 (2008 >)	○	●	○	●	-	-	-
XC90 (2003 - 2014)	○	●	○	●	○	-	○
 XC90 (2016 >)	○	●	○	●	○	-	○





1 2 3 4 5 6 7

Alfa Romeo

Guilietta (2010 >)	○	●	○	●	-	-	-
Giulia (2017 >)	●	●	○	●	-	-	-
Mito (2009 >)	○	●	-	●	-	-	-
Stelvio (2017 >)	○	●	○	●	-	-	-



Audi

A1 (2011 - 2019)	●	●	○	●	-	-	-
A1 Sportback (2012 - 2019)	●	●	○	●	-	-	-
 A1 (2019 >)	●	●	○	●	-	-	-
A3 Hatchback (2012 >)	●	●	○	●	-	-	-
A3 (1996 - 2003)	○	●	○	●	-	-	-
A3 (2004 - 2011)	○	●	○	●	-	-	-
A3/S3 (2012 >)	●	●	○	●	-	-	-
⚡ A3 e-Tron Sportback (2015 >)	●	●	○	●	-	-	-
A3 Saloon (2014 >)	●	●	○	●	-	-	-
A4 (2005 - 2008)	○	●	○	●	-	-	-
 A4 (2016 >)	●	●	○	●	-	-	-
 A4 Avant (2016 >)	●	●	○	●	-	-	-
A4 Allroad (2008 - 2016)	●	●	○	●	-	-	-
A4/S4 Avant (2008 - 2016)	●	●	○	●	-	-	-
A4/S4 Saloon (2008 - 2016)	●	●	○	●	-	-	-
A5/S5 Coupe (2016 >)	●	●	-	●	-	-	-
A5/S5 Coupe (2006 - 2016)	●	●	-	●	-	-	-
A5/S5 Sportback (2009 - 2016)	●	●	○	●	-	-	-
A5/S5 Sportback (2017 >)	●	●	○	●	-	-	-
 Audi A5/S5 Cabriolet (2017 >)	●	●	-	●	-	-	-



	1	2	3	4	5	6	7
A6 Allroad (2011 - 2016)	●	●	○	●	-	-	-
A6/S6 Avant (2011 - 2016)	●	●	○	●	-	-	-
A6/S6 (2011 - 2016)	●	●	○	●	-	-	-
A6/S6 (2016 >)	●	●	○	●	-	-	-
A6 Allroad (2016 >)	●	●	○	●	-	-	-
A7 Sportback (2011 - 2015)	●	●	○	●	-	-	-
A7/S7 Sportback (2016 - 2018)	●	●	○	●	-	-	-
A7/S7 Sportback (2018 >)	●	●	○	●	-	-	-
 A8/S8 (2018 >)	●	●	○	●	-	-	-
A8/S8 (2011 - 2017)	●	●	○	●	-	-	-
 Q2 (2016 >)	●	●	○	●	-	-	-
Q3/SQ3 (2013 - 2018)	●	●	○	●	-	-	-
 Q3/SQ3 (2019 >)	●	●	○	●	-	-	-
Q5/SQ5 (2008 - 2012)	●	●	○	●	-	-	-
Q5/SQ5 (2012 - 2016)	●	●	○	●	-	-	-
Q5/SQ5 (2017 >)	●	●	○	●	-	-	-
Q7 (2006 - 2014)	●	●	○	●	○	-	○
 Q7/SQ7 (2015 >)	●	●	○	●	○	-	○
 Q8 (2018 >)	●	●	○	●	-	-	-
TT Coupe (2006 - 2017)	●	○	-	○	-	-	-
TT Coupe (2017 >)	●	○	-	○	-	-	-

Bentley

Continental GT (2003 - 2012)	●	○	-	○	-	-	-
Continental Flying Spur (2005-2012)	●	●	○	●	-	-	-
Continental GTC (2006 - 2012)	●	○	-	○	-	-	-
Mulsanne (2010 >)	●	●	○	●	-	-	-

	1	2	3	4	5	6	7
BMW							
1-Series (2004 - 2011)	○	●	○	●	-	-	-
1 Series Convertible (2008 - 2015)	●	●	-	●	-	-	-
1 Series Coupe (2008 - 2015)	●	●	-	●	-	-	-
1 Series F20 (2011 >)	●	●	○	●	-	-	-
2 Series Active Tourer (2015 >)	●	●	○	●	-	-	-
2 Series Coupe (2014 >)	●	●	-	●	-	-	-
3 Series (2002 - 2005)	○	●	○	●	-	-	-
3 Series (2005 - 2011)	○	●	○	●	-	-	-
3 Series Coupe (2007 - 2014)	●	●	-	●	-	-	-
3 Series F30 (2012 >)	●	●	○	●	-	-	-
4 Series GC (2014 >)	●	●	○	●	-	-	-
5 Series Saloon (2003 - 2008)	○	●	○	●	-	-	-
5 Series Touring (2003 - 2008)	○	●	○	●	-	-	-
5 Series (2008 - 2010)	●	●	○	●	-	-	-
5 Series Touring (2011 -2018)	●	●	○	●	-	-	-
5 Series Saloon (2011 - 2018)	●	●	○	●	-	-	-
5 Series (2011 - 2018)	●	●	○	●	-	-	-
 5 Series (2018 >)	●	●	○	●	-	-	-
6 Series Coupe (2011 >)	●	●	-	●	-	-	-
6 Series Convertible (2011 >)	●	●	-	●	-	-	-
6 Series Gran Coupe (2011 >)	●	●	○	●	-	-	-
7 Series (2010 - 2016)	●	●	○	●	-	-	-
7 Series (2016 >)	●	●	○	●	-	-	-
 i3 (2014 >)	●	●	○	●	-	-	-
i8 (2014 >)	●	○	-	○	-	-	-
X1 (2010 - 2015)	●	●	○	●	-	-	-

1 2 3 4 5 6 7

 X1 (2016 >)	●	●	○	●	-	-	-
X3 F25 (2011 - 2018)	●	●	○	●	-	-	-
X3 G01 (2018 >)	●	●	○	●	-	-	-
 X4 (2014 >)	●	●	○	●	-	-	-
X5 (2007 - 2014)	●	●	○	●	○	-	○
X5 (2015 >)	●	●	○	●	○	-	○
X6 (2008 >)	●	●	○	●	-	-	-
X6 (2015 >)	●	●	○	●	-	-	-
3-GT (2013 >)	●	●	○	●	-	-	-
5-GT (2010 >)	●	●	○	●	-	-	-

Cadillac

BLS Saloon (2006 - 2011)	●	●	○	●	-	-	-
--------------------------	---	---	---	---	---	---	---

Chevrolet





Aveo (2012 >)	○	●	○	●	-	-	-
Captiva (2007 >)	●	●	○	●	○	-	○
Cruze (2009 >)	●	●	○	●	-	-	-
Spark (2012 >)	○	●	○	●	-	-	-
Volt (2011 >)	●	●	-	●	-	-	-
Orlando (2011 >)	●	●	○	●	○	-	○
Traxx (2013 >)	●	●	○	●	-	-	-





Chrysler











Grand Voyager (2008 >)	●	●	-	●	○	○	○
300 C (2012 >)	○	●	○	●	-	-	-
Delta (2011 >)	○	●	○	●	-	-	-
Ypsilon (2011 >)	○	●	○	●	-	-	-







1 2 3 4 5 6 7





Citroen

SB! Citroen Berlingo II (2008 >)	●	●	○	●	-	-	-
SB! Berlingo Multispace (2007 >)	●	●	○	●	○	-	○
C1 (2006 - 2015)	●	●	-	●	-	-	-
C1 (2015 >)	●	●	-	●	-	-	-
C3 (2005 - 2009)	●	●	○	●	-	-	-
C3 5 Door (2009 >)	●	●	○	●	-	-	-
SB! C3 Picasso (2009 >)	●	●	○	●	-	-	-
C3 (2017 >)	●	●	○	●	-	-	-
 C3 Aircross (2017 >)	●	●	○	●	-	-	-
C4 (2010 >)	●	●	○	●	-	-	-
SB! C4 Picasso (2007 - 2014)	●	●	●	●	○	-	○
SB! C4 Picasso (2014 >)	●	●	●	●	○	-	○
SB! C4 G-Picasso (2007 - 2013)	●	●	●	●	○	-	○
C5 (2006 - 2008)	○	●	○	●	-	-	-
C5 Saloon (2008 >)	○	●	○	●	-	-	-
C5 Tourer (2008 >)	○	●	○	●	-	-	-
 C4-Cactus (2015 >)	●	●	○	●	-	-	-
C-Crosser (2007 - 2012)	●	●	○	●	-	-	-
 C5 Aircross (2019 >)	●	●	○	●	-	-	-
DS3 (2011 >)	●	●	○	●	-	-	-
 DS3 Crossback (2019 >)	●	●	○	●	-	-	-
DS4 (2011 >)	●	●	○	●	-	-	-
DS5 (2013 >)	●	●	○	●	-	-	-
 DS7 (2018 >)	●	●	○	●	-	-	-
Jumpy (2007 - 2012)	○	●	○	●	●	○	●
Nemo (2008 >)	○	●	○	●	-	-	-

		1	2	3	4	5	6	7
Dacia	Xsara (2000 - 2006)	○	●	○	●	-	-	-
	Duster (2012 >)	●	●	○	●	-	-	-
	Logan MCV (2013 >)	○	●	○	●	-	-	-
	Sandero (2013 >)	○	●	○	●	-	-	-
Fiat	124 Spider (2016 >)	●	-	-	-	-	-	-
	500 (2008 >)	○	●	-	●	-	-	-
	500 C (2009 >)	○	●	-	●	-	-	-
	Abarth 500 (2009 >)	○	●	-	●	-	-	-
	Bravo (2007 >)	○	●	○	●	-	-	-
	500L (2013 >)	●	●	○	●	-	-	-
	 500X (2015 >)	●	●	○	●	-	-	-
	Doblo (2010 >)	●	●	○	●	-	-	-
	Panda (2012 >)	○	●	○	●	-	-	-
	Grande Punto (2006 >)	○	●	○	●	-	-	-
	Abarth Grande Punto (2008 - 2011)	○	●	○	●	-	-	-
	Qubo (2008 >)	○	●	○	●	-	-	-
 Tipo (2016 >)	○	●	○	●	-	-	-	
Ford	 B Max (2012 >)	●	●	○	●	-	-	-
	SB! Focus C Max (2003 - 2010)	○	●	○	●	-	-	-
	C Max (2010 -2012)	○	●	○	●	-	-	-
	 C Max (2013 >)	○	●	○	●	-	-	-
	 Edge (2016 >)	○	●	○	●	○	-	○

	1	2	3	4	5	6	7
Fiesta (2004 - 2008)	○	●	○	●	-	-	-
Fiesta (2008 - 2017)	○	●	○	●	-	-	-
 Fiesta (2017 >)	○	●	○	●	-	-	-
Focus (1998 - 2005)	○	●	○	●	-	-	-
Focus (2005 - 2009)	○	●	○	●	-	-	-
Focus (2010 - 2015)	○	●	○	●	-	-	-
 Focus (2015 - 2018)	○	●	○	●	-	-	-
 Focus Electric (2015 >)	○	●	○	●	-	-	-
 Focus (2018 >)	●	●	○	●	-	-	-
SB! Galaxy (2006 - 2015 >)	○	●	○	●	○	-	○
 Galaxy (2016 >)	○	●	○	●	○	-	○
KA (2009 - 2016)	○	●	-	●	-	-	-
 KA+ (2016 >)	●	●	○	●	-	-	-
Kuga (2008 - 2012)	○	●	○	●	-	-	-
Kuga (2013 >)	○	●	○	●	-	-	-
 Kuga (2020 >)	●	●	○	●	-	-	-
Mondeo (2002 - 2007)	○	●	○	●	-	-	-
Mondeo Estate (2007 - 2014)	○	●	○	●	-	-	-
Mondeo Hatchback (2007 - 2014)	○	●	○	●	-	-	-
Mondeo Saloon (2007 - 2014)	○	●	○	●	-	-	-
 Mondeo (2014 >)	○	●	○	●	-	-	-
 Puma (2020 >)	○	●	○	●	-	-	-
Ranger Double-Cab Pickup (2019 >)	○	●	○	●	-	-	-
SB! S Max (2006 - 2015 >)	○	●	○	●	○	-	○
 S Max (2016 >)	○	●	○	●	○	-	○
 EcoSport (2015 >)	○	●	○	●	-	-	-

	1	2	3	4	5	6	7
Honda							
Accord Saloon (2008 >)	●	●	○	●	-	-	-
Accord Tourer (2008 >)	●	●	○	●	-	-	-
Civic (2012 - 2018)	○	●	○	●	-	-	-
Civic (2006 - 2011)	○	●	○	●	-	-	-
Civic Hybrid Saloon (2006 - 2010)	○	●	○	●	-	-	-
Civic Type R (2007 - 2010)	○	●	○	●	-	-	-
Civic Tourer (2014 >)	○	●	○	●	-	-	-
 Civic (2018 >)	●	●	○	●	-	-	-
CRV (2007 - 2013)	○	●	○	●	-	-	-
CRV (2012 >)	○	●	○	●	-	-	-
 CRV (2019 >)	●	●	○	●	○	-	○
 Honda E (2021 >)	○	●	○	●	-	-	-
Elysion (2012 >)	○	●	○	●	○	-	○
FRV (2006 - 2011)	○	●	○	●	-	-	-
 HR-V (2015 >)	●	●	○	●	-	-	-
Insight (2009 >)	○	●	○	●	-	-	-
Jazz (2002 - 2008)	○	●	○	●	-	-	-
Jazz (2008 - 2015)	○	●	○	●	-	-	-
 Jazz (2016 >)	●	●	○	●	-	-	-
 Jazz /Crosstar (2020 >)	●	●	○	●	-	-	-
Legend (2006 - 2010)	○	●	○	●	-	-	-
Odyssey (2010 >)	○	●	-	●	-	-	-
Hyundai							
Getz (2005 - 2011)	○	●	○	●	-	-	-





	1	2	3	4	5	6	7
i10 Hatchback (2008 >)	●	●	○	●	-	-	-
i20 Hatchback (2009 >)	●	●	○	●	-	-	-
i20 (2015 >)	●	●	○	●	-	-	-
i30 (2012 - 2015)	●	●	○	●	-	-	-
i30 (2015 >)	●	●	○	●	-	-	-
i40 (2011 >)	●	●	○	●	-	-	-
iX20 (2011 >)	●	●	○	●	-	-	-
iX35 (2010 >)	●	●	○	●	-	-	-
i800/H1 (2008 >)	○	●	●	●	●	○	●
 Ioniq (2016 >)	●	●	○	●	-	-	-
 Kona (2017 >)	●	●	○	●	-	-	-
Santa Fe (2007 - 2012)	●	●	○	●	○	-	○
Santa Fe (2012 >)	●	●	○	●	○	-	○
Tucson (2010 >)	●	●	○	●	-	-	-
 Tucson (2015 >)	●	●	○	●	-	-	-
Veloster (2012 >)	●	○	-	○	-	-	-
 Genesis G80 (2021>)	●	●	○	●	-	-	-
 Genesis GV80 (2021>)	●	●	○	●	○	-	○

Infiniti

EX (2009 >)	○	●	○	●	-	-	-
FX (2009 >)	●	●	○	●	-	-	-
G Coupe (2009 >)	○	○	○	○	-	-	-
G Saloon (2009 >)	●	●	○	●	-	-	-
M (2010 >)	●	●	○	●	-	-	-

Jaguar



E-Pace (2018 >)	○	●	○	●	-	-	-
-----------------	---	---	---	---	---	---	---









	1	2	3	4	5	6	7
 F - Pace (2016 >)	○	●	○	●	-	-	-
F-Type Coupe (2014 >)	○	-	-	-	-	-	-
 I - Pace (2018 >)	○	●	○	●	-	-	-
X-Type (2001 - 2010)	○	●	○	●	-	-	-
X-Type Estate (2004 - 2010)	○	●	○	●	-	-	-
 XE (2015 >)	●	●	○	●	-	-	-
XF (2008 - 2014)	○	●	○	●	-	-	-
 XF (2015 >)	●	●	○	●	-	-	-
XF R (2009 - 2015)	○	●	○	●	-	-	-
XF Sportbrake (2013 >)	○	●	○	●	-	-	-
XJ (2010 >)	○	●	○	●	-	-	-
XK (2006 - 2016)	○	●	-	●	-	-	-
! XK Coupe (2006 - 2016)	○	○	-	○	-	-	-
XK Convertible (2006 - 2016)	○	○	-	○	-	-	-

Jeep



Grand Cherokee (2011 >)	○	●	○	●	-	-	-
Compass (2011 >)	○	●	○	●	-	-	-
Cherokee (2014 >)	○	●	○	●	-	-	-
 Renegade (2015 >)	●	●	○	●	-	-	-
Wrangler 5dr (2007 >)	○	●	○	●	-	-	-

Kia

SB! Carens (2013 >)	●	●	○	●	○	-	○
Ceed Hatchback (2012 >)	○	●	○	●	-	-	-
 Ceed/XCeed (2020 >)	●	●	○	●	-	-	-
 EV6 (2022 >)	●	●	○	●	-	-	-

	1	2	3	4	5	6	7
 ProCeed (2020 >)	●	●	○	●	-	-	-
 Niro (2017 >)	●	●	○	●	-	-	-
Optima (2011 - 2015)	●	●	○	●	-	-	-
 Optima (2016 >)	●	●	○	●	-	-	-
Picanto (2008 - 2011)	○	●	○	●	-	-	-
Picanto (2011 - 2017)	○	●	○	●	-	-	-
 Picanto (2018 >)	○	●	○	●	-	-	-
Rio (2012 - 2017)	○	●	○	●	-	-	-
 Rio (2017 >)	●	●	○	●	-	-	-
Sorento (2003- 2009)	○	●	○	●	-	-	-
Sorento (2010 - 2014)	○	●	○	●	-	-	-
Sorento (2015 >)	○	●	○	●	●	-	●
 Sorento (2020 >)	●	●	○	●	●	-	●
Soul (2009 >)	○	●	○	●	-	-	-
 Soul EV (2015 >)	○	●	○	●	-	-	-
Sportage (2011 - 2015)	○	●	○	●	-	-	-
 Sportage (2016 >)	○	●	○	●	-	-	-
 Stonic (2016 >)	●	●	○	●	-	-	-
Venga (2010 >)	○	●	○	●	-	-	-

Land Rover

 Defender (2020 >)	●	●	○	●	●	-	●
Discovery Sport (2015 >)	●	●	○	●	○	-	○
Discovery 4 (2009 >)	○	●	○	●	○	-	○
 Discovery 5 (2018 >)	●	●	○	●	●	-	●
Freelander 2 (2006 >)	○	●	○	●	-	-	-
Range Rover (2013 >)	●	●	○	●	-	-	-





1 2 3 4 5 6 7

Range Rover (2002 - 2012)	●	●	○	●	-	-	-
Range Rover Sport (2005 - 2012)	●	●	○	●	-	-	-
Range Rover Sport (2013 >)	○	●	○	●	○	-	○
Range Rover Evoque 3dr (2011 >)	○	●	○	●	-	-	-
Range Rover Evoque 5dr (2011 >)	○	●	○	●	-	-	-
 Range Rover Evoque (2019 >)	○	●	○	●	-	-	-
 Range Rover Velar (2017 >)	○	●	○	●	-	-	-

Lancia



Thema (2012 >)	○	●	○	●	-	-	-
Voyager (2010 >)	●	●	○	●	○	-	○
Delta (2011 >)	○	●	○	●	-	-	-
Ypsilon (2012 >)	○	●	○	●	-	-	-

Lexus



CT (2011 >)	●	●	○	●	-	-	-
GS (2013 >)	●	●	○	●	-	-	-
 GSh (2013 >)	●	●	○	●	-	-	-
IS Saloon (2005 - 2012)	○	●	○	●	-	-	-
 NX (2014 >)	●	●	○	●	-	-	-
 ES Hybrid (2019 >)	●	●	○	●	-	-	-
 UX (2019 >)	●	●	○	●	-	-	-
RX (2010 - 2018)	●	●	○	●	-	-	-
 RX (2018 >)	●	●	○	●	○	-	○







Mazda





 CX-3 (2015 >)	●	●	○	●	-	-	-
CX-5 (2011 >)	○	●	○	●	-	-	-

	1	2	3	4	5	6	7
CX-7 (2007 - 2011)	○	●	○	●	-	-	-
Mazda 2 (2009 - 2015)	○	●	○	●	-	-	-
 Mazda 2 (2015 >)	●	●	○	●	-	-	-
3 Hatchback (2009 - 2013)	○	●	○	●	-	-	-
3 Saloon (2009 - 2013)	○	●	○	●	-	-	-
3 Hatchback (2014 >)	●	●	○	●	-	-	-
5 (2005 - 2010)	○	●	○	●	-	-	-
6 Estate (2008 - 2012)	○	●	○	●	-	-	-
6 Hatchback (2007 - 2012)	○	●	○	●	-	-	-
6 Saloon (2007 - 2009)	○	●	○	●	-	-	-
6 (2013 - 2017)	○	●	○	●	-	-	-
 6 (2018 >)	●	●	○	●	-	-	-
MX-5 (2015 >)	●	-	-	-	-	-	-

Mercedes-Benz



A Class (2005 - 2012)	○	●	○	●	-	-	-
A Class (2013 >)	○	●	○	●	-	-	-
 A Class (2019 >)	○	●	○	●	-	-	-
A Class Saloon (2020 >)	○	●	○	●	-	-	-
B Class (2012 >)	○	●	○	●	-	-	-
 B Class EV (2015 >)	○	●	○	●	-	-	-
C Class (2008 - 2015)	○	●	○	●	-	-	-
C Class Estate (2008 - 2015)	○	●	○	●	-	-	-
C Class Coupe (2011 >)	○	●	-	●	-	-	-
C Class (2015 >)	○	●	○	●	-	-	-
CLA (2013 >)	○	●	○	●	-	-	-
 CLA (2020 >)	○	●	○	●	-	-	-

	1	2	3	4	5	6	7
 CLA Shooting Brake (2015 >)	○	●	○	●	-	-	-
CLS Shooting Brake (2012 >)	○	●	○	●	-	-	-
CLS Coupe (2011 >)	○	●	○	●	-	-	-
E Class (2006 - 2009)	○	●	○	●	-	-	-
E Class Saloon (2009 - 2012)	○	●	○	●	-	-	-
E Class Coupe (2009 >)	○	●	-	●	-	-	-
E Class (2013 - 2018)	○	●	○	●	-	-	-
 E Class (2018 >)	○	●	○	●	-	-	-
 EQA (2021 >)	○	●	○	●	-	-	-
 EQC (2021 >)	○	●	○	●	-	-	-
 GLA (2021 >)	○	●	○	●	-	-	-
GLA (2014 - 2020)	○	●	○	●	-	-	-
 GLC (2016 >)	○	●	○	●	-	-	-
GLC Coupe (2019 >)	○	●	○	●	-	-	-
GL Class (2006 - 2012)	○	●	○	●	○	-	○
GL/GLS Class (2012 >)	○	●	○	●	●	-	●
GLE (2015 - 2020)	○	●	○	●	-	-	-
 GLE (2020 >)	○	●	○	●	○	-	○
M/ML Class (2005 - 2012)	○	●	○	●	-	-	-
M/ML Class (2012 >)	○	●	○	●	-	-	-
R Class (2006 - 2012)	○	●	○	●	○	-	○
S Class (2006 - 2013)	○	●	○	●	-	-	-
S Class (2015 >)	○	●	○	●	-	-	-
SL Class (2012 >)	○	-	-	-	-	-	-
SLK (2011 >)	○	-	-	-	-	-	-
V Class (2015 >)	○	●	●	●	●	-	●

	1	2	3	4	5	6	7
MG Rover							
25 / Streetwise (1999 - 2005)	○	○	-	○	-	-	-
 GS (2016 >)	●	●	○	●	-	-	-
MG3 (2013 - 2015)	○	●	○	●	-	-	-
MG3 (2016 >)	○	●	○	●	-	-	-
MG6 (2011 - 2016)	○	●	○	●	-	-	-
 MG5 EV (2020 >)	○	●	○	●	-	-	-
 MG HS PHEV (2021 >)	○	●	○	●	-	-	-
 MG ZS (2021 >)	○	●	○	●	-	-	-
ZR (2001 - 2005)	○	○	○	○	-	-	-
ZT (2003 - 2006)	○	●	○	●	-	-	-
Mini							
Mini 3dr (1999 - 2006)	○	○	○	○	-	-	-
Mini (Cooper) Hatchback (2006-2014)	○	●	-	●	-	-	-
Mini (Cooper) Hatchback (2014 >)	●	●	-	●	-	-	-
Mini Coupe (2009 >)	○	-	-	-	-	-	-
Mini Countryman (2010 - 2017)	○	●	○	●	-	-	-
 Mini Countryman (2017 >)	●	●	○	●	-	-	-
Mini Paceman (2013 >)	○	●	-	●	-	-	-
Mini 5dr (2015 >)	●	●	○	●	-	-	-
Mitsubishi							
ASX (2010 >)	○	●	○	●	-	-	-
Colt (2007 - 2013)	○	●	○	●	-	-	-
Eclipse Cross (2019 >)	○	●	○	●	-	-	-





	1	2	3	4	5	6	7
Lancer (2008 - 2011)	○	●	○	●	-	-	-
Lancer Sportback (2008 - 2011)	○	●	○	●	-	-	-
Lancer Ralliart (2009 - 2011)	○	●	○	●	-	-	-
Mirage (2014 >)	○	●	○	●	-	-	-
Outlander (2007 - 2013)	○	●	○	●	-	-	-
Outlander (2013 >)	○	●	○	●	-	-	-
 Outlander PHEV (2015 >)	○	●	○	●	-	-	-
Shogun (2007 >)	○	●	○	●	-	-	-

Nissan







Juke (2010 >)	●	●	○	●	-	-	-
 Leaf (2011 >)	○	●	○	●	-	-	-
Micra (2011 - 2016)	●	●	○	●	-	-	-
 Micra (2017 >)	●	●	○	●	-	-	-
Murano (2016 >)	●	●	○	●	-	-	-
Note (2006 - 2013)	●	●	○	●	-	-	-
Note (2014 >)	●	●	○	●	-	-	-
Qashqai+2 (2008 - 2015)	○	●	○	●	○	-	○
Qashqai (2007 - 2013)	○	●	○	●	-	-	-
Qashqai (2014 >)	●	●	○	●	-	-	-
Quest MPV (2012 >)	○	●	-	●	●	-	●
Pulsar (2015 >)	●	●	○	●	-	-	-
X-Trail (2007 - 2015)	○	●	○	●	-	-	-
X-Trail (2015 >)	●	●	○	●	○	-	○



Opel



Adam (2013 >)	○	●	-	●	-	-	-
Agila (2008 >)	○	●	○	●	-	-	-

	1	2	3	4	5	6	7
 Ampera (2011 >)	●	●	-	●	-	-	-
Antara (2007 - 2015)	●	●	○	●	-	-	-
Astra (1998 - 2003)	○	●	○	●	-	-	-
Astra (2004 - 2010)	○	●	○	●	-	-	-
Astra 5dr (2010 >)	●	●	○	●	-	-	-
Astra Estate (2010 >)	●	●	○	●	-	-	-
Astra GTC (2011 >)	●	●	○	●	-	-	-
 Astra (2015 >)	●	●	○	●	-	-	-
Corsa D (2007 >)	○	●	○	●	-	-	-
Corsa 3dr Hatchback (2006 - 2015)	○	●	○	●	-	-	-
Corsa 5dr Hatchback (2006 - 2015)	○	●	○	●	-	-	-
Corsa 5dr(2015 >)	●	●	○	●	-	-	-
Corsa VXR (2007 >)	○	●	○	●	-	-	-
 Crossland X (2018 >)	●	●	○	●	-	-	-
 Grandland X (2018 >)	●	●	○	●	-	-	-
Insignia Hatchback (2009 >)	○	●	○	●	-	-	-
Insignia Saloon (2009 >)	○	●	○	●	-	-	-
Insignia Sports Tourer (2009 >)	○	●	○	●	-	-	-
 Insignia (2018 >)	○	●	○	●	-	-	-
Karl (2015 >)	●	●	○	●	-	-	-
Meriva (2010 >)	●	●	○	●	-	-	-
Mokka (2013 >)	●	●	○	●	-	-	-
Vectra (2005 - 2008)	○	●	○	●	-	-	-
Zafira (2005 - 2014)	○	●	○	●	○	-	○
Zafira Tourer (2014 >)	●	●	○	●	●	-	●

	1	2	3	4	5	6	7
Peugeot							
107 (2005 - 2014)	●	●	-	●	-	-	-
108 (2015 >)	●	●	-	●	-	-	-
206 3dr (2004 - 2009)	●	●	○	●	-	-	-
207 3dr (2006 - 2012)	●	●	○	●	-	-	-
207 5dr (2006 - 2012)	●	●	○	●	-	-	-
207 SW (2007 - 2012)	●	●	○	●	-	-	-
2008 (2013 >)	●	●	○	●	-	-	-
2008 (2020 >)	●	●	○	●	-	-	-
208 3dr (2013 >)	●	●	○	●	-	-	-
208 5dr (2013 >)	●	●	○	●	-	-	-
208 5dr (2020 >)	●	●	○	●	-	-	-
208 EV 5dr (2020 >)	●	●	○	●	-	-	-
307 (2001 - 2007)	●	●	○	●	-	-	-
307 Estate (2002 - 2007)	●	●	○	●	-	-	-
308 Hatchback (2007 - 2014)	●	●	○	●	-	-	-
308 SW (2008 - 2015)	●	●	○	●	-	-	-
308 SW (2015 >)	●	●	○	●	-	-	-
308 (2014 >)	●	●	○	●	-	-	-
SB! 3008 (2009 - 2016)	●	●	○	●	-	-	-
 3008 (2017 >)	●	●	○	●	-	-	-
407 (2004 - 2011)	●	●	○	●	-	-	-
407 SW (2004 - 2011)	●	●	○	●	-	-	-
4007 (2007 - 2012)	○	●	○	●	-	-	-
508 (2011 >)	●	●	○	●	-	-	-
508 SW/RXH (2011 >)	●	●	○	●	-	-	-







	1	2	3	4	5	6	7
 508 (2019 >)	●	●	○	●	-	-	-
SB! 5008 (2011 - 2018)	●	●	○	●	●	-	●
 SB! 5008 (2018 >)	●	●	○	●	●	-	●
Bipper (2008 >)	○	●	○	●	-	-	-
Expert Teepee (2007 - 2016)	○	●	○	●	●	●	●
Partner Combi (2004 - 2010)	●	●	○	●	-	-	-
Partner Teepee (2008 >)	●	●	○	●	-	-	-
RCZ (2011 >)	●	○	-	○	-	-	-
Traveller (2016 >)	●	●	●	●	●	●	●
Polestar							
 Polestar 2 (2020 >)	●	●	○	●	-	-	-
Porsche							
Cayenne (2011 - 2017)	●	●	○	●	-	-	-
 Cayenne E-Hybrid (2015 >)	●	●	○	●	-	-	-
 Cayenne (2017>)	●	●	○	●	-	-	-
Panamera (2011 >)	●	●	-	●	-	-	-
 Panamera E-Hybrid (2015 >)	●	●	-	●	-	-	-
Renault							
Captur (2015 >)	●	●	○	●	-	-	-
Clio (2005 - 2012)	●	●	○	●	-	-	-
Clio Renault Sport (2006 - 2012)	●	●	○	●	-	-	-
Clio Sport Tourer (2007 - 2012)	●	●	○	●	-	-	-
Clio (2013 >)	●	●	○	●	-	-	-

	1	2	3	4	5	6	7
Espace (2003 - 2012)	●	●	●	●	○	-	○
Grand Espace (2003 - 2012)	●	●	●	●	○	-	○
Kadjar (2015 >)	●	●	○	●	-	-	-
 Koleos (2018 >)	●	●	○	●	-	-	-
Laguna (2008 - 2012)	●	●	○	●	-	-	-
Laguna Sport Tourer (2008 - 2012)	●	●	○	●	-	-	-
Megane (2007)	●	●	○	●	-	-	-
Megane Hatchback (2002 - 2009)	●	●	○	●	-	-	-
SB! Megane Hatchback (2008-16)	●	●	○	●	-	-	-
Megane Sport Tourer (2009 - 2016)	●	●	○	●	-	-	-
 Megane (2016 >)	●	●	○	●	-	-	-
Modus (2004 - 2012)	●	●	○	●	-	-	-
Grand Modus (2008 - 2012)	●	●	○	●	-	-	-
SB! Scenic (2003 - 2009)	●	●	○	●	-	-	-
SB! Scenic (2009 - 2016)	●	●	○	●	●	-	●
 Scenic (2017 >)	●	●	○	●	-	-	-
Twingo (2007 - 2014)	●	●	-	●	-	-	-
Twingo (2015 >)	●	●	-	●	-	-	-
Saab							
9-3 (2002 - 2012)	○	●	○	●	-	-	-
9-3 Sport Wagon (2005 - 2012)	○	●	○	●	-	-	-
9-3 X (2009 - 2012)	○	●	○	●	-	-	-
9-5 Estate (2005 - 2010)	○	●	○	●	-	-	-
9-5 (2011-2012)	●	●	○	●	-	-	-

	1	2	3	4	5	6	7
Seat							
SB! Alhambra (2010 >)	●	●	●	●	○	-	○
Altea (2004 - 2011)	●	●	○	●	-	-	-
Altea XL (2007 - 2011)	●	●	○	●	-	-	-
Altea Freetrack4 (2007 - 2009)	●	●	○	●	-	-	-
Arosa (1997 - 2004)	○	○	-	○	-	-	-
 Arona (2018 >)	●	●	○	●	-	-	-
 Ateca (2018 >)	●	●	○	●	-	-	-
Exeo (2008 - 2014)	●	●	○	●	-	-	-
Exeo ST Estate (2008 - 2014)	●	●	○	●	-	-	-
Ibiza Cupra (2009 >)	●	●	○	●	-	-	-
Ibiza (2009 - 2017)	●	●	○	●	-	-	-
 Ibiza (2018 >)	●	●	○	●	-	-	-
Leon Cupra (2007 - 2011)	●	●	○	●	-	-	-
Leon (1998 - 2004)	○	●	○	●	-	-	-
Leon (2005 - 2012)	●	●	○	●	-	-	-
Leon (2013 >)	●	●	○	●	-	-	-
Mii (2011 >)	●	●	○	●	-	-	-
Toledo (2013 >)	●	●	○	●	-	-	-

Skoda

Citigo (2012 >)	●	●	○	●	-	-	-
Fabia (2007 - 2014)	●	●	○	●	-	-	-
Fabia Combi (2008 - 2014)	●	●	○	●	-	-	-
Fabia (2015 - 2020)	●	●	○	●	-	-	-
 Fabia (2021 >)	●	●	○	●	-	-	-

	1	2	3	4	5	6	7
 Kamiq (2020 >)	●	●	○	●	-	-	-
 Karoq (2018 >)	●	●	○	●	-	-	-
Kodiaq (2017 >)	●	●	○	●	○	-	○
Octavia (2004 - 2013)	●	●	○	●	-	-	-
Octavia (2013 - 2020)	●	●	○	●	-	-	-
 Octavia (2020 >)	●	●	○	●	-	-	-
Rapid (2013 >)	●	●	○	●	-	-	-
Roomster (2006 >)	○	●	○	●	-	-	-
 Scala (2020 >)	●	●	○	●	-	-	-
Superb Combi Estate (2008 >)	●	●	○	●	-	-	-
Superb (2008 - 2014 >)	●	●	○	●	-	-	-
 Superb (2015 >)	●	●	○	●	-	-	-
Yeti (2009 - 2017)	●	●	○	●	-	-	-
 ⚡ Enyaq EV (2021>)	●	●	○	●	-	-	-
Smart							
For Two Coupe (2007 >)	○	-	-	-	-	-	-
FourFour (2015 >)	○	●	-	●	-	-	-
Ssangyong							
Actyon (2006 - 2011)	○	●	○	●	-	-	-
Korando (2011 >)	○	●	○	●	-	-	-
Musso Pickup (2016 >)	○	●	○	●	-	-	-
Rexton (2014 >)	○	●	○	●	-	-	-
Tivoli (2016 >)	○	●	○	●	-	-	-
Turismo (2014 >)	○	●	○	●	●	○	●

1 2 3 4 5 6 7

Suzuki





 Across (2020 >)	●	●	○	●	-	-	-
Alto (2009 >)	○	●	-	●	-	-	-
 Baleno (2016 >)	●	●	○	●	-	-	-
Grand Vitara (2006 >)	○	●	○	●	-	-	-
Vitara (2015 >)	○	●	○	●	-	-	-
Splash (2008 >)	○	●	○	●	-	-	-
Swift Sport (2011 - 2017)	○	●	○	●	-	-	-
SX - 4 (2006 >)	○	●	○	●	-	-	-
 Ignis (2016 >)	○	●	○	●	-	-	-
 Swift (2017 >)	○	●	○	●	-	-	-



Subaru

BRZ (2012 >)	○	○	-	○	-	-	-
Forester (2013 >)	○	●	○	●	-	-	-
Impreza 5dr (2007 - 2012)	○	●	○	●	-	-	-
Impreza 5 Door (2013 >)	○	●	○	●	-	-	-
Legacy (2012 >)	○	●	○	●	-	-	-
Outback (2012 >)	○	●	○	●	-	-	-
XV Hatchback (2011 >)	○	●	○	●	-	-	-



Tesla

 Model S (2014 >)	●	●	○	●	-	-	-
 Model X (2016 >)	●	●	○	●	○	-	○
  Model 3 (2019 >)	●	●	○	●	-	-	-

	1	2	3	4	5	6	7
Toyota							
Auris (2007 - 2012)	○	●	○	●	-	-	-
Auris (2013 >)	●	●	○	●	-	-	-
Avensis Hatchback (2003 - 2011)	○	●	○	●	-	-	-
Avensis Tourer (2009 >)	●	●	○	●	-	-	-
Aygo (2005 - 2014)	○	●	-	●	-	-	-
Aygo (2014 - 2019)	○	●	-	●	-	-	-
 Aygo (2019 >)	●	●	-	●	-	-	-
 Aygo X (2021 >)	●	●	-	●	-	-	-
 Corolla (2018 >)	●	●	○	●	-	-	-
C-HR (2017 >)	●	●	○	●	-	-	-
EZ MPV (2013 >)	○	●	○	●	-	-	-
GT86 (2012 >)	○	○	-	○	-	-	-
Highlander (2013 >)	○	●	○	●	-	-	-
 ⚡ Highlander (2021 >)	●	●	○	●	-	-	-
Land Cruiser (2003 - 2009)	○	●	○	●	-	-	-
Land Cruiser (2009 >)	○	●	○	●	-	-	-
⚡ Prius (2004 - 2010)	○	●	○	●	-	-	-
⚡ Prius (2010 >)	○	●	○	●	-	-	-
⚡ Prius PHEV (2015 >)	●	●	○	●	-	-	-
⚡ Prius Plus + (2012 >)	●	●	○	●	-	-	-
Prius 4 (2016 >)	●	●	○	●	-	-	-
Rav 4 MK3 (2006 - 2011)	○	●	○	●	-	-	-
RAV4 (2013 - 2019)	●	●	○	●	-	-	-
⚡ RAV4 Hybrid (2014 - 2019)	●	●	○	●	-	-	-
 ⚡ RAV4 (2019 >)	●	●	○	●	-	-	-



	1	2	3	4	5	6	7
SBI Verso (2009 - 2012)	○	●	○	●	-	-	-
SBI Verso (2013 >)	●	●	○	●	-	-	-
Yaris (2008 - 2011)	○	●	○	●	-	-	-
Yaris (2011 - 2017)	○	●	○	●	-	-	-
 Yaris (2019 >)	●	●	○	●	-	-	-
 Yaris Cross (2021 >)	●	●	○	●	-	-	-











Vauxhall







Adam (2013 >)	●	●	-	●	-	-	-
Agila (2008 >)	●	●	○	●	-	-	-
Ampera (2011)	●	●	-	●	-	-	-
Antara (2007 - 2015)	●	●	○	●	-	-	-
Astra (1998 - 2003)	○	●	○	●	-	-	-
Astra (2004 - 2010)	○	●	○	●	-	-	-
Astra 5dr (2010 >)	●	●	○	●	-	-	-
Astra Estate (2010 >)	●	●	○	●	-	-	-
Astra GTC (2011 >)	●	●	○	●	-	-	-
 Astra (2015 >)	●	●	○	●	-	-	-
Corsa D (2007 >)	○	●	○	●	-	-	-
Corsa 3dr Hatchback (2006 - 2015)	○	●	○	●	-	-	-
Corsa 5dr Hatchback (2006 - 2015)	○	●	○	●	-	-	-
Corsa 5dr (2015 >)	●	●	○	●	-	-	-
Corsa VXR (2007 >)	○	●	○	●	-	-	-
 Crossland X (2018 >)	●	●	○	●	-	-	-
 Grandland X (2018 >)	●	●	○	●	-	-	-
Insignia Hatchback (2009 >)	○	●	○	●	-	-	-

	1	2	3	4	5	6	7
Insignia Saloon (2009 >)	○	●	○	●	-	-	-
Insignia Sports Tourer (2009 >)	○	●	○	●	-	-	-
 Insignia (2018 >)	○	●	○	●	-	-	-
Meriva (2010 >)	●	●	○	●	-	-	-
Mokka (2013 >)	●	●	○	●	-	-	-
Vectra (2005 - 2008)	○	●	○	●	-	-	-
Viva (2015 >)	●	●	○	●	-	-	-
Zafira (2005 - 2014)	○	●	○	●	○	-	○
Zafira Tourer (2012 >)	●	●	○	●	○	-	○

Volkswagen

 Arteon (2017 >)	●	●	○	●	-	-	-
Beetle (1999 - 2005)	○	○	○	○	-	-	-
Beetle (2012 >)	●	●	-	●	-	-	-
Caddy (2010 >)	●	●	○	●	○	○	○
Caddy Maxilife (2010 - 2015)	●	●	○	●	○	○	○
Multivan Caravelle (2008 >)	●	●	-	●	●	○	●
Golf Mk5 (2004 - 2009)	○	●	○	●	-	-	-
Golf Cabriolet (2009 - 2014)	○	○	○	○	-	-	-
Golf Plus (2009 - 2012)	●	●	○	●	-	-	-
Golf Mk6 (2008 - 2012)	●	●	○	●	-	-	-
Golf Mk7 (2012 >)	○	●	○	●	-	-	-
 ID3 EV (2020 >)	●	●	○	●	-	-	-
 ID4 EV (2021 >)	●	●	○	●	-	-	-
Jetta (2011 >)	○	●	○	●	-	-	-
Lupo (1999 - 2005)	○	○	-	○	-	-	-

	1	2	3	4	5	6	7
Passat (2005 - 2010)	○	●	○	●	-	-	-
Passat (2010 - 2015)	●	●	○	●	-	-	-
 Passat Saloon (2015 >)	●	●	○	●	-	-	-
Passat Alltrack (2012 >)	●	●	○	●	-	-	-
Passat CC (2008 >)	●	●	○	●	-	-	-
Passat Estate (2005 -2011)	○	●	○	●	-	-	-
 Passat Estate (2015 >)	●	●	○	●	-	-	-
Polo (2009 - 2017)	○	●	○	●	-	-	-
 Polo (2017 >)	●	●	○	●	-	-	-
Scirocco (2011)	●	●	-	●	-	-	-
SB! Sharan (2010 >)	●	●	●	●	○	-	○
Tiguan (2008 - 2016)	●	●	○	●	-	-	-
 Tiguan (2016 >)	●	●	○	●	-	-	-
 Tiguan Allspace (2017 >)	○	●	○	●	○	-	○
Touareg (2003 - 2009)	●	●	○	●	-	-	-
Touareg (2010 - 2018)	●	●	○	●	-	-	-
 Touareg (2018 >)	●	●	○	●	-	-	-
 T-Cross (2019 >)	●	●	○	●	-	-	-
 T-Roc (2017 >)	●	●	○	●	-	-	-
SB! Touran (2010 - 2015)	●	●	○	●	○	-	○
 Touran (2016 >)	●	●	●	●	●	-	●
UP! (2012 >)	○	●	○	●	-	-	-
 E - UP! (2014 >)	○	●	○	●	-	-	-
Volvo							
C30 (2007 - 2013)	●	●	-	●	-	-	-

	1	2	3	4	5	6	7
S40 (2004 - 2012)	●	●	○	●	-	-	-
S60 (2010 >)	●	●	○	●	-	-	-
S80 (2007 >)	●	●	○	●	-	-	-
 S90 (2016 >)	●	●	○	●	-	-	-
V40 (2012 >)	●	●	○	●	-	-	-
V40 Cross Country (2013 >)	●	●	○	●	-	-	-
V50 (2004 - 2012)	●	●	○	●	-	-	-
V60 (2011 - 2017)	●	●	○	●	-	-	-
⚡ V60 PHEV (2015 - 2018)	●	●	○	●	-	-	-
 V60 (2018 >)	●	●	○	●	-	-	-
V70 (2008 >)	●	●	○	●	-	-	-
 V90 (2016 >)	●	●	○	●	-	-	-
 XC40 (2018 >)	●	●	○	●	-	-	-
XC60 (2008 - 2017)	●	●	○	●	-	-	-
 XC60 (2017 >)	●	●	○	●	-	-	-
XC70 (2008 >)	●	●	○	●	-	-	-
XC90 (2003 - 2014)	●	●	○	●	○	-	○
 XC90 (2016 >)	●	●	○	●	●	-	●

Right by your Side

Landline: Go freephone fabulous on 0800 014 9252*
Mobile: Ring 0333 323 1729 International: +44 120 486 1007

*calls from BT landlines are free but calls from mobiles
and other networks may vary.

Email: cuddle@cosatto.com

Letter: Cosatto Limited, Bentinck Mill, Bentinck Street,
Farnworth, Bolton, Lancs, BL4 7EP, England.

All the design and trademarks contained herein are the property
of Cosatto Limited. No part of this document may be reproduced
without the permission of Cosatto Limited.

www.cosatto.com

(EN) Notice:

(100 - 150cm) This is an i-Size booster seat Enhanced Child Restraint System. It is approved according to UN Regulation No.129, for use primarily in "i-Size seating positions" as indicated by vehicle manufacturers in the vehicle user's manual.

For compatibility of non i-Size vehicle, please refer to the fit checker app (<http://cosat.to/fitchecker>) or the compatibility list on the website (<http://cosat.to/ninja2isizev1>).

Never use this child restraint system in seating positions where an active frontal airbag is installed.

Important - Do not use forward facing before the child's age exceeds 15 months (refer to instructions).

If in doubt, consult either the child restraint manufacturer or retailer.