



AMERICAN SPECIALTIES, INC.
 441 Saw Mill River Road, Yonkers, NY 10701
 (914) 476.9000 • (914) 476.0688
 www.americanspecialties.com

MODEL №: 0031

ISSUED: 01-87

REVISED: 11 JUL 2019

SEMI-RECESSED TWIN HIDE-A-ROLL TOILET PAPER DISPENSER

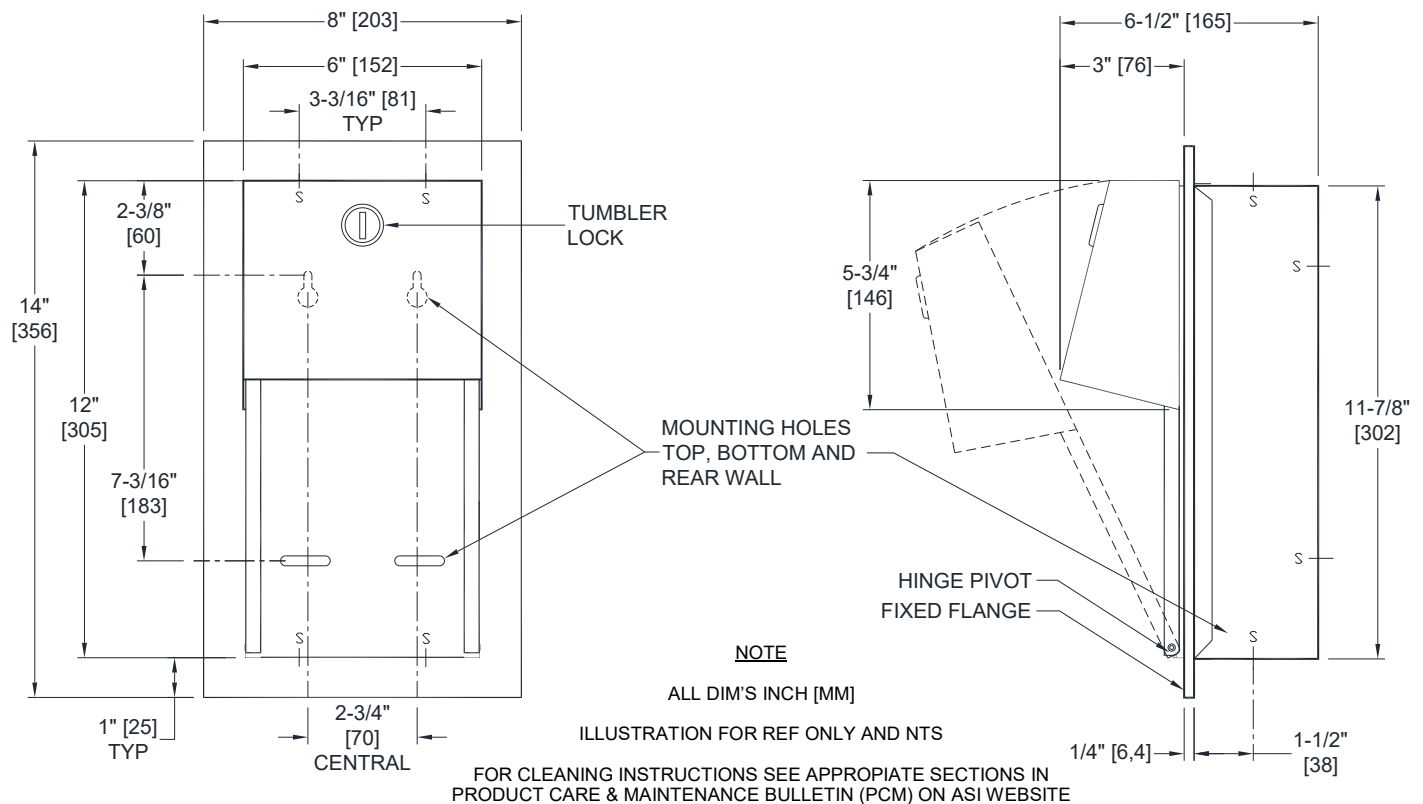

SPECIFICATION

Semi-Recessed Mounted Twin Hide-A-Roll Toilet Paper Dispenser shall hold and dispense two (2) standard or two (2) 5-1/4" Dia [Ø133] 1800 sheet tissue rolls and have door, door frame, and dispensing mechanism guide tracks of 18 gage [1,3] type 304 stainless steel alloy 18-8. Cabinet body shall be 22 gage [0,8] same grade. All exposed surfaces shall be satin finish and be protected during shipment with PVC film easily removable after installation. Internal mechanism levers shall be molded high-impact resistant plastic for smooth operation. Structural assembly of body and door components shall be of welded construction. Door hinge shall be heavy-duty stainless steel 3/16" Dia [Ø4,8] rivets. Door shall be held closed with a tumbler lock keyed alike to other ASI washroom equipment. Cabinet shall include two (2) theft and vandal resistant rollers (p/n R-004) that are molded high-impact resistant plastic with integral molded-in plated steel endpins.

Semi-Recessed Mounted Twin Hide-a-Roll Toilet Paper Dispenser shall be Model № 0031 as manufactured by American Specialties, Inc. 441 Saw Mill River Road Yonkers, New York 10701-4913.

INSTALLATION

Unit is recessed mounted in wall using four (4) № 10 self-threading screws (by others). Top two (2) mounting holes through back are "keyhole" slots for ease in hanging unit on pre-installed screws. Bottom two (2) mounting holes are horizontal slots for ease of adjustment. Alternate mounting holes are provided in top and bottom of unit for installation convenience. For compliance with 2010 ADA Accessibility Standards and 2015 ABA Standards install unit so that center line of dispenser is 7" [178] min to 9" [229] max in front of the toilet closet and axis of roll is 15" [381] min AFF (Above Finished Floor) to 48" [1219] max AFF.

Rough Wall Opening (RWO) required is 6-1/4" [159] W x 12-1/4" [311] H x 3-3/8" [86] D

OPERATION

Reloading instructions are printed on graphic label inside door. Bottom roll is depleted prior to top roll automatically ropping into lower position for use. Empty rollers cannot be removed without key unlocking door.