

**abax2**

ABAX 2 wireless system controller

**ACU-220**

Firmware version 6.07

**EN**

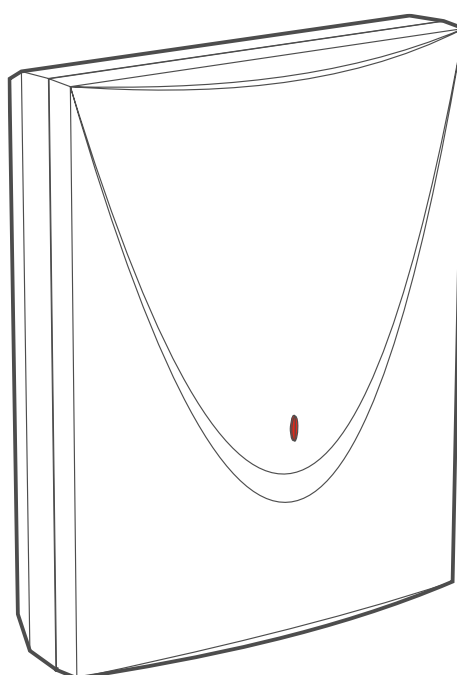

**CE**

acu-220\_en 04/23

**Satel**®

SATEL sp. z o.o. • ul. Budowlanych 66 • 80-298 Gdańsk • POLAND  
tel. +48 58 320 94 00  
[www.satel.pl](http://www.satel.pl)

## IMPORTANT

The device should be installed by qualified personnel.

Prior to installation, please read carefully this manual in order to avoid mistakes that can lead to malfunction or even damage to the equipment.

Disconnect power before making any electrical connections.

Changes, modifications or repairs not authorized by the manufacturer shall void your rights under the warranty.

The rating plate of the device is located on the enclosure base.



The device meets the requirements of the applicable EU directives.



The device is designed for indoor installation.



The device must not be disposed of with other municipal waste. It should be disposed of in accordance with the existing rules for environment protection (the device was placed on the market after 13 August 2005).



The device meets the technical regulations of the Eurasian Customs Union.

SATEL aims to continually improve the quality of its products, which may result in changes in their technical specifications and software. Current information about the changes being introduced is available on our website.

Please visit us at:  
<https://support.satel.pl>

**Hereby, SATEL sp. z o.o. declares that the radio equipment type ACU-220 is in compliance with Directive 2014/53/EU. The full text of the EU declaration of conformity is available at the following internet address: [www.satel.pl/ce](http://www.satel.pl/ce)**

**In the EU, this radio equipment is only permitted to operate in the 868 MHz frequency band.**

The following symbols may be used in this manual:



- note,



- caution.

## Changes made to the firmware version 6.07

### RS-485 bus

New groups in the table of Modbus RTU protocol registers.

## CONTENTS

1	Introduction .....	5
2	Features.....	5
3	Electronics board .....	6
3.1	Terminals.....	7
3.2	DIP-switches.....	7
3.2.1	Selecting the controller operating mode.....	8
3.2.2	Selecting the transmitting antenna.....	8
3.2.3	Address setting [controller in the INTEGRA system] .....	8
3.2.4	Enabling / disabling the support of the unregistered ARF-200 tester .....	9
3.3	Outputs indicating problems in the ABAX 2 system.....	9
3.4	Control inputs [universal module of wireless devices].....	10
3.5	Programmable outputs [universal module of wireless devices] .....	10
3.6	RS-485 bus [universal module of wireless devices].....	11
3.6.1	Table of Modbus RTU protocol registers .....	11
4	Installation of the controller .....	14
4.1	Selecting a mounting location .....	14
4.2	Preparing the cabling.....	15
4.3	Installation of enclosure .....	15
4.4	Setting DIP switches.....	16
4.5	Connecting the wires .....	16
4.5.1	Expander of wireless devices for SATEL alarm control panels.....	16
4.5.2	Universal module of wireless devices .....	17
4.5.2.1	Connecting inputs and outputs of the controller.....	17
4.5.2.2	Connecting the RS-485 bus.....	18
4.6	Powering on and starting the controller .....	18
5	ABAX 2 Soft program.....	18
5.1	Description of the program .....	19
5.1.1	Menu bar in the program.....	19
5.1.2	Additional menu .....	19
5.2	Establishing connection between the program and the controller.....	20
5.3	Configuration .....	20
5.4	Devices.....	22
5.5	Status .....	24
5.5.1	Graphs.....	26
5.5.2	Comm. history.....	26
5.6	Keyfobs.....	28
5.6.1	Keyfob state .....	28
6	Wireless devices supported by the controller.....	29
6.1	Devices.....	29
6.2	Keypads.....	30
6.3	Keyfob .....	30
7	Installation of ABAX 2 wireless devices .....	30
7.1	Registering devices to the controller.....	31
7.1.1	Expander for the INTEGRA series control panels.....	31
7.1.1.1	Adding new wireless devices.....	33
7.1.1.2	Removing wireless devices .....	35

7.1.2	Expander for the PERFECTA 64 M control panel.....	36
7.1.2.1	Adding new wireless devices.....	37
7.1.2.2	Removing wireless devices .....	39
7.1.3	Expander for VERSA series control panels .....	39
7.1.3.1	Adding new wireless devices.....	39
7.1.3.2	Removing wireless devices .....	41
7.1.4	Universal module of wireless devices .....	41
7.1.4.1	Adding new wireless devices.....	42
7.1.4.2	Removing wireless devices .....	42
8	Programming the ABAX 2 system .....	43
8.1	Expander for the INTEGRA / VERSA series control panels .....	43
8.1.1	Controller settings.....	43
8.1.2	Functions .....	45
8.1.3	Device settings .....	45
8.1.3.1	Programming devices using the DLOADX program .....	47
8.1.3.2	Programming devices using the LCD keypad.....	51
8.1.4	Specific character of the operation of wireless devices .....	55
8.1.4.1	Wireless detectors .....	55
8.1.4.2	Wireless sirens .....	55
8.1.4.3	Wireless expanders of hardwired zones and outputs .....	56
8.1.4.4	Smart plug / Wireless 230 VAC controller .....	56
8.1.4.5	Wireless radiator thermostat.....	56
8.1.4.6	Radio signal repeater .....	57
8.2	Expander for the PERFECTA 64 M control panel.....	57
8.2.1	Controller settings.....	57
8.2.1.1	Wireless devices.....	58
8.2.2	Programming devices in the PERFECTA Soft program.....	59
8.2.3	Specific character of the wireless devices operation .....	62
8.2.3.1	Wireless detectors .....	63
8.2.3.2	Wireless sirens .....	63
8.2.3.3	Wireless expanders of hardwired zones and outputs .....	64
8.2.3.4	Smart plug / 230 VAC wireless controller .....	64
8.2.3.5	Wireless radiator thermostat.....	65
8.2.3.6	Radio signal repeater .....	65
8.3	Universal module of wireless devices.....	65
8.3.1	Programming devices using the ABAX 2 Soft program .....	65
8.3.2	Specific character of the operation of wireless devices .....	68
8.3.2.1	Wireless detectors .....	69
8.3.2.2	Wireless sirens .....	69
8.3.2.3	Wireless expanders of hardwired zones and outputs .....	69
8.3.2.4	Smart plug / Wireless 230 VAC controller .....	70
8.3.2.5	Wireless radiator thermostat.....	70
8.3.2.6	Radio signal repeater .....	70
8.3.2.7	Panic button .....	70
9	APT-200 keyfobs .....	71
9.1	Expander of wireless devices for SATEL alarm control panels .....	71
9.1.1	Keyfobs in the INTEGRA system.....	71
9.1.1.1	Keyfob management using the DLOADX program .....	72
9.1.2	Keyfobs in the PERFECTA 64 M system.....	73
9.1.2.1	Keyfob management using the PERFECTA Soft program .....	73
9.1.3	Keyfobs in the VERSA system .....	75

---

- 9.1.3.1 Keyfob management using the DLOADX program .....75
- 9.2 Universal module of wireless devices .....77
  - 9.2.1 Keyfob management.....77
    - 9.2.1.1 Adding a keyfob.....77
    - 9.2.1.2 Assigning an output to keyfob button (combination of buttons) .....77
    - 9.2.1.3 Assigning zones to LEDs.....77
    - 9.2.1.4 Removing a keyfob .....78
- 10 Controller firmware update.....78
  - 10.1 Updating the firmware of ABAX 2 wireless devices .....78
- 11 Restoring the controller factory settings.....78
- 12 Battery replacement in ABAX 2 device .....79
- 13 Specifications.....79
- 14 Manual update history.....80

## 1 Introduction

---

The ACU-220 controller enables expansion of the alarm system or automation system by adding the ABAX 2 wireless devices. It can work as:

- expander of wireless devices for:
  - INTEGRA series control panels (firmware version 1.21 or newer),
  - PERFECTA 64 M control panel,
  - VERSA series control panels (firmware version 1.09 or newer),
- universal module of wireless devices.



*The controller does not support the ABAX wireless devices.*

The ABAX 2 system offers two-way communication. All transmissions are acknowledged, which ensures that the information has been received and makes it possible to check the presence of devices in the system in real time. Configuration of settings, testing and updating of the firmware of wireless devices are carried out via radio and, consequently, do not require removal of their enclosure.

## 2 Features

---

- Support for up to 48 ABAX 2 wireless devices (the number of supported devices depends on the configuration).
- Support for ABAX 2 wireless keypads: [expander of wireless devices for SATEL alarm control panels]
  - up to 4 INT-KWRL2 keypads,
  - up to 4 PRF-LCD-A2 keypads,
  - up to 6 VERSA-KWRL2 keypads.
- Support for APT-200 keyfobs:
  - expander of wireless devices for SATEL alarm control panels – the number of supported keyfobs depends on the maximum number of control panel users,
  - universal module of wireless devices – up to 256 keyfobs.
- AES standard encrypted two-way radio communication in the 866 MHz / 868 MHz / 915 MHz frequency band.
- Transmission channel diversity – 4 channels for automatic selection of the one that will enable transmission without interference with other signals in the 866 MHz / 868 MHz / 915 MHz frequency band.
- Antenna diversification – automatic selection of the antenna that will be used for receiving transmission, depending on the level of received radio signal.
- 4 OC type outputs indicating problems in the ABAX 2 system:
  - device tamper,
  - no communication with the wireless device,
  - jamming radio communication,
  - wireless device power trouble.
- 4 inputs to control operation of wireless devices. [universal module of wireless devices]
- 8 OC type outputs: [universal module of wireless devices]
  - indication of the status of wireless devices (e.g. alarm from detector, siren signal triggered, etc.),
  - ability to control with keyfobs and panic buttons.

- Ability to work with any alarm system or automation system thanks to the inputs and outputs. [universal module of wireless devices]
- Communication bus for connecting the controller to a SATEL control panel. [expander of wireless devices for SATEL alarm control panels]
- RS-485 communication bus for integrating the controller, e.g. with automation or data acquisition systems. [universal module of wireless devices]
- Controller firmware update capability.
- Ability to remotely update the firmware of wireless devices (except for the ASD-250 wireless smoke detector).
- Tamper protection against enclosure opening.
- Tamper input.

### 3 Electronics board

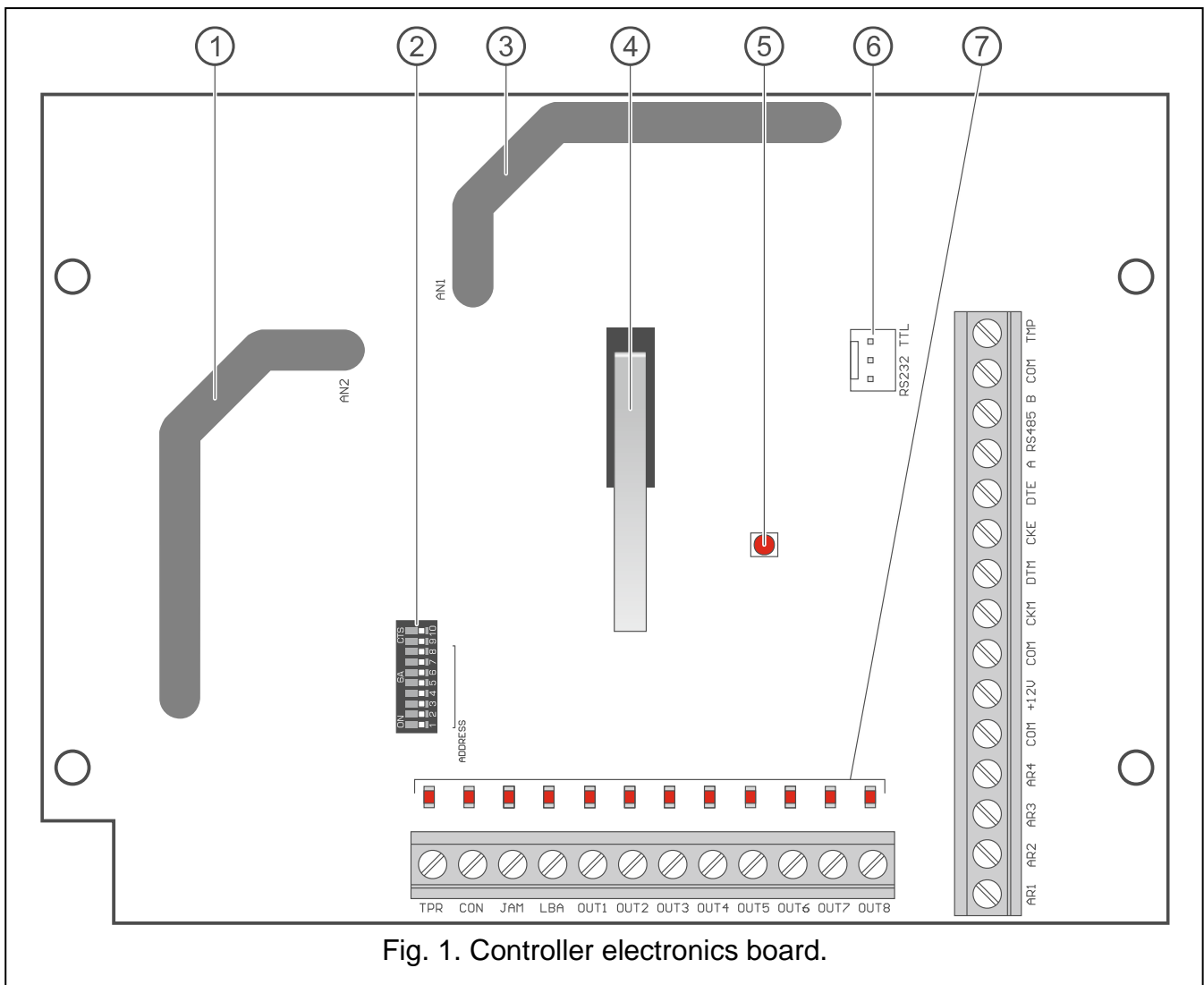

Fig. 1. Controller electronics board.

- ① antenna 2 (printed on the electronics board and designated as AN2).
- ② DIP-switches.
- ③ antenna 1 (printed on the electronics board and designated as AN1).
- ④ tamper switch.



- ⑤ LED indicating the status of communication with the control panel:  
ON – no communication with the control panel,  
flashing – communication with the control panel OK.
- ⑥ RS-232 port (TTL standard).
- ⑦ LEDs indicating the output state:  
OFF – open,  
ON – shorted to common ground.

### 3.1 Terminals

---

<b>TPR</b>	- OC type output indicating tamper of the controller or any wireless device.
<b>CON</b>	- OC type output indicating loss of communication with wireless devices.
<b>JAM</b>	- OC type output indicating jamming of radio communication.
<b>LBA</b>	- OC type output indicating power troubles of wireless devices: <ul style="list-style-type: none"> <li>– low battery in a battery-operated device,</li> <li>– AC mains loss (ACX-220 expander supplied from a power supply connected to the APS connector / ARU-200 radio signal repeater),</li> <li>– low battery or missing battery (ACX-220 expander supplied from a power supply connected to the APS connector / ARU-200 radio signal repeater),</li> <li>– overload of the power supply connected to the APS connector of ACX-220 expander.</li> </ul>
<b>OUT1...OUT8</b>	- OC type output indicating the status of wireless devices or controlled with keyfobs and panic buttons.
<b>AR1...AR4</b>	- input for controlling operation of wireless devices.
<b>COM</b>	- common ground.
<b>+12V</b>	- power input.
<b>CKM</b>	- keypad bus clock.
<b>DTM</b>	- keypad bus data.
<b>CKE</b>	- expander bus clock.
<b>DTE</b>	- expander bus data.
<b>A RS485 B</b>	- RS-485 bus.
<b>TMP</b>	- tamper input (NC). Connected in parallel with the tamper switch.



*If the controller is installed in the enclosure in which tamper switch is open, and the enclosure tamper switch is not to be connected to the tamper input, connect the TMP terminal to the COM terminal of the controller.*

### 3.2 DIP-switches

---

Using the DIP-switches, you can:

- define the controller operating mode,
- select the transmitting antenna,
- set the controller address (operating mode: expander of wireless devices for the INTEGRA series control panels),
- enable / disable the support of the ARF-200 radio signal level tester that has not been registered to the controller.

### 3.2.1 Selecting the controller operating mode

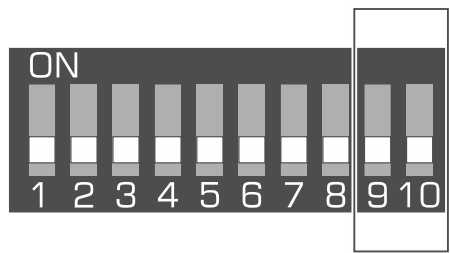

Fig. 2. Switches defining the controller operating mode.

**Switches 9 and 10** (Fig. 2) define the controller operating mode – see Table 1.

Controller operating mode	DIP-switch	
	9	10
Expander of wireless devices for the INTEGRA series control panels	OFF	OFF
Expander of wireless devices for the PERFECTA 64 M control panel	OFF	ON
Expander of wireless devices for the VERSA series control panels	OFF	ON
Universal module of wireless devices	ON	OFF
	ON	ON

Table 1.

### 3.2.2 Selecting the transmitting antenna

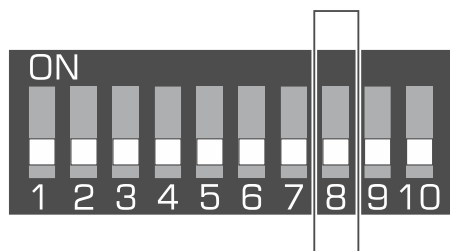

Fig. 3. Switch for selecting the antenna used for transmitting.

**Switch 8** (Fig. 3) defines the antenna that will be used for transmitting:

OFF position – antenna 1 (AN1),

ON position – antenna 2 (AN2).

Thus you can select the antenna whose polarization is consistent with that of the antennas in wireless devices installed in the system. This contributes to the quality of the radio signal.



*Test the antennas to make sure which of them ensures better communication with the wireless devices registered in the controller.*

### 3.2.3 Address setting [controller in the INTEGRA system]

**Switches 1-5** (Fig. 4) are used to set the address when the controller is connected to the INTEGRA series control panel (in the other operating modes, the settings of switches 1-5 are

irrelevant). Numerical value is assigned to each switch. In OFF position, the value is 0. Numerical values assigned to individual switches in ON position are presented in Table 2. The sum of numerical values assigned to switches 1-5 constitutes the address set in the device. The address must be different than that set in the other devices connected to the expander bus of the control panel.

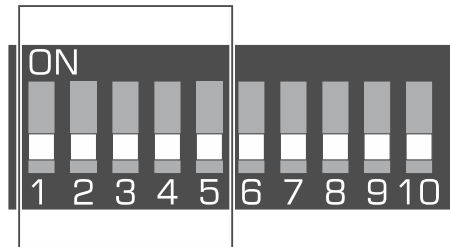

Fig. 4. Switches for setting the address of the controller in the INTEGRA system.

<b>DIP-switch</b>	1	2	3	4	5
<b>Number</b>	1	2	4	8	16

Table 2.

**i** If the controller is to be connected to the control panel to which an ABAX 2 / ABAX controller is already connected, it is recommended that the address to be set in the new controller be higher than that in the controller already connected to the control panel.

### 3.2.4 Enabling / disabling the support of the unregistered ARF-200 tester

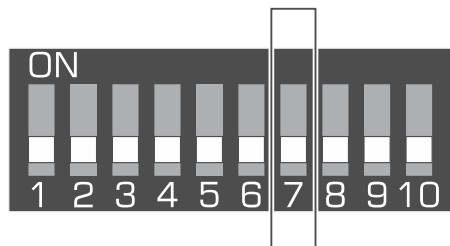

Fig. 5. Switch for enabling / disabling the support of the unregistered ARF-200 tester.

**Switch 7** (Fig. 5) is used to enable / disable the support of the ARF-200 tester that has not been registered to the controller:

OFF position – support disabled (the controller will support the ARF-200 tester only if it is registered to the system),

ON position – support enabled.

**i** Remember to disable the support of the unregistered ARF-200 tester after the testing is finished.

### 3.3 Outputs indicating problems in the ABAX 2 system

**i** If the controller is used as an expander of wireless devices for SATEL alarm control panels, information about problems is sent to the control panel via the communication bus. The outputs are for auxiliary purposes only.

The 4 OC type outputs – TPR, CON, JAM and LBA – provide information about problems in the ABAX 2 system. You can program these outputs as NO (normally open) or NC (normally closed).

The outputs can be connected to the control panel zones or they can be used to control the operation of signaling devices.

### **3.4 Control inputs [universal module of wireless devices]**

---

The 4 inputs (AR1...AR4) control the operation of wireless devices. Depending on the type of device, the input:

- wireless detectors – controls the operating mode:
  - input activated – active mode,
  - input in normal state – passive mode.
- wireless sirens – controls signaling:
  - input activated – signaling enabled,
  - input in normal state – signaling disabled.
- expanders of wired zones/outputs – controls expander outputs:
  - input activated – output turned on,
  - input in normal state – output turned off.
- wireless 230 VAC controllers – controls the relay (230 VAC power):
  - input activated – relay turned on (power on),
  - input in normal state – relay turned off (power off).
- wireless radiator thermostats – controls the operating mode:
  - input activated – “Comfortable temperature” mode,
  - input in normal state – “Economic temperature” mode.

For each wireless device registered to the controller, indicate the control input. For some devices (ASP-200 and ASP-215 sirens, ACX-210 and ACX-220 expanders, ASW-210 controller), which take up two or more positions on the list of devices, the control input must be indicated for each position. One input can control any number of devices.

You can program the control inputs as NO (normally open) or NC (normally closed).

To the control inputs, you can connect e.g. outputs of the control panel or another device.



*If the controller is integrated with another system using the RS-485 bus (see “RS-485 bus” p. 11), the control inputs are not supported.*

### **3.5 Programmable outputs [universal module of wireless devices]**

---

8 OC type outputs (OUT1...OUT8) can indicate the status of wireless devices, or can be controlled with keyfobs and panic buttons. Depending on the type of wireless device, the output is turned on when:

- alarm occurs (wireless detector),
- signaling is triggered (wireless siren),
- 230 VAC mains is lost (ARU-200 radio signal repeater),
- battery trouble occurs (ARU-200 radio signal repeater),
- expander input is activated (expander of wired zones/outputs),
- ASW-210 controller relay is turned on / input is activated,
- ASW-200 smart plug relay is turned on / button is pressed.

Each wireless device must be assigned to an output. If the device occupies two or more positions on the device list, each position must be assigned to an output. You can assign any number of devices to one output.

Each keyfob button and panic button can control one output.

You can program the outputs as NO (normally open) or NC (normally closed).

The outputs can be connected, for example, to the control panel zones, or they can be used to control operation of automation devices.

### 3.6 RS-485 bus [universal module of wireless devices]

The RS-485 bus can integrate the controller with other systems (e.g. automation or data acquisition systems) to inform the systems on the state of wireless devices and to receive from them control commands for the controller. The data is transmitted using the Modbus RTU communications protocol. The controller is a “Slave” type device and it supports two functions of the protocol:

**Read Holding Registers (kod: 0x03 [hex], 03 [dec])** – reading values from one or more registers.

**Write Multiple registers (kod: 0x10 [hex], 16 [dec])** – changing values in one or more registers.

#### 3.6.1 Table of Modbus RTU protocol registers

In table 3 you will find a list of 2-byte memory registers of the controller used for communication via the Modbus RTU protocol. You can read the value of all the registers listed in the table using the “Read Holding Registers” function (“R” symbol). Those registers, whose value can be changed using the “Write Multiple Registers” function, are marked with a “W” symbol. Typically, a group of registers consists of 48 registers, which amounts to the maximum number of devices that the controller can support. If a group consists of 48 registers (e.g. 0x0000 – 0x002F), the first register in that group is assigned to the first device on the list of devices supported by the controller. The rest of the registers are assigned accordingly, each to a subsequent device on the list. Also, there are two groups which consist of 4 registers and one which consists of 8 registers.

The “Value” column shows values assumed by the registers in each group. Inside the square brackets you will find names of columns in which those values are presented in the ABAX 2 Soft program (see “Devices status”).

Group of registers	Value	R/W
0x0000 – 0x002F (0 – 47)	<b>Device status information [State]</b> Registers can assume values 0x0000 (0) or 0x0001 (1). Depending on the type of device, registers assume value 0x0001 (1) in the following cases: <ul style="list-style-type: none"> <li>• detector: alarm,</li> <li>• siren: signaling triggered,</li> <li>• expander of wired zones/outputs: zone activated,</li> <li>• ASW-200 smart plug: button pressed / relay turned on (230 VAC power ON),</li> <li>• ASW-210 controller: input activated / relay turned on (230 VAC power ON),</li> <li>• radiator thermostat: radiator valve open (in position other than fully closed).</li> </ul>	R

Group of registers	Value	R/W
0x0100 – 0x012F (256 – 303)	<b>Tamper information [TMP] / Information about anti-freeze protection (ART-200 thermostat)</b> Registers can assume value: 0x0000 (0) – no tamper / anti-freeze protection is not activated, 0x0001 (1) – tamper / anti-freeze protection is activated.	R
0x0200 – 0x022F (512 – 559)	<b>Information about radio communication between device and controller [Comm.] / Information about ART-200 thermostat error</b> Registers can assume value: 0x0000 (0) – communication OK / ART-200 thermostat operation OK, 0x0001 (1) – no communication for the time defined by the “Communication period” / “ECO” and “Filter” parameters / ART-200 thermostat error (problem with changing the valve position [F01] / wrong calibration [F02] / low battery [F03]).	R
0x0300 – 0x032F (768 – 815)	<b>Information about the device power state [Pow.]</b> Registers can assume value: 0x0000 (0) – power OK, 0x0001 (1) – power trouble (e.g. low battery).	R
0x0400 – 0x042F (1024 – 1071)	<b>Detector operating mode [Act.] / ART-200 thermostat operating mode</b> Registers can assume value: 0x0000 (0) – detector works in passive mode / thermostat works in “Economic temperature” mode, 0x0001 (1) – detector works in active mode / thermostat works in “Comfortable temperature” mode.	R/W
0x0500 – 0x052F (1280 – 1327)	<b>Device control [State]</b> Registers can assume values 0x0000 (0) or 0x0001 (1). If register assumes value 0x0001 (1): <ul style="list-style-type: none"> <li>• siren: signaling is triggered,</li> <li>• expander of wired zones/outputs: output is activated,</li> <li>• ASW-200 smart plug: relay is turned on (connected device is on),</li> <li>• ASW-210 controller: relay is turned on (power is on).</li> </ul>	R/W
0x0600 – 0x062F (1536 – 1583)	<b>Temperature registered by the temperature sensor in the device [Temperature]</b> Temperature is registered in the range of -10°C to +50°C with 0.5° accuracy. Registers can assume integer values preceded by a sign. For the purpose of conversion, registered temperatures are multiplied by 10, e.g. for temperature +23.5°C the register assumes value +235.	R

Group of registers	Value	R/W
0x0700 – 0x072F (1792 – 1839)	<p><b>Level of the radio signal received from the device by the controller [RSSI ACU]</b></p> <p>Level of signal is registered in %. Registers can assume values from 0 to 100.</p>	R
0x0800 – 0x082F (2048 – 2095)	<p><b>Level of the radio signal received by the device from the controller [RSSI dev.]</b></p> <p>Level of signal is registered in %. Registers can assume values from 0 to 100.</p>	R
0x0900 – 0x092F (2304 – 2351)	<p><b>Value of the supply voltage [Pow. volt.]</b></p> <p>Value of voltage supplied to devices supported by the controller is registered in mV, e.g. for voltage of 3.06 V the register assumes value 3060.</p>	R
0x0A00 – 0x0A03 (2560 – 2563)	<p><b>Information about active keyfob</b></p> <p>Read values from 4 registers:</p> <p>0x0A00 – keyfob number in the controller (1 – 256),</p> <p>0x0A01 – number of transmissions received from the keyfob by the controller,</p> <p>0x0A02 – number of pressed button (0 – 5),</p> <p>0x0A03 – battery status (0 – battery OK; 1 – low battery).</p> <p>The above-mentioned registers assume values greater than 0 only when the controller receives a transmission from the keyfob.</p>	R
0x0B00 – 0x0B2F (2816 – 2863)	<p><b>ASW-200 smart plug supply voltage</b></p> <p>Value of voltage supplied to ASW-200 plugs supported by the controller. Registered values of AC voltage are multiplied by 10, e.g. for voltage of 229.5 VAC the register assumes value 2295.</p>	R
0x0C00 – 0x0C2F (3072 – 3119)	<p><b>Current consumption by device connected to ASW-200 smart plug</b></p> <p>Value of current consumed by devices connected to ASW-200 plugs. Registered values are multiplied by 100, e.g. for current of 7.15 A the register assumes value 715.</p>	R
0x0D00 – 0x0D07 (3328 – 3335)	<p><b>Controller output state</b></p> <p>Registers can assume values:</p> <p>0x0000 (0) – output in normal state,</p> <p>0x0001 (1) – output activated.</p> <p>The first register in the group is assigned to the first output of the controller (OUT1), the subsequent registers are assigned respectively to the remaining outputs (OUT2 – OUT8).</p>	R/W

Group of registers	Value	R/W
0x0D08 – 0x0D0B (3336 – 3339)	<b>Controller input state</b> Registers can assume values: 0x0000 (0) – input in normal state, 0x0001 (1) – input activated. The first register in the group is assigned to the first input of the controller (AR1), the subsequent registers are assigned respectively to the remaining inputs (AR2 – AR4).	R
0x0E00 – 0x0E2F (3584 – 3631)	<b>Economy temperature (ART-200 thermostat)</b> Temperature is read / registered in the range of 5°C to +35°C with 0.5° accuracy. Registers can assume integer values preceded by a sign. For the purpose of conversion, registered temperatures are multiplied by 10, e.g. for temperature +23.5°C the register assumes value +235.	R/W
0x0F00 – 0x0F2F (3840 – 3887)	<b>Comfort temperature (ART-200 thermostat)</b> Temperature is read / registered in the range of 5°C to +35°C with 0.5° accuracy. Registers can assume integer values preceded by a sign. For the purpose of conversion, registered temperatures are multiplied by 10, e.g. for temperature +23.5°C the register assumes value +235.	R/W
0x1000 – 0x102F (4096 – 4143)	<b>ART-200 thermostat control using the Modbus RTU protocol</b> Registers can assume values: 0x0000 (0) – control using the Modbus RTU protocol disabled. The thermostat operates according to the selected mode. 0x0001 (1) – control using the Modbus RTU protocol enabled. The thermostat operating modes are not used. The thermostat keys are disabled.	R/W
0x1100 – 0x112F (4352 – 4399)	<b>Radiator valve position (ART-200 thermostat)</b> Radiator valve position is read / set in the range of 0% to 100%.	R/W

Table 3.

## 4 Installation of the controller



**Disconnect power before making any electrical connections.**

**Be careful during installation to avoid damage to the components located on the controller electronics board.**

### 4.1 Selecting a mounting location

The controller should be installed indoors, in spaces with normal air humidity. Prior to installation you should plan the arrangement of all ABAX 2 wireless devices which are to be operated by the controller. Select the installation place so that these devices are located within the controller operating range. Remember that thick walls, metal partitions, etc. will reduce the range of the radio signal. It is recommended that the controller be mounted high above the floor. This will allow you to get a better range of radio communication and avoid the risk of the controller being accidentally covered by people moving around the premises.



Installing the device in close vicinity of electrical systems is not recommended, since it can adversely affect the range of radio signal.

Several ABAX 2 / ABAX wireless system controllers can work within each other's range. The number of wireless devices working within each other's operating range depends on the frequency of periodical communication. The higher the frequency of communication, the lesser number of devices can work within each other's range.

## 4.2 Preparing the cabling

Run the cables to be used to connect the controller to the control panel or other devices to the controller's installation location. For power cables, use flexible conductors with cross-sectional area of 0.5-0.75 mm<sup>2</sup>. In order to connect the controller to the RS-485 communication bus, use the twisted-pair type of cable (e.g. UTP – unshielded twisted pair). Do not lay the cables in immediate vicinity of the low-voltage electrical network wires, especially those used for powering the high-power equipment (such as electric motors).

## 4.3 Installation of enclosure

The ACU-220 controller is sold complete with the OPU-1A enclosure.

1. Loosen the screws locking the enclosure cover and remove the cover (Fig. 6).
2. Remove the fastening screws of electronics board and remove the electronics board.
3. Place the enclosure base against the wall and mark location of the mounting holes. Set the enclosure so that the cable entry opening is situated at the bottom of the enclosure or at the base.

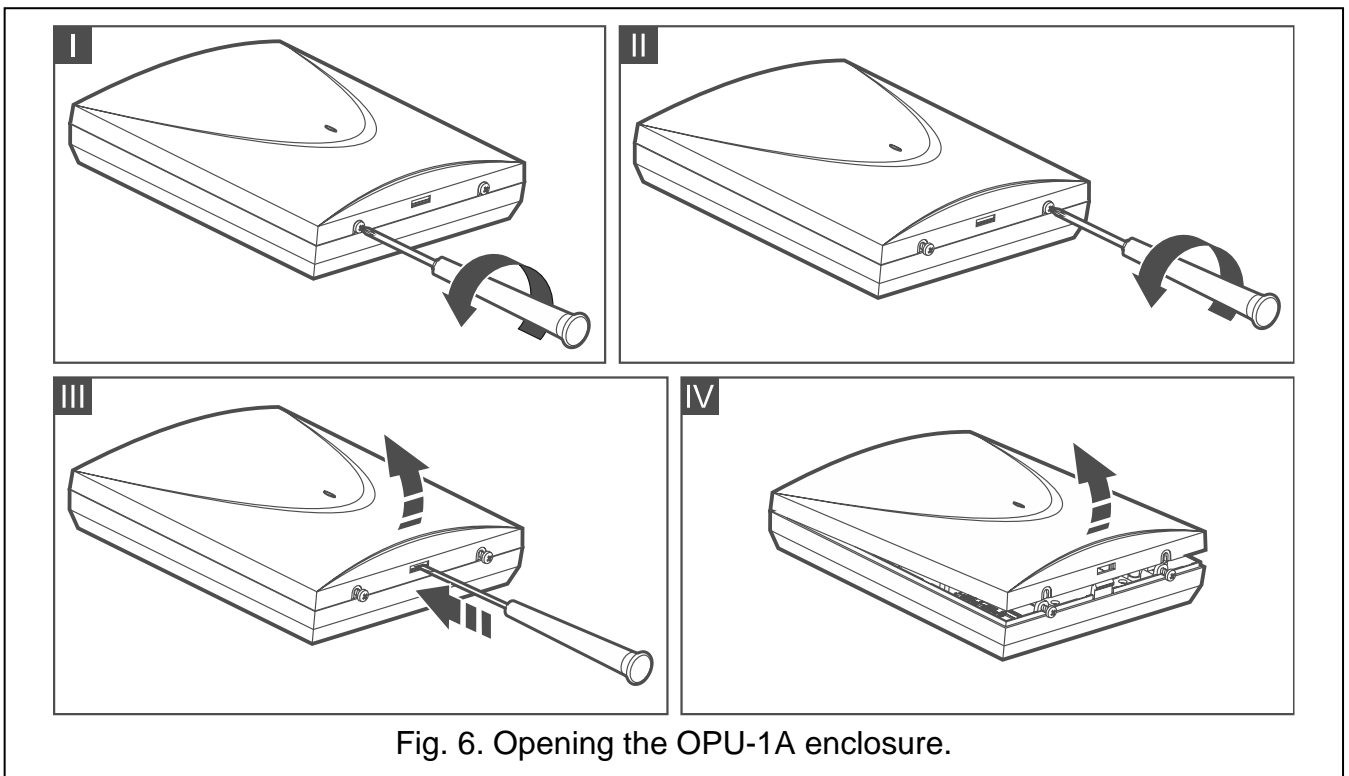

4. Drill holes for wall plugs (anchors) in the wall.
5. Make the cable entry opening at the base. The opening diameter must be larger than 10 mm. The finished opening must not have sharp edges.
6. Run the cables through the prepared opening (power cables, cables connecting the controller with the control panel or other devices, etc.).

7. Using wall plugs and screws, secure the enclosure base to the wall. Proper wall plugs must be selected for the type of mounting surface (different for concrete or brick wall, different for plaster wall, etc.). When installed, the device must withstand a pull-off force of at least 50 N.
8. Using screws, install the electronics board in the enclosure.

#### 4.4 Setting DIP switches

Using the DIP switches (see "DIP-switches" p. 7):

1. Define the controller operating mode (switches 9 and 10).
2. Select the transmitting antenna (switch 8).
3. Set the controller's address if the controller is to be connected to the INTEGRA series control panel (switches 1-5).

#### 4.5 Connecting the wires



*Protect the wiring against contact with sharp edges or else they can damage the insulation of cables.*

##### 4.5.1 Expander of wireless devices for SATEL alarm control panels

Depending on the alarm system in which the controller is to operate:

**INTEGRA:** connect the CKM, DTM, CKE, DTE and COM terminals to the corresponding terminals of the control panel communication buses (Fig. 7).

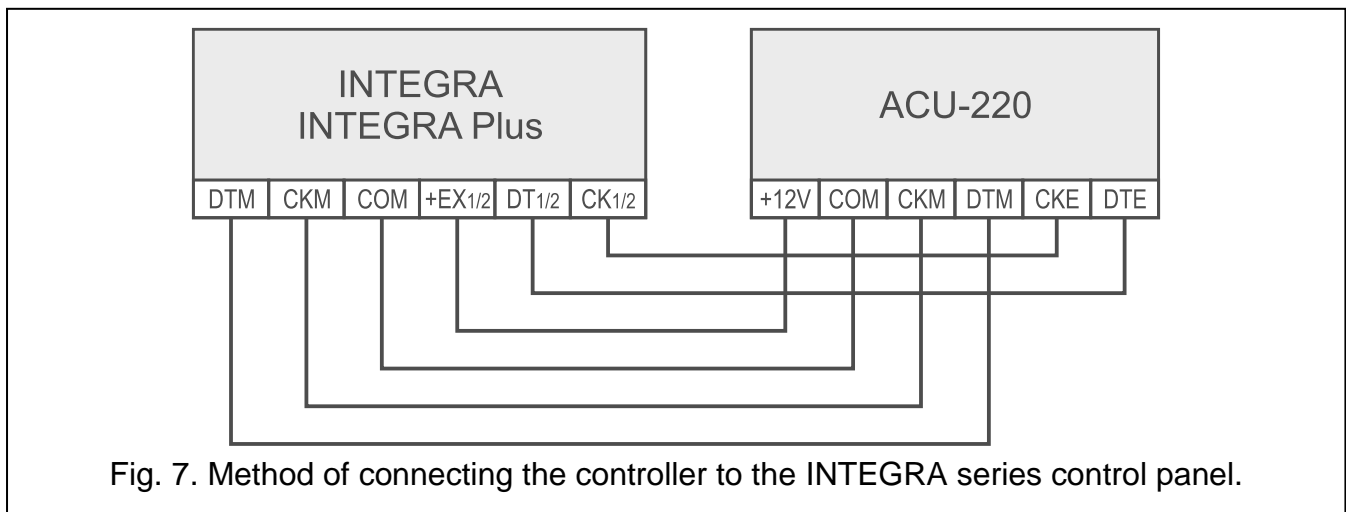

Fig. 7. Method of connecting the controller to the INTEGRA series control panel.

**VERSA:** connect the CKE, DTE and COM terminals to the corresponding terminals of the control panel communication bus (Fig. 8).

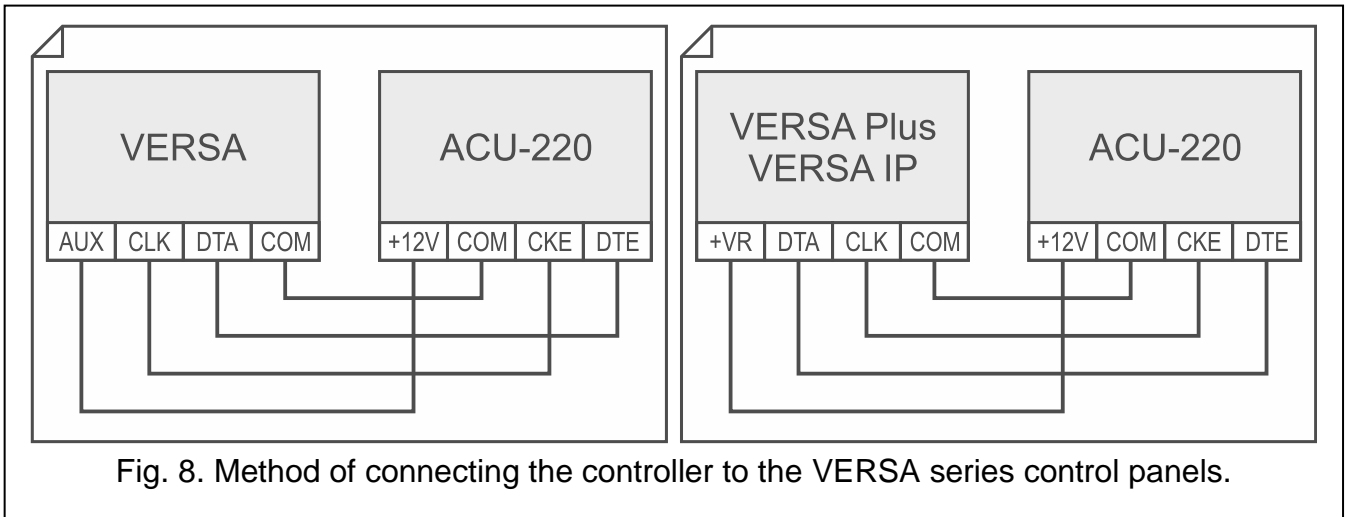

Fig. 8. Method of connecting the controller to the VERSA series control panels.

**PERFECTA 64 M:** connect the CKE, DTE and COM terminals to the corresponding terminals of the control panel communication bus (Fig. 9).



*You can connect only one ABAX 2 controller to the PERFECTA 64 M control panel.*

*If the ACU-220 controller is connected to the PERFECTA 64 M control panel, do not connect the PERFECTA-RF module or the INT-RX-S expander to the control panel. The PERFECTA 64 M control panel can support only one of these devices.*

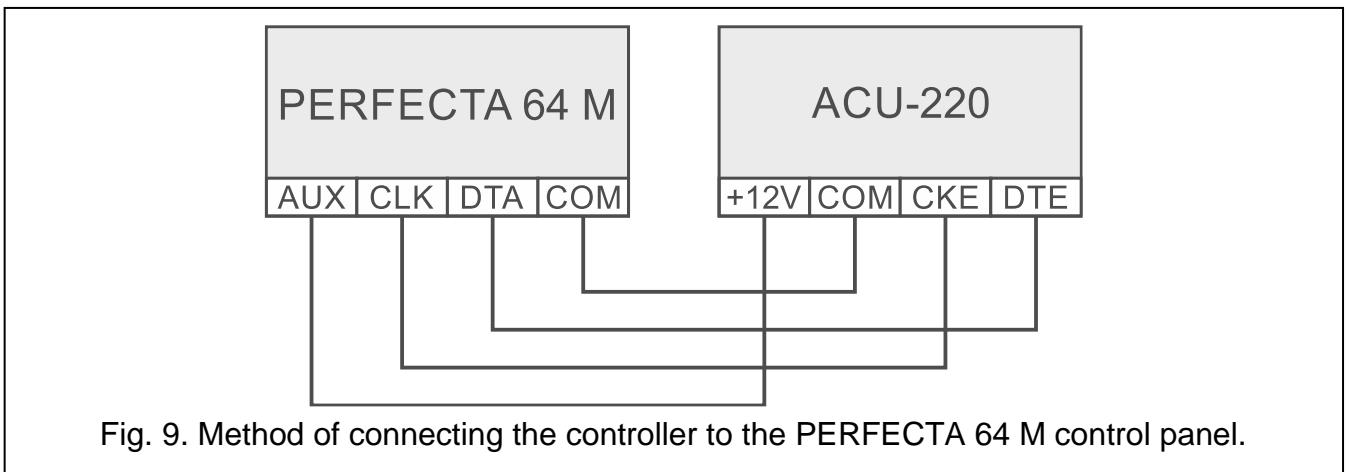

Fig. 9. Method of connecting the controller to the PERFECTA 64 M control panel.

If you use the twisted-pair type of cable, remember that the DTM and CKM / CKE and DTE (clock and data) signals must not be sent through one pair of twisted conductors. The conductors must be run in one cable.

Optionally, you can connect signaling devices to the outputs indicating problems in the ABAX 2 system.

## 4.5.2 Universal module of wireless devices

### 4.5.2.1 Connecting inputs and outputs of the controller

1. Connect the control input terminals to the control panel outputs or other device(s) that are to control the operation of wireless devices.
2. Connect the terminals of programmable outputs to the control panel zones or other device(s) that are to be controlled by the module.
3. Connect the terminals of outputs indicating problems in the ABAX 2 system to the control panel outputs or other device(s) to which the information about problems is to be sent.

### 4.5.2.2 Connecting the RS-485 bus

For connecting the RS-485 bus, connect the A and B terminals with the corresponding lines of the bus, as shown in figure 10.  $100\ \Omega$  ( $\pm 10\%$ ) resistors should be installed at the beginning and at the end of the bus. Connect the COM terminals of all devices connected to the bus with an additional wire. The maximum number of “Slave” type devices (e.g. ACU-220) that can be connected to the bus is  $n = 247$ .

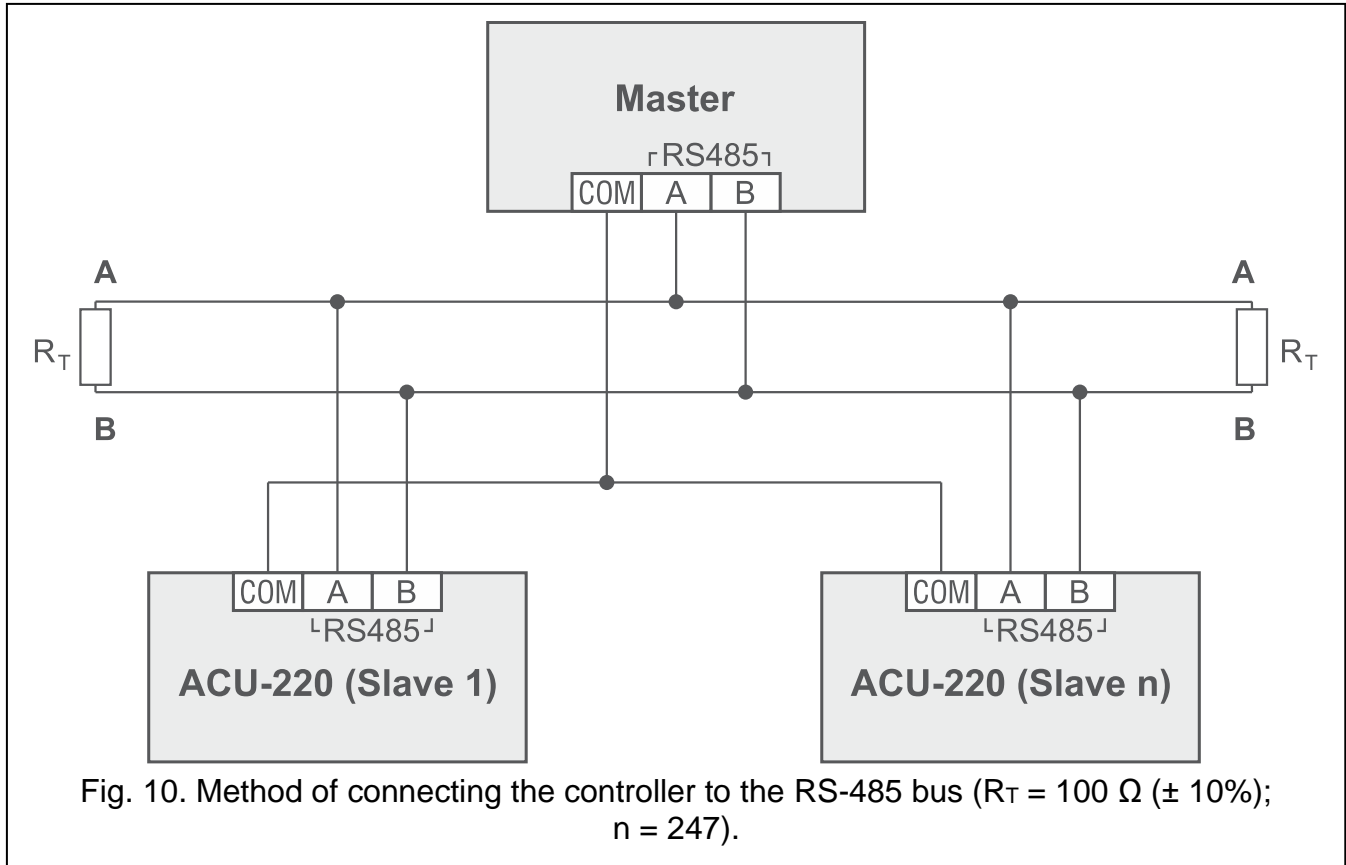

Fig. 10. Method of connecting the controller to the RS-485 bus ( $R_T = 100\ \Omega$  ( $\pm 10\%$ );  $n = 247$ ).

## 4.6 Powering on and starting the controller

1. Connect the power cables to the +12V and COM terminals. The controller may be powered directly from the control panel or from a power supply with current limitation up to 3 A.
2. Replace the cover and then lock it with the screws.
3. Turn the power on. The LED indicator should come on.



*If the controller works as expander of wireless devices for SATEL alarm control panels, run the identification function in the control panel (see the control panel installer manual). The controller will be identified as ACU-100.*

## 5 ABAX 2 Soft program

The ABAX 2 Soft program enables configuration and diagnostics of the wireless system when the controller works as universal module of wireless devices. The program can also be used for diagnostics of the system, when the controller works as expander for a SATEL control panel.

You can download the ABAX 2 Soft program from [www.satel.pl](http://www.satel.pl) website.

Required program version: 1.03.007 (or newer).

## 5.1 Description of the program

### 5.1.1 Menu bar in the program

The menu bar is displayed in the top part of the program window.

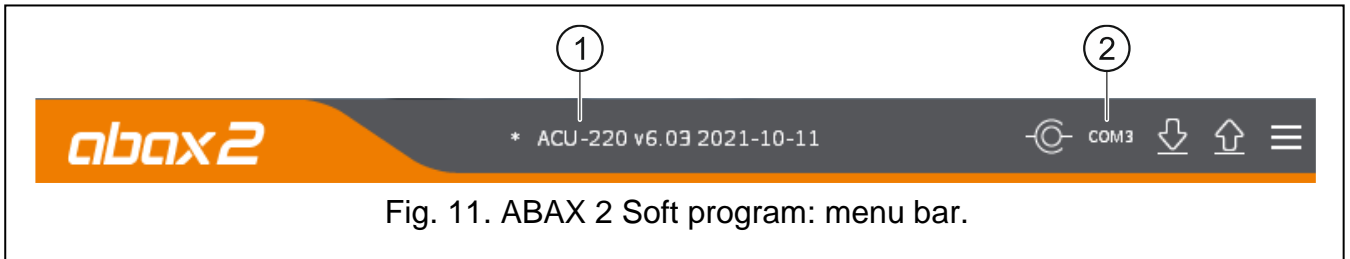

① type of controller and firmware version.

② number of the computer port used for communication with the RS-232 (TTL) port of the controller.

When the ABAX 2 system is running in the test mode, the “TEST MODE” information is displayed on the menu bar (after the firmware version).

#### Buttons



click to establish connection to the controller. The button is displayed when the program is not connected to the controller.



click to finish connection to the controller. The button is displayed when the program is connected to the controller.



click to read data from the controller.



click to write data to the controller.



click to display additional menu.

### 5.1.2 Additional menu

The additional menu is displayed after you click .

**Open** – click to open the controller data file.

**Save** – click to write the controller data to file.

**Configuration** – click to open the “Connection” window.

**Language** – click to open the “Software language” window.

**About** – click to display information about the program.

#### “Connection” window

**Port RS-232** – computer COM port to be used for communication with the RS-232 (TTL) port of the controller.

**OK** – click to confirm the changes.

**Cancel** – click to close window without saving changes.

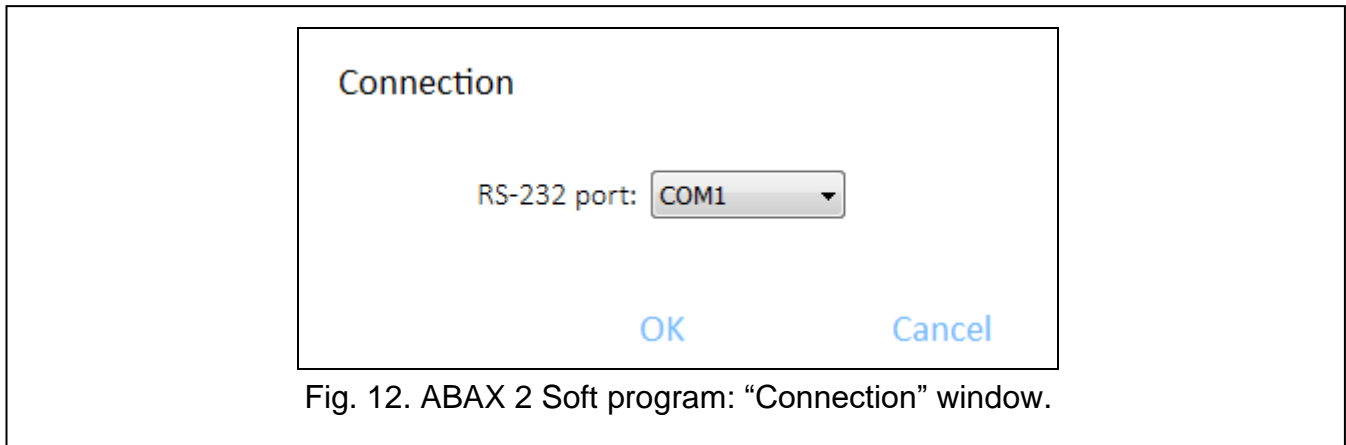

Fig. 12. ABAX 2 Soft program: “Connection” window.

### “Software language” window

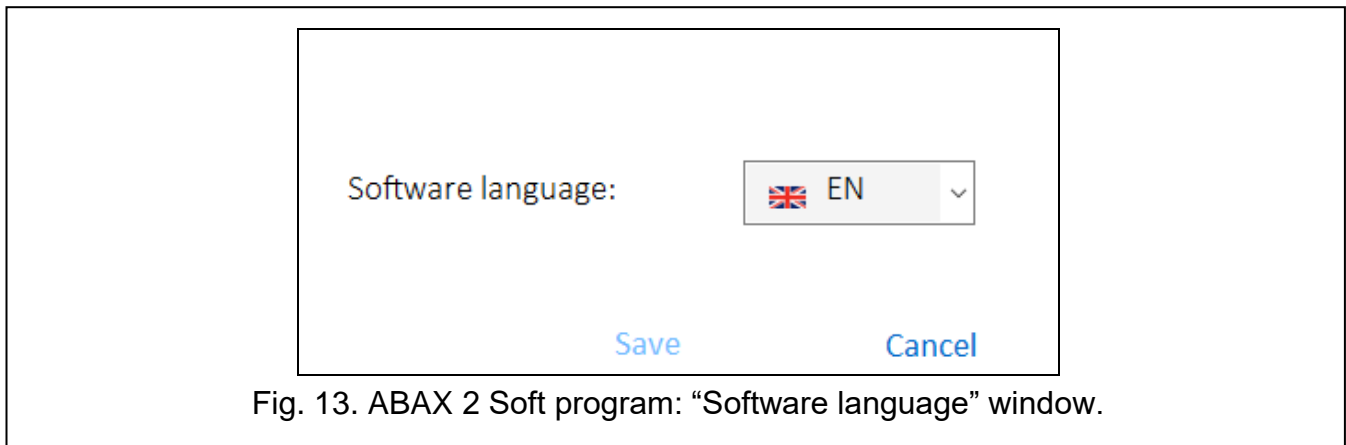

Fig. 13. ABAX 2 Soft program: “Software language” window.



**Software language** – you can select the language of the program.

**Save** – click to confirm the changes.

**Cancel** – click to close window without saving changes.

## 5.2 Establishing connection between the program and the controller

---

1. Connect the controller RS-232 (TTL) port with the computer port using the USB-RS converter offered by SATEL.
2. Select the computer COM port to be used for communication with the controller (see ““Connection” window” p. 19).
3. Click  on the menu bar.
4. After connection is established, information about the controller type and firmware version as well as the  button will be displayed on the program menu bar.

## 5.3 Configuration

---

### Controller info

**Module type** – controller type.

**Version** – firmware version of the controller.

**Serial number** – serial number of the controller.

**Communication period** – define the time intervals at which wireless devices are to communicate with the controller. Periodical communication can take place every 12, 24 or 36 seconds. During periodical communication, the devices inform the controller about their

status, and the controller sends commands to the devices (switches the detectors into active/passive mode, starts/ends test mode, changes configuration of the devices, etc.). The communication period has effect on the level of energy consumption by wireless devices: the less frequent is the communication, the lower is the energy consumption. For the battery-operated devices it means longer battery life. Moreover, when the communication takes place less frequently, more wireless devices can work within each other's operating range.

**i** If you enable the “ECO” option for a wireless device, periodical communication between that device and the controller will take place every 3 minutes (the “Communication period” parameter will have no effect on the device operation).

Some information and commands need to be sent immediately. Therefore, additional communication takes place when the device reports tamper, when the detector reports alarm, etc.

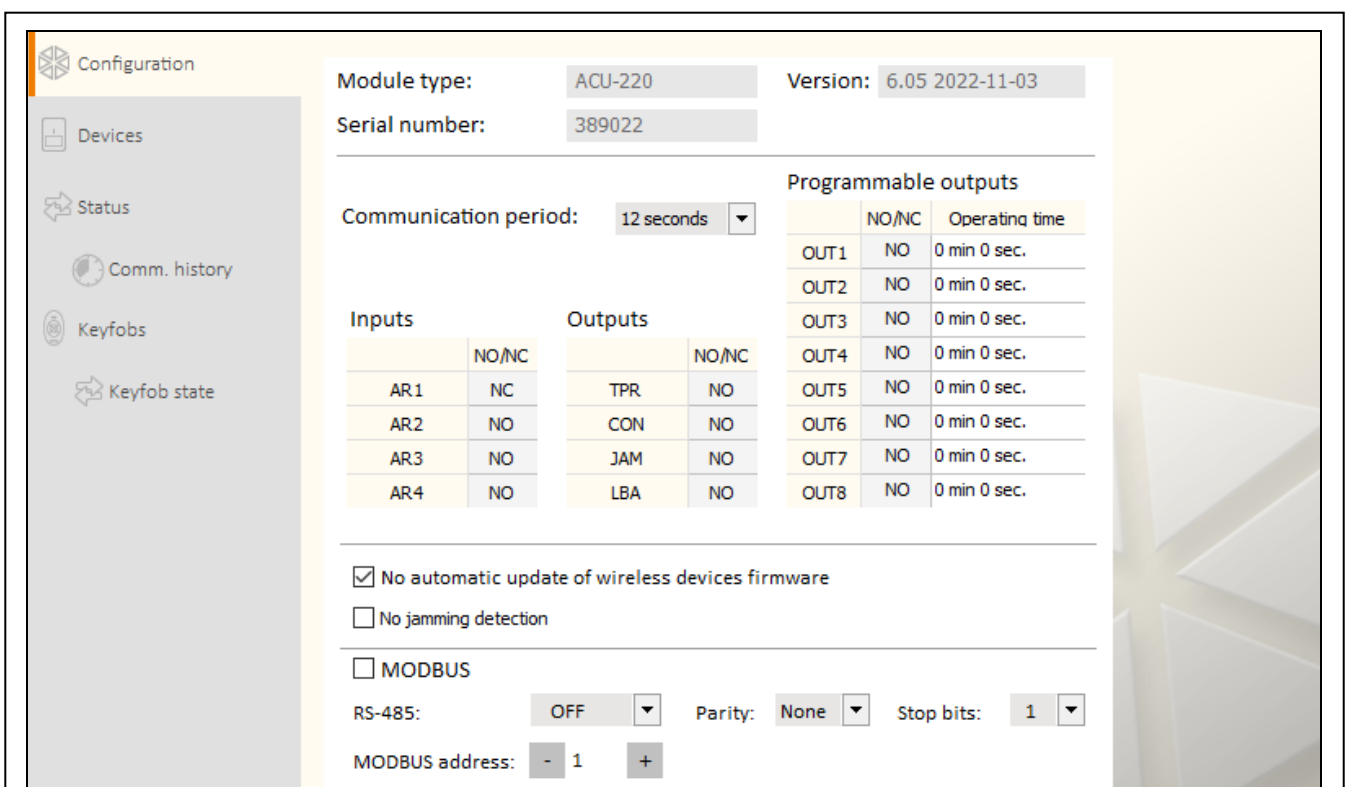

Fig. 14. ABAX 2 Soft program: “Configuration” tab.

**Inputs**

See “Control inputs” p. 10.

**NO/NC** – input type. You can select NO (activated when shorted to common ground) or NC (activated when opened). Click twice on the field to change the type.

**Outputs**

See “Outputs indicating problems in the ABAX 2 system” p. 9.

**NO/NC** – output type. You can select NO (normally open) or NC (normally closed). Click twice on the field to change the type.

**Programmable outputs**

See “Programmable outputs” p. 10.

**NO/NC** – output type. You can select NO (normally open) or NC (normally closed). Click twice on the field to change the type.

**Operating time** – the time during which the output is turned on. Operating time shorter than 2 minutes can be programmed to 1 second accuracy. A longer operating time is rounded up to full minutes. If you program 0, the output will remain turned on until it is turned off.

**No automatic update of wireless devices firmware** – if this option is enabled, firmware of the wireless devices registered to the controller is not updated automatically (see “Updating the firmware of ABAX 2 wireless devices” p. 78).

**No jamming detection** – if this option is enabled, the controller will not detect radio communication jamming.

**MODBUS** – if this option is enabled, the controller will be able to communicate with other systems using the Modbus RTU protocol (the RS-485 port is enabled).

**RS-485** – operation parameters of the RS-485 port. If you select OFF (default value), the port will be disabled. If you select any of the data transfer rates, the port will be enabled.

**i** *If the port is enabled:*

- *it is possible to integrate the controller with other systems (see „RS-485 bus” p. 11). The Modbus RTU protocol is used for communication.*
- *control inputs are not supported.*

**Parity** – type of data transmission check. Default: “None”.

**Stop bits** – stop bit length: 1, 1,5 or 2. Default: 1.

**MODBUS address** – individual address of the controller on the RS-485 bus. You can enter values from 1 to 247.

## 5.4 Devices

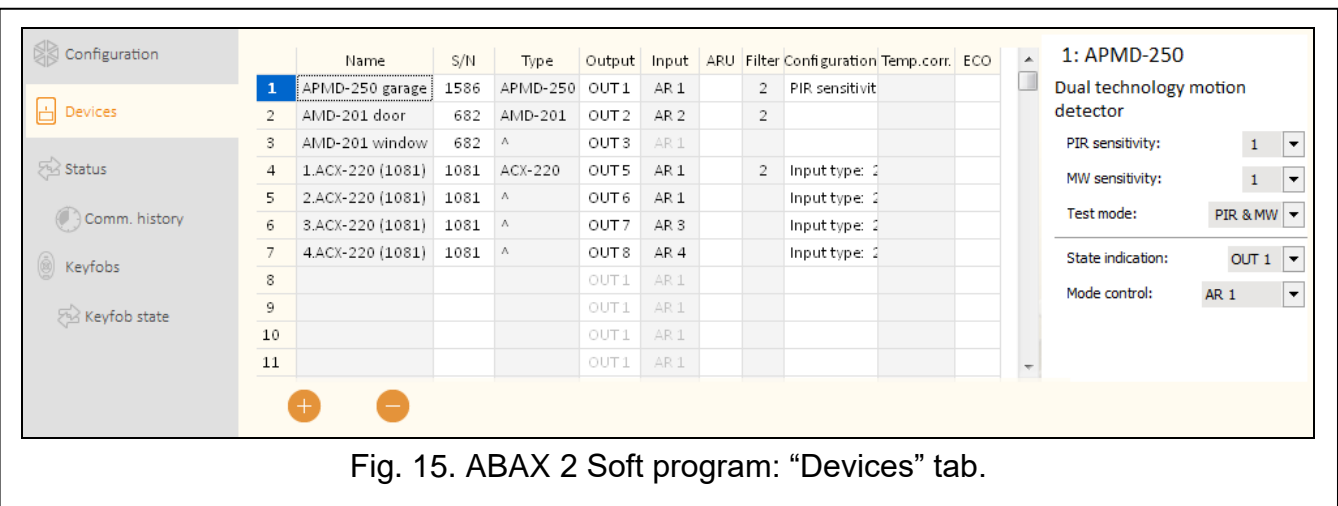

Fig. 15. ABAX 2 Soft program: “Devices” tab.

**Name** – individual device name (up to 16 characters). You can enter a name that will make it easier to figure out the location or intended purpose of the device.

**S/N** – serial number of the device.

**Type** – type of the wireless device. If the device takes up more than 1 position on the list, the “^” character is displayed in consecutive positions.

**Output** – controller output indicating the device status (see “Programmable outputs” p. 10). In the column, you can enter the number of output from 1 to 8.

**Input** – controller input for the control of wireless device (see “Control inputs” p. 10). In the column, you can enter the number of input (from 1 to 4) or letter “z” (detector always



active). The “Always active” option is available for most wireless detectors. It enables the detector to be switched into the active mode permanently (see “Wireless detectors” p. 69).

**ARU** – parameter available for the wireless device, if the ARU-200 radio signal repeater is registered to the controller. It defines whether the device is to communicate with the controller directly or via the selected ARU-200 radio signal repeater (a few ARU-200 radio signal repeaters can be registered to the controller). Leave this field blank if the device is to communicate directly with the controller. If the device is to communicate with the controller via the radio signal repeater, enter the number of position occupied by the radio signal repeater on the list of wireless devices (the radio signal repeater takes up two positions on the device list – enter the number of the first of them).

**Filter** – the number of consecutive communication periods without connection between the device and the controller after which loss of communication with the device will be reported. You can enter values from 0 to 255. Entering 0 disables the check for device presence in the system.



*If the system is to meet the EN 50131 requirements for Grade 2, loss of communication with the device must be reported within 20 minutes at the latest. Therefore, when entering the number take into account the frequency of periodical communication (“Communication period” parameter or “ECO” option).*

**Configuration** – for some devices, you can configure additional settings and options (see “Programming devices using the ABAX 2 Soft program” p. 65).

**Temp.corr.** – you can correct the temperature information sent by the device by up to  $\pm 3.5^{\circ}\text{C}$ .

**ECO** – if this option is enabled, periodical communication with the device takes place every 3 minutes. Thus the battery life can be extended up to four times.



*Remember that with the “ECO” option enabled for:*

*detector – delay between the change of control input state and switch-over of the detector operating mode (active/passive) can be up to three minutes,*

*ASP-215 siren – delay in starting / stopping the signaling can be up to three minutes.*

## Buttons



click to add new device (see “Adding new wireless devices” p. 42).



click to remove selected device (see “Removing wireless devices” p. 42).

---

### 5.5 Status

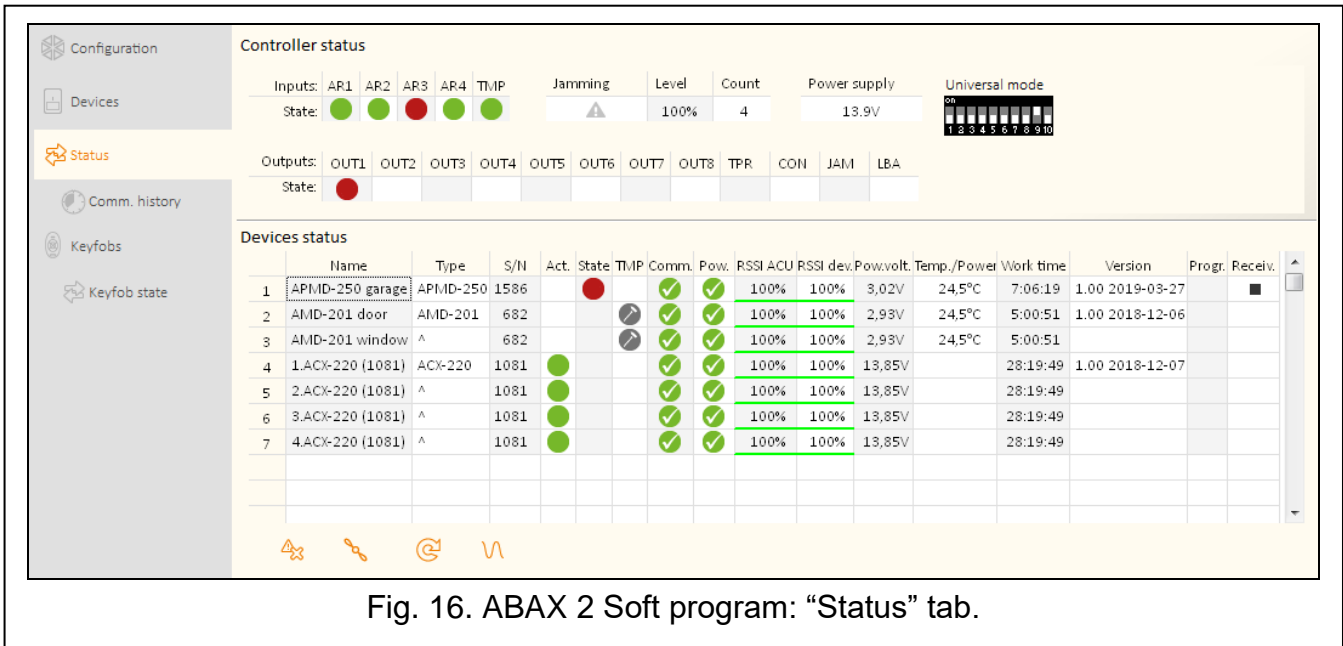

Fig. 16. ABAX 2 Soft program: "Status" tab.

#### Controller status

##### Inputs

Information about the state of controller inputs:

- [green] – input in normal state.
- [red] – input activated.

##### Jamming

Information about radio communication jamming:

- ⚠ [yellow] – communication is jammed,
- ⚠ [gray] – communication was jammed.

**Level** – level of radio communication jamming signal.

**Count** – number of radio communication jamming cases.

##### Power supply

Information about current supply voltage of the controller.

##### DIP-switches

Graphic information about setting of DIP-switches.

##### Outputs

Information about the state of controller outputs:

- [blank] – output in normal state.
- [red] – output active.

##### Devices status

**Name** – individual device name.

**Type** – device type. If the device takes up more than 1 position on the list, the “^” character is displayed in successive positions.

**S/N** – serial number of the device.



**Act.** –  [green] icon indicates that:

- detector: working in active mode,
- another device: running (does not apply to the ART-200 thermostat).



**State** –  [red] icon indicates that:

- detector: alarm,
- siren: signaling triggered,
- expander of wired zones/outputs: input activated,
- ASW-200 smart plug: button pressed / relay turned on (230 VAC power ON),
- ASW-210 controller: input activated / relay turned on (230 VAC power ON).
- ART-200 radiator thermostat: radiator valve open (in position other than fully closed).



**TMP** – tamper information / information about anti-freeze protection (ART-200 thermostat):

-  [red] – tamper / anti-freeze protection is activated,
-  [gray] – tamper memory / memory of anti-freeze protection being activated.

**Comm.** – information about radio communication between the device and the controller:

-  [green] – communication OK,
-  [yellow] – no communication for the time defined by the “Communication period” / “ECO” and “Filter” parameters,
-  [gray] – trouble memory.

**Pow.** – information about the device power state:

-  [green] – power OK,
-  [yellow] – power trouble (e.g. low battery),
-  [gray] – power trouble memory.

**RSSI ACU** – level of the radio signal received from the device by the controller. Presented as percentage or in power units (dBm). Click twice the column to change the way of presentation.

**RSSI dev.** – level of the radio signal received by the device from the controller. Presented as percentage or in power units (dBm). Click twice the column to change the way of presentation.

**Pow.volt.** – value of the supply voltage.

**Temp./Power** – temperature registered by the temperature sensor in the device / power consumed by the device connected to the ASW-200 smart plug.





**Work time** – work time of the device. The time is counted from the moment of the device being registered to the controller, or restart of the device.

**Version** – firmware version of the device and build date. The orange font indicates that a new firmware version is available (see “Updating the firmware of ABAX 2 wireless devices” p. 78). The  [yellow] icon displayed in the field means that the firmware update attempts have failed.

**Progr.** – percentage value indicating progress of the device firmware update.

**Receiv.** – the  [black] icon indicates that the controller has just received a transmission from the device.

### Buttons

	click to clear trouble memory / restart the process of device firmware update.
	click to start the test mode in the ABAX 2 system.
	click to end the test mode in the ABAX 2 system.
	click to refresh information about the supported devices.
	click to display the graphs window (see "Graphs").

### 5.5.1 Graphs

Presented in the form of graphs are radio signal levels on four channels used by the ABAX 2 system. They allow you to check whether other radio devices that may interfere with communication are working on this channel and what is the radio noise level. If there are any undesired radio signals which are comparable to or stronger than the signals from the ABAX 2 system, they will interfere with the system operation. This may result in a periodic loss of communication as well as quicker draining of the battery in wireless devices.

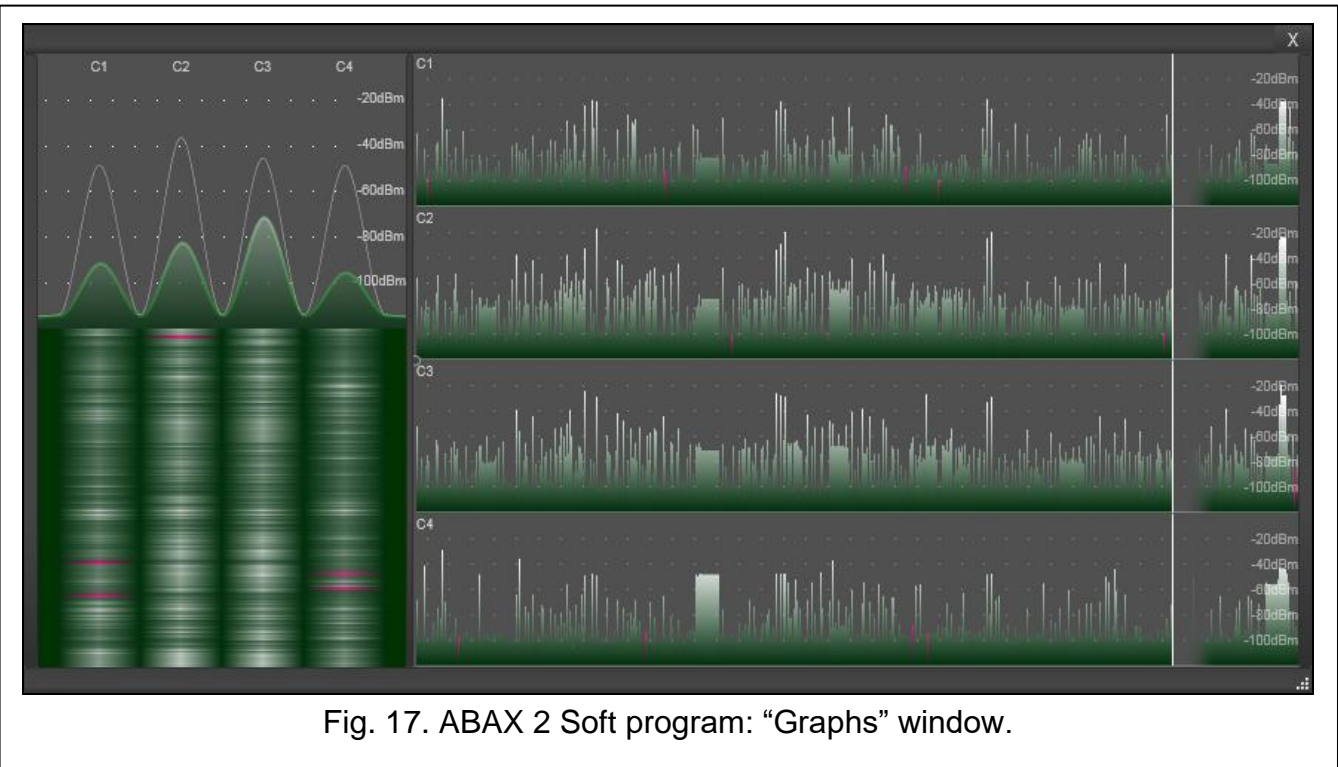

### 5.5.2 Comm. history

**Wireless device** – select a device from the list to display the graph showing the history of communication of that device with the controller.

 *The program collects data on communication history only when it is running.*

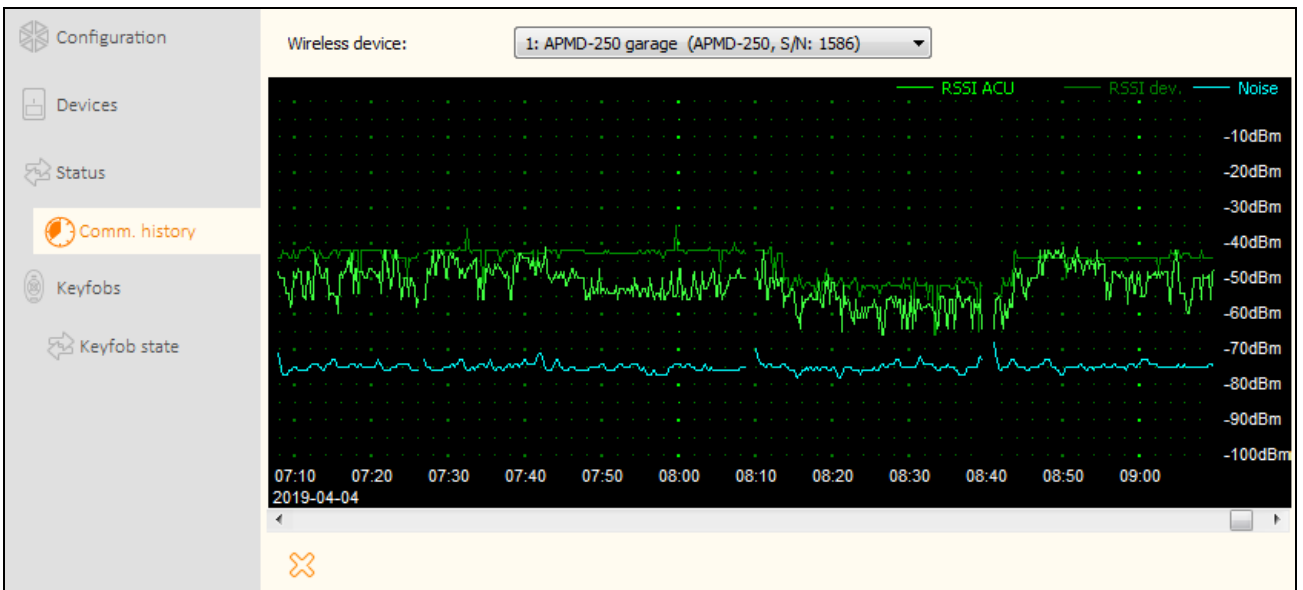

Fig. 18. ABAX 2 Soft program: “Comm. history” tab.

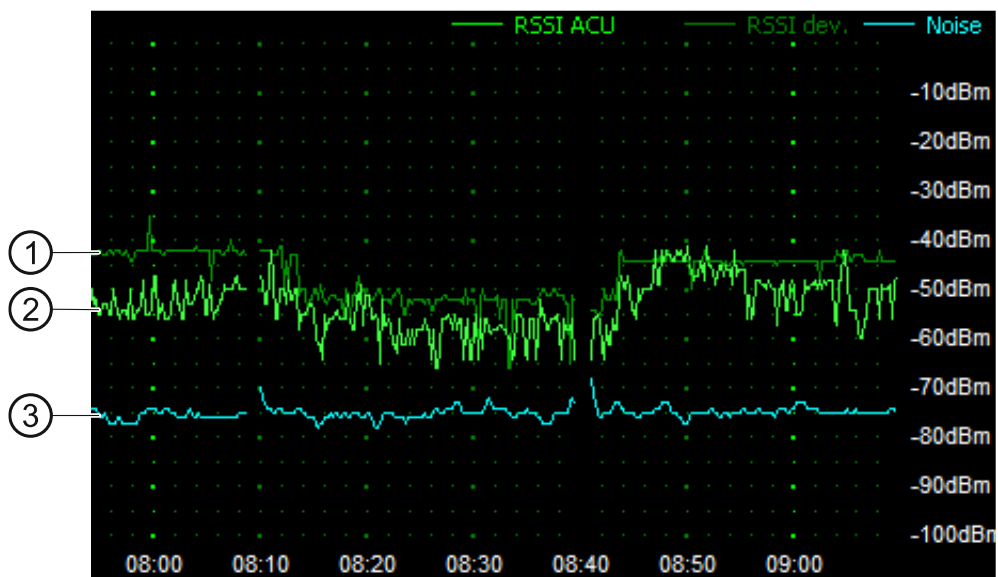



Fig. 19. A segment of graph showing communication history.

Legend to Fig. 19:

- ① dark-green – level of the radio signal received by the device from the controller.
- ② light-green – level of the radio signal received from the device by the controller.
- ③ blue – level of the interfering signal.

**Buttons**

-  click to clear the history of communication of the selected device with the controller. This will display a window where you can define the period the data from which are to be cleared.

## 5.6 Keyfobs

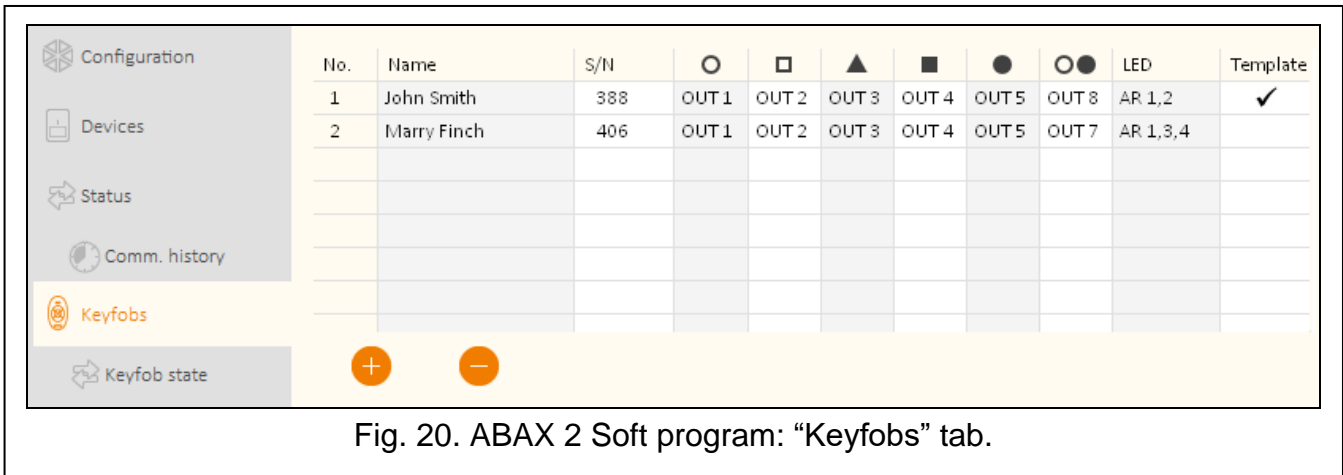

Fig. 20. ABAX 2 Soft program: “Keyfobs” tab.

**No.** – number of the keyfob on the list.

**Name** – individual keyfob name (up to 16 characters). You can enter a name that identifies the keyfob user.

**S/N** – serial number of the keyfob.

**Keyfob buttons** – for each button (combination of buttons), you can enter the number of output to be controlled by the button (combination of buttons).

**LED** – you can enter 3 digits which correspond to the input numbers (from a range of 1 to 4). The state of these inputs will be presented by a few seconds on the keyfob LEDs after any button is pressed. You can thus get information about the system state.

**Template** – if this option is enabled, the keyfob settings are copied for each new keyfob registered to the controller. This reduces the time required for configuration of the new keyfobs.

### Buttons

 click to add new keyfob (see “Adding a keyfob” p. 77).

 click to remove selected keyfob (see “Removing a keyfob” p. 78).

### 5.6.1 Keyfob state

**Name** – individual keyfob name.

**S/N** – serial number of the keyfob.

**Batt.** – information about battery status:

 [green] – battery OK,

 [yellow] – low battery,

 [gray] – low battery memory.

**RSSI** – level of the radio signal received from the keyfob by the controller.

**Batt.volt.** – value of the battery voltage.

**Version** – keyfob firmware version and build date. The orange font indicates that a new firmware version is available (see “Updating the firmware of ABAX 2 wireless devices” p. 78). The  [yellow] icon displayed in the field means that the firmware update attempts have failed.

**Progr.** – percentage value indicating progress of the keyfob firmware update.

**Receiv.** – the ■ [black] icon indicates that the controller has just received a transmission from the device.

	Name	S/N	Batt.	RSSI	Batt.volt.	Version	Progr.	Receiv.
1	John Smith	388	✓	-37dBm	2.92V	1.00 2019-03-25		
2	Marry Finch	406	✓	-41dBm	3.01V	1.00 2019-03-25		

Fig. 21. ABAX 2 Soft Program: “Keyfob state” tab.

## Buttons



click to clear trouble memory / restart the process of keyfob firmware update.



click to refresh information about the supported keyfobs.

## 6 Wireless devices supported by the controller

The ABAX 2 wireless devices are divided into 3 categories:

- devices,
- keypads [expander of wireless devices for SATEL alarm control panels],
- keyfobs.

For each of these categories a separate pool of positions is provided in the controller.

### 6.1 Devices

#### Detectors

- ACD-220** - wireless curtain detector.
- ACMD-200** - wireless carbon monoxide detector.
- ADD-200** - wireless outdoor dusk and temperature detector.
- AGD-200** - wireless glass-break detector.
- A OCD-260** - wireless outdoor dual technology curtain detector.
- A OD-210** - wireless outdoor dual technology motion detector.
- APD-200** - wireless passive infrared detector.
- APD-200 Pet** - wireless passive infrared detector with pet immunity up to 20 kg.
- APMD-250** - wireless dual technology motion detector.
- ASD-200** - wireless smoke and heat detector.
- ASD-250** - wireless smoke detector.

- AXD-200** - wireless multipurpose detector, which can work as:
- AFD-200** - water flood detector,
  - AMD-200** - magnetic contact,
  - AMD-201** - dual channel magnetic contact,
  - AMD-202** - magnetic contact with input for roller shutter detector,
  - ARD-200** - reorientation detector,
  - ATD-200** - temperature detector,
  - AVD-200** - shock detector and magnetic contact,
  - ATX-220** - hardwired zone expander: 2 x NC,
  - ATX-230** - hardwired zone expander: NC and roller shutter.

### Sirens

- ASP-200** - wireless outdoor siren.
- ASP-215** - wireless indoor siren.

### Hardwired zone / output expanders

- ACX-210** - miniature hardwired zone / output expander.
- ACX-220** - hardwired zone / output expander.

### Controllers

- ASW-200** - smart plug.
- ASW-210** - flush-mounted wireless two-channel 230 VAC controller.

### Other devices

- APB -200** - wireless panic button.
- ARF-200** - radio signal level tester.
- ARU-200** - radio signal repeater.
- ART-200** - wireless radiator thermostat.

## 6.2 Keypads

---

**INT-KWRL2** – wireless keypad for the INTEGRA series control panels.

**PRF-LCD-A2** – wireless keypad for the PERFECTA 64 M control panel.

**VERSA-KWRL2** – wireless keypad for the VERSA series control panels.

## 6.3 Keyfob

---

**APT-200** – bidirectional keyfob.



| *Keyfobs are discussed in a separate section (p. 71).*

## 7 Installation of ABAX 2 wireless devices

---

After the controller has been installed, you can begin installation of the ABAX 2 wireless devices. Before installing a device, check the level of radio signal received by the device from controller and by the controller from device at the planned installation place. The ARF-200 tester is a useful tool to check the signal level. The level of signal received by device/controller may not be lower than 40%. You can only install the device at the planned location after making sure that the level of the radio signal is correct. If the radio signal level at the planned installation place is too low, select another installation location. Sometimes it



is sufficient to move the device ten or twenty centimeters to obtain a significant improvement of signal quality.

For detailed information about installation of individual devices, please refer to the manuals of the respective products.

## 7.1 Registering devices to the controller

The ABAX 2 wireless devices must be registered to the controller (only the ARF-200 tester can be supported when unregistered – see: “Enabling / disabling the support of the unregistered ARF-200 tester” p. 9).



*Before adding a device that was previously registered to the ABAX / ABAX 2 system, you must restart it (remove the battery / power the device off for 30 seconds).*

When registering a device, you must enter its serial number. The serial number sticker is affixed to the device (location of the sticker is indicated in the manual of the device). The serial number of each ARF-200 tester is 0000500.

When registered, some devices will occupy two or more positions on the list. Therefore, the actual number of devices that can be registered depends on how many positions will be taken up by individual devices. For example, the expander ACX-220 can take up 4 positions. After registering it to the controller, the pool of positions for further devices will decrease by 4 (e.g. if there were 48 positions available before registering the expander, 44 positions will remain after registering the expander, i.e. you will still be able to register up to 44 devices).



*In case of many devices that occupy two or more positions on the device list, you can select how many positions are to be occupied when registering them to the controller.*

*Data of the wireless devices are stored in the controller. If you connect a controller with registered wireless devices to the control panel, then after the devices are identified:*

- *keypads will be added to the system,*
- *wireless devices will be assigned to the system zones / outputs,*
- *keyfobs will be assigned to users.*

*This may cause problems (e.g. identification may be impossible due to conflicting addresses). For this reason, it is recommended not to connect a controller with registered devices to the control panel.*

### 7.1.1 Expander for the INTEGRA series control panels



*Most of the ABAX 2 wireless devices are identified in the alarm system by the names known from the ABAX system.*

*For information about registering the INT-KWRL2 keypad, consult the keypad manual.*

To add or delete devices, you can use the DLOADX program (version required: 1.21.000 or newer) or LCD keypad. For description of the DLOADX program and LCD keypads, refer to the control panel manuals.

The number of devices you can register to the controller depends on the control panel (INTEGRA 24 – up to 16; INTEGRA 32 – up to 24; other control panels – up to 48). Each position on the device list represents one wireless zone or one wireless zone and one output. When adding and removing the wireless devices, remember that the identification function registers zones and outputs by groups of 8. Already after adding one wireless device which takes up 1 zone, the control panel will reserve 8 zones in the system for wireless devices. The LCD keypad makes it possible to select the zone to which that device will be assigned.

Observe continuity, i.e. avoid leaving any gaps in the list, which will later reduce the number of available zones in the system. Remember to preserve continuity also when removing wireless devices. For example, if the devices registered in the controller occupy 9 positions on the list, then 16 zones (2x8) are reserved in the system. After removal of the device which occupied position 7 on the list, there will still be 16 zones (2x8) reserved in the system for wireless devices, although 8 positions are actually taken up on the list of wireless devices (see: Table 4). In such a case, it is recommended that the last devices be removed from the list and then added to the system again, so as to fill up the gap in the list and reduce the number of zones reserved for wireless devices.

In case of devices which, in addition to zones, also take up outputs, it is recommended that you add them to the system first. This will allow you to maintain the continuity of use of not the zones alone, but the outputs as well.

In some cases, the gaps in the list of zones/outputs cannot be avoided. It applies to situation when the number of zones/outputs, which is used by the devices, is not a multiple of 8.

ACU-220		INTEGRA / INTEGRA Plus				
It.	list of devices	zones		outputs		
		No	device	No	device	
1	APD-200 detector	8	17	APD-200 detector	17	unused/unavailable
2	APD-200 detector		18	APD-200 detector	18	unused/unavailable
3	AMD-200 detector		19	AMD-200 detector	19	unused/unavailable
4	AMD-200 detector		20	AMD-200 detector	20	unused/unavailable
5	AMD-201 detector		21	AMD-201 detector	21	unused/unavailable
6	^		22	AMD-201 detector	22	unused/unavailable
7			23	unused/unavailable	23	unused/unavailable
8	ASP-200 siren		24	ASP-200 siren	24	ASP-200 siren
9	^	8	25	ASP-200 siren	25	ASP-200 siren
10			26	unused/unavailable	26	unused/unavailable
11			27	unused/unavailable	27	unused/unavailable
12			28	unused/unavailable	28	unused/unavailable
13			29	unused/unavailable	29	unused/unavailable
14			30	unused/unavailable	30	unused/unavailable
15			31	unused/unavailable	31	unused/unavailable
16			32	unused/unavailable	32	unused/unavailable

Table 4.

For each group of 8 zones/outputs, one address on the expander bus is reserved. The controller can occupy from 1 to 6 addresses. This must be taken into account at the system design stage and sufficient number of free addresses must be left for the controller. If, when new wireless devices have been added to the controller, it turns out that next addresses are needed, and these are taken up by other devices, successful completion of the expander identification procedure will be impossible. It will be necessary to change addresses of the devices connected to the bus.

Table 4 shows how the wireless devices should not be registered. The first siren output takes up position 8, and the second output occupies position 9. As a result, 16 outputs have been reserved for wireless devices in the system, although actually only 2 are used (the eighth output in the first group of 8 outputs and the first output in the second group of 8 outputs). For devices taking up 8 positions, the system must reserve 16 zones and 16 outputs as well as 2 addresses. Table 5 shows an example of how to correctly register the same devices (compare also Fig. 22). For 8 devices, the system has reserved 8 zones and 8 outputs as well as 1 address.

ACU-220		INTEGRA / INTEGRA Plus			
It.	list of devices	zones		outputs	
		No	device	No	device
1	ASP-200 siren	17	ASP-200 siren	17	ASP-200 siren
2	^	18	ASP-200 siren	18	ASP-200 siren
3	APD-200 detector	19	APD-200 detector	19	unused/unavailable
4	APD-200 detector	20	APD-200 detector	20	unused/unavailable
5	AMD-200 detector	21	AMD-200 detector	21	unused/unavailable
6	AMD-200 detector	22	AMD-200 detector	22	unused/unavailable
7	AMD-201 detector	23	AMD-201 detector	23	unused/unavailable
8	^	24	AMD-201 detector	24	unused/unavailable

Table 5.

version: 6.06 2022-12-08 Module: ACU-120/270, address:13

Name: ACU-100 (2Dh)

Tamper signaled in part.: 1: Reception

No auto-reset after three module tamper alarms

Communication period:  12sec.  24sec.  36sec.

No jamming detection  No automatic update of wireless devices firmware

Zones/Outputs | INT-K/WRL

No.	Name	Type	Device type	Serial number	ARU	Always active	Configuration	Filter	Temp. corr.	ECO
1	OUT:41 Z:17 ASP-100 acoust.	Burglary	ASP-100 (siren)	0005650			1: Sound 1 2: time 3 min.	40		
2	OUT:42 Z:18 ASP-100 optic.	Burglary	^ (flash)							
3	Z:19 APD-100 corridor	Interior delayed (with TAMPER)	APD-100. (PIR PET)	0000345			1-0: Sensitivity 0		2.0°C	
4	Z:20 APD-100 l. room	Interior delayed (with TAMPER)	APD-100. (PIR PET)	0000639			1-0: Sensitivity 0		1.0°C	
5	Z:21 AMD-100 door	Entry/Exit (with TAMPER)	AMD-101.(Magn. contact)	0003829		X	0:Bottom cont 0		0.0°C	
6	Z:22 L. room window 1	Perimeter (with TAMPER)	^ (NC input)							
7	Z:23 L. room window 2	Perimeter (with TAMPER)	AMD-100.(Magn. contact)	0001934		X	1:Side contac 0		0.0°C	
8	Z:24 L. room window 3	Perimeter (with TAMPER)	AMD-100.(Magn. contact)	0000523			0:Bottom cont 0		0.0°C	

Fig. 22. DLOADX program: the list of wireless devices registered in the controller in the INTEGRA system.

### 7.1.1.1 Adding new wireless devices

#### DLOADX program

You can add a wireless device in the “Structure” window, “Hardware” tab, after clicking the name of the controller on the device list, and then on the “Zones/Outputs” tab

The device being added is assigned to zones and outputs automatically (to the first unoccupied zones / outputs from the pool reserved for the controller).

1. Click the “Read” button. The data related to wireless devices will be read from the controller (these data are not read after clicking the  button in the main menu).
2. Click the “New device” button.
3. The “New device” window will open.
4. Enter the serial number of the device being added in the “Serial number” field.
5. Power on the device (install the battery in the device, turn on the device power, etc.).

6. A message will confirm that the device has been added (unless you have entered an invalid serial number, of which the message will inform you).
  - 6.1. Device type will be displayed. For the AXD-200 multipurpose detector, you can select the device type.
 

**i** *If the device type you select is different from the type set before the AXD-200 detector was added to the system, the type will change during the periodical communication. It results in a delay whose duration depends on the frequency of periodical communication (with the “ECO” option enabled, delay can be up to 3 minutes).*
  - 6.2. A new name of the zone to which the device is to be assigned will be displayed. You can change the name. If the device occupies two or more positions on the device list, the same name will be given to the other zones. If the device is to be assigned to outputs, the outputs will be given the same name.
  - 6.3. For some devices you can select if the device is to occupy one or two positions on the list of devices.
7. Click the “OK” button.
8. The “New device” window will close.
9. The new device will be displayed on the list of devices.
10. Click the “identification” button (see Fig. 23). The new wireless zones / outputs will not be available in the alarm system until the procedure of expander identification is finished.

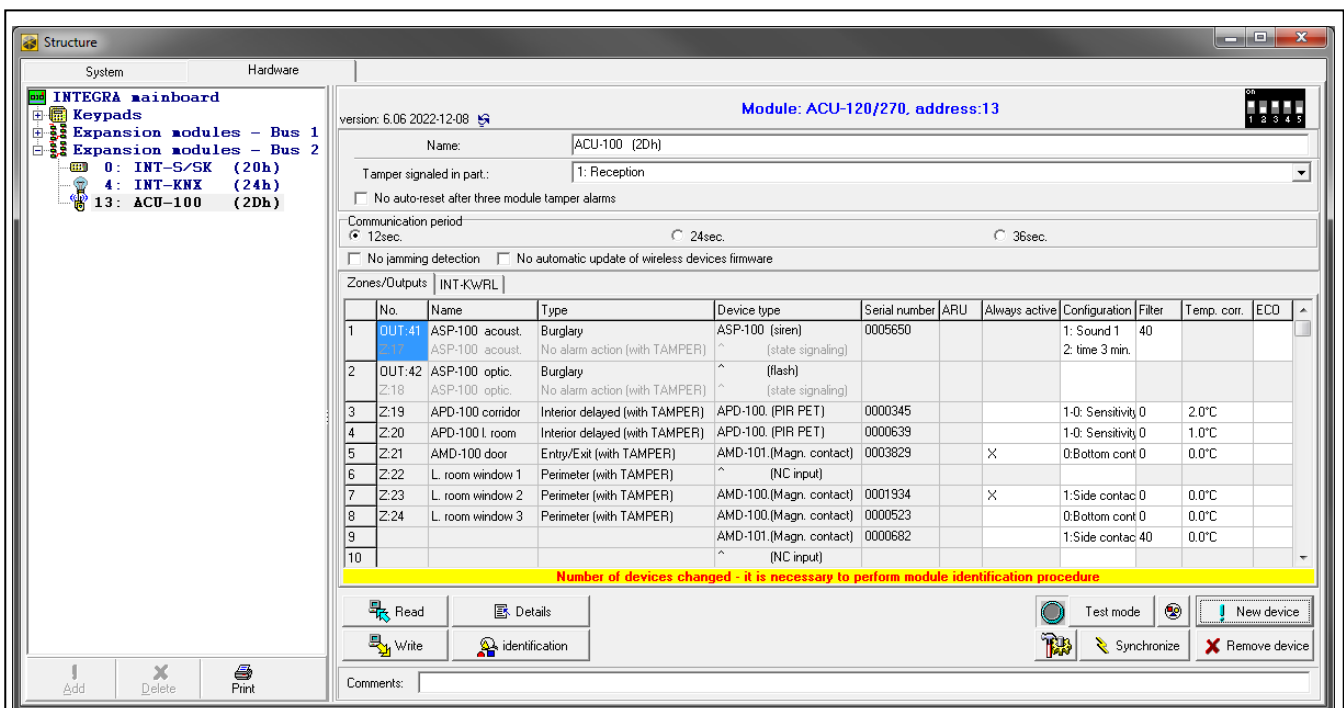

Fig. 23. DLOADX program: information displayed after registration of a new device to the controller in the INTEGRA system.

### LCD keypad

You can add wireless devices in service mode, using the “New device” function (►“Structure” ►“Hardware” ►“Expanders” ►“Settings” ►[controller name] ►“New device”).

When adding a device you can select the alarm system zone to which you want to assign the device. It can be one of the unoccupied zones from the pool reserved for the controller. If the device takes up more than one position on the list of devices, additional zones will be

assigned to the device automatically (these will be the zones following the selected one). To the outputs, the device is assigned automatically (to the first unoccupied outputs from the pool reserved for the controller).

1. Start the “New device” function.
2. When the “Device serial number:” is displayed, enter the serial number of the device being added.
3. Press **#**.
4. When the “Open device tamper” command is displayed, power on the device (insert the battery into the device, turn on the device power, etc.).
5. Type and serial number of the device will be displayed (if a message is displayed instead to inform you that the entered serial number is invalid or the device is already registered, press **\*** to quit the function).
6. Press the key 1.
7. If you can select whether the device will take up one or two positions (channels) on the list of devices, a special message will inform you about it. Press the key 1 (the device will occupy 1 position) or the key 2 (the device will occupy 2 positions).
8. Use the **▼** and **▲** keys to select the zone to which you want to assign the device.
9. Press **#**.
10. A message will be displayed to inform you that expander identification procedure has been started.
11. When the procedure is finished, the new name of the zone / output to which the device has been assigned will be displayed. You can change that name.
12. Press **#**.
13. If the device occupies two or more zones / outputs, the name giving procedure is repeated for them.

### 7.1.1.2 Removing wireless devices

#### DLOADX program

You can remove a wireless device in the “Structure” window, “Hardware” tab, after clicking the name of the controller on the device list, and then on the “Zones/Outputs” tab.

1. Click the “Read” button. The data related to wireless devices will be read from the controller (these data are not read after clicking the  button in the main menu).
2. Click the device you want to remove (if the device occupies two or more positions on the list, you can click any of them).
3. Click the “Remove device” button.
4. The “Confirm” window will open.
5. Click the “Yes” button.
6. The “Confirm” window will close.
7. Click the “identification” button. The wireless zones / outputs will not be removed from the alarm system until the expander identification procedure is finished.

#### LCD keypad

You can remove a wireless device in the service mode, using the “Remove device” function (►“Structure” ►“Hardware” ►“Expanders” ►“Settings” ►[*controller name*] ►“Remove device”).

1. Start the “Remove device” function.
2. List of wireless zones will be displayed.

3. Use the ▼ and ▲ keys to select the zone to which the device you want to remove is assigned.
4. Press #.
5. A prompt will be displayed asking you whether to remove the device (type and serial number of the device will be displayed).
6. Press the key 1.
7. A message will be displayed to inform you that the expander identification procedure has started.
8. When the procedure is finished, the list of wireless zones will be displayed again.

### 7.1.2 Expander for the PERFECTA 64 M control panel

To add or delete devices, you can use the PERFECTA Soft program (version required: 2.00 or newer). For description of the PERFECTA Soft program, refer to the control panel programming manual.

You can register in the controller:

- up to 4 PRF-LCD-A2 wireless keypads,
- up to do 48 detectors, sirens or other wireless devices.

Each position on the device list represents one wireless zone or one wireless zone and one output.

When adding and removing the wireless devices, remember that the identification function registers zones and outputs by groups of 8. Already after adding one wireless device which takes up 1 zone, the control panel will reserve 8 zones in the system for wireless devices. Observe continuity, i.e. avoid leaving any gaps in the list, which will later reduce the number of available zones in the system. Remember to preserve continuity also when removing wireless devices. For example, if the devices registered in the controller occupy 9 positions on the list, then 16 zones (2x8) are reserved in the system. After removal of the device which occupied position 7 on the list, there will still be 16 zones (2x8) reserved in the system for wireless devices, although 8 positions are actually taken up on the list of wireless devices (see: Table 6). In such a case, it is recommended that the last devices be removed from the list and then added to the system again, so as to fill up the gap in the list and reduce the number of zones reserved for wireless devices.

In case of devices which, in addition to zones, also take up outputs, it is recommended that you add them to the system first. This will allow you to maintain the continuity of use of not the zones alone, but the outputs as well.

In some cases, the gaps in the list of zones/outputs cannot be avoided. It applies to situation when the number of zones/outputs, which is used by the devices, is not a multiple of 8.

For each group of 8 zones/outputs, one address on the expander bus is reserved. The controller can occupy from 1 to 6 addresses (addresses from 8 (8h) to 13 (0Dh)). Remember about this at the system design stage. Leave a sufficient number of free addresses for the controller. Otherwise, it will be impossible to successfully identify devices. This will happen when the next addresses needed by the controller after new wireless devices have been added to the system are occupied by zone expanders. Then, it will be necessary to change addresses of the zone expanders.

Table 6 shows the example of wireless devices registered incorrectly. The first siren output occupies position 8, and the second output occupies position 9. As a result, 16 outputs have been reserved for wireless devices in the system, although actually only 2 are used (the eighth output in the first group of 8 outputs and the first output in the second group of 8 outputs). For devices taking up 8 positions, the system must reserve 16 zones and 16 outputs as well as 2 addresses. Table 7 shows the same devices registered correctly. For 8 devices, the system has reserved 8 zones and 8 outputs as well as 1 address.

ACU-220		PERFECTA 64 M				
It.	list of devices	zones		outputs		
		No	device	No	device	
1	APD-200 detector	8	9	APD-200 detector	5	unused/unavailable
2	APD-200 detector		10	APD-200 detector	6	unused/unavailable
3	AMD-200 detector		11	AMD-200 detector	7	unused/unavailable
4	AMD-200 detector		12	AMD-200 detector	8	unused/unavailable
5	AMD-201 detector		13	AMD-201 detector	9	unused/unavailable
6	^		14	AMD-201 detector	10	unused/unavailable
7			15	unused/unavailable	11	unused/unavailable
8	ASP-200 siren		16	ASP-200 siren	12	ASP-200 siren
9	^	8	17	ASP-200 siren	17	ASP-200 siren
10			18	unused/unavailable	18	unused/unavailable
11			19	unused/unavailable	19	unused/unavailable
12			20	unused/unavailable	20	unused/unavailable
13			21	unused/unavailable	21	unused/unavailable
14			22	unused/unavailable	22	unused/unavailable
15			23	unused/unavailable	23	unused/unavailable
16			24	unused/unavailable	24	unused/unavailable



Table 6. Example of ABAX 2 devices registered incorrectly.

ACU-220		PERFECTA 64 M				
It.	list of devices	zones		outputs		
		No	device	No	device	
1	ASP-200 siren	8	9	ASP-200 siren	5	ASP-200 siren
2	^		10	ASP-200 siren	6	ASP-200 siren
3	APD-200 detector		11	APD-200 detector	7	unused/unavailable
4	APD-200 detector		12	APD-200 detector	8	unused/unavailable
5	AMD-200 detector		13	AMD-200 detector	9	unused/unavailable
6	AMD-200 detector		14	AMD-200 detector	10	unused/unavailable
7	AMD-201 detector		15	AMD-201 detector	11	unused/unavailable
8	^		16	AMD-201 detector	12	unused/unavailable

Table 7. Example of ABAX 2 devices registered correctly.

**7.1.2.1 Adding new wireless devices**

**Adding a wireless keypad**

1. Click the “Hardware” tab.
2. Click one of the unused keypads. Address of this keypad will be assigned to the wireless keypad after the adding procedure is finished.
3. Click . The wireless device adding panel will be displayed.
4. In the “Serial no.” field, enter the serial number of the keypad.
5. Press any key on the keypad being added.
6. When the “Device’s data read” message will be displayed, click “OK”. The wireless device adding panel will close.
7. Click  to save changes.





## Adding other wireless device

You can assign detectors, sirens and other wireless devices to zones 9-56. When adding a device, you will select the number of zone to which the device will be assigned. If the device occupies more than one position on the list of devices, i.e. more than one zone, additional zones will be assigned automatically (these will be zones following the selected one).

If the device is also to be assigned to an output, the output number will be assigned automatically. For zones 9-16, the output numbers are 5-12 (see: Table 8). For zones 17-56, the output number is the same as the number of the selected zone.

ABAX 2 wireless zone	ABAX 2 wireless output
9	5
10	6
11	7
12	8
13	9
14	10
15	11
16	12



Table 8. Output numbers given to ABAX 2 devices assigned to zones 9-16.

1. Click the “Hardware” tab.
2. Click the ABAX 2 controller name.
3. Click the “Read” button to read data of wireless devices from the controller (controller data will not be read when you click  on the menu bar).
4. Click . The wireless device adding panel will be displayed.
5. In the “Serial no.” field, enter the serial number of the device.
6. Power on the device (install the battery in the device, turn on the device power, etc.).
7. A message will confirm that the device has been added (unless you have entered an invalid serial number, of which the message will inform you).
  - 7.1. Device type will be displayed.
  - 7.2. A new name of the zone to which the device is to be assigned will be displayed. You can change the name. If the device occupies two or more positions on the device list, the same name will be given to the other zones.
  - 7.3. If you want to change the number of the zone to which the device is to be assigned, click  in the “Zone No” field and select a number from the list.
  - 7.4. For some devices you can select if the device is to occupy one or two positions on the list of devices.
8. Click the “OK” button. The wireless device adding panel will close.
9. Click the “Write” button to save changes to the controller (changes will not be saved to the controller when you click  on the menu bar).
10. Click  to save changes to the control panel (zone / output name).
11. Start the device identification function (see the control panel installer manual).





### 7.1.2.2 Removing wireless devices

#### Removing a wireless keypad

1. Click the “Hardware” tab.
2. Click the wireless keypad you want to remove.
3. Click . The “Device deleting” window will be displayed.
4. Click “Delete”. The „Device deleting” window will close.
5. Click  to save changes to the control panel.

#### Removing other wireless device

1. Click the “Hardware” tab.
2. Click the ABAX 2 controller name.
3. Click the “Read” button to read data of wireless devices from the controller (controller data will not be read when you click  on the menu bar).
4. Click the device you want to remove.
5. Click . The “Device deleting” window will be displayed.
6. Click “Delete”. The „Device deleting” window will close.
7. Click the “Write” button to save changes to the controller (changes will not be saved to the controller when you click  on the menu bar).
8. Start the device identification function (see the control panel installer manual).

### 7.1.3 Expander for VERSA series control panels



*Most of the ABAX 2 wireless devices are identified in the alarm system by the names known from the ABAX system.*

*For information about registering the VERSA-KWRL2 keypad, consult the keypad manual.*

To add or delete devices, you can use the DLOADX program (version required: 1.21.000 or newer) or LCD keypad. For description of the DLOADX program and LCD keypads, refer to the control panel manuals.

You can register up to 30 devices to the controller. Each position on the device list represents one wireless zone or one wireless zone and one output.

#### 7.1.3.1 Adding new wireless devices

When adding devices you can select the alarm system zone to which you want to assign a device. It can be any zone to which no wireless device is still assigned. If the device takes up more than one position on the list of devices, additional zones will be assigned to the device automatically (these will be zones immediately following the selected one).

If the device is to be also assigned to an output, the output number will be the same as that of the selected zone.



*The control panel does not support wireless outputs with numbers from 13 to 30. Therefore it is not recommended that you assign any devices that are at the same time assigned to outputs (e.g. sirens, controllers, etc.) to the zones from 13 to 30.*

## DLOADX program

You can add a wireless device in the “VERSA – Structure” window, “Hardware” tab, after clicking the name of the controller on the device list, and then on the “Zones/Outputs” tab.

1. Click the “Read” button. The data related to wireless devices will be read from the controller (these data are not read after clicking the  button in the main menu).
2. Click the zone to which a new wireless device is to be assigned (you can also select the zone later in the “New wireless dev.” window).
3. Click the “New device” button.
4. The “New wireless dev.” window will open.
5. Enter the serial number of the device being added in the “Serial number” field.
6. Power on the device (install the battery in the device, turn on the device power, etc.).
7. A message will confirm that the device has been added (unless you have entered an invalid serial number, of which the message will inform you).
- 7.5. Device type will be displayed. For the AXD-200 multipurpose detector, you can select the device type.



*If the device type you select is different from the type set before the AXD-200 detector was added to the system, the type will change during the periodical communication. It results in a delay whose duration depends on the frequency of periodical communication (with the “ECO” option enabled, delay can be up to 3 minutes).*

- 7.6. A new name of the zone to which the device is to be assigned will be displayed. You can change the name. If the device occupies two or more positions on the device list, the same name will be given to the other zones. If the device is to be assigned to outputs, the outputs will be given the same name.
- 7.7. In the “Zone” field, select the number of the zone to which you want to assign the device (if you have not done this before or if you want to change the previously selected number).
- 7.8. For some devices you can select if the device is to occupy one or two positions on the list of devices.
8. Click the “OK” button.
9. The “New wireless dev.” window will close.
10. The new device will be displayed on the list of devices.
11. Click the “Write” button to save changes to the controller (these data will not be saved after clicking the  button in the main menu).

## LCD keypad

You can add wireless devices in service mode, using the “New device” function (►“2.Hardware” ►“1.Kpds. & exps” ►“3.Wireless dev.” ►“1.New device”).



1. Start the “New device” function.
2. When the “Serial number” is displayed, enter the serial number of the device being added.
3. Press **#**.
4. When the “Open device tamper” command is displayed, power on the device (insert the battery into the device, turn on the device power, etc.).
5. Type and serial number of the device will be displayed (if nothing happens, you might have entered a wrong serial number – press **\*** to quit the function).

6. Depending on the device:
  - if the device takes up only 1 zone or you cannot select how many positions the device is to occupy on the device list – press the key 1.
  - if you can select whether the device will take up one or two positions (channels) on the list of devices, a special message will inform you about it – press the key 1 (the device will occupy 1 position) or the key 2 (the device will occupy 2 positions).
7. Use the ▼ and ▲ keys to select the zone to which you want to assign the device.
8. Press #.
9. The new name of the zone / output to which the device has been assigned will be displayed. You can change that name.
10. Press #.
11. If the device occupies two or more zones / outputs, the name giving procedure is repeated for them.
12. In the next steps, you can configure the device settings.

### 7.1.3.2 Removing wireless devices

#### DLOADX program

You can remove a wireless device in the “VERSA – Structure” window, “Hardware” tab, after clicking the name of the controller on the device list, and then on the “Zones/Outputs” tab.

1. Click the “Read” button. The data related to wireless devices will be read from the controller (these data are not read after clicking the  button in the main menu).
2. Click the device you want to remove (if the device occupies two or more positions on the list, you can click any of them).
3. Click the “Delete” button.
4. The “Confirm” window will open.
5. Click the “Yes” button.
6. The “Confirm” window will close.
7. Click the “Write” button to save changes to the controller (these data will not be saved after clicking the  button in the main menu).

#### LCD keypad

You can remove a wireless device in the service mode, using the “Remove device” function (►“2.Hardware” ►“1.Kpds. & exps.” ►“3.Wireless dev.” ►“3.Remove device”).

1. Start the “Remove device” function.
2. List of wireless zones will be displayed.
3. Use the ▼ and ▲ keys to select the zone to which the device you want to remove is assigned.
4. Press #.
5. A prompt will be displayed asking you whether to remove the device (type and serial number of the device will be displayed).
6. Press the key 1.



### 7.1.4 Universal module of wireless devices



To add and remove devices, you can use the ABAX 2 Soft program (see “ABAX 2 Soft program” p. 18).

You can register up to 48 devices in the controller.

### 7.1.4.1 Adding new wireless devices



You can add a wireless device in the “Devices” tab.

1. Click . Data on wireless devices will be read from the controller.
2. Click .
3. The “Adding devices” window will be displayed.
4. In the “Serial number” field, enter the serial number of the device to be added.
5. Power on the device (install the battery in the device, turn on the device power, etc.).
6. A message will confirm that the device has been added (unless you have entered an invalid serial number, of which the message will inform you).
  - 6.1. Device type will be displayed. For the AXD-200 multipurpose detector, you can select the device type.

**i** *If the device type you select is different from the type set before the AXD-200 detector was added to the system, the type will change during the periodical communication. It results in a delay whose duration depends on the frequency of periodical communication (with the “ECO” option enabled, delay can be up to 3 minutes).*
  - 6.2. The device name will be displayed. You can change that name. If the device occupies two or more positions on the device list, the name will be repeated in all positions.
  - 6.3. For some devices you can select if the device is to occupy one or two positions on the list of devices.
  - 6.4. You can select which position(s) the device is to occupy on the list of devices.
7. Click .
8. The “Adding devices” window will close.
9. The new device will be displayed on the list of devices.
10. Click . The new device data will be written to the controller.

### 7.1.4.2 Removing wireless devices

You can remove a wireless device in the “Devices” tab.

1. Click . Data on wireless devices will be read from the controller.
2. Click the device you want to remove (if the device occupies two or more positions on the list, you can click any of them).
3. Click .
4. The “Device deleting” window will open.
5. Click the “DELETE” button.
6. The “Device deleting” window will close.
7. Click . The device data will be deleted from the controller.

## 8 Programming the ABAX 2 system

### 8.1 Expander for the INTEGRA / VERSA series control panels

To configure the wireless system settings you can use the DLOADX program or LCD keypad. For description of the DLOADX program and LCD keypads, refer to the control panel manuals.

For the INTEGRA series control panel:

- DLOADX program: “Structure” window → “Hardware” tab → “Expansion modules” branch → [controller name] (Fig. 24).
- LCD keypad:
  - system settings: service mode ▶ “Structure” ▶ “Hardware” ▶ “Expanders” ▶ “Settings” ▶ [controller name],
  - controller name: service mode ▶ “Structure” ▶ “Hardware” ▶ “Expanders” ▶ “Names” ▶ [controller name].

For the VERSA series control panel:

- DLOADX program: “VERSA – Structure” window → “Hardware” tab → “Expansion modules” branch → [controller name].
- LCD keypad:
  - controller settings: service mode ▶ “2.Hardware” ▶ “1.Kpds & exps.” ▶ “2.Settings” ▶ [controller name],
  - wireless devices settings: service mode ▶ “2.Hardware” ▶ “1.Kpds & exps.” ▶ “3.Wireless dev.”.

Names of parameters and options from the DLOADX program are used in this manual. Shown in square brackets at the description of a parameter or option is the name presented on the display of the INTEGRA alarm system keypad.

#### 8.1.1 Controller settings

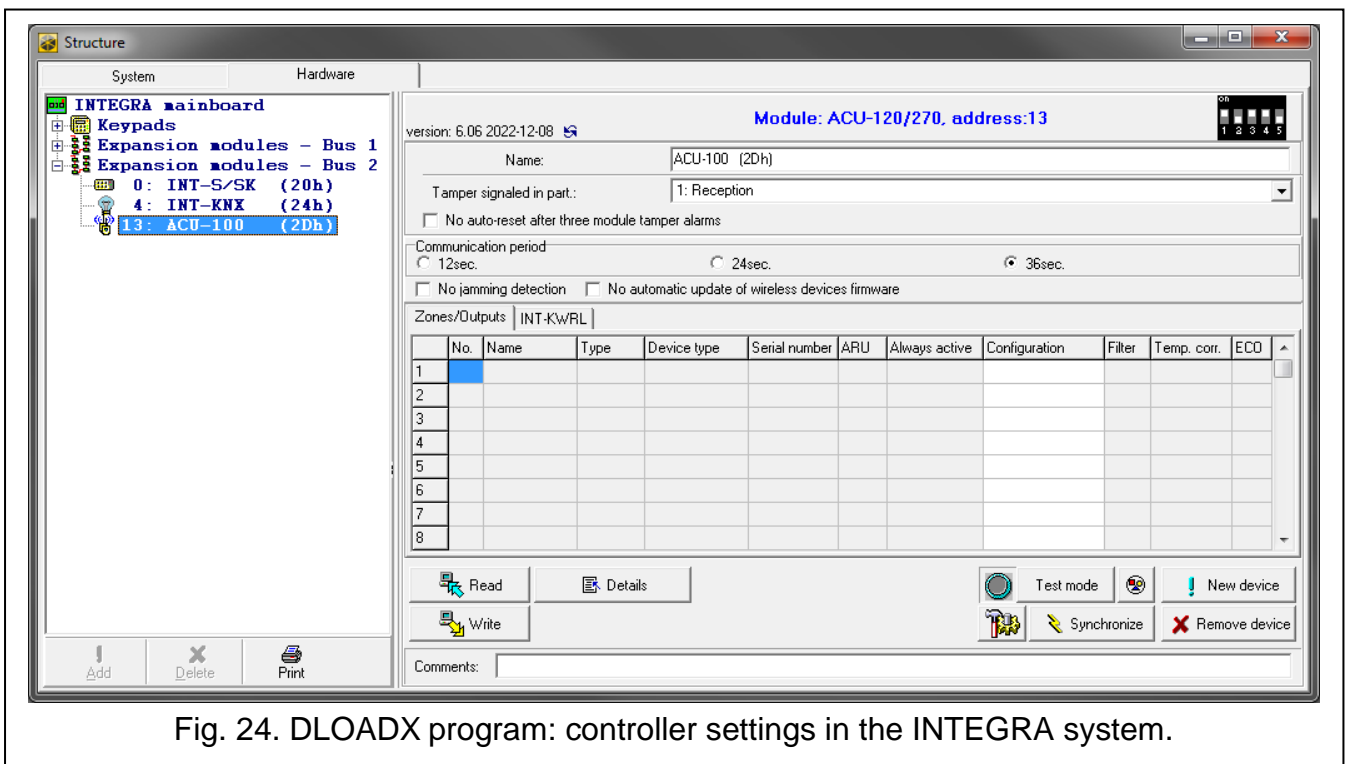

Fig. 24. DLOADX program: controller settings in the INTEGRA system.

**Name** – individual name of device (up to 16 characters).

**Tamper signaled in partition** [Tamper in part.] – partition where alarm will be generated in the event of module tamper.

**No auto-reset after three module tamper alarms** [No autorst.3t.] – if this option is enabled, each device tamper will generate alarm. If this option is disabled, any tamper following three uncleared alarms will no longer generate alarm (this is to prevent multiple logging of the same events).

**Communication period** [Response period] – define the time intervals at which wireless devices are to communicate with the controller. Periodical communication can take place every 12, 24 or 36 seconds. During periodical communication, the devices inform the controller about their status, and the controller sends commands to the devices (switches the detectors into active/passive mode, starts/ends test mode, changes configuration of the devices, etc.). The communication period has effect on the level of energy consumption by wireless devices: the less frequent is the communication, the lower is the energy consumption. For the battery-operated devices it means longer battery life. Moreover, when the communication takes place less frequently, more wireless devices can work within each other's operating range.

**i** *If you enable the “ECO” option for a wireless device, periodical communication between that device and the controller will take place every 3 minutes (the “Communication period” parameter will have no effect on the device operation).*

*Some information and commands need to be sent immediately. Therefore, additional communication takes place when the device reports tamper, when the detector reports alarm, etc.*

**No jamming detection** [No jam detect.] – if this option is enabled, the controller will not detect radio communication jamming. This option is available for the controller in the INTEGRA system.

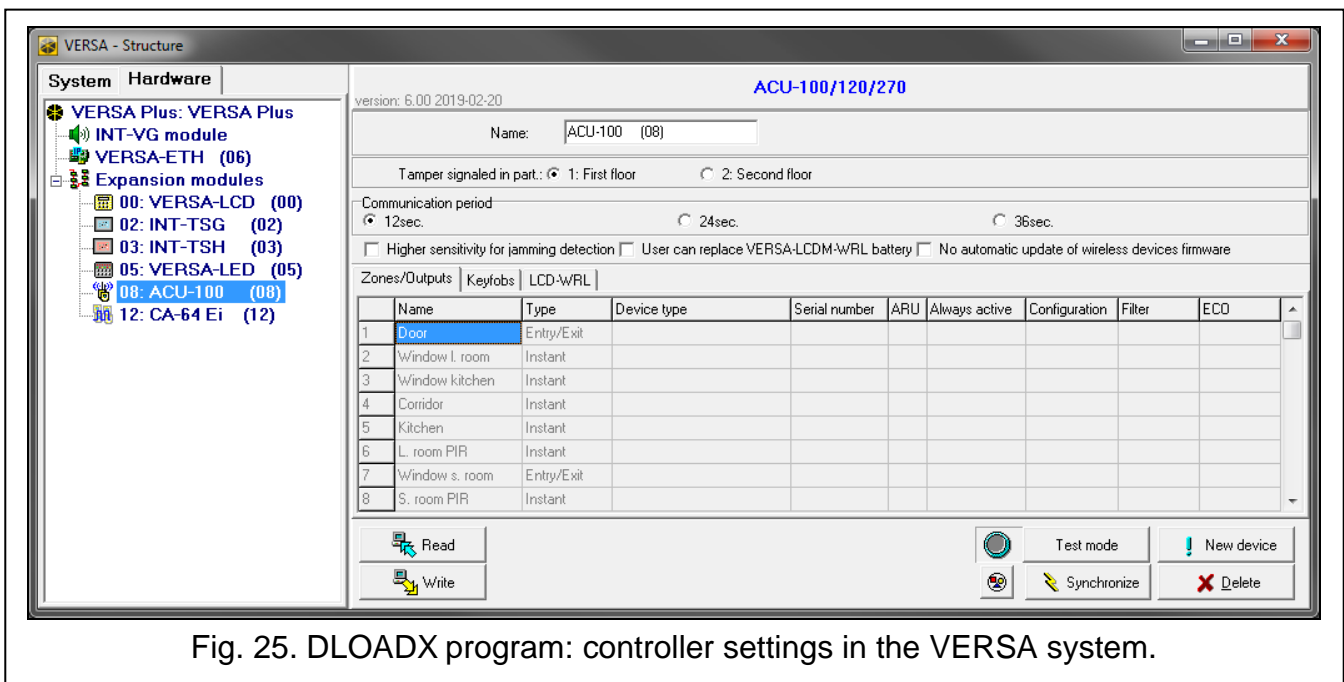



Fig. 25. DLOADX program: controller settings in the VERSA system.

**No automatic update of wireless devices firmware** [No updates] – if this option is enabled, the firmware of wireless devices registered in the controller is not updated automatically (see “Updating the firmware of ABAX 2 wireless devices” p. 78).

**User can replace VERSA-LCDM-WRL battery** – if this option is enabled, all users can replace battery in the VERSA-KWRL2 wireless keypads (for 3 minutes after the code is

entered and confirmed with the  key, the status of tamper switch will not be monitored on the keypad that was used to enter the code). If the option is disabled, the battery can only be replaced by the users who have access to the “Replace bat.” function in the “0.Service” submenu.

### 8.1.2 Functions

**Test mode** – to carry out diagnostics / service work, you can start the test mode in the ABAX 2 system. When the system is running in the test mode:

- detector LEDs are enabled,
- tamper signaling in the sirens is blocked.

The command to start/end the test mode is sent during periodical communication, i.e. with delay whose duration depends on the frequency of periodical communication. The test mode will be disabled automatically 30 minutes after:

- starting the test mode from the DLOADX program (the countdown of 30 minutes runs from exiting the controller settings),
- exiting the service mode in the INTEGRA / VERSA control panel,
- closing the ABAX 2 Soft program.



*As required by EN 50131, the level of radio signal sent by wireless devices is lowered when the system is running in the test mode.*

**Synchronize** – the function does not apply to the ABAX 2 system.

### 8.1.3 Device settings

**ARU** [Use ARU-100] – parameter available for a wireless device, if the ARU-200 repeater is registered in the controller (controller in the INTEGRA system). It allows you to define whether the device is to communicate to the controller directly, or via the selected ARU-200 repeater (several ARU-200 repeaters can be registered in the controller).

**Always active** [Active mode] – the option is available for the most of wireless detectors. If enabled, the detector is permanently switched over to the active mode (see „Wireless detectors” p. 55).



*The wireless detectors assigned to 24-h zones are always in the active mode, therefore the “Always active” option does not have to be enabled for them.*

*The battery life time in the detectors switched permanently into the active mode is shorter than in those which are periodically switched to the passive mode.*

**Configuration** [Settings] – for some devices you can configure additional settings. Shown in parentheses is the device name in the ABAX 2 system (if the device is identified in the alarm system by the name known from the ABAX system). Shown in square brackets is information about the number of zone for which additional parameters are to be programmed if the device takes up more than one zone.

**ACD-220** – wireless curtain detector. You can configure the sensitivity.

**ADD-200** – wireless outdoor dusk and temperature detector. You can configure:

- sensitivity of the dusk sensor (detection threshold) [first zone],
- temperature parameters [second zone]:
  - threshold type: high (when the temperature rises above the defined value, alarm will be generated) or low (when the temperature drops below the defined value, alarm will be generated),
  - temperature,
  - tolerance.

**AGD-100 (AGD-200)** – wireless glass-break detector. You can configure sensitivity.

**AMD-100 (AMD-200) / AMD-101 (AMD-201)** – wireless magnetic contact. Do not configure the detector settings (the AMD-200 / AMD-201 detector does not have two reed switches).

**AMD-102 (AMD-202)** – wireless magnetic contact with input for roller shutter detector:

- do not configure the magnetic contact settings [first zone] (the AMD-202 detector does not have two reed switches).
- you can configure parameters of roller shutter input [second zone]:
  - number of pulses after which the roller shutter input will generate alarm,
  - time period during which the defined number of pulses must occur for the roller shutter input to generate alarm.

**AOCD-250 (AOCD-260)** – wireless outdoor dual technology curtain detector. You can configure:

- sensitivity of the PIR sensor,
- sensitivity of the microwave sensor.

**AOD-200 (AOD-210)** – wireless outdoor dual technology motion detector. You can configure:

- sensitivity of the PIR sensor,
- sensitivity of the microwave sensor,
- sensitivity of the dusk sensor (detection threshold).

**APD-100 (APD-200)** – wireless passive infrared detector. You can configure sensitivity.

**APD-100 (APD-200 Pet)** – wireless passive infrared detector with pet immunity up to 20 kg:

- you can configure sensitivity,
- do not configure the pet immunity option (the APD-200 Pet detector is always immune to the movement of pets).

**APMD-150 (APMD-250)** – wireless dual technology detector. You can configure:

- sensitivity of the PIR sensor,
- sensitivity of the microwave sensor,
- manner of operation in the test mode.

**ARD-100 (ARD-200)** – wireless reorientation detector. You can configure sensitivity.

**ART-200** – wireless radiator thermostat. You can:

- select the sensor that will provide data on temperature,
- select the alarm system “120. Thermostat” type output, whose settings will be used by the thermostat,
- select the alarm system output that will be used to disable the capability to switch between the thermostat operating modes remotely. Turn on the output to enable the “Manual setting of the valve position / temperature” operating mode.

**ASD-150 (ASD-250)** – wireless smoke detector. You can configure:

- option to indicate alarm from other ASD-250 detectors,
- option to send alarm to other ASD-250 detectors.

**ATD-100 (ATD-200)** – wireless temperature detector. You can configure the temperature threshold parameters for both positions occupied by the detector (which enables two different temperature thresholds to be programmed):

- threshold type: high (when the temperature rises above the defined temperature, alarm will be generated) or low (when the temperature drops below the defined temperature, alarm will be generated),
- temperature,
- tolerance.



**ATX-230** – hardwired zone expander: NC and roller shutter. You can configure parameters of roller shutter input [second zone]:

- number of pulses after which the roller shutter input will generate alarm,
- time period during which the defined number of pulses must occur for the roller shutter input to generate alarm.

**AVD-100 (AVD-200)** – wireless shock detector and magnetic contact:

- do not configure the magnetic contact settings [first zone] (the AVD-200 detector does not have two reed switches).
- for the shock detector [second zone]:
  - you can configure sensitivity (registering a shock meeting the sensitivity criterion will generate alarm),
  - do not configure the number of shocks (the AVD-200 detector does not count up the shocks).

**ASP-100 (ASP-200)** – wireless outdoor siren. You can configure:

- type of acoustic signaling,
- maximum duration of signaling.

**ASP-205 (ASP-215)** – wireless indoor siren. You can configure the signaling parameters for both positions occupied by the siren (which enables two different types of signaling to be programmed):

- maximum duration of signaling,
- type of acoustic signaling,
- optical signaling option.

**ASW-100 (ASW-200)** – 230 VAC smart plug. You can select operating mode.

**ASW-210** – flush-mounted wireless two-channel 230 VAC controller. You can select the operating mode of the controller inputs.

**Filter** [Filter] – the number of consecutive communication periods without connection between the device and the controller after which loss of communication with the device will be reported. You can enter values from 0 to 50. Entering 0 disables the check for device presence in the system.

**Temp. corr.** – you can correct the temperature information sent by the device by up to  $\pm 3.5^{\circ}\text{C}$ .

**ECO** – if this option is enabled, periodical communication with the device takes place every 3 minutes. Thus the battery life can be extended up to four times.



*Remember that with the “ECO” option enabled for:*

*detectors – delay between arming / disarming and changing the detector operating mode (active / passive) can be up to three minutes,*

*ASP-215 siren – delay in starting / stopping the signaling can be up to three minutes.*

### **8.1.3.1 Programming devices using the DLOADX program**

Before making any changes, click the “Read” button, and after making the changes – the “Write” button. The data on wireless devices are not read / written when you use buttons in the DLOADX main menu.

#### **ARU**

In the “ARU” column:

- leave the field blank, if the device is to communicate directly to the controller,

- enter the ARU-200 repeater number in the list of wireless devices, if the device is to communicate to the controller via the repeater (the repeater takes up two positions on the list of devices – enter the number of the first of them).

## **Configuration**

In the “Configuration” column you can configure additional settings for the ABAX 2 devices.

### ***ACD-220***

Enter a digit from the 1 to 3 range to set the sensitivity (1 – low, 2 – medium, 3 – high).

### ***ADD-200***

Dusk sensor – enter a number from the 1 to 16 range to determine sensitivity (1 – minimum; 16 – maximum).

Temperature sensor – enter in turn:

- letter H (high temperature threshold) or L (low temperature threshold),
- number from a range of -30 to +70 (with 0.5 accuracy) to define temperature,
- number from a range of 0.5 to 10 (with 0.5 accuracy) to define tolerance.

### ***AGD-100 (AGD-200)***

Enter a digit from the 1 to 3 range to set the sensitivity (1 – low, 2 – medium, 3 – high).

### ***AMD-100 (AMD-200) / AMD-101 (AMD-201)***

Do not configure.

### ***AMD-102 (AMD-202)***

Magnetic contact – do not configure.

Roller shutter input – enter 2 digits:

1st digit – number of pulses: from 1 to 8.

2nd digit – counting time: 0 (30 seconds), 1 (120 seconds), 2 (240 seconds) or 3 (unlimited time).

### ***AOCD-250 (AOCD-260)***

Enter 2 digits:

1st digit – sensitivity of PIR sensor: from 1 to 4 (1 – minimum; 4 – maximum).

2nd digit – sensitivity of microwave sensor: from 1 to 8 (1 – minimum; 8 – maximum).

### ***AOD-200 (AOD-210)***

Enter 3 digits:

1st digit – sensitivity of PIR sensor: from 1 to 4 (1 – minimum; 4 – maximum).

2nd digit – sensitivity of microwave sensor: from 1 to 8 (1 – minimum; 8 – maximum).

3rd digit – sensitivity of dusk sensor: from 1 to 4 (1 – minimum; 4 – maximum).

### ***APD-100 (APD-200)***

Enter a digit from the 1 to 3 range to set the sensitivity (1 – low, 2 – medium, 3 – high).

### ***APD-100 (APD-200 Pet)***

Enter 2 digits:

1st digit – sensitivity: 1 (low), 2 (medium) or 3 (high),

2nd digit – pet immunity option – 0 or 1 (the entered value is irrelevant).

**APMD-150 (APMD-250)**

Enter 3 digits:

1st digit – sensitivity of PIR sensor: from 1 to 4 (1 – minimum; 4 – maximum).

2nd digit – sensitivity of microwave sensor: from 1 to 8 (1 – minimum; 8 – maximum).

3rd digit – the way of operation in the test mode: 0 (alarm after motion is detected by both sensors), 1 (alarm after motion is detected by PIR sensor) or 2 (alarm after motion is detected by microwave sensor).

**ARD-100 (ARD-200)**

Enter a number from the 1 to 16 range to determine sensitivity (1 – minimum; 16 - maximum).

**ART-200**

Click  to open the radiator thermostat settings window.

Fig. 26. DLOADX program: window with the ART-200 radiator thermostat settings.

**Temperature meas. source** – select the sensor that will provide data on temperature:

**Internal** – thermostat sensor,

**[Device name]** – temperature sensor of an ABAX 2 system device.

**Thermostat output** – select the alarm system “120. Thermostat” type output, whose settings will be used by the thermostat.

**Temperature T1/T2** – information on temperature thresholds defined for the selected “120. Thermostat” type output (T1 – economic temperature / T2 – comfortable temperature).

**Switch-off output** – select the alarm system output that will be used to disable the capability to switch between the thermostat operating modes remotely. Turn on the output to enable the “Manual setting of the valve position / temperature” operating mode.

**ASD-150 (ASD-250)**

Enter 2 digits:

1st digit – option to signal alarm from other ASD-250 detectors: 0 (disabled) or 1 (enabled).

2nd digit – option to send out alarm to other ASD-250 detectors: 0 (disabled) or 1 (enabled).

**ATD-100 (ATD-200)**

For each position taken by the detector, enter in turn:

- letter H (high temperature threshold) or L (low temperature threshold),
- number from a range of -30 to +70 (with 0.5 accuracy) to define temperature,
- number from a range of 0.5 to 10 (with 0.5 accuracy) to define tolerance.

**ATX-230**

Roller shutter input – enter 2 digits:

1st digit – number of pulses: from 1 to 8.

2nd digit – counting time: 0 (30 seconds), 1 (120 seconds), 2 (240 seconds) or 3 (unlimited time).

**AVD-100 (AVD-200)**

Magnetic contact – do not configure.

Shock detector – enter 2 digits:

1st digit – sensitivity: from 1 to 8 (1 – minimum ; 8 – maximum).

2nd digit – the number of shocks – the entered value is irrelevant.

**ASP-100 (ASP-200)**

Enter 2 digits:

1st digit – type of acoustic signaling: from 1 to 4 – see table 9.

2nd digit – maximum duration of signaling: 1 (1 minute), 2 (3 minutes), 3 (6 minutes) or 4 (9 minutes).





<b>1</b>	Two sound frequencies (1450 Hz/2000 Hz) alternating within 1 second.	
<b>2</b>	Sound with rising frequency (from 1450 Hz to 2000 Hz) within 1 second.	
<b>3</b>	Sound with smoothly rising and falling frequency (1450 Hz – 2000 Hz – 1450 Hz) within 1 second.	
<b>4</b>	Sound with falling frequency (from 2000 Hz to 1450 Hz) within 1 second.	

Table 9. Types of acoustic signaling available in the ASP-200 siren.

**ASP-205 (ASP-215)**

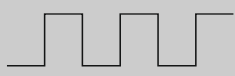
For each position taken on the list by the siren, enter 3 digits:

1st digit – maximum duration of signaling: 1 (1 minute), 2 (3 minutes), 3 (6 minutes) or 4 (9 minutes).

2nd digit – type of acoustic signaling: 0 (disabled), 1 (sound type 1), 2 (sound type 2) or 3 (sound type 3) – see table 10.

3rd digit – optical signaling: 0 (disabled) or 1 (enabled).



<b>1</b>	Two sound frequencies (1450 Hz/2000 Hz) alternating within 1 second.	
<b>2</b>	Sound with rising frequency (from 1450 Hz to 2000 Hz) within 1 second.	
<b>3</b>	Sound with falling frequency (from 2000 Hz to 1450 Hz) within 1 second.	

Table 10. Types of acoustic signaling available in the ASP-215 siren.

**ASW-100 (ASW-200)**

Enter 0 (only remote control), 1 (remote or manual control) or 2 (remote or manual control, but with option to manually block the remote control).

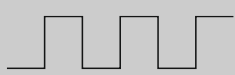
**ASW-210**

For each position occupied by the controller, enter 0 (relay can only be controlled via the control panel), 1 (the input enables relay to be controlled with monostable switch) or 2 (the input enables relay to be controlled with bistable switch).

### 8.1.3.2 Programming devices using the LCD keypad

#### INTEGRA

To configure devices, use the functions: “Use ARU-100”, “Active mode”, “Settings”, “Filter” and “ECO” (service mode ► “Structure” ► “Hardware” ► “Expanders” ► “Settings” ► [controller name]). Having started the function, use the ▼ and ▲ keys to select the zone to which the wireless device is assigned and press #.

#### Use ARU-100

Using the ▼ and ▲ keys select whether the wireless device is to communicate to the controller directly, or via a selected repeater (the names of the zones to which the repeaters are assigned are displayed on the list).

#### Active mode

Press any key to define whether the detector is to be always active (· – no,  – yes).

#### Settings

To configure parameters and options, use the arrow keys and the number keys. For description of the settings, see the section on programming devices from the DLOADX program.

#### Filter

Using the number keys, enter a number from a range of 0 to 50 to define the rules of device presence control.

#### VERSA

You can configure the device settings:

- immediately after registering the device to the controller,
- using the “Config.device” function (service mode ► “2.Hardware” ► “1.Kpds. & exps” ► “3.Wireless dev.” ► “2.Config.device”). Having started the function, use the ▼ and ▲ keys to select the zone to which the device is assigned and press #.

The programming is performed using the “step by step” method. Described below is how to configure the devices for which additional settings are available.

#### AGD-100 (AGD-200)

1. Enter a number from the 0 to 50 range to define the rules of device presence control.
2. Press #.
3. Define whether the detector is to be always active by pressing any number key (· – no,  – yes).
4. Press #.
5. Enter a digit from the 1 to 3 range to define sensitivity (1 – low, 2 – medium, 3 – high).
6. Press #.

#### AMD-100 (AMD-200) / AMD-101 (AMD-201)

1. Enter a number from the 0 to 50 range to define the rules of device presence control.
2. Press #.
3. Define whether the detector is to be always active by pressing any number key (· – no,  – yes).
4. Press #.
5. When the reed switch settings are displayed, press # (these settings are irrelevant).

**AMD-102 (AMD-202)**

For the magnetic contact:

1. Enter a number from the 0 to 50 range to define the rules of device presence control.
2. Press **#**.
3. Define whether the detector is to be always active by pressing any number key (· – no,  – yes).
4. Press **#**.
5. When the reed switch settings are displayed, press **#** (these settings are irrelevant).

For the roller shutter input:

1. Enter a digit from the 1 to 8 range to define the number of pulses that will generate alarm.
2. Press **#**.
3. Use the **▼** and **▲** keys to select the pulse validity (30, 120 or 240 seconds or unlimited duration).
4. Press **#**.

**AOCD-250 (AOCD-260)**

1. Enter a number from the 0 to 50 range to define the rules of device presence control.
2. Press **#**.
3. Define whether the detector is to be always active by pressing any number key (· – no,  – yes).
4. Press **#**.
5. Enter a digit from the 1 to 4 range to define sensitivity of the PIR sensor (1 – minimum; 4 – maximum).
6. Press **#**.
7. Enter a digit from the 1 to 8 range to define sensitivity of the microwave sensor (1 - minimum; 8 – maximum).
8. Press **#**.

**AOD-200 (AOD-210)**

1. Enter a number from the 0 to 50 range to define the rules of device presence control.
2. Press **#**.
3. Define whether the detector is to be always active by pressing any number key (· – no,  – yes).
4. Press **#**.
5. Enter a digit from the 1 to 4 range to define sensitivity of the PIR sensor (1 – minimum; 4 – maximum).
6. Press **#**.
7. Enter a digit from the 1 to 8 range to define sensitivity of the microwave sensor (1 - minimum; 8 – maximum).
8. Press **#**.
9. Enter a digit from the 1 to 4 range to define sensitivity of the dusk sensor (1 – minimum; 4 – maximum).
10. Press **#**.

**APD-100 (APD-200)**

1. Enter a number from the 0 to 50 range to define the rules of device presence control.
2. Press **#**.

3. Define whether the detector is to be always active by pressing any number key (· – no,  – yes).
4. Press **#**.
5. Enter a digit from the 1 to 3 range to define sensitivity (1 – low, 2 – medium, 3 – high).
6. Press **#**.

#### **APD-100 (APD-200 Pet)**

1. Enter a number from the 0 to 50 range to define the rules of device presence control.
2. Press **#**.
3. Define whether the detector is to be always active by pressing any number key (· – no,  – yes).
4. Press **#**.
5. Enter a digit from the 1 to 3 range to define sensitivity (1 – low, 2 – medium, 3 – high).
6. Press **#**.
7. When the pet immunity settings are displayed, press **#** (these settings are irrelevant).

#### **APMD-150 (APMD-250)**

1. Enter a number from the 0 to 50 range to define the rules of device presence control.
2. Press **#**.
3. Define whether the detector is to be always active by pressing any number key (· – no,  – yes).
4. Press **#**.
5. Enter a digit from the 1 to 4 range to define sensitivity of the PIR sensor (1 – minimum; 4 – maximum).
6. Press **#**.
7. Enter a digit from the 1 to 8 range to define sensitivity of the microwave sensor (1 - minimum; 8 – maximum).
8. Press **#**.
9. Use the ▼ and ▲ keys to select how the detector will work in the test mode (PIR+MW, PIR or MW).
10. Press **#**.

#### **ARD-100 (ARD-200)**

1. Enter a number from the 0 to 50 range to define the rules of device presence control.
2. Press **#**.
3. Define whether the detector is to be always active by pressing any number key (· – no,  – yes).
4. Press **#**.
5. Enter a number from the 1 to 16 range to define sensitivity (1 – minimum; 16 – maximum).
6. Press **#**.

#### **ASD-150 (ASD-250)**

1. Enter a number from the 0 to 50 range to define the rules of device presence control.
2. Press **#**.
3. Press any numeric key to define whether the detector is to signal alarm from other ASD-250 detectors (· – no,  – yes).
4. Press ▼.

5. Press any numeric key to define whether the detector is to send out alarm to other ASD-250 detectors (· – no,  – yes).
6. Press **#**.

### **AVD-100 (AVD-200)**

For the magnetic contact:

1. Enter a number from the 0 to 50 range to define the rules of device presence control.
2. Press **#**.
3. Define whether the detector is to be always active by pressing any number key (· – no,  – yes).
4. Press **#**.
5. When the reed switch settings are displayed, press **#** (these settings are irrelevant).

For the shock detector:

1. Enter a digit from the 1 to 8 range to define sensitivity (1 – minimum; 8 – maximum).
2. Press **#**.
3. When the settings regarding the number of shocks are displayed, press **#** (these settings are irrelevant).

### **ASP-100 (ASP-200)**

1. Enter a number from the 0 to 50 range to define the rules of device presence control.
2. Press **#**.
3. Use the **▼** and **▲** keys to select the type of acoustic signaling (see table 9).
4. Press **#**.
5. Use the **▼** and **▲** keys to define the maximum duration of signaling.
6. Press **#**.

### **ASP-205 (ASP-215)**

You can program two different ways of signaling:

- having selected the first of the zones – signaling triggered by the first output controlling the siren,
- having selected the second of the zones – signaling triggered by the second output controlling the siren.

Configuration is similar for both zones, however, the step in which the rules of device presence control are defined is skipped for the second zone.

1. Enter a number from the 0 to 50 range to define the rules of device presence control.
2. Press **#**.
3. Use the **▼** and **▲** keys to define how the acoustic signaling will work (· – disabled; 1, 2 or 3 – type of acoustic signaling – see table 10).
4. Press **#**.
5. Use the **▼** and **▲** keys to define the maximum duration of signaling.
6. Press **#**.
7. Define whether the optical signaling is to be enabled (· – no,  – yes).
8. Press **#**.

### **ASW-100 (ASW-200)**

1. Enter a number from the 0 to 50 range to define the rules of device presence control.
2. Press **#**.



3. Use the ▼ and ▲ keys to define the way of control (“inactive” – only remote control; “interim control” – remote or manual control; “combined control” – remote or manual control, but with option to manually block the remote control).
4. Press #.

### 8.1.4 Specific character of the operation of wireless devices

When programming the alarm system zones and outputs to which the wireless devices are assigned, you must take into account the specific character of operation of individual devices.

#### 8.1.4.1 Wireless detectors

The zone to which a wireless detector is assigned is activated when the detector reports alarm (select the appropriate zone type). If a detector tamper is to generate the tamper alarm, program the zone as 2EOL/NC or 2EOL/NO.

Operation of the detector is affected by the state of partition to which the zone belongs:

**partition disarmed** – the detector operates in **passive mode**. This operating mode prolongs the battery life. Detector informs the controller about its status during periodical communication (only the tamper information is sent immediately).

**partition armed** – the detector operates in **active mode**. Detector informs the controller about alarm or tamper immediately.

Switching the detector from passive mode to active and vice versa takes place during periodical communication. It results in a delay whose duration depends on the frequency of periodical communication (with the “ECO” option enabled, delay can be up to 3 minutes).

Detectors assigned to the zones that are always armed are permanently in the active mode.

For most detectors, you can enable the “Always active” option.



*According to the EN 50131-3 standard all ABAX 2 system Hold-Up devices must be always in active mode.*

*The battery life time in the detectors switched permanently into the active mode is shorter than in those which are periodically switched to the passive mode. However, if the specific character of a detector or its installation place is such that the number of alarms is low, switching the detector permanently into the active mode will not have a significant effect on the battery life.*

#### 8.1.4.2 Wireless sirens

Turning on the output to which the wireless siren is assigned will trigger the signaling. Depending on the siren:

**ASP-200** – the first output controls the acoustic signaling, the second – the optical signaling. Thanks to a high-capacity battery, the siren can receive transmissions from the controller at any time. Therefore, the commands to start/stop signaling are sent to the siren immediately.

**ASP-215** – both outputs can control the acoustic and optical signaling. This enables two different, independently triggered types of signaling to be configured. The outputs can control separately the acoustic and optical signaling or trigger other signaling for different alarms (e.g. burglary and fire). Given its low-capacity battery, the siren can receive transmissions from the controller during periodical communication only. Therefore, the commands to start/stop signaling are sent to the siren during periodical communication. Consequently, the operating time of outputs controlling the siren should be longer than the communication period.

The signaling will stop after the maximum signaling time expires, even if the output is still active.

The zones to which the wireless siren is assigned are activated if the signaling is triggered (select the appropriate zone type). If the siren tamper is to generate tamper alarm, program the zone as 2EOL/NC or 2EOL/NO.

The tamper information is sent immediately, and the signaling state information – during periodical communication.

#### **8.1.4.3 Wireless expanders of hardwired zones and outputs**

You can configure the alarm system zone/output to which expander zone/output is assigned in much the same way as hardwired zones/outputs. You must, however, keep in mind that sensitivity of the expander zones may be different from that programmed in the control panel:

- from 20 ms to 140 ms – corresponds to sensitivity programmed in the control panel;
- above 140 ms – only some values are available: 400 ms, 500 ms, 700 ms, etc. every 200 ms (the programmed value is rounded up to that supported by the expander).



*The EN 50131-3 standard requires that zones must react to signals lasting more than 400 ms. Therefore, select 400 ms when programming sensitivity of the alarm zones.*

Information on the state of zones and commands to change the state of outputs are sent immediately. Zone settings are sent during periodical communication.



*If communication with the controller is lost, all previously activated outputs will be deactivated after 20 communication periods.*

If the ACX-220 expander is powered from a power supply connected to the APS connector, the low battery information provided by the control panel means:

first zone – power supply overload,

second zone – low battery,

third zone – AC mains loss.

#### **8.1.4.4 Smart plug / Wireless 230 VAC controller**

Turning on the output which the plug / controller is assigned to turns on the relay controlling the 230 VAC circuit (turns on the device connected to the plug / controller).

The zone which the plug / controller is assigned to is activated when:

- operating modes 1 and 2: the relay controlling the 230 VAC circuit is turned on,
- operating mode 0: plug button is pressed / controller input is activated.

Select the appropriate zone type.



*If the ASW-210 controller occupies one position on the list of wireless devices, only the first controller input (SW1) is supported and the state of both relays changes simultaneously.*

#### **8.1.4.5 Wireless radiator thermostat**

The thermostat operates as defined by the “120. Thermostat” type output settings. Select this output while programming the thermostat settings. When the thermostatic output’s first temperature threshold (temperature T1) is active, the thermostat operates in the “Economic temperature” mode. When the thermostatic output’s second temperature threshold (temperature T2) is active, the thermostat operates in the “Comfortable temperature” mode. You will find more information on the “120. Thermostat” type output settings in the control panel programming manual.

While programming the thermostat settings, you can select an output that will disable the capability to switch between operating modes as described above. If this output is turned on, the “Manual setting of the valve position / temperature” mode will be enabled. In this

operating mode the thermostat can only be controlled manually. If this output is turned off, the thermostat will operate as defined by the “120. Thermostat” type output settings.



*If the “Edition in ART-200” option is disabled in the “120. Thermostat” type output settings, you will not be able to control the thermostat manually (the thermostat keys will be disabled).*

The zone to which the thermostat is assigned is active when the radiator valve is open (set in position other than fully closed). When the zone is in normal state, the valve is fully closed (it is 0% open). If tamper alarm is to be generated whenever the anti-freeze protection is activated (when temperature drops below 5°C), program the zone as 2EOL/NC or 2EOL/NO. Information on the position of the valve and the anti-freeze protection being activated is sent during periodical communication.

Controlling the thermostat is impossible when the following errors occur: F01 – problem with changing the valve position, F02 – wrong calibration, F03 – low battery. The errors will be indicated as no communication with the thermostat.

#### **8.1.4.6 Radio signal repeater**

The first zone to which the radio signal repeater is assigned is activated in the event of 230 VAC mains loss (select the appropriate zone type).



The second zone to which the radio signal repeater is assigned is activated in the event of battery trouble (select the appropriate zone type).

If tamper of the radio signal repeater is to generate tamper alarm, program the zone as 2EOL/NC or 2EOL/NO.

## **8.2 Expander for the PERFECTA 64 M control panel**

---

To configure the ABAX 2 wireless system settings you can only use the PERFECTA Soft program. For description of the PERFECTA Soft program, refer to the control panel programming manual.

Before you make any changes, click the “Read” button, and after you make the changes, click the “Write” button. The controller and wireless devices settings are not read / written after clicking  /  on the menu bar.

### **8.2.1 Controller settings**

**Name** – individual name of the module (up to 16 characters).

**Alarm in part.** – partition where alarm will be generated in the event of module tamper.

**Communication period** – time interval at which wireless devices are to communicate with the controller. You can select 12, 24 or 36 seconds. During periodical communication, the devices inform the controller about their status, and the controller sends commands to the devices (switches the detectors into active/passive mode, starts/ends test mode, changes configuration of the devices, etc.). The communication period has effect on the level of energy consumption by wireless devices. The less frequent is the communication, the lower is the energy consumption. For the battery-operated devices it means longer battery life. Moreover, when the communication takes place less frequently, more wireless devices can work within each other's operating range.



*If you enable the “ECO” option for a wireless device, periodical communication between that device and the controller will take place every 3 minutes (the “Communication period” parameter will have no effect on the device operation).*

*Some information and commands need to be sent immediately. Therefore, additional communication takes place when the device reports tamper, when the detector reports alarm, etc.*

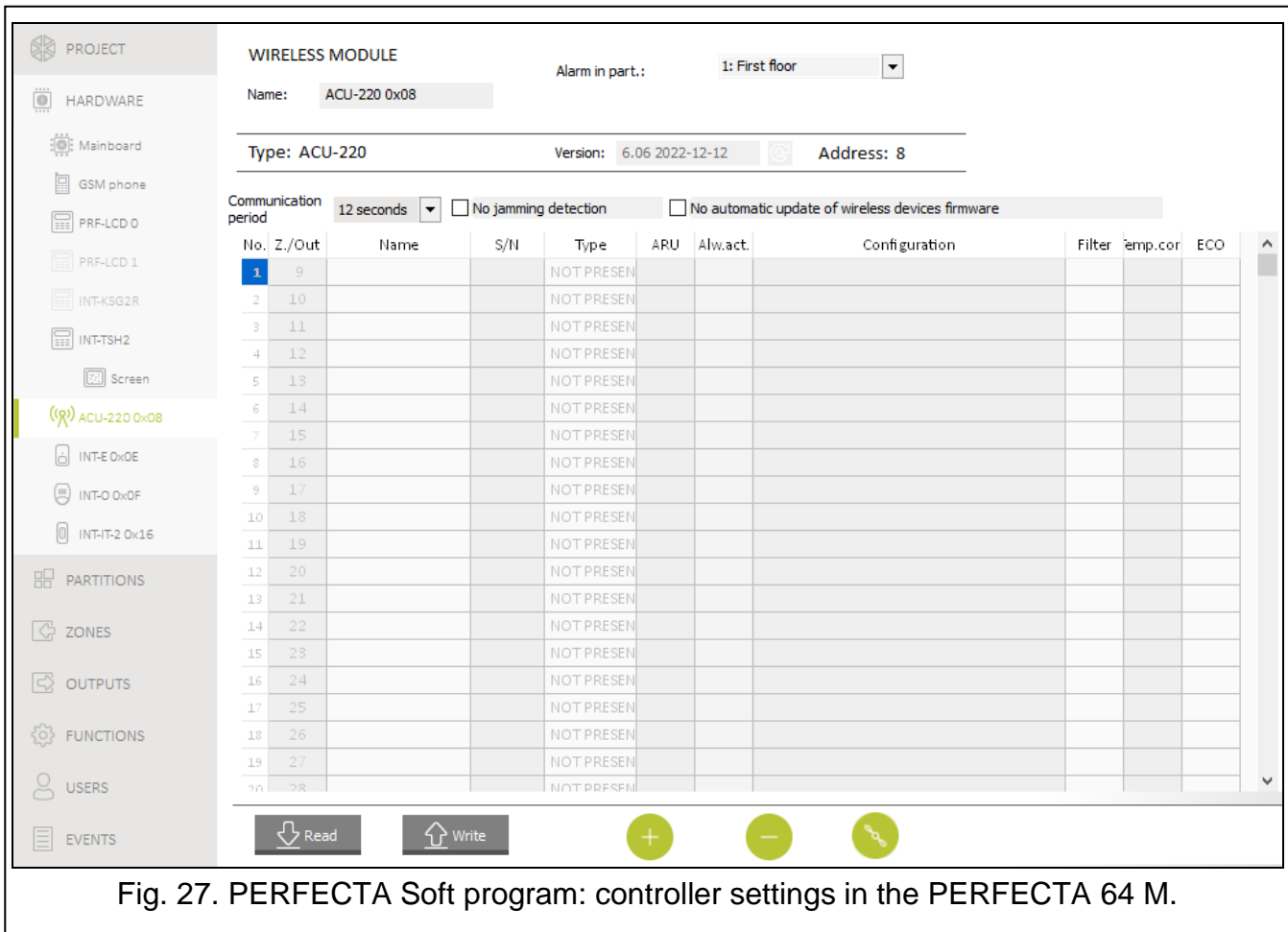

PROJECT

HARDWARE

Mainboard

GSM phone

PRF-LCD 0

PRF-LCD 1

INT-KSG2R

INT-TSH2

Screen

ACU-220 0x08

INT-E 0x0E

INT-O 0x0F

INT-IT-2 0x16

PARTITIONS

ZONES

OUTPUTS

FUNCTIONS

USERS

EVENTS

WIRELESS MODULE

Alarm in part.: 1: First floor

Name: ACU-220 0x08

Type: ACU-220

Version: 6.06 2022-12-12

Address: 8

Communication period: 12 seconds

No jamming detection

No automatic update of wireless devices firmware

No.	Z./Out	Name	S/N	Type	ARU	Alw.act.	Configuration	Filter	Temp.cor	ECO
1	9			NOT PRESEN						
2	10			NOT PRESEN						
3	11			NOT PRESEN						
4	12			NOT PRESEN						
5	13			NOT PRESEN						
6	14			NOT PRESEN						
7	15			NOT PRESEN						
8	16			NOT PRESEN						
9	17			NOT PRESEN						
10	18			NOT PRESEN						
11	19			NOT PRESEN						
12	20			NOT PRESEN						
13	21			NOT PRESEN						
14	22			NOT PRESEN						
15	23			NOT PRESEN						
16	24			NOT PRESEN						
17	25			NOT PRESEN						
18	26			NOT PRESEN						
19	27			NOT PRESEN						
20	28			NOT PRESEN						

Read Write + -

Fig. 27. PERFECTA Soft program: controller settings in the PERFECTA 64 M.

**No jamming detection** – if this option is enabled, the controller will not detect radio communication jamming.

**No automatic update of wireless devices firmware** – if this option is enabled, the firmware of wireless devices registered in the controller is not updated automatically.

### 8.2.1.1 Wireless devices



*The wireless keypads form a separate category of devices. A separate pool of positions is provided for them in the controller. Therefore, the keypads are not presented on the list of ABAX 2 wireless devices.*

**No.** – position number on the list of devices in the controller.

**Z./Out** – number of the zone/output to which the wireless device is assigned.

**Name** – name of the zone to which the wireless device is assigned.

**S/N** – serial number of the wireless device.

**Type** – type of the wireless device.

**ARU** – parameter available for the wireless device, if the ARU-200 radio signal repeater is registered to the controller. It defines whether the device is to communicate with the controller directly or via the selected ARU-200 radio signal repeater (several ARU-200 radio signal repeaters can be registered to the controller).

**Alw.act.** – the option is available for most of the wireless detectors. If it is enabled, the detector is permanently switched over to the active mode.



*The battery life time in the detectors switched permanently into the active mode is shorter than in those which are periodically switched to the passive mode.*

**Configuration** – for some devices you can configure additional settings (see: “Programming devices in the PERFECTA Soft program” p. 59).

**Filter** – the number of consecutive communication periods without connection between the device and the controller after which loss of communication with the device will be reported. You can enter values from 0 to 50. If you enter 0, you will disable the check for device presence.

**Temp.corr.** – you can correct the temperature information sent by the device by up to  $\pm 3.5^{\circ}\text{C}$ .

**ECO** – if this option is enabled, periodical communication with the device takes place every 3 minutes. This can extend the battery life up to four times.



*If you enable the “ECO” option for:*

*detector – delay between arming / disarming and switching the detector operating mode (active / passive) can be up to three minutes,*

*ASP-215 siren – delay in starting / stopping the signaling can be up to three minutes.*

## Buttons

**Read** – click to read data from the controller.

**Write** – click to save data to the controller.



– click to display information. This button is available when it is necessary to identify devices after a wireless device has been added / deleted.



– click to add the wireless device (see: “Adding new wireless devices” p. 37).



– click to remove the wireless device (see: “Removing wireless devices” p. 39).



– click to start the test mode. When the system is running in the test mode:

- detector LEDs are enabled,
- tamper signaling in the sirens is blocked.



– click to end the test mode.



*As required by EN 50131, the level of radio signal sent by wireless devices is lowered when the system is running in the test mode.*

*The command to start/end the test mode is sent during periodical communication, i.e. with delay whose duration depends on the frequency of periodical communication.*

*The test mode will be disabled automatically 30 minutes after:*

- exiting the controller settings,
- closing the PERFECTA SOFT program.

## 8.2.2 Programming devices in the PERFECTA Soft program

**ACD-220** – wireless curtain detector.

**Sensitivity** – detection sensitivity. You can select: low, medium or high.

**ADD-200** – wireless outdoor dusk and temperature detector. For the dusk detector you can configure:

**Sensitivity** – detection sensitivity. You can select a number from 1 to 16 (1 – minimum; 16 – maximum).

For the temperature detector you can configure the temperature threshold settings:

**Temperature threshold** – threshold type. You can select:

**H** – high (alarm when the temperature rises above the threshold temperature by a value equal to or higher than the tolerance),

**L** – low (alarm when the temperature drops below the threshold temperature by a value equal to or higher than the tolerance).

**Temperature** – threshold temperature. You can enter a value from -30°C to 70°C (with accuracy to 0.5°).

**Tolerance** – difference between the threshold temperature and the temperature at which the detector reports alarm. You can enter a value from 0.5°C to 10°C (with accuracy to 0,5°).

**AGD-200** – wireless glass-break detector.

**Sensitivity** – detection sensitivity. You can select: low, medium or high.

**AMD-202** – wireless magnetic contact with input for roller shutter detector. The following settings are available for the roller shutter input:

**Pulses number** – number of pulses after which the roller shutter input will generate alarm. You can select a number from 1 to 8.

**Counting time** – time in which pulses must be detected so that the roller shutter input generates alarm. You can select 30 seconds, 120 seconds, 240 seconds or “---“ (unlimited time).

**AOCD-260** – wireless outdoor dual technology curtain detector.

**PIR sensitivity** – PIR sensor sensitivity. You can select a number from 1 to 4 (1 - minimum; 4 – maximum).

**MW sensitivity** – microwave sensor sensitivity. You can select a number from 1 to 8 (1 - minimum; 8 – maximum)).

**AOD-210** – wireless outdoor dual technology motion detector.

**PIR sensitivity** – PIR sensor sensitivity. You can select a number from 1 to 4 (1 - minimum; 4 – maximum).

**MW sensitivity** – microwave sensor sensitivity. You can select a number from 1 to 8 (1 - minimum; 8 – maximum).

**Dusk det. sensitivity** – dusk sensor sensitivity (detection threshold). You can select a number from 1 to 4 (1 – minimum; 4 – maximum).

**APD-200** – wireless passive infrared detector.

**Sensitivity** – detection sensitivity. You can select: low, medium or high.

**APD-200 Pet** – wireless passive infrared detector with pet immunity up to 20 kg.

**Sensitivity** – detection sensitivity. You can select: low, medium or high.

**APMD-150 (APMD-250)** – wireless dual technology motion detector.

**PIR sensitivity** – PIR sensor sensitivity. You can select a number from 1 to 4 (1 - minimum; 4 – maximum).

**MW sensitivity** – microwave sensor sensitivity. You can select a number from 1 to 8 (1 - minimum; 8 – maximum).

**Test mode** – operation in the test mode:

**PIR & MW** – alarm after motion is detected by both sensors,

- PIR** – alarm after motion is detected by PIR sensor,
- MW** – alarm after motion is detected by microwave sensor.

**ARD-200** – wireless reorientation detector.

**Sensitivity** – detection sensitivity. You can select a number from 1 to 16 (1 – minimum; 16 – maximum).

**ART-200** – wireless radiator thermostat.

**Temp. measurement** – sensor that provides information on temperature. You can select “internal” (built-in thermostat sensor) or the zone to which an ABAX 2 device with temperature sensor is assigned.

**Controlling thermostat** – control panel thermostat whose settings are used by the ART-200 radiator thermostat.

**Temp. T1 (econ.)** – information on temperature T1 set for the controlling thermostat.

**Temp. T2 (comf.)** – information on temperature T2 set for the controlling thermostat.

**Shutdown output** – alarm system output that shuts down the remote switching of the thermostat operating mode. When the output is activated, the “Manual setting of the valve position / temperature” mode is enabled.

**ASD-150 (ASD-250)** – wireless smoke detector.

**Alarm from other detectors** – if this option is enabled, the detector signals alarm from other ASD-250 detectors.

**Transmit alarm** – if this option is enabled, the detector sends alarm to other ASD-250 detectors.

**ASP-200** – wireless outdoor siren.

**Signaling time** – maximum time of signaling. You can select: 1, 3, 6 or 9 minutes.

**Sound** – type of acoustic signaling. You can select one of four sounds described in Table 11.



<b>1</b>	Two sound frequencies (1450 Hz/2000 Hz) alternating within 1 second.	
<b>2</b>	Sound with rising frequency (from 1450 Hz to 2000 Hz) within 1 second.	
<b>3</b>	Sound with smoothly rising and falling frequency (1450 Hz – 2000 Hz – 1450 Hz) within 1 second.	
<b>4</b>	Sound with falling frequency (from 2000 Hz to 1450 Hz) within 1 second.	

Table 11. Types of acoustic signaling available for the ASP-200 siren.

**ASP-215** – wireless indoor siren. You can configure the signaling parameters for both positions occupied by the siren (which enables two different types of signaling to be programmed):

**Signaling time** – maximum time of signaling. You can select: 1, 3, 6 or 9 minutes.

**Sound** – type of acoustic signaling. You can select “NOT PRESENT” (signaling disabled) or one of three sounds described in Table 12.

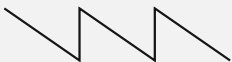
**Optical signaling** – if this option is enabled, the optical signaling is triggered.



<b>1</b>	Two sound frequencies (1450 Hz/2000 Hz) alternating within 1 second.	
<b>2</b>	Sound with rising frequency (from 1450 Hz to 2000 Hz) within 1 second.	
<b>3</b>	Sound with falling frequency (from 2000 Hz to 1450 Hz) within 1 second.	

Table 12. Types of acoustic signaling available for the ASP-215 siren.

**ASW-200** – 230 VAC smart plug.

**Operating mode** – way to control the device connected to the plug. You can select:

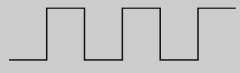
**0** – only remote control.

**1** – remote or manual control.

**2** – remote or manual control but with option to manually block the remote control.

**ASW-210** – flush-mounted wireless two-channel 230 VAC controller. For each position occupied by the controller, you can configure:

**Operating mode** – way to control the device connected to the relay output. You can select:

**0** – only remote control.

**1** – remote control or control with a monostable switch connected to the controller input.

**2** – remote control or control with a bistable switch connected to the controller input.

**ATD-200** – wireless temperature detector. For both positions occupied by the detector, you can configure the temperature threshold settings (which enables two different temperature thresholds to be programmed):

**Temperature threshold** – threshold type. You can select:

**H** – high (alarm when the temperature rises above the threshold temperature by a value equal to or higher than the tolerance),

**L** – low (alarm when the temperature drops below the threshold temperature by a value equal to or higher than the tolerance).

**Temperature** – threshold temperature. You can enter a value from  $-30^{\circ}\text{C}$  to  $70^{\circ}\text{C}$  (with accuracy to  $0.5^{\circ}$ ).

**Tolerance** – difference between the threshold temperature and the temperature at which the detector reports alarm. You can enter a value from  $0.5^{\circ}\text{C}$  to  $10^{\circ}\text{C}$  (with accuracy to  $0.5^{\circ}$ ).

**ATX-230** – hardwired zone expander: NC and roller shutter. For the roller shutter input, the following settings are available:

**Pulses number** – number of pulses after which the roller shutter input will generate alarm. You can select a number from 1 to 8.

**Counting time** – time in which pulses must be detected so that the roller shutter input generates alarm. You can select 30 seconds, 120 seconds, 240 seconds or “---“ (unlimited time).

**AVD-200** – wireless shock detector and magnetic contact. For the shock detector, you can configure:

**Sensitivity** – detection sensitivity. You can select a number from 1 to 8 (1 – minimum; 8 – maximum).

### 8.2.3 Specific character of the wireless devices operation

When programming the alarm system zones and outputs to which the wireless devices are assigned, you must take into account the specific character of operation of individual devices.



### 8.2.3.1 Wireless detectors

The zone to which a wireless detector is assigned is activated when the detector reports alarm (select the appropriate zone type). If a detector tamper is to generate the tamper alarm, program the zone as 2EOL/NC or 2EOL/NO.

Operation of the detector is affected by the state of partition to which the zone belongs:

**partition disarmed** – the detector operates in **passive mode**. This operating mode prolongs the battery life. Detector informs the controller about its status during periodical communication (only the tamper information is sent immediately).

**partition armed** – the detector operates in **active mode**. Detector informs the controller about alarm or tamper immediately.

Switching the detector from passive mode to active and vice versa takes place during periodical communication. It results in a delay whose duration depends on the frequency of periodical communication (with the “ECO” option enabled, delay can be up to 3 minutes).

Detectors assigned to the zones that are always armed are permanently in the active mode.

For most detectors, you can enable the “Always active” option.



*According to the EN 50131-3 standard all ABAX 2 system Hold-Up devices must be always in active mode.*

*The battery life in the detectors switched permanently to the active mode is shorter than in those which are periodically switched to the passive mode. However, if the specific character of a detector or its installation place is such that the number of alarms is low, switching the detector permanently into the active mode will not have a significant effect on the battery life.*

### 8.2.3.2 Wireless sirens

Turning on the output to which the wireless siren is assigned will trigger the signaling. Depending on the siren:

**ASP-200** – the first output controls the acoustic signaling, the second – the optical signaling. Thanks to a high-capacity battery, the siren can receive transmissions from the controller at any time. Therefore, the commands to start/stop signaling are sent to the siren immediately.

**ASP-215** – both outputs can control the acoustic and optical signaling. This enables two different, independently triggered types of signaling to be configured. The outputs can control separately the acoustic and optical signaling or trigger other signaling for different alarms (e.g. burglary and fire). Given its low-capacity battery, the siren can receive transmissions from the controller during periodical communication only. Therefore, the commands to start/stop signaling are sent to the siren during periodical communication. Consequently, the operating time of outputs controlling the siren should be longer than the communication period.

The signaling will stop after the maximum signaling time expires, even if the output is still active.

The zones to which the wireless siren is assigned are activated in the following cases (select the appropriate zone type):

**ASP-200** – first zone: starting the acoustic signaling; second zone: starting the optical signaling.

**ASP-215** – both zones: starting the signaling.

If the siren tamper is to generate tamper alarm, program the zone as 2EOL/NC or 2EOL/NO. The tamper information is sent immediately. Other types of information are sent during periodical communication.

Signaling of tamper alarm (on opening the tamper switch in the siren) continues for:

**ASP-200** – the maximum duration of signaling programmed for the siren (programmed sound type and optical signaling),

**ASP-215** – 3 minutes (type 1 sound and optical signaling).



*Tamper signaling is blocked:*

- when the control panel is running in service mode,
- when the ABAX 2 system is running in test mode,
- for 10 minutes after connecting the battery (ASP-200),
- for 40 seconds after installing the battery (ASP-215).

*It enables installation work to be carried out. Opening the tamper switch will not trigger signaling, but information on tamper will be sent. The command to block / unblock the signaling in relation to starting / ending the test mode or the service mode is sent during the response time.*

### 8.2.3.3 Wireless expanders of hardwired zones and outputs

You can configure the alarm system zone / output to which expander zone / output is assigned in much the same way as hardwired zones / outputs. You must, however, keep in mind the following rules for zone sensitivity:

- from 20 ms to 140 ms – expander supports all programmed values;
- above 140 ms – expander supports only some values: 400 ms, 500 ms, 700 ms, etc. every 200 ms (the programmed value is rounded up to that supported by the expander).



*The EN50131-3 standard requires that zones must react to signals lasting more than 400 ms. Therefore, select 400 ms when programming sensitivity of the alarm zones.*

Information on the state of zones and commands to change the state of outputs are sent immediately. Zone settings are sent during periodical communication.



*If communication with the controller is lost, all previously activated outputs will be deactivated after 20 communication periods.*

If the ACX-220 expander is powered from a SATEL power supply connected to the APS connector, the low battery information provided by the control panel means:

first zone – power supply overload,

second zone – low battery,

third zone – AC mains loss.

### 8.2.3.4 Smart plug / 230 VAC wireless controller

Turning on the output to which the plug / controller is assigned turns on the relay controlling the 230 VAC circuit (turns on the device connected to the plug / controller).

The zone to which the plug / controller is assigned is activated when:

- operating modes 1 and 2: the relay controlling the 230 VAC circuit is turned on,
- operating mode 0: the plug button is pressed / the controller input is activated.

Select the appropriate zone type.



*If the ASW-210 controller occupies one position on the list of wireless devices, only the first controller input (SW1) is supported and the state of both relays changes simultaneously.*

### 8.2.3.5 Wireless radiator thermostat

The thermostat operates as defined by the settings of the selected control panel thermostat (see the control panel programming manual). Select the controlling thermostat while programming the ART-200 thermostat settings. When the controlling thermostat's first temperature threshold (temperature T1) is active, the ART-200 thermostat operates in the "Economy temperature" mode. When the controlling thermostat's second temperature threshold (temperature T2) is active, the ART-200 thermostat operates in the "Comfort temperature" mode.

While programming the ART-200 thermostat settings, you can select an output that will disable the capability to switch between operating modes as described above. If this output is turned on, the thermostat operates in the "Manual setting of the valve position / temperature" mode. The thermostat can only be controlled manually then. If this output is turned off, the thermostat operates as defined by the controlling thermostat settings.



*If the "Edit without code" option is enabled in the control panel thermostat settings, the user will not be able to control the ART-200 thermostat manually (the thermostat keys will be blocked).*

The zone to which the ART-200 thermostat is assigned is active when the radiator valve is open (set in position other than fully closed). When the zone is in normal state, the valve is fully closed (it is 0% open). If tamper alarm is to be generated whenever the anti-freeze protection is activated (when temperature drops below 5°C), program the zone as 2EOL/NC or 2EOL/NO.

Information on the position of the valve and the anti-freeze protection being activated is sent during periodical communication.

Controlling the thermostat is impossible when the following errors occur: F01 – problem with changing the valve position, F02 – wrong calibration, F03 – low battery. The errors will be indicated as no communication with the thermostat.

### 8.2.3.6 Radio signal repeater

The first zone to which the radio signal repeater is assigned is activated in the event of 230 VAC mains loss (select the appropriate zone type).

The second zone to which the radio signal repeater is assigned is activated in the event of battery trouble (select the appropriate zone type).



If tamper of the radio signal repeater is to generate tamper alarm, program the zone as 2EOL/NC or 2EOL/NO.

## 8.3 Universal module of wireless devices

---

To configure the wireless system settings, you can use the ABAX 2 Soft program (see "ABAX 2 Soft program" p. 18).

### 8.3.1 Programming devices using the ABAX 2 Soft program

Before making any changes, click , and after making the changes – click .

**ACD-220** – wireless curtain detector. You can configure:

**Sensitivity** – select low, medium or high.

**ACX-210** – miniature hardwired zone / output expander. For each position taken up by the expander, you can configure:

**Wiring type** – select NC; NO; EOL; 2EOL/NC or 2EOL/NO.

**Reaction time** – define how long the zone must remain activated so that this can be registered by the controller. You can program from 20 to 5000 ms (in the range of 20 ms

to 140 ms, every 20 ms; above 140 ms, only some values are available: 400 ms, 500 ms, 700 ms, etc. every 200 ms).



*The EN 50131-3 standard requires that zones must react to signals lasting more than 400 ms. Therefore, select 400 ms when programming sensitivity of the alarm zones.*

**ACX-220** – hardwired zone / output expander. For each position taken up by the expander, you can configure:

**Wiring type** – select NC; NO; EOL; 2EOL/NC or 2EOL/NO.

**Reaction time** – define how long the zone must remain activated so that this can be registered by the controller. You can program from 20 to 5000 ms (in the range of 20 ms to 140 ms, every 20 ms; above 140 ms, only some values are available: 400 ms, 500 ms, 700 ms, etc. every 200 ms).



*The EN 50131-3 standard requires that zones must react to signals lasting more than 400 ms. Therefore, select 400 ms when programming sensitivity of the alarm zones.*

**ADD-200** – wireless outdoor dusk and temperature detector. For the dusk sensor, you can configure:

**Sensitivity** – select a number from a range of 1 to 16 (1 – minimum; 16 – maximum).

For the temperature sensor, you can configure:

**Temperature threshold** – select the threshold type:

**H** – high (when the temperature rises above the defined value, alarm will be generated),

**L** – low (when the temperature drops below the defined value, alarm will be generated).

**Temperature** – enter a number from a range of -30 to +70 (with 0.5 accuracy) to define temperature.

**Tolerance** – enter a number from a range of 0.5 to 10 (with 0.5 accuracy) to define tolerance.

**AGD-200** – wireless glass-break detector. You can configure:

**Sensitivity** – select low, medium or high.

**AMD-202** – wireless magnetic contact with input for roller shutter detector. For the roller shutter input, you can configure:

**Pulses number** – select the number of pulses after which the roller shutter input will generate alarm. You can select a number from a range of 1 to 8.

**Counting time** – select the time period during which the defined number of pulses must occur for the roller shutter input to generate alarm. You can select 30 seconds, 120 seconds, 240 seconds or “---“ (unlimited time).

**AOCD-260** – wireless outdoor dual technology curtain detector. You can configure:

**PIR sensitivity** – select a number from a range of 1 to 4 (1 – minimum; 4 – maximum).

**MW sensitivity** – select a number from a range of 1 to 8 (1 – minimum; 8 – maximum).

**AOD-210** – wireless outdoor dual technology motion detector. You can configure:

**PIR sensitivity** – select a number from a range of 1 to 4 (1 – minimum; 4 – maximum).

**MW sensitivity** – select a number from a range of 1 to 8 (1 – minimum; 8 – maximum).

**Dusk det. sensitivity** – select a number from a range of 1 to 4 (1 – minimum; 4 - maximum).

**APD-200** – wireless passive infrared detector. You can configure:

**Sensitivity** – select low, medium or high.

**APD-200 Pet** – wireless passive infrared detector with pet immunity up to 20 kg. You can configure:

**Sensitivity** – select low, medium or high.

**APMD-250** – wireless dual technology detector. You can configure:

**PIR sensitivity** – select a number from a range of 1 to 4 (1 – minimum; 4 – maximum).

**MW sensitivity** – select a number from a range of 1 to 8 (1 – minimum; 8 – maximum).

**Test mode** – select how the detector should work in the test mode:

**PIR & MW** – alarm after motion is detected by both sensors,

**PIR** – alarm after motion is detected by PIR sensor,

**MW** – alarm after motion is detected by microwave sensor.

**ARD-200** – wireless reorientation detector. You can configure:

**Sensitivity** – select a number from a range of 1 to 16 (1 – minimum; 16 – maximum).

**ART-200** – wireless radiator thermostat. You can configure:

**Comfortable temp.** – enter a number from a range of 5 to 30 (with accuracy to 0.5) to define the temperature for the “Comfortable temperature” operating mode.

**Economic temp.** – enter a number from a range of 5 to 30 (with accuracy to 0.5) to define the temperature for the “Economic temperature” operating mode.

**Temp. measurement** – select the sensor that will provide data on temperature:

**internal** – thermostat sensor,

**[Device name]** – temperature sensor of an ABAX 2 system device.

**Head keys disabled** – enable this option if you want to disable the thermostat keys.

**ASD-250** – wireless smoke detector. You can configure:

**Alarm from other detectors** – enable the option if the detector is to signal alarm from other ASD-250 detectors.

**Alarm propagation** – enable the option if the detector is to send alarm to other ASD-250 detectors.

**ATD-200** – wireless temperature detector. For both positions occupied by the detector, you can configure:

**Temperature threshold** – select the threshold type:

**H** – high (when the temperature rises above the defined value, alarm will be generated),

**L** – low (when the temperature drops below the defined value, alarm will be generated).

**Temperature** – enter a number from a range of -30 to +70 (with 0.5 accuracy) to define temperature.

**Tolerance** – enter a number from a range of 0.5 to 10 (with 0.5 accuracy) to define tolerance.

**ATX-230** – hardwired zone expander: NC and roller shutter. For the roller shutter input, you can configure:

**Pulses number** – select the number of pulses after which the roller shutter input will generate alarm. You can select a number from a range of 1 to 8.

**Counting time** – select the time period during which the defined number of pulses must occur for the roller shutter input to generate alarm. You can select 30 seconds, 120 seconds, 240 seconds or “---” (unlimited time).

**AVD-200** – wireless shock detector and magnetic contact. For the shock detector you can configure:

**Sensitivity** – select a number from a range of 1 to 8 (1 – minimum; 8 – maximum).

**ASP-200** – wireless outdoor siren. You can configure:

**Signaling time** – select the maximum time of signaling: 1 minute, 3 minutes, 6 minutes or 9 minutes.

**Sound** – select the type of acoustic signaling: 1 (sound type 1), 2 (sound type 2), 3 (sound type 3) or 4 (sound type 4) – see Table 13.





<b>1</b>	Two sound frequencies (1450 Hz/2000 Hz) alternating within 1 second.	
<b>2</b>	Sound with rising frequency (from 1450 Hz to 2000 Hz) within 1 second.	
<b>3</b>	Sound with smoothly rising and falling frequency (1450 Hz – 2000 Hz – 1450 Hz) within 1 second.	
<b>4</b>	Sound with falling frequency (from 2000 Hz to 1450 Hz) within 1 second.	

Table 13. Types of acoustic signaling available in the ASP-200 siren.

**ASP-215** – wireless indoor siren. For each position taken up by the siren, you can configure:

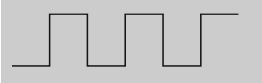
**Signaling time** – select the maximum time of signaling: 1 minute, 3 minutes, 6 minutes or 9 minutes.

**Sound** – select the type of acoustic signaling: not present (signaling disabled), 1 (sound type 1), 2 (sound type 2) or 3 (sound type 3) – see Table 14.

**Optical signaling** – if this option is enabled, the optical signaling is triggered.



<b>1</b>	Two sound frequencies (1450 Hz/2000 Hz) alternating within 1 second.	
<b>2</b>	Sound with rising frequency (from 1450 Hz to 2000 Hz) within 1 second.	
<b>3</b>	Sound with falling frequency (from 2000 Hz to 1450 Hz) within 1 second.	

Table 14. Types of acoustic signaling available in the ASP-215 siren.

**ASW-200** – 230 VAC smart plug. You can configure:

**Operating mode** – 0 (only remote control), 1 (remote or manual control) or 2 (remote or manual control, but with option to manually block the remote control).

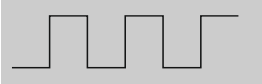
**ASW-210** – flush-mounted wireless two-channel 230 VAC controller. For each position occupied by the controller you can configure:

**Operating mode** – select 0 (relay can only be controlled via the controller), 1 (the input enables relay to be controlled with monostable switch) or 2 (the input enables relay to be controlled with bistable switch).

### 8.3.2 Specific character of the operation of wireless devices

When selecting the devices that will control the controller inputs, and the devices to be controlled by the controller outputs, take into account the specific character of operation of each device.

**i** *If the controller is integrated with another system using the RS-485 bus, inputs and outputs of the controller are not supported. For controlling wireless devices and reading information about their state, the Modbus RTU protocol is used (see “RS-485 bus” p. 11).*

### 8.3.2.1 Wireless detectors

The state of input to which the detector is assigned has effect on the detector operating mode:

**input in normal state** – the detector operates in **passive mode**. This operating mode prolongs the battery life. Detector informs the controller about its status during periodical communication (only the tamper information is sent immediately).

**input activated** – the detector operates in **active mode**. Detector informs the controller about alarm or tamper immediately.

To control the controller inputs you can use e.g. the control panel outputs (OC type or relay). The control panel output can be programmed e.g. as “Armed status”. Arming the control panel will switch the detectors into active state, and disarming – into passive state.

Switching the detector from passive mode to active and vice versa takes place during periodical communication. It results in a delay whose duration depends on the frequency of periodical communication (with the “ECO” option enabled, delay can be up to 3 minutes).

For most detectors, you can enable the “Always active” option.



*According to the EN 50131-3 standard all ABAX 2 system Hold-Up devices must be always in active mode.*

*The battery life time in the detectors switched permanently into the active mode is shorter than in those which are periodically switched to the passive mode. However, if the specific character of a detector or its installation place is such that the number of alarms is low, switching the detector permanently into the active mode will not have a significant effect on the battery life.*

The output to which the detector is assigned is active when the detector reports alarm.

### 8.3.2.2 Wireless sirens

Activating the input to which the wireless siren is assigned will trigger signaling. Depending on the siren:

**ASP-200** – the input assigned to the first position controls the acoustic signaling, and the input assigned to the second position – the optical signaling. Thanks to a high-capacity battery, the siren can receive transmissions from the controller at any time. Therefore, the commands to start/stop signaling are sent to the siren immediately.

**ASP-215** – the inputs assigned to both positions can control the acoustic and optical signaling. This enables two different, independently triggered types of signaling to be configured. The inputs can control separately the acoustic and optical signaling or trigger other signaling for different alarms (e.g. burglary and fire). Given its low-capacity battery, the siren can receive transmissions from the controller during periodical communication only. Therefore, the commands to start/stop signaling are sent to the siren during periodical communication. Consequently, the operating time of outputs controlling the siren should be longer than the communication period.

The signaling will stop after the maximum signaling time expires, even if the input is still active.

The outputs to which the wireless siren is assigned indicate the state of signaling. Information about the state of signaling is sent during periodical communication.

### 8.3.2.3 Wireless expanders of hardwired zones and outputs

The controller input to which the expander output is assigned controls the operation of that output. The controller output to which the expander zone is assigned, indicates the state of that zone.

Information on the state of zones and commands to change the state of outputs are sent immediately. The zone settings are sent during periodical communication.



*If communication with the controller is lost, all previously activated outputs will be deactivated after 20 communication periods.*

If the ACX-220 expander is powered from a power supply connected to the APS connector, the information about power trouble presented in the ABAX 2 Soft program has the following meaning:

first position – power supply overload,

second position – low battery,

third position – AC mains loss.

#### **8.3.2.4 Smart plug / Wireless 230 VAC controller**

Activation of the input which the plug / controller is assigned to turns on the relay controlling the 230 VAC circuit (turns on the device connected to the plug / controller).

The output which the plug / controller is assigned to is activated when:

- operating modes 1 and 2: the relay controlling the 230 VAC circuit is turned on,
- operating mode 0: plug button is pressed / controller input is activated.



*If the ASW-210 controller occupies one position on the list of wireless devices, only the first controller input (SW1) is supported and the state of both relays changes simultaneously.*

#### **8.3.2.5 Wireless radiator thermostat**

The input to which the thermostat is assigned is activated when the thermostat operates in the “Comfortable temperature” mode. When the thermostat operates in the “Economic temperature” mode, the input is in normal state.

You can enable the “Head keys disabled” option in the controller. When this option is enabled, the thermostat keys will be disabled.

During periodical communication the thermostat will inform the controller about the position of the radiator valve and the anti-freeze protection being activated. The information is displayed in the ABAX Soft program (see: “Devices status” p. 24) and can be read using the Modbus RTU communication protocol (see: “Table of Modbus RTU protocol registers” p 11).

Controlling the thermostat is impossible when the following errors occur: F01 – problem with changing the valve position, F02 – wrong calibration, F03 – low battery. The errors will be indicated as no communication with the thermostat.

#### **8.3.2.6 Radio signal repeater**

The output to which the first position of the radio signal repeater is assigned is turned on in the event of 230 VAC mains loss.

The output to which the second position of the radio signal repeater is assigned is turned on in the event of a battery trouble.

#### **8.3.2.7 Panic button**

The output to which the button is assigned will change its state when the button is pressed. To define the output operating mode, use the ABAX 2 Soft program in which you can configure the controller settings (see: “Configuration” p. 20).



## 9 APT-200 keyfobs

If the controller works as expander of wireless devices for SATEL alarm control panels, the number of supported keyfobs depends on the number of control panel users. When the controller works as universal module of wireless devices, it can support up to 256 keyfobs.



*Before adding a keyfob that was previously registered to the ABAX / ABAX 2 system, you must restart it (to do so, long press the ○ and ● buttons for 30 seconds or remove the battery for 30 seconds).*

### 9.1 Expander of wireless devices for SATEL alarm control panels



*The data related to keyfobs are stored in the controller. After the controller containing keyfob data is connected to the control panel, keyfobs will be automatically assigned to the existing users.*

#### 9.1.1 Keyfobs in the INTEGRA system

If two or more ABAX / ABAX 2 controllers are connected to the control panel, the keyfob will be supported by all of them. The keyfobs data are written automatically to all the controllers.

If you connect a controller to the INTEGRA 128-WRL control panel or a control panel to which an ABAX / ABAX 2 controller is already connected, the APT-200 keyfobs data must be unified. You can do it using:

- DLOADX program – in the “Keyfobs ABAX” window, click the “Read” button and, immediately after the data are read, click the “Write” button (after reading the data, you must not make any changes),
- LCD keyfob – use “Copy ABAX kfobs” function (service mode ► “Structure” ► “Hardware” ► “Expanders” ► “Copy ABAX kfobs”).



*The controller does not support the APT-100 keyfobs.*

Using the keyfob, the user can control up to 6 zones of the alarm system. These zones should not exist physically and the wiring type programmed in them must be different from “No detector” and “Follow output”. You can select any type for these zones. Pressing a keyfob button(s) will violate the zone.

After pressing any keyfob button (which do not have to control any system zone), information about the state of three selected system outputs is indicated for a few seconds by the keyfob LEDs. Thus you can get confirmation that the function has been executed or information on the current system status. The outputs whose state is presented on the keyfob LEDs do not have to exist physically.

You can indicate up to 8 outputs in the system which will be used to inform the keyfob users (“Keyfobs ABAX” window in the DLOADX program or “ABAX confirmat.” function in the LCD-keypad (service mode ► “Structure” ► “Hardware” ► “Expanders” ► “ABAX confirmat.”)).

For information on adding / removing keyfobs by means of the keypad please refer to the control panel user manual.



*Removing a keyfob only clears its serial number, but not its settings. If a new keyfob is added to the user, it will have the same settings as the removed one.*

*You can remove all keyfobs, including their settings, by means of the “Rem.ABAX keyfob” function available in the service mode in the keypad (► “Structure” ► “Hardware” ► “Expanders” ► “Rem.ABAX keyfob”).*

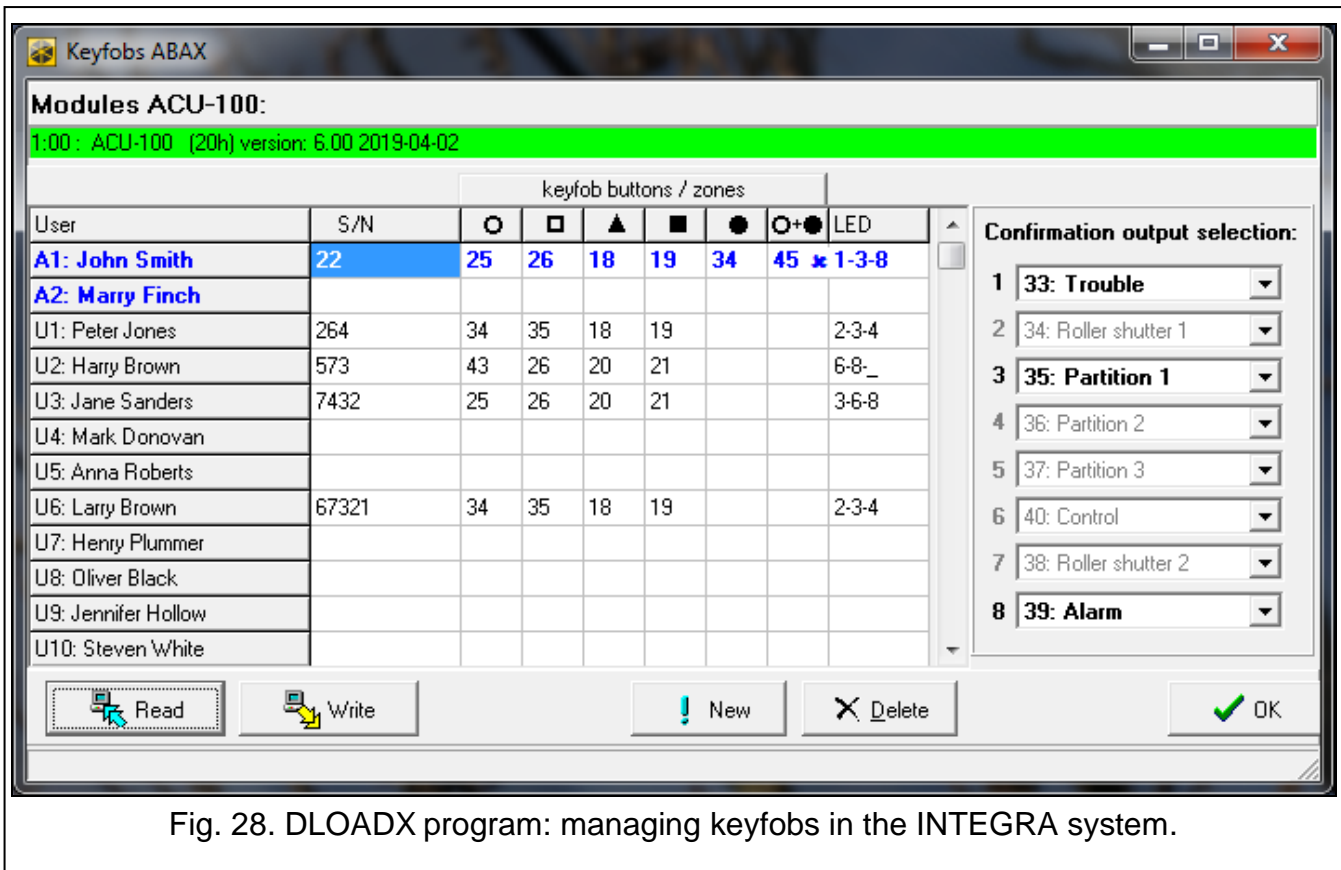



Fig. 28. DLOADX program: managing keyfobs in the INTEGRA system.

### 9.1.1.1 Keyfob management using the DLOADX program

You can manage the keyfobs in the “Keyfobs ABAX” window (Fig. 28). The window opening command is available in the “Users” menu. Before making any changes, click the “Read” button, and after making the changes – the “Write” button (the data related to keyfobs are not read and saved after clicking the  button in the program main menu).

#### Adding a keyfob

##### Entering the serial number manually

1. Click the field in the “S/N” column next to the name of the user to whom you want to assign a keyfob.
2. Enter the keyfob serial number and press ENTER.

##### Reading the serial number during transmission

1. Click the field in the “S/N” column next to the name of the user to whom you want to assign a keyfob.
2. Click the “New” button.
3. The “New” window will open.
4. Press the keyfob button.
5. When the keyfob serial number is displayed in the window, click the “OK” button.
6. The “New” window will close.
7. The serial number of the new keyfob will be shown in the “S/N” column.

##### Assigning a zone to keyfob button (combination of buttons)

1. Click the field corresponding to the button (combination of buttons).
2. Enter the zone number and press ENTER.

3. Using the SPACE key enable / disable the event generating function. If the ✕ symbol is displayed next to the zone number, the event will not be saved after pressing the button / combination of buttons (if no symbol is displayed, the event will be saved).

### Assigning outputs to the LEDs

1. Click the field in the “LED” column.
2. Using the keyboard, enter up to 3 digits. Each of the digits must correspond to the number of field with output selected for confirmation (on the window right side) i.e. it can be from the 1 to 8 range. The names of outputs in fields designated with these digits will be shown in bold-type face.

### Removing a keyfob

1. Click the field in “S/N” column next to the name of user whose keyfob is to be removed.
2. Click the “Delete” button.
3. The “Confirm” window will open.
4. Click the “Yes” button.
5. The “Confirm” window will close.
6. The keyfob serial number shown in the “S/N” column will be erased.



### 9.1.2 Keyfobs in the PERFECTA 64 M system

After a keyfob has been added, its settings will be configured automatically, based on the default settings (see: “Default keyfob settings” p. 75). These settings can be modified (different functions can be assigned to the buttons / combination of buttons and different information to the LEDs).

The user manual for the PERFECTA 64 M control panel describes the procedures for adding and editing the user by means of the keypad, during which you can add or remove the keyfob and program its settings.

#### 9.1.2.1 Keyfob management using the PERFECTA Soft program

You can manage the keyfobs in the “Users” tab (Fig. 29). Before making any changes to the keyfob settings, click the “Read” button, and after making the changes – the “Write” button.

The keyfob settings will not be read / written to the controller when you click  /  on the menu bar.

**Name** – user name.

**Serial number** – serial number of the keyfob. Each keyfob has a unique serial number used for user authentication.

**Keyfob buttons** – number of the function started on pressing the button. You can assign a different function to each keyfob button. Right-click the field to select a function from the list. The columns are labeled with the symbols corresponding to the keyfob buttons.

**Event** – if the ✓ symbol is displayed in the field, each use of the keyfob is saved to the event log. If the field is empty, using the keyfob is not saved to the event log. Double-click the field to make changes.

**Keyfob LEDs** – operating mode of the keyfob LED on pressing any button (the button does not need to start any function):

\* - LED is ON,

[empty field] – LED is OFF,

[number] – number of the output whose logic state is indicated by the LED (LED is ON – output activated; LED is OFF – output deactivated).

You can select a different operating mode for each keyfob LED. Right-click the field to select the LED operating mode from the list.

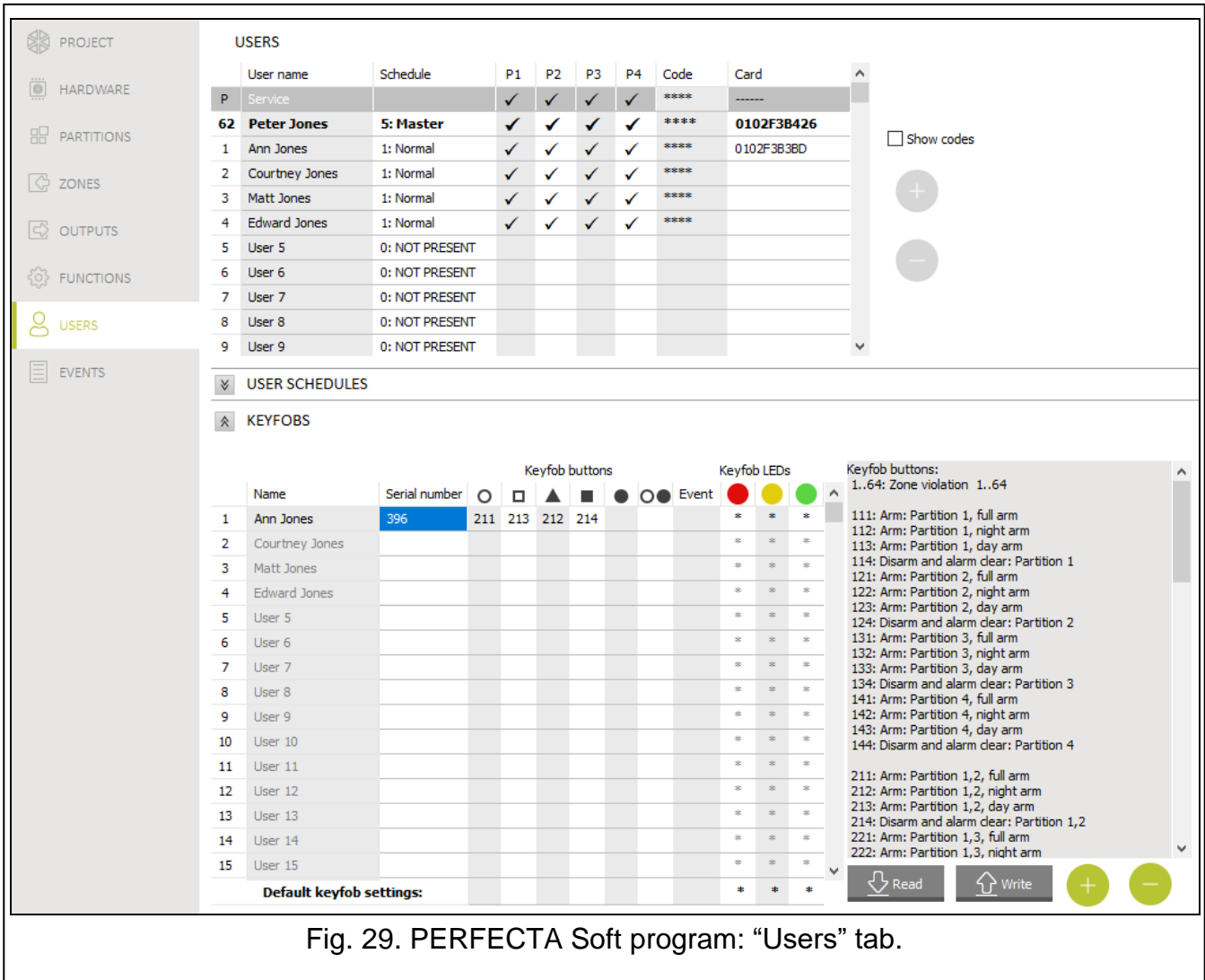

Fig. 29. PERFECTA Soft program: “Users” tab.

**Buttons**

**Read** – click to read the keyfob data from the controller.

**Write** – click to write the keyfob data to the controller.



– click to add the keyfob to the user.



– click to delete the user’s keyfob.

**Adding a keyfob**

1. Click the field in the “Serial number” column next to the name of the user to whom you want to add the keyfob.
2. Click . The keyfob adding panel will be displayed.
3. Use the “auto” option to select the keyfob adding method:
  - do not enable this option if you want to enter the keyfob serial number manually (this method is recommended when other keyfobs are used in the area, which makes it difficult to read the new keyfob’s serial number during transmission),
  - enable this option if you want the keyfob serial number to be read during transmission from the keyfob.

### **Entering serial number manually**

1. Enter the keyfob serial number in the “Serial number” field.
2. Press any keyfob button.
3. When the “Device’s data read” message is displayed, click “OK”. The keyfob adding panel will close.
4. Click the „Write” button to write the changes to the controller.

### **Reading serial number during transmission**

1. Press any keyfob button.
2. When the serial number will be displayed, make sure it is the serial number of the added keyfob, then press again any keyfob button.
3. When the “Device’s data read” message is displayed, click “OK”. The keyfob adding panel will close.
4. Click the „Write” button to write the changes to the controller.

### **Removing a keyfob**

1. Click the field in the “Serial number” column next to the name of the user from whom you want to remove the keyfob.
2. Click . The “Device deleting” window will be displayed.
3. Click “Delete”. The “Device deleting” window will close.
4. Click the „Write” button to write the changes to the controller.

### **Default keyfob settings**

You can configure the default keyfob settings (assign functions to buttons / define operating mode of LEDs). This makes it easier to add keyfobs because each new keyfob will be automatically configured based on the default settings. The settings of each keyfob can be later customized to the user needs and rights.



*Changing the default functions has no effect on the settings of keyfobs which are already added to the users.*

### **9.1.3 Keyfobs in the VERSA system**

The functions which can be started using the keyfobs and the information that can be presented on the LEDs are described in manuals for the VERSA series control panels.

After a keyfob has been added, its settings will be configured automatically, based on the user schedule. These settings can be modified (different functions can be assigned to the buttons / combination of buttons and different information to the LEDs).

The user manual for VERSA series control panels describes the procedures for adding and editing the user by means of the keypad, during which you can add or remove the keyfob and program its settings.





*Removing a keyfob only clears its serial number, but not its settings. If a new keyfob is added to the user, it will have the same settings as the removed one.*

*You can remove all keyfobs, including their settings, by means of the “Rem.ABAX kfbs” function available in the service mode in the keypad (►“2.Hardware” ►“1.Kpds. & exps.” ►“8.Rem.ABAX kfbs”).*

#### **9.1.3.1 Keyfob management using the DLOADX program**

You can add and delete keyfobs in the “Versa – Structure” window, “Hardware” tab, after clicking the controller name in the list of devices, and then on the “Keyfobs” tab (Fig. 30).

Before making any changes, click the “Read” button, and after making the changes – the “Write” button (the data relating to keyfobs are not read after clicking the  button or saved after clicking the  button in the DLOADX program main menu).

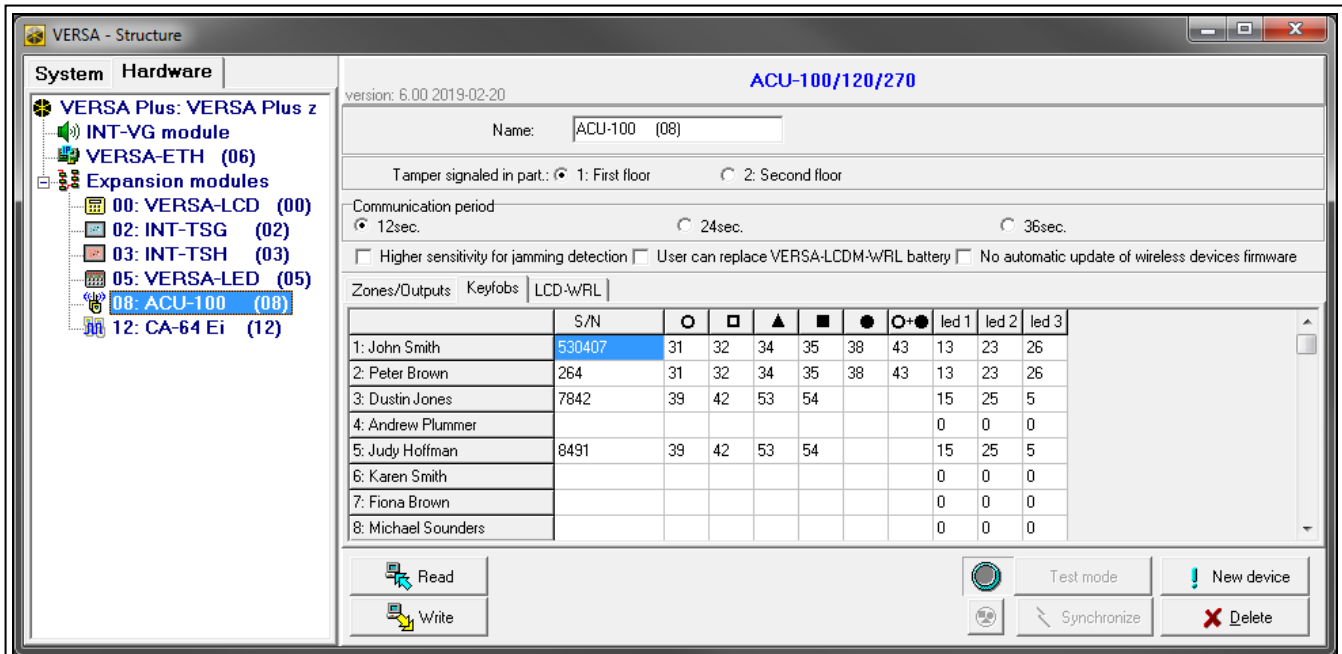

Fig. 30. DLOADX program: managing keyfobs in the VERSA system.

## Adding a keyfob

### Entering the serial number manually

1. Click the field in the “S/N” column next to the name of the user to whom you want to assign a keyfob.
2. Enter the keyfob serial number and press ENTER.

### Reading the serial number during transmission

1. Click the field in the “S/N” column next to the name of the user to whom you want to assign a keyfob.
2. Click the “New device” button.
3. The “New” window will open.
4. Press the keyfob button.
5. When the keyfob serial number is displayed in the window, click the “OK” button.
6. The “New” window will close.
7. The serial number of the new keyfob will be shown in the “S/N” column.

### Assigning a function to keyfob button (combination of buttons)

1. Right click the field corresponding to the button (combination of buttons).
2. The list of functions will be displayed.
3. Click the function to be run by the keyfob button (combination of buttons).

### Assigning information to a LED

1. Right click the field corresponding to the LED.
2. The list of information that can be presented by the LED will be displayed.
3. Click the information items to be presented.

## Removing a keyfob

1. Click the field in "S/N" column next to the name of user whose keyfob is to be removed.
2. Click the "Delete" button.
3. The "Confirm" window will open.
4. Click the "Yes" button.
5. The "Confirm" window will close.
6. The keyfob serial number shown in the "S/N" column will be erased.

## 9.2 Universal module of wireless devices

---

Using a keyfob, the user can control six outputs of the controller. Pressing a keyfob button(s) will turn on the output for a preset period of time or will change the output state to the opposite one. You can define how the outputs should operate when programming the controller settings from the ABAX 2 Soft program (see "Configuration" p. 20).

After pressing any keyfob button (which do not have to control any controller output), information about the state of three controller inputs will be presented on the keyfob LEDs for a few seconds. The LED is ON when:



- the NO type input is closed,
- the NC type input is open.

### 9.2.1 Keyfob management

You can manage the keyfobs using the ABAX 2 Soft program (see "ABAX 2 Soft program" p. 18).

Before making any changes, click  and after making the changes, click .

#### 9.2.1.1 Adding a keyfob

1. Click .
2. The "Adding keyfobs" window will open.
3. In the "Serial number" field, enter the serial number of the keyfob being added.
4. Press the keyfob button.
5. A message will confirm adding the keyfob (unless you have entered an invalid serial number, of which the message will inform you).
  - 5.1. Keyfob type will be displayed.
  - 5.2. Keyfob name will be displayed. You can change the name.
  - 5.3. You can select which position the keyfob is to take up on the list.
6. Click .
7. The "Adding keyfobs" window will close.
8. The new keyfob will be displayed on the list of keyfobs.

#### 9.2.1.2 Assigning an output to keyfob button (combination of buttons)

1. Click the field corresponding to the button (combination of buttons).
2. Enter the number of the controller programmable output and press ENTER.

#### 9.2.1.3 Assigning zones to LEDs

1. Click the field in the "LED" column.
2. Using the keyboard, enter up to 3 digits and press ENTER. Each of the digits must correspond to the number of controller input.

### 9.2.1.4 Removing a keyfob

1. Click the keyfob you want to remove.
2. Click .
3. The “Device deleting” window will open.
4. Click the “DELETE” button.
5. The “Device deleting” window will close.

## 10 Controller firmware update

---



*When its firmware is being updated, the controller does not perform its normal functions.*



*Remember to save the controller settings to file before the firmware update.*

1. Download the ACU-220 controller firmware update program from [www.satel.pl](http://www.satel.pl).
2. Connect the RS-232 (TTL) port of the controller to the USB port of the computer. To make the connection, use the USB-RS converter, offered by SATEL.
3. Run the module firmware update program.
4. Click the  button.
5. When the connection configuration window opens, select the computer COM port through which communication with the controller RS-232 (TTL) port is to take place.
6. When the prompt is displayed asking you whether to continue the firmware update, click “Yes”. The controller firmware will be updated.

### 10.1 Updating the firmware of ABAX 2 wireless devices

---

During the controller firmware update, programs enabling the update of the firmware of ABAX 2 system devices are also saved to the controller memory. If devices with outdated versions of firmware are registered in the controller, their firmware is updated by the controller automatically. The process of verification of the firmware of registered devices is run after each controller firmware update, as well as after adding new devices.

If attempts to automatically update the firmware of devices fail (e.g. as a result of radio signal interference or device power trouble), the  icon will be displayed in the ABAX 2 Soft program at the device firmware version. You can then click the  button (see “Devices status” p. 24 and “Keyfob state” p. 28) to restart the update process.



*At the final phase of the firmware update, the device does not perform its normal functions for a few seconds.*

*If you do not want the controller to automatically update the firmware of the devices registered in it, enable the “No automatic update of wireless devices firmware” option in the controller.*

## 11 Restoring the controller factory settings

---

1. Power off the controller.
2. If wires are connected to the controller communication bus, disconnect them.
3. Short together the terminals CKE and DTE.



4. Power on the controller. The LED indicating the status of communication with the control panel will start blinking.
5. When the factory default settings are restored, the LED will go off for a while and then it will go on with steady light.
6. Open the terminals CKE and DTE.
7. Power off the controller.
8. Reconnect the wires to the controller communication bus.
9. Power on the controller.

## 12 Battery replacement in ABAX 2 device



**There is a danger of battery explosion when using a different battery than recommended by the manufacturer, or handling the battery improperly.**

**Be particularly careful during installation and replacement of the batteries. The manufacturer is not liable for the consequences of incorrect installation of the battery.**

**The used batteries must not be discarded, but should be disposed of in accordance with the existing rules for environment protection.**

When the device indicates low battery, the battery must be replaced.



*When replacing the battery, wait about 1 minute between removing the old battery and installing the new one.*

After battery replacement, the device will inform the controller / control panel about its status during periodical communication. As a result, the information might be sent with delay whose duration depends on the frequency of periodical communication (if the “ECO” option is enabled, it can take up to 3 minutes).

## 13 Specifications

Operating frequency band .....	866 MHz / 868.0 MHz ÷ 868.6 MHz / 915 MHz – 928 MHz
Radio communication range (in open area) .....	up to 2000 m
Supply voltage .....	12 VDC ±15%
Standby current consumption .....	75 mA
Maximum current consumption .....	100 mA
OC type outputs .....	50 mA / 12 VDC
Security grade according to EN 50131-3 .....	Grade 2
Complied with standards..EN 50130-4, EN 50130-5, EN 50131-1, EN 50131-3, EN 50131-5-3	
Environmental class according to EN 50130-5 .....	II
Operating temperature range.....	-10°C...+55°C
Maximum humidity .....	93±3%
Electronics board dimensions .....	103 x 139 mm
Enclosure dimensions.....	126 x 158 x 32 mm
Weight.....	225 g

## 14 Manual update history

Manual version	Introduced changes
01/20	<ul style="list-style-type: none"> <li>• Section „Features” has been updated (p. 5).</li> <li>• Section „Terminals” has been updated (p. 7).</li> <li>• Section „RS-485 bus” has been added (p. 11).</li> <li>• Section „Preparing the cabling” has been updated (p. 15).</li> <li>• Section „Universal module of wireless devices” has been updated (p. 17).</li> <li>• Description of settings for configuring communication using the Modbus protocol has been added (p. 22).</li> <li>• Section „Battery replacement in ABAX 2 device” has been added (p. 79).</li> </ul>
09/20	<ul style="list-style-type: none"> <li>• Section “Table of Modbus RTU protocol registers” has been updated (p. 11).</li> </ul>
01/21	<ul style="list-style-type: none"> <li>• Section “Smart plug / Wireless 230 VAC controller” has been updated (p. 56).</li> <li>• Section “Smart plug / Wireless 230 VAC controller” has been updated (p. 70).</li> </ul>
10/21	<ul style="list-style-type: none"> <li>• Information about required firmware version of INTEGRA / INTEGRA Plus control panels has been updated (p. 5).</li> <li>• Section “Programmable outputs” has been updated (p. 10).</li> <li>• Section “Table of Modbus RTU protocol registers” has been updated (s. 11).</li> <li>• Information about required version of ABAX 2 Soft program has been added (p. 18).</li> <li>• Section “Devices status” has been updated (p. 24).</li> <li>• Section “Wireless devices supported by the controller” has been updated (p. 29).</li> <li>• Information about required version of DLOADX program has been added (p. 31 and 39).</li> <li>• Section “Device settings” has been updated (p. 45).</li> <li>• Section “Specific character of the operation of wireless devices” has been updated (p. 55).</li> <li>• Section “Programming devices using the ABAX 2 Soft program” has been updated (p. 65).</li> <li>• Section “Specific character of the operation of wireless devices” has been updated (p. 68).</li> </ul>
01/22	<ul style="list-style-type: none"> <li>• Information about required version of ABAX 2 Soft program has been updated (p. 18).</li> <li>• New information about the AXD-200 detector has been added (p. 30).</li> <li>• Information about required version of DLOADX program has been updated (p. 31 and 39).</li> <li>• Information about possibility to select device type for the AXD-200 detector while adding it to the system has been added (p. 34, 40 and 42).</li> <li>• Section “Device settings” has been updated (p. 45).</li> <li>• Section “Programming devices using the ABAX 2 Soft program” has been updated (p. 65).</li> </ul>
11/22	<ul style="list-style-type: none"> <li>• Information about required version of INTEGRA / INTEGRA Plus control panels firmware has been updated (p. 5).</li> <li>• Section “DIP-switches” has been updated (p. 7).</li> <li>• Section “Enabling / disabling the support of the unregistered ARF-200 tester” has been added (p. 9).</li> <li>• Information about required version of ABAX 2 Soft program has been updated (p. 18).</li> <li>• Description of the “No jamming detection” and “MODBUS” options has been added (p. 22).</li> <li>• Section „Registering devices to the controller” has been updated (p. 31).</li> <li>• Information about required version of DLOADX program has been updated (p. 31 and 39).</li> <li>• Description of the “No jamming detection” has been added (p. 44).</li> </ul>

	<ul style="list-style-type: none"> <li>• Section “Specific character of the operation of wireless devices” has been updated (p. 68).</li> </ul>
12/22	<ul style="list-style-type: none"> <li>• Section “Control inputs” has been updated (p. 10).</li> <li>• Section “Table of Modbus RTU protocol registers” has been updated (p. 11).</li> <li>• Information about required version of ABAX 2 Soft program has been updated (p. 18).</li> <li>• Section “Devices status” has been updated (p. 24).</li> <li>• Section “Wireless devices supported by the controller” has been updated (p. 29).</li> <li>• Section “Device settings” has been updated (p. 45).</li> <li>• Section “Programming devices using the DLOADX program” has been updated (p. 47).</li> <li>• Section “Specific character of the operation of wireless devices” has been updated (p. 55).</li> <li>• Section “Programming devices using the ABAX 2 Soft program” has been updated (p. 65).</li> <li>• Section “Specific character of the operation of wireless devices” has been updated (p. 68).</li> </ul>
03/23	<ul style="list-style-type: none"> <li>• Information about the PERFECTA 64 M control panel has been added in the “Introduction” section (p. 5).</li> <li>• Section “Selecting the controller operating mode” has been updated (p. 8).</li> <li>• Information about connecting the controller to the PERFECTA 64 M control panel has been added (p. 17).</li> <li>• Section “Keypads” has been updated (p. 30).</li> <li>• Subsection “Expander for the PERFECTA 64 M control panel” (p. 36) has been added in the “Registering devices to the controller” section.</li> <li>• Subsection “Expander for the PERFECTA 64 M control panel” (p. 57) has been added in the “Programming the ABAX 2 system” section.</li> <li>• Section “Keyfobs in the PERFECTA 64 M system” has been added (p. 73).</li> </ul>
04/23	<ul style="list-style-type: none"> <li>• Section “Table of Modbus RTU protocol registers” has been updated (p. 11).</li> <li>• Information about required version of ABAX 2 Soft program has been updated (p. 18).</li> </ul>