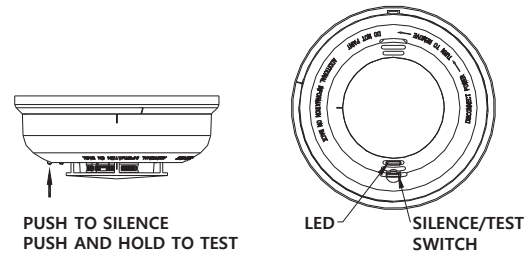

Figure 10:



Connecting Auxiliary Devices with Relay

This smoke-alarm has a built-in relay which may be used to activate auxiliary devices such as bells, horns, and door closers. The relay contacts automatically close approximately eight (8) seconds after the unit goes into alarm, and automatically resets approximately five (5) seconds after the alarm stops. For wiring refer to Figure 8. Auxiliary voltage and current requirements must be within relay contact ratings and appropriate wiring must be used.

How to Interconnect Smoke-alarms

NOTE: Interconnect smoke-alarms within one residential unit only. If smoke-alarms are interconnected between residential units, nuisance alarms will occur when a smoke-alarm in another residence is tested. The model 2012/24AUSI has two interconnection modes which are shown in table 1.

TABLE 1: INTERCONNECTION MODES

| Interconnection Mode | Interconnected Terminals | Electronic Horn | Relay |
|----------------------|--------------------------|-----------------|--|
| SIGSND | SIGSND and GND | Sound | Only the smoke-alarms in local alarm are activated |
| SIGRLY | SIGRLY and GND | Sound | All the interconnected smoke-alarms are activated |

- Up to twenty-four 2012/24AUSI smoke-alarms may be interconnected. **The 2012/24AUSI smoke alarms may also be interconnected with 2012/24AUS at all specified supply voltage and 2012H(A) at 12VDC supply voltage.** If one smoke-alarm senses smoke, all of the interconnected units will sound in SIGSND mode, the relays of the interconnected units will be activated approximately eight seconds after horns sound in SIGRLY mode. After interconnecting the smoke-alarms, push and hold the test switch for more than 3 seconds on one unit. The alarm horns on all of the other smoke-alarms should sound if they are connected correctly.
- If any interconnected smoke-alarm is activated by another unit, it senses smoke, the unit will go into local alarm state with the red LED flashing quickly.
- Connect the smoke-alarms together by interconnecting all the SIGSND terminals to each other and all GND terminals to each other in SIGSND mode, and interconnecting all the SIGRLY and GND terminals to each other in SIGRLY mode. (See Figure 7.) Use 0.75mm or larger two-conductor standard wire.
- If smoke-alarms will not be connected. DO NOT use the SIGSND, SIGRLY and GND terminals.
- The green LEDs on all smoke-alarms should be lit when external power is turned on to the smoke-alarms. Test smoke-alarms after interconnection wiring are complete.

Cautionary Note: Test interconnection wiring after installation is completed. Test each unit in a system and make sure all other units alarm. FAILURE TO OBSERVE ANY OF THESE CONDITIONS CAN CAUSE SYSTEM MALFUNCTION AND/OR DAMAGE TO THE SMOKE-ALARMS.

Testing Information

- You should test your smoke-alarm at least once a week to assure yourself of its operation, as recommended by AS3786:2014. Test the smoke-alarm by firmly depressing the test switch located on the smoke-alarm cover (marked "Push and Hold to Test") FOR 3 SECONDS. (See Figure 10). The alarm horn should sound, and the red LED should flash rapidly. When the test switch is pushed and held for more than 8 seconds, the relay will be activated.
- In an interconnected system, all of the smoke-alarms should sound their alarm horns when any one of the test switches is pushed. The alarm horn sounds if the smoke-alarm is working properly. **This is the only way to be sure the smoke-alarm is working. Test the smoke-alarm weekly. If the smoke-alarm fails to test properly, have it repaired or replaced immediately.**

- DANGER:** If the alarm horn sounds a smoke-alarm and you are not testing the unit, the smoke-alarm has sensed smoke or combustion particles in the air. THE ALARM HORN IS A WARNING OF A POSSIBLY SERIOUS SITUATION. IT REQUIRES YOUR IMMEDIATE ATTENTION.
- The alarm could be caused by a nuisance situation. Cooking smoke or a dusty furnace can cause the smoke-alarm to sound. If this happens, open a window or fan the air to remove the smoke or dust. The smoke-alarm will turn itself off as soon as the air is completely clear. DO NOT TURN OFF POWER TO THE SMOKE-ALARM. THIS WILL REMOVE YOUR PROTECTION.

Monitoring Your Smoke-alarm

Once the smoke-alarm is powered by external power, a green LED lit. This signals that the smoke-alarm is receiving power and is in the detection mode. When the smoke-alarm senses smoke, the green LED OFF and red LED flash rapidly. See chart below for specific LED functions.

TABLE 2: SMOKE-ALARM STATUS

| Smoke-alarm Status | Electronic Horn | Bi-color LED | Relay |
|------------------------|---------------------------------|---------------------------------------|------------------------|
| Normal Standby | Silent | Green LED lit while external power on | Open |
| Silence State | Beeps three times every 40 secs | Green LED lit while external power on | Open |
| Local Alarm | Temporal Tone | Red LED Flash rapidly | Closed after 8 seconds |
| SIGSND Signal Received | Temporal Tone | Green LED lit while external power on | Open |
| SIGRLY Signal Received | Temporal Tone | Green LED lit while external power on | Closed after 8 seconds |
| Failed chamber test | Beeps twice every 40 secs | Green LED lit while external power on | Open |
| Low battery voltage | Beeps once every 40 secs | Green LED lit while external power on | Open |

The smoke-alarm will automatically return from Alarm to Normal state when the reason for alarm, as the presence of smoke, is completely removed.

Cleaning and Maintenance

DANGER: Electrical Shock Hazard. Turn off power to the smoke-alarm at the main service panel before cleaning the smoke-alarm.

This smoke-alarm has been designed to be as maintenance-free as possible. However, regular testing (see "Testing" above) and periodic maintenance are necessary.

To clean the smoke-alarm, turn off power and vacuum the outside of the smoke-alarm with the soft brush attachment of a vacuum cleaner. Do this at least once every year, preferably every six months. **DO NOT ATTEMPT TO CLEAN THE SMOKE-ALARM IN ANY OTHER WAY.**

If the smoke-alarm requires service, do not attempt to service it yourself; this will void your warranty. Return the smoke-alarm to your local System Sensor distributor or agent. Enclose a note describing what is wrong with the smoke alarm.

Special Note Regarding Smoke-alarm Protective Guards

Smoke-alarms are not to be used with protective guards or cages unless the combination has been evaluated by an accredited testing laboratory and found to be suitable for that purpose.

Warning: The disused battery must be disposed of in a careful and safe manner to avoid potential danger.

Note: Please dispose electronic waste following national or local regulations after being scrapped or replaced. Do not discard.

CAUTION: Dust covers provide limited protection against airborne dust particles during shipping. Dust covers must be removed before the detectors can sense smoke. Remove detectors prior to heavy remodeling or construction.

www.systemsensor.com

Please refer to insert for the Limitations of fire alarm systems

INSTALLATION AND MAINTENANCE INSTRUCTIONS

2012/24AUSI Photoelectric Smoke-alarm with Integral Temp-3 Sounder

Specifications

| | |
|-------------------------------|--|
| Supply Voltage Range: | 10VDC ~ 30VDC |
| Max. Average Standby Current: | 6mA @ 24VDC external power and 9VDC back-up battery 9uA @ only 9VDC back-up battery |
| Max. Average Alarm Current: | 30mA @ 24VDC external power and 9VDC back-up battery 50mA @ only 9VDC back-up battery |
| P-Horn Sound Output Level: | 85dB(A) at 3m |
| Max. Interconnected Units: | 24 |
| Silence Mode Timeout Period: | 8 minutes or cancel by pressing silence/test switch for more than 3 seconds |
| Relay Contact Ratings: | 1Amp@30VDC/30VAC |
| Height: | 55mm |
| Diameter: | 135mm |
| Weight: | 236g |
| Operating Temperature Range: | 0°C to 45°C |
| Humidity: | 5% to 93% R.H. |

General Description

Smoke-alarms are designed to provide early warning of developing fires at a reasonable cost. They monitor the air and can sense smoke, providing precious minutes for occupants to escape before a fire spreads. Early warning fire detection is best achieved by the installation of smoke alarms in all rooms and areas of the building.

Model 2012/24AUSI is a photoelectric smoke-alarm designed for open area protection for both residential and commercial applications. It has a built-in relay which may be used to activate auxiliary devices such as bells, horns, and door closers. The relay contacts automatically close 8 seconds after the smoke-alarm goes into alarm, and automatically resets approximately 5 seconds after the alarm stops. A piezoelectric horn in each smoke-alarm produces an audible 85dB(A) temporal tone evacuation signal when a unit alarms or an interconnected one alarms. This temporal tone evacuation signal complies with AS3786:2014. The signal consists of 3 beeps each 0.5 seconds long, spaced 0.5 seconds apart, followed by 1.5 seconds of silence. The horn will beep every 40 seconds as the battery voltage is lower than about 8.2V. These smoke-alarms can be interconnected with the SIGSND and GND terminals for a system of up to 24 smoke-alarms per premises so when one smoke-alarm sounds its evacuation signal it causes the other connected smoke-alarms to sound as well. They also can be interconnected with the SIGRLY and GND terminals, when any one alarms, all the interconnected units' relays will be activated approximately 8 seconds after horns sound. Model 2012/24AUSI has a backup battery in case of main power failures. The smoke-alarm has a built-in silence/test push switch to silence or test. If the silence/test switch is pushed for less than 3 seconds, this is a silence instruction, the smoke-alarm will stop alarm and the horn will beep three times every 40 secs for about 8 minutes. If the silence/test switch is pushed and held for more than 3 seconds, this is a test instruction and will also cancel the silence mode (See "Testing" below for more detailed instructions.)

Smoke-alarm Power Requirements

Power input rating to the smoke-alarm is 12/24VDC@0.05 amp. Power supply and smoke-alarm installation must conform to the electrical codes in your area. It is recommended that wiring be performed by a qualified installer.

Installation in Australia

The installation temperature range for Australia is 0°C to 45°C and has been tested per the Australian Standard. Smoke-alarms should be installed by qualified technicians.

Smoke-alarm Limitations

- This smoke-alarm is self-resetting and does not latch into an alarm condition.
- Smoke-alarms will not sense a fire if the smoke does not reach the sensor. In order for a smoke-alarm to sense smoke, it must be installed in the immediate vicinity of the fire. In addition, smoke from fires in chimneys, in walls, on roofs, in remote parts of the building, or on another level from where the smoke-alarm is located, may not reach the smoke-alarm quickly enough for occupants to escape unharmed. For this reason, the installer shall install smoke-alarms on every level, in every sleeping area, and in every bedroom of the building.
- Smoke-alarms may not be heard. The alarm horn in this smoke-alarm meets or exceeds current Australian standards. However, if the smoke-alarm is not located in the same room as the occupant, or if it is blocked by a closed door or normal noise, the alarm horn may not be heard. In addition, sound sleepers, or persons who are under the influence of drugs or alcohol may not hear the alarm or be able to react to it. Therefore, locate this smoke-alarm, which has a sounder rated at 85dB(A) at 3 meters, on every level, in every sleeping area, and in every bedroom of the household.



28 Tuan Jie South Road, Xi'an National Hi-tech Industrial Development Zone Province of Shaanxi, 710075, China

156-6410-000

- In general, smoke-alarms may not always warn you about fires caused by carelessness and safety hazards like smoking in bed, violent explosions, escaping gas, improper storage of flammable materials, overloaded electrical circuits, children playing with matches, or arson.
- Smoke-alarms are not fool-proof. Like all electronic devices, smoke-alarms have limitations. No type of smoke-alarm can sense every kind of fire every time.
- Smoke-alarms are not a substitute for life or property insurance. Though smoke-alarms have been responsible for saving many lives, they are not warranted or implied to protect lives or property in the event of a fire.
- A preventative maintenance agreement should be arranged through the local manufacturer's representative. Though smoke-alarms are designed for long life, they may fail at any time. Therefore, smoke-alarms shall be replaced after being in service for 10 years. Any smoke-alarm, fire alarm equipment, or any component of that system which fails shall be repaired or replaced as soon as possible.

Where to Install Smoke-alarms

Warning: As a minimum requirement, smoke-alarms must be installed in accordance with the requirements of AS3786:2014.

Proper Smoke-alarm Location:

Figure 1: Recommended smoke-alarm protection for single-floor residence with only one sleeping area:

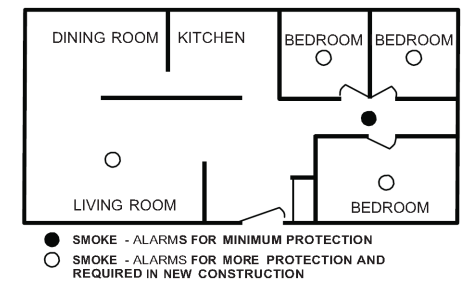
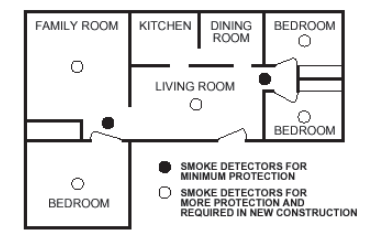

Figure 2: Recommended smoke-alarm protection for single-floor residence with more than one sleeping area:



Smoke-alarms shall be installed outside of each separate sleeping area in the immediate vicinity of the bedrooms and on each additional story of the family living unit, including basements and excluding crawl spaces and unfinished attics. In new construction, a smoke-alarm also shall be installed in each sleeping room.

For better protection, we recommend the installation of a smoke-alarm inside every bedroom in existing construction.

- Install a minimum of two smoke-alarms in any household, no matter how small it is. Put a smoke-alarm in the hallway outside of every separate bedroom area. (See Figure 1.) A minimum of two smoke-alarms are required in homes with two bedroom areas. (See Figure 2.)
- Put a smoke-alarm on every level of a multi-level residence (See Figure 3.)
- Install basement smoke-alarms on the ceiling at the bottom of the basement stairwell. (See Figure 3.)

Figure 3: Recommended smoke-alarm protection for a multi-level residence:

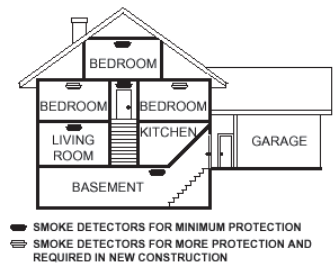

- Install smoke-alarms on the ceiling as close to the center of the room as possible. If this is not practical, install it on the ceiling no closer than 10cm from any wall or corner. (See Figure 4.)

Figure 4: Recommended smoke-alarm mounting locations:

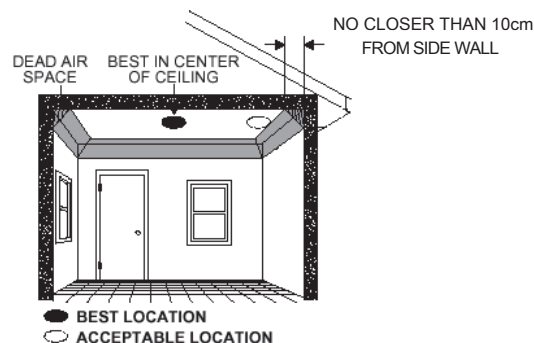

- Put smoke-alarms at both ends of a bedroom hallway if the hallway is more than 9 meters long. In addition, large rooms will require more than a single smoke-alarm if the room is over 84 square meter.
 - Rooms or areas that do not have smooth ceilings, or which have short, transom-type walls coming down from the ceiling require additional smoke-alarms.
 - Install second-floor smoke-alarms on the ceiling at the top of the first-to-second floor stairwell. Be sure no door or other obstruction blocks the path of smoke to the smoke-alarm.
- In rooms with sloped, peaked, or gabled ceilings, install smoke-alarms 0.9 meter measured down on the slant from the highest point of the ceiling. See Figure 5.

Figure 5: Recommended smoke-alarm location in rooms with sloped, gabled or peaked ceilings:

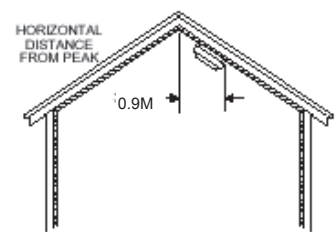

Where Smoke-alarms Should NOT Be Installed

- In or near areas where combustion particles are normally present such as kitchens; in garages where there are particles of combustion in vehicle exhausts; near furnaces, hot water heaters, or gas space heaters. Install smoke-alarms at least 6 meters away from kitchens and other areas where combustion particles are normally present.
- On the ceiling in rooms next to kitchens where there is no transom between the kitchen and these rooms. Instead, install the smoke-alarm furthest from the kitchen (See Figure 6). Be sure not to install smoke-alarms within 10cm of the ceiling.

Figure 6: Recommended smoke-alarm locations to avoid air streams with combustion particles:

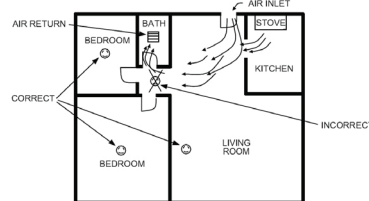

- In damp or very humid areas, or next to bathrooms with showers. The moisture in humid air can enter the sensing chamber as water vapor, then cool and condense into droplets that cause a nuisance alarm. Install smoke-alarms at least 1.5 meters away from bath-rooms.
- In very cold or very hot rooms or areas. Operating temperature of the smoke-alarm is 0°C to 45°C.
- In dusty, dirty, or insect-infested areas. Dust and dirt can build up on the smoke-alarm's sensing chamber and make it overly sensitive, or can block openings to the sensing chamber and keep the smoke-alarm from sensing smoke.
- Near fresh air inlets or returns or excessively drafty areas. Air conditioners, heaters, fans, and fresh air intakes and returns can drive smoke away from smoke-alarms, making the units less effective.
- In dead air spaces at the top of a peaked ceiling or wall/ceiling inter sect. Dead air may prevent smoke from reaching a smoke-alarm.
- Near fluorescent light fixtures. Install smoke-alarms at least 3 meters away from such light fixtures.

Installation Requirements

Warning: Electrical Shock Hazard. Turn off power at the main fuse box or circuit breaker to the area of smoke-alarm installation before beginning installation procedures.

- Mount smoke-alarm to a 10cm octagonal junction box only. Mount the 12/24 Volt D.C. power supply to a 10cm square junction box 5cm deep only. (If necessary, add an extension ring if the selected box does not have adequate volume.) The power supply may be mounted remotely from the smoke-alarm.
- All wiring must be performed by a licensed electrician.
- Use only the specified wire gauge.
- The smoke-alarm includes a tamper-resist feature that, when activated, requires a tool for smoke-alarm removal. The following smoke-alarm installation instructions include how to activate this feature.

Installation Instructions

1. Turn off power at main service panel.
 2. Using wire connectors, connect power supply output wires to the bus line wires supplying power to the remote smoke-alarms. (See Figure 7.) Use color-coded bus wires.
 3. Mount power supply to junction box and cover junction box with a 10cm square box cover, using box mounting screws.
 4. Install a junction box where you plan to install the smoke-alarm. (See type and size for junction box above.)
 5. Install bus line wires from power supply output to junction box. Use 0.75 to 1.5mm wire only. See Figure 7 to determine maximum power bus length for wire size and number of interconnected smoke-alarms.
 6. Connect color-coded DC power bus wires to power input screw terminals, located on smoke-alarm back. If smoke-alarms will be interconnected or the relay used, see following sections for specific installation instructions.
 7. Remove smoke-alarm from mounting bracket by turning the smoke-alarm counterclockwise and pulling the smoke-alarm away from the bracket.
 8. Remove small tab on mounting bracket to activate tamper-resist feature, if desired. (To release a smoke-alarm with this feature, push up on locking tab with screwdriver while turning smoke-alarm counterclockwise.)
 9. Install mounting bracket to junction box.
 10. Connect power wires to the smoke-alarm(s) as shown in Figure 8. Be sure to tighten each terminal screw to secure wire in place. Tug wire to be sure it is connected properly.
 11. Battery installation instruction: Turn the red knob counterclockwise (See Figure 9) and open the cover of the battery box on the base. Then take the battery button out of the box carefully. Push and hold the silence/test switch more than 5 seconds to discharge the smoke alarm. Fasten the battery into the socket. Insert the battery into the box. If the battery is installed correctly, test the battery connection by pushing and holding the silence/test switch more than 3 seconds, the alarm horn should sound and the red LED should flash rapidly. Lock the battery cover by turning the red knob clockwise (See Figure 9).
- NOTE:**
- Only the allowed battery model can be used.
 - Recommended periodic battery replacement interval: 4 years

Figure 7:

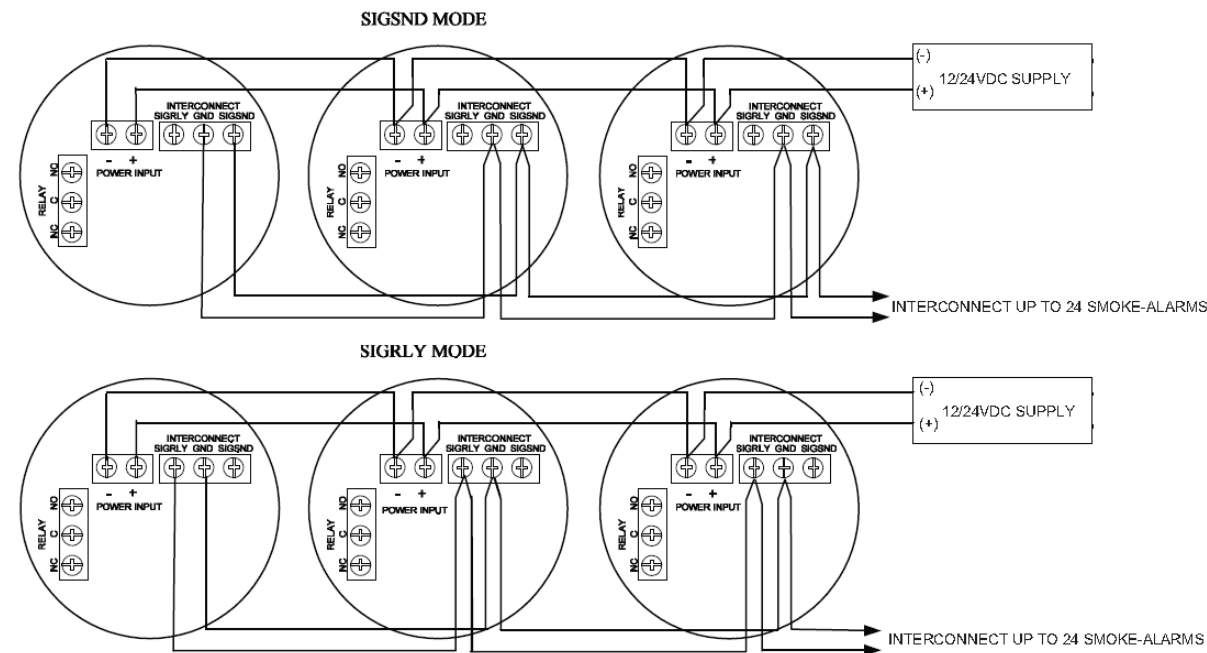

Maximum power bus length in meters, given number of units (maximum per bus) and wire size (mm²). Supply Voltage = 12VDC

| WIRE SIZE(mm ²) | 1 UNIT | 2 UNITS | 3 UNITS | 4 UNITS | 5 UNITS | 6 UNITS | 7 UNITS | 8 UNITS | 9 UNITS | 10 UNITS | 11 UNITS | 12 UNITS |
|-----------------------------|--------|---------|---------|---------|---------|---------|---------|---------|---------|----------|----------|----------|
| 1.5 | 3302 | 1652 | 1101 | 826 | 660 | 551 | 471 | 413 | 366 | 331 | 301 | 275 |
| 1.0 | 1633 | 817 | 544 | 408 | 327 | 273 | 233 | 205 | 182 | 163 | 149 | 135 |
| 0.75 | 819 | 411 | 273 | 205 | 163 | 138 | 117 | 103 | 91 | 82 | 75 | 68 |

| WIRE SIZE(mm ²) | 13 UNITS | 14 UNITS | 15 UNITS | 16 UNITS | 17 UNITS | 18 UNITS | 19 UNITS | 20 UNITS | 21 UNITS | 22 UNITS | 23 UNITS | 24 UNITS |
|-----------------------------|----------|----------|----------|----------|----------|----------|----------|----------|----------|----------|----------|----------|
| 1.5 | 254 | 236 | 220 | 206 | 194 | 183 | 174 | 165 | 157 | 150 | 144 | 138 |
| 1.0 | 126 | 117 | 109 | 102 | 96 | 91 | 86 | 82 | 78 | 74 | 71 | 68 |
| 0.75 | 63 | 59 | 55 | 51 | 48 | 46 | 43 | 41 | 39 | 37 | 36 | 34 |

For 24VDC supply voltage, the maximum power bus length is 4 times as long as 12VDC supply voltage. Maximum interconnect bus length: 2000 meters, 0.75 mm² or larger cable. All wiring must conform to local electrical codes.

Figure 8:

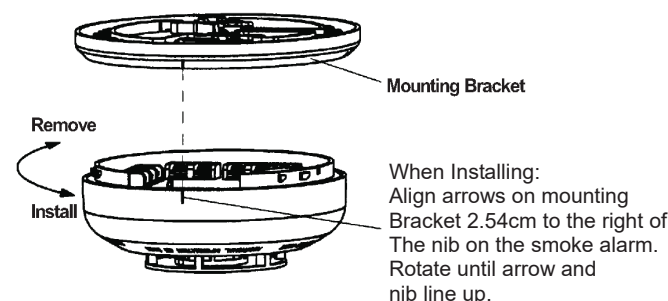

- The battery box cover will be held up by the spring slice and can not be closed if the battery is not installed.
 - The 9V back-up battery can be replaced by a 9V Alkaline battery from brand such as HENGWEI, Duracell or Energizer. These can be purchased from most major retail outlets throughout Australia & New Zealand such as Bunnings, Officeworks, Office max and Jay car.
12. Attach the smoke-alarm to mounting bracket by aligning arrows on side of mounting bracket 2.54cm to the right of the nib on the unit. Rotate until the arrow and nib line up. (See Figure 8).
 13. After installing all smoke-alarms, turn on power at the main service panel.
 14. Check the state of LED. If the green LED lit, this means the smoke-alarm is receiving external power. Check all smoke-alarms. Note: If the green LED does not light up, external power is not getting to the smoke-alarm. Check wiring. If green LED still does not light up, return the smoke-alarm to the manufacturer for repair.
 15. Test each smoke-alarm in the system. (See "Testing" below for more detailed instructions.)

How to replace the battery

1. Turn off power at main service panel.
2. Remove smoke-alarm from mounting bracket by turning the smoke-alarm counterclockwise and pulling the smoke-alarm away from the bracket.
3. Turn the red knob counterclockwise and then refer to "Installation Instructions"(from point 11 to 15)

Note:

- Before installing a new battery, please remove the old one from the smoke alarm firstly, then push and hold the silence/test switch more than 5 seconds to make sure the smoke alarm is discharged absolutely. Otherwise, it may emit the low battery voltage warning mistakenly.
- Test the smoke alarm for correct operation using the silence/test switch whenever the battery is replaced.

Figure 9:

