

SQUAREGLES®

PLAY BEYOND THE BUILD!®



GO'S SPIRAL DROP

  @squaregles | squaregles.com

All images shown are for illustration purposes only. Actual product may vary. Art in this guide is not included on panels.

SQUAREGLES®

**GO'S
SPIRAL
DROP**

GO'S SPIRAL DROP SET

Welcome to the Squaregles universe!	1
Squaregles + MESH	2
Problem Solving and Storytelling	3
Who are the Oggs?	4
Go's Spiral Drop Piece List	5
Pieces Explained	6 - 7
Let's Build!	8 - 14

EXTRA BUILD IDEAS!

Beginner	15
Intermediate	16
Combining Build Ideas! *	17

* Includes sets that are sold separately. Check out squaregles.com for additional sets.

WELCOME TO THE SQUAREGLES® UNIVERSE!

The Squaregles® universe is full of Oggs® and Erggs™, and the things they create! Oggs and Erggs are adventurous characters that spend their days pulling pranks, building crazy contraptions and losing their heads (literally!). They've got powers to discover.

Squaregles magnetically connectable frames have crazy awesome panels that pop in and out. Panels are blank and themed, flat and 3D, paperboard and plastic. Why? Every child's play style is unique, so every Squaregles build can be too. Whether you're an action seeker, contraption maker, builder, inventor, artist or storyteller, Squaregles is for you. Hello hours of fun and engagement.

On top of all the fun, playing with Oggs and Squaregles helps build Mental, Emotional and Social Health skills (MESH). Your child is able to take on new and exciting challenges, solve problems and create stories. All of these skills are proven to improve MESH.

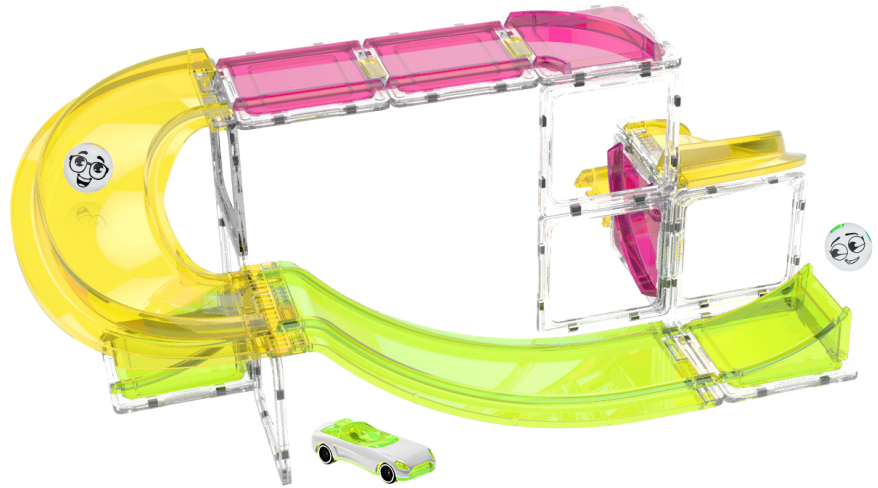

SQUAREGLES + MESH

TAKE THE PLAY EVEN FURTHER!

MESH (Mental, Emotional, Social Health) in children is important to building resiliency. There are four skills that have been identified to improve MESH through play:

1. Focus on **problem solving** and perseverance
2. Encourage **storytelling**
3. Present new or increasing challenges during the duration of play
4. Draw children and their adults to play together

Squaregles is designed specifically to develop these four MESH skills!



COMBINING PHYSICAL AND VERBAL PROBLEM SOLVING

WITH ERIKA CARDAMONE, MS, CCC-SLP

How does Squaregles do this?

- ▶ Children construct and modify their builds, as well as their stories through the characters.
- ▶ The builds can start off simple, but can become increasingly challenging as you see fit.
- ▶ Following step-by-step directions and revising construction is problem solving!
- ▶ Grownups can explain perseverance and verbally identify challenges, like "Wow, this is really tricky to balance. I wonder if we'll get it on the first try."
- ▶ Encourage storytelling! When children practice storytelling, they're doing so much more than just talking... they're verbalizing emotions, solving problems, negotiating roles, using critical thinking and language to engage with the world around them.

SIMPLE STRATEGIES TO ENGAGE IN STORYTELLING WITH YOUR CHILD:

Let your child lead the play – you are the Producer, your child is the Director of play.

The Oggs (characters) are essential for building the story. They interact through conversation, thinking, planning, and more!

Use "I wonder..." statements and open-ended questions, like "I wonder how they'll get back to shore," "How will they get rid of the shark?"

Be open to plot twists. Encourage modifications to the story and the build! For example, adding a floating dock to jump off and swim.



We partnered with Speech-Language Pathologist (and Toy Expert!), Erika Cardamone, to create ways to encourage storytelling with Squaregles. In the build section (starting on page 14), Erika has included some storytelling prompts for you to use while playing beyond the build!

WHO ARE THE OGGs®?

Oggs® are curious, sometimes sassy, always adventurous creatures. In the Squaregles universe, they uncover magical items called **Totems**!

With powerups from Totems, Oggs activate special, often surprising, and not always helpful, magical powers. How will they use them?!

Beware, the mischievous **Erggs**™ have Totems too...

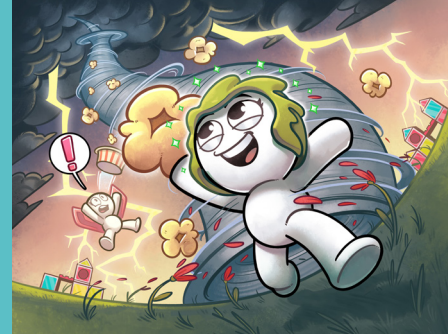

TOTEMS EXPLAINED

Along the way, Oggs uncover magical items called **Totems**. While it's a mystery where these Totems came from (or who left them behind), Oggs have discovered that Totems magically unlock powerups when equipped.

Each powerup is unique to every Ogg. For example, the Unicorn Helmet may allow Flare to teleport, but for others... well, the power may be more unpredictable. The only thing known for sure is that this is just the beginning...

Go's Spiral Drop Piece List

1
Go Head



1
Flare Head



1
Racer Helmet



1
Oggs® Car



12
Square Frames

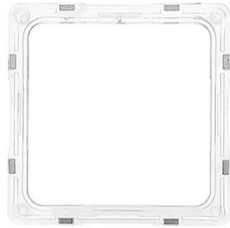

4 Edge Frames



1 Double Edge Clip



2
Bridge Clips



2
Straight Tracks



2
90° Turn Tracks



4
Paperboard Panels



2
180° Spiral Drops



2
Jump Tracks

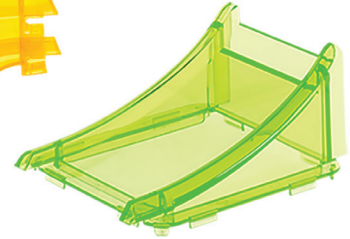

1
Mega Jump

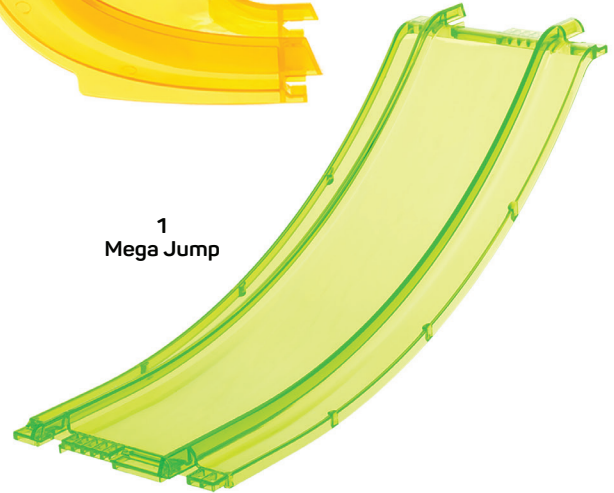

Something missing? Please reach out to us at build@squaregles.com. We're here to help!

Frames

Frames are magnetic squares.

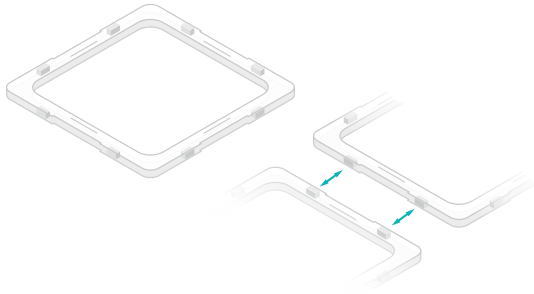

Panels

Panels come in a variety of shapes and colors and snap into frames.

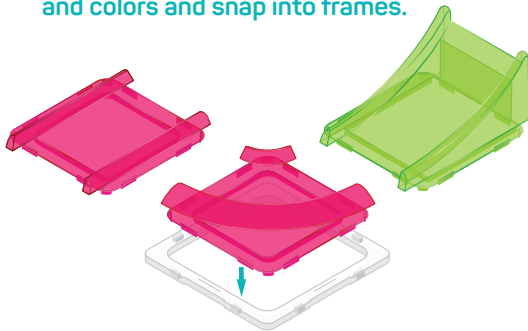

Edge Frames

Pop edge frames onto ramps and paperboard to connect them magnetically to other frames!

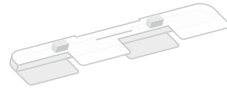

Ramps + Spiral Drops

Ramps are panels with an incline that connect to edge frames.

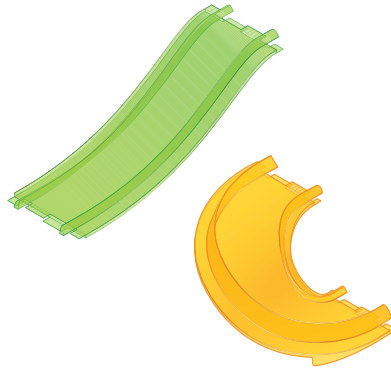

Edge Frames + Ramps

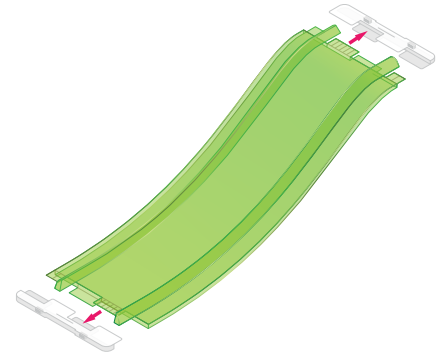

Paperboard

Paperboard are the blank paper pieces that you can draw on and snap into square and edge frames!

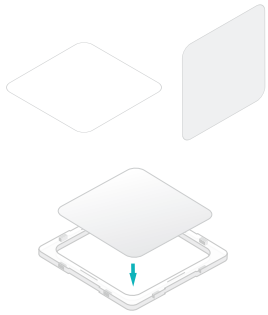

Paperboard + Edge Frame = Interactive Pieces!

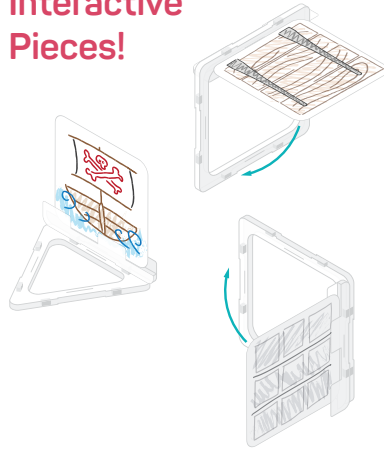

Oggs

Oggs are clever, adventurous characters included in the Squaregles Universe.

Oggs heads are balls! Roll them down ramps or attach them to their bodies for endless ways to play.

Attach Oggs' heads to their cars with their hats.

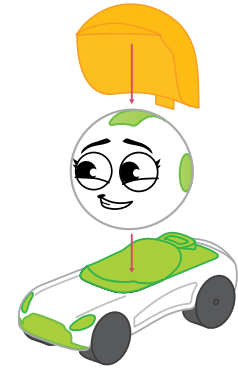

Double Edge Clip

Double edge clips connect longer ramps and tracks together.

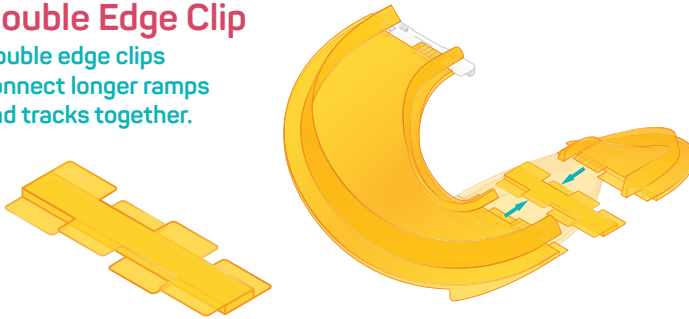

Bridge Clips

Bridge clips are our small, but mighty pieces. They reinforce magnetic connections, so you can build suspended bridges and bigger builds with fewer frames!

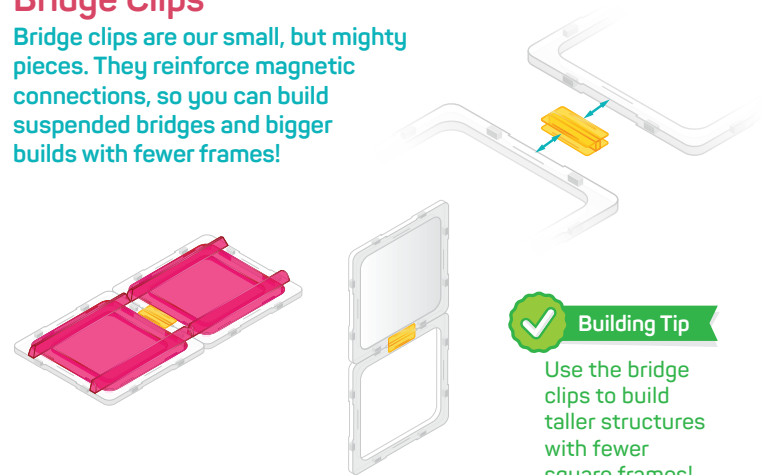

Building Tip

Use the bridge clips to build taller structures with fewer square frames!

LET'S BUILD!

Not sure where to start? Here are step-by-step instructions to recreate the build on the front of the box. **Heads up!** This may take some trial and error the first time.

Tag us on social media with [#squaregles](#). We can't wait to see the creations, contraptions and challenges you will dream up!

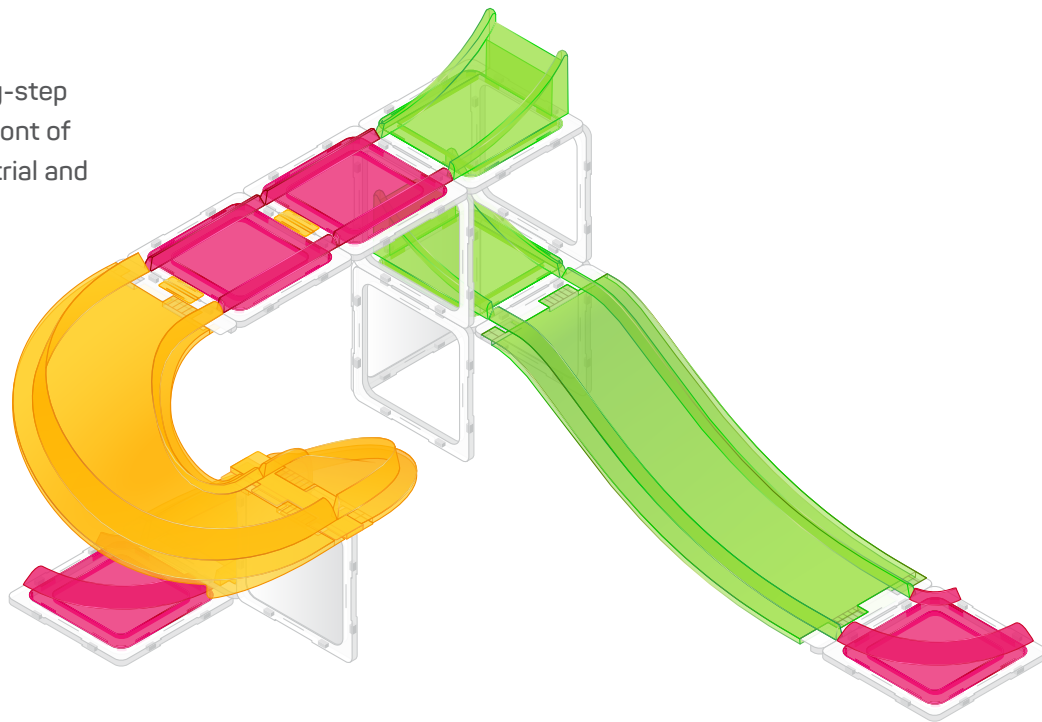

STEP

1

Snap panels into frames.

Build Tip: Less is more. You don't need 4-6 squares per level to build a tower, our magnets are strong so you can use less and maximize your build.

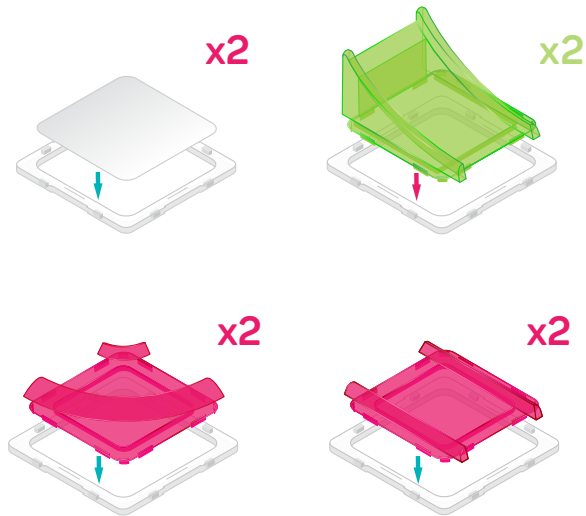

STEP

2

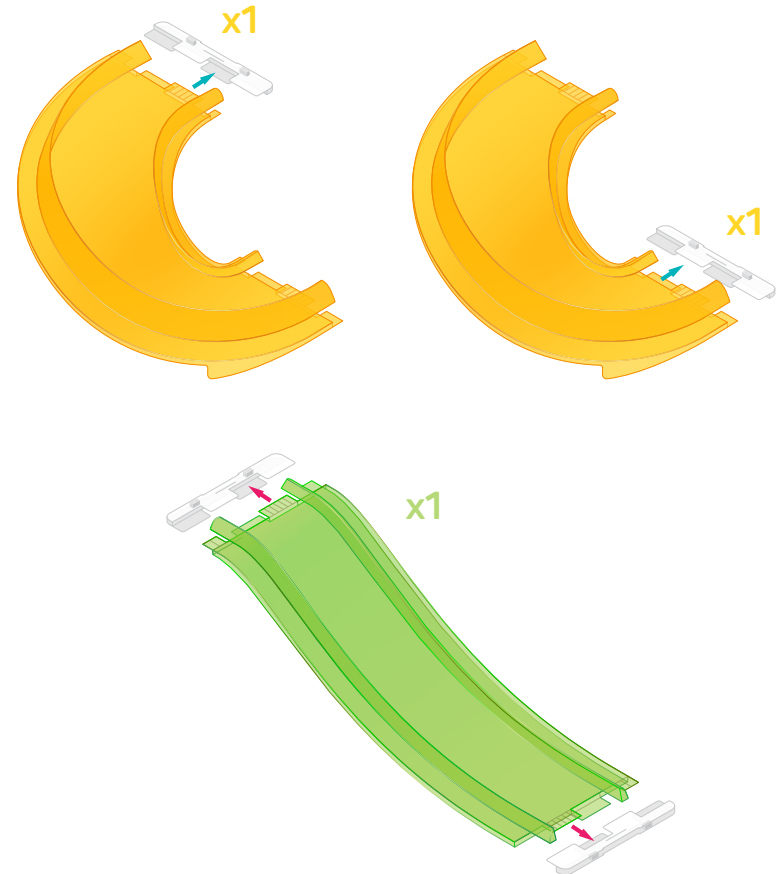
Attach edge frames to the three ramps.

STEP 3 Let's build the right tower!

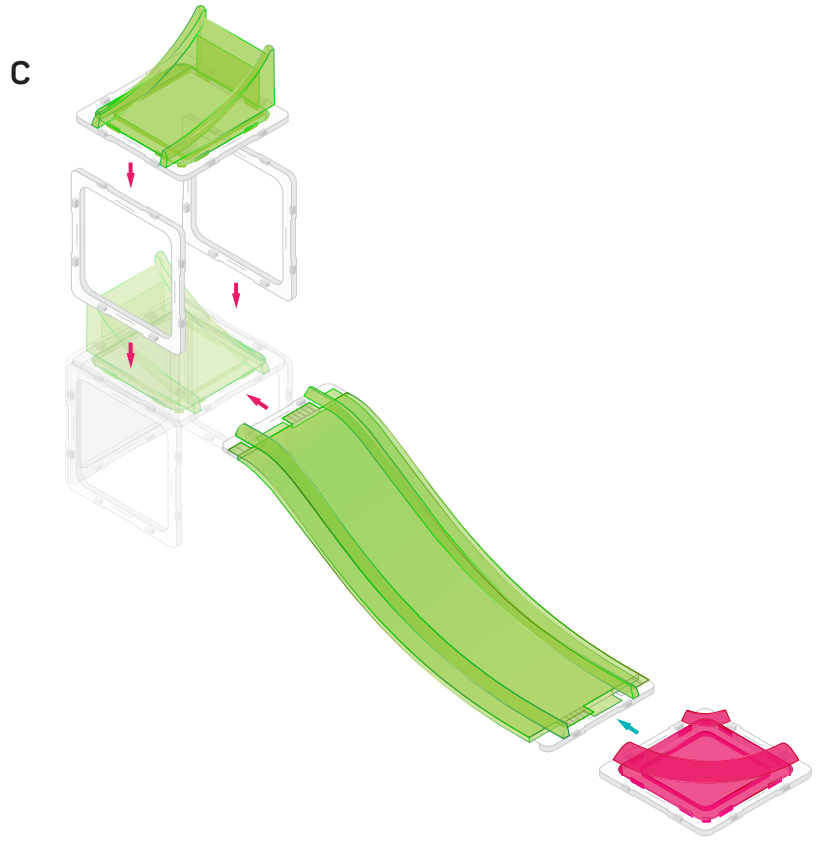
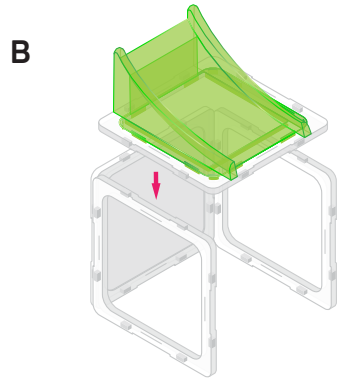
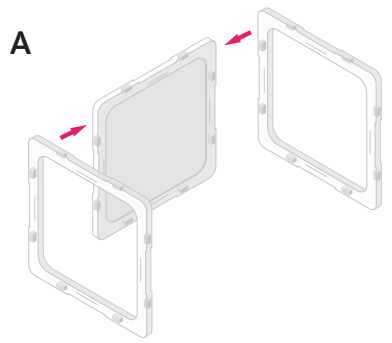

STEP

4

Let's build the 360° spiral drop and bridge.

A

Combine the two 180° spiral drops with the double edge clip.

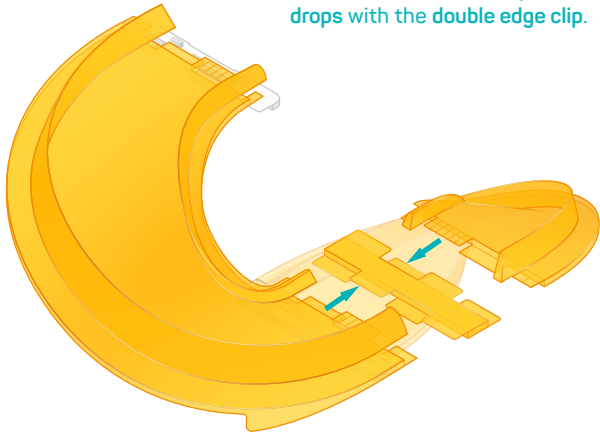

B

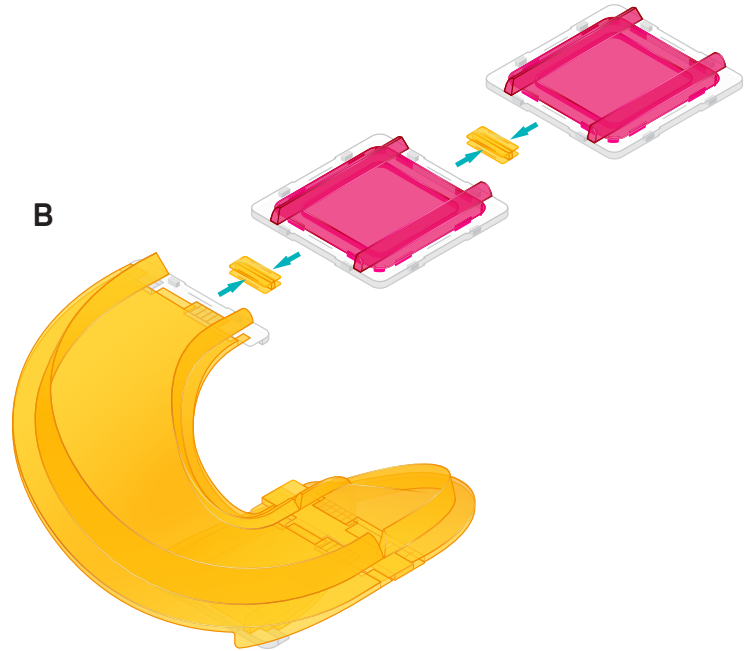

STEP 5

Let's attach the spiral drop to the tower.

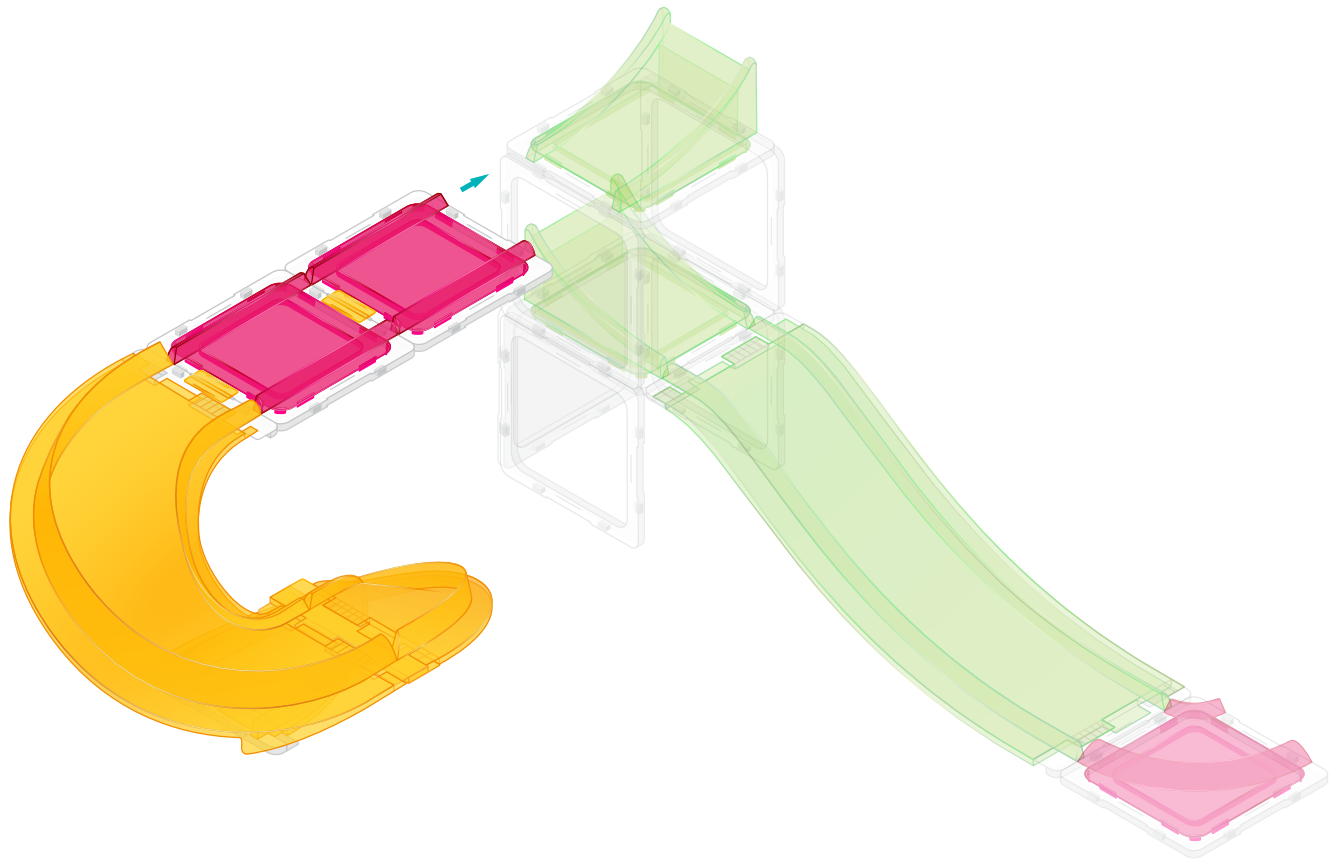

STEP

6

Let's finish the track!

Add one **frame** underneath the spiral drop for additional support. Then, add another **track piece** at the bottom of the spiral drop.

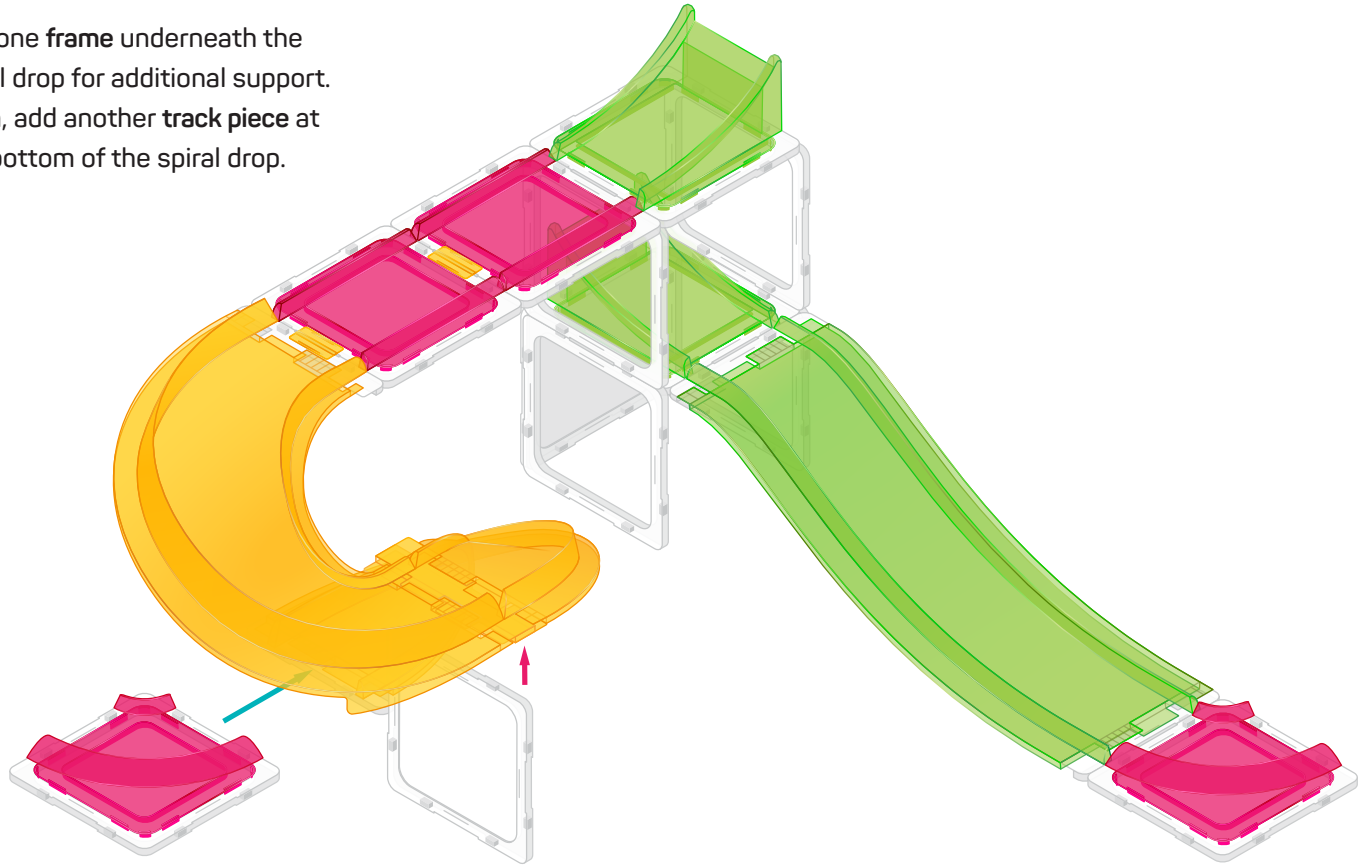

BUILD FINISHED!

STORY PROMPTS:

- ▶ Singing slides at the playground match the Oggs' mood as they slide down. What songs do they hear?
- ▶ Two Oggs are on their way to the park. One feels daring and suggests they both climb to the highest slide. Her friend is not so sure. How should she tell her friend that she's not quite ready yet?

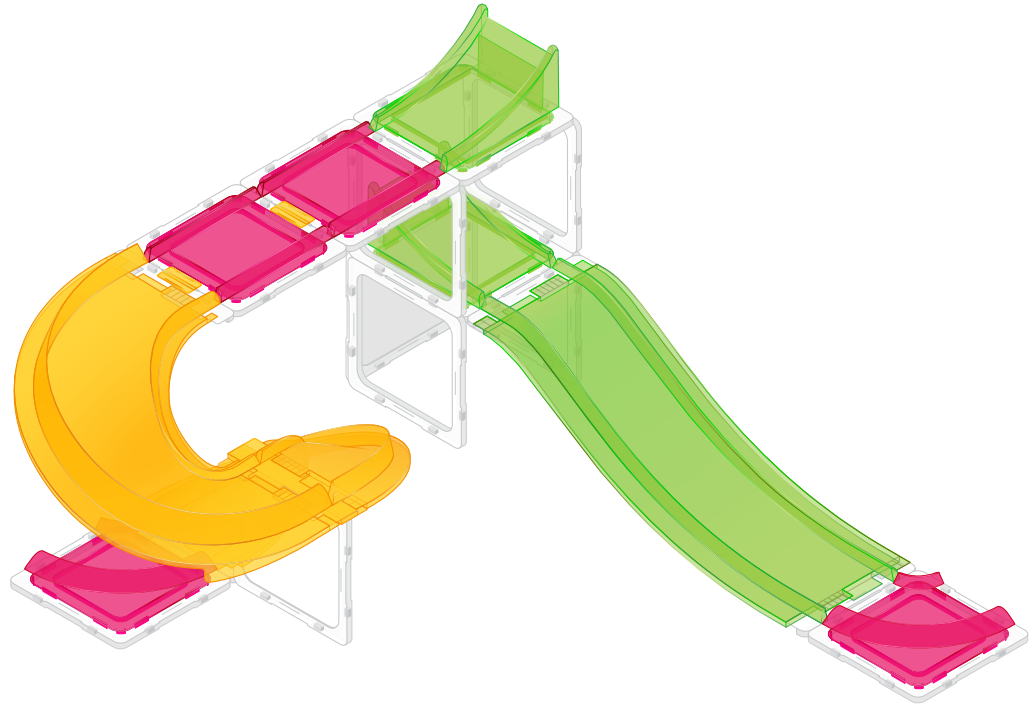

MESH PROMPT:

What sounds help your mood? Tell me about a time when you had some hard feelings (frustration, sadness, anger) and heard something that helped you.

STORY PROMPTS:

- ▶ The Oggs can't decide which way to slide. The long way or the steep way? They're quarreling over their next path. Is there more than one way to do something? Help the Oggs solve their problem.
- ▶ The Oggs create a storytelling game where they announce where they are going before going down the slide: a rapid river, icy ski run. At the bottom, they tell us what it was like. What are they saying?

MESH PROMPT:

Tell me about a time when you had to make a tough decision. Did someone help guide you to solve your problem?

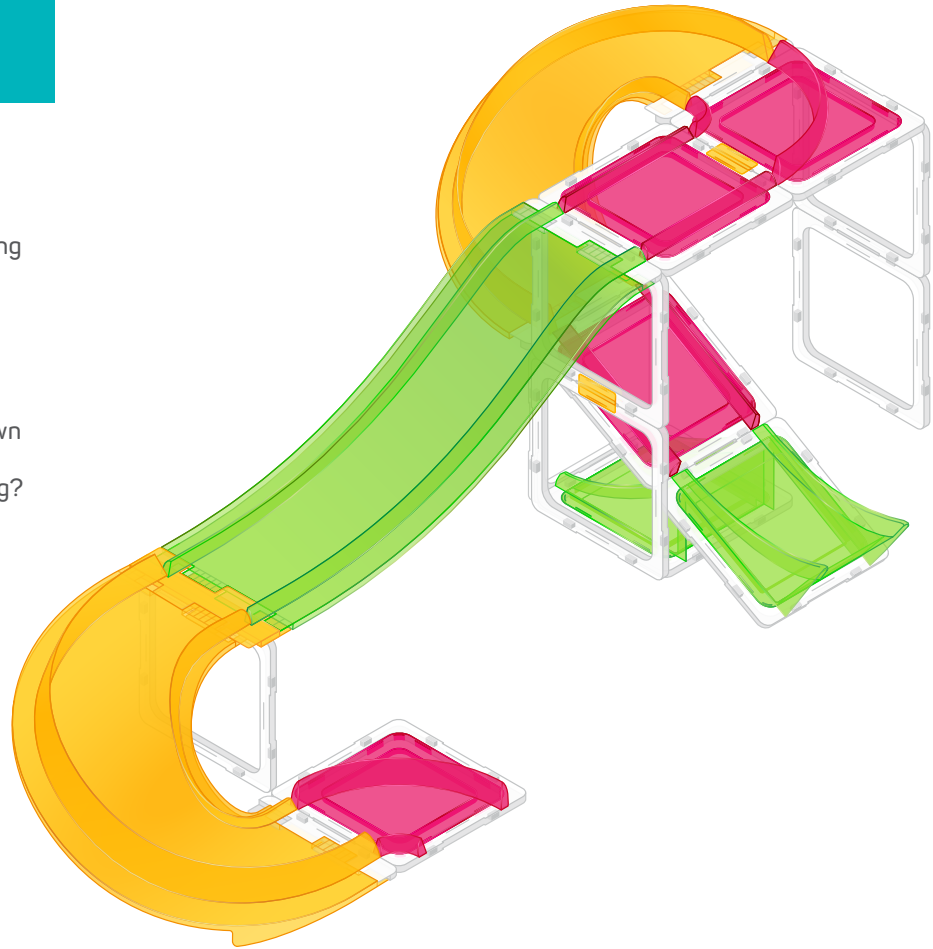

INTERMEDIATE

STORY PROMPTS:

- ▶ It's winter in the land of Oggs and they must climb to the top of the mountain to discover new territory. Now it's time to make their way back to the bottom (Sledding? Skiing? Boarding?) but it's a long way down. Encourage the Oggs that they can do it!
- ▶ The Oggs create their own water slide park. What should they add under the slide so everyone can play? A lazy river, water fountain, or skate park?

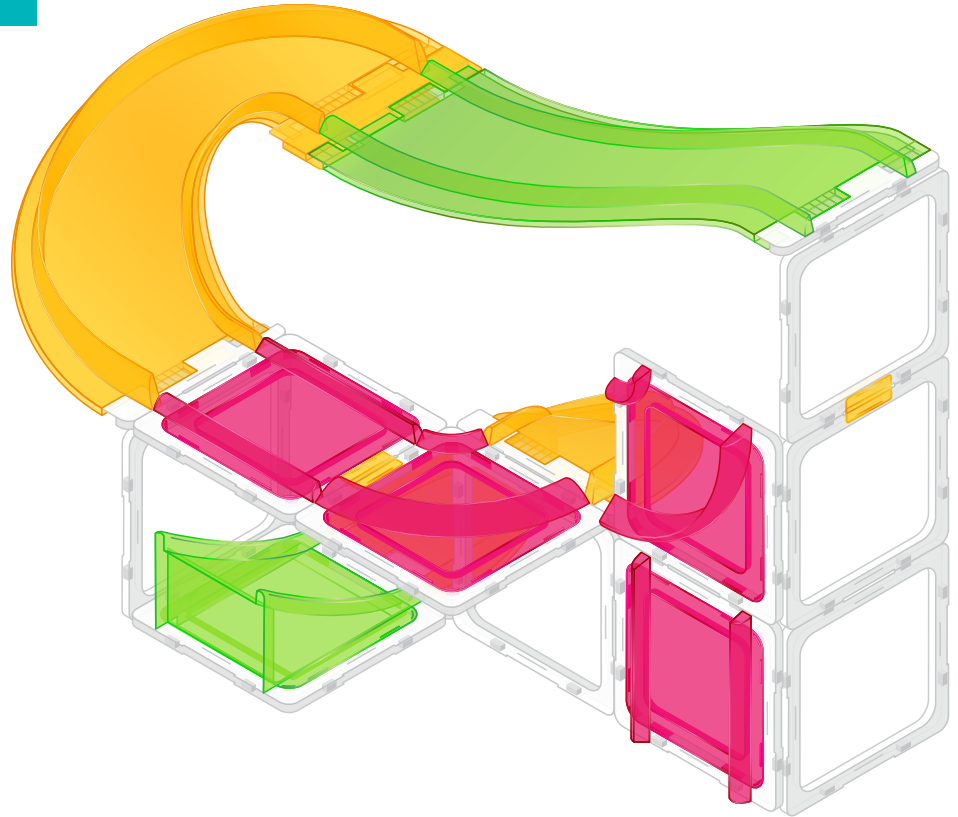

MESH PROMPT:

Who gives you encouragement when you face a challenging task?

**COMBO
BUILD
IDEA 1**

Go's Spiral Drop

+ Oggsmore Keep: A Castle Saga

(sold separately)

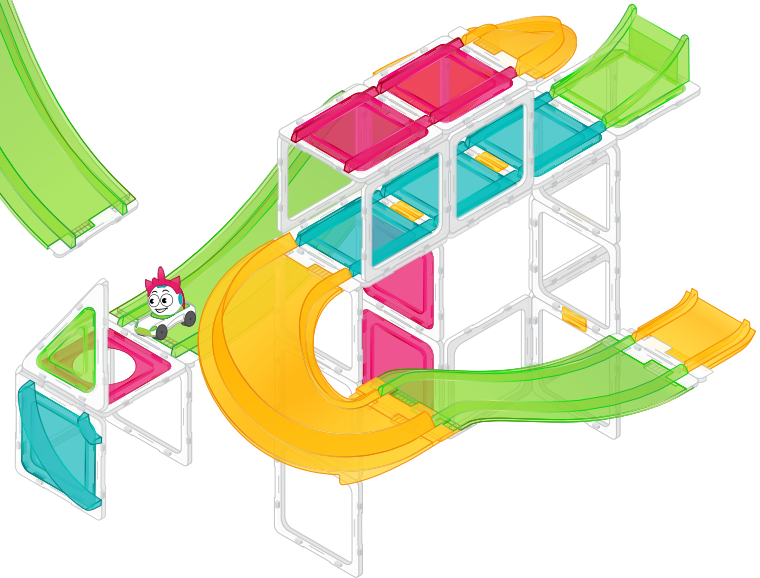
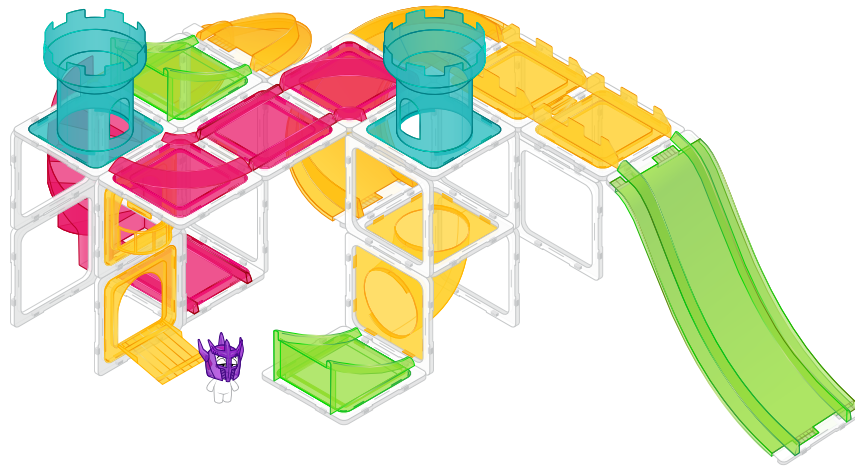

Go's Spiral Drop

+ Innovator Set

(sold separately)

**COMBO
BUILD
IDEA 2**

SQUAREGLES®

 Email: build@squaregles.com

 Instagram: [Squaregles](#)

 TikTok: [Squaregles](#)

ATTENTION!

 Do not submerge the product in water and never use washing machines or dishwashers to clean the product.

 Do not allow children to put parts in their mouth, as there may be a risk of choking. This product contains small parts and should not be used by children under 3 years old.

 If the parts break, be sure to collect all pieces and discard them immediately.

 Keep the product away from objects affected by magnets, such as credit cards, watches TVs, computers, cellphones, and other electronics.

 Please wipe with a dry towel if the product becomes dirty.

2023 Squaregles LLC. All Rights Reserved.
Squaregles, Squaregles logo, Oggs, Oggs logo, Erggs, Erggs logo, Get Lost in Play!, Play beyond the Build, Build Outside the Box, and associated trademarks and trade dress are owned by Squaregles LLC. Squaregles patent information is available at squaregles.com/patents