



PureHEPA+
WITH ODOGard®

OWNER'S MANUAL



Table of Contents

Important Safety Information	3
Diagrams	4
Initial Setup	5
Controls	6
Operation	7
Cleaning & Maintenance	8
Part Replacement	9-10
Specifications	11
Warranty Information	11

What's Included?

- PureHEPA+ Unit
- Owner's Manual

Important Safety Information



NOTE: Read this manual and all important safety instructions before using the unit.



Do not operate this unit unless it is completely assembled.



Do not block the ventilation filter.



Do not directly view UV lights while in operation.



Unplug unit before any cleaning or maintenance.



This unit is not intended for outdoor use.



Diagrams

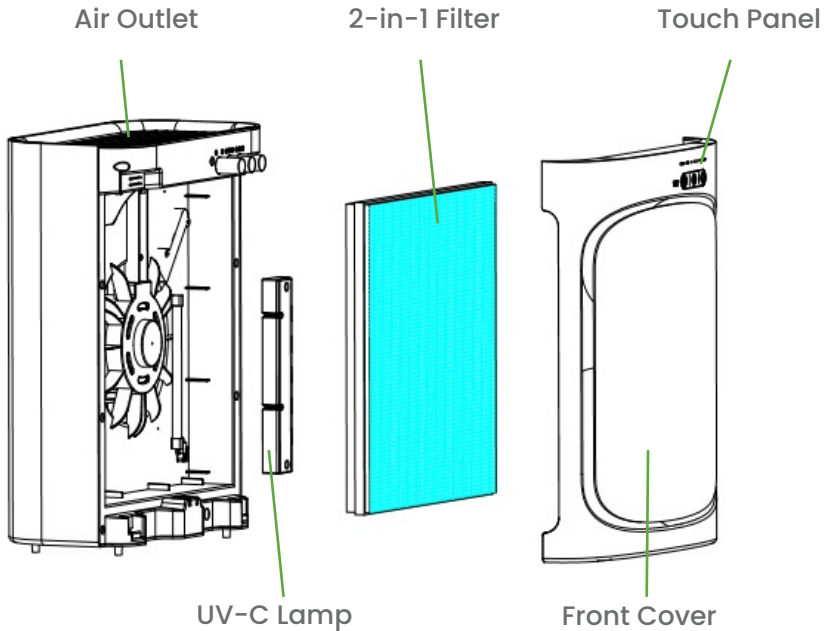



- Remove your unit from the packaging. (Keep your bag and included materials)
- Open the unit and take the filter out of the protective wrap and place the filter back into the unit before operation.
- Locate a suitable location to place your unit. (Ideal location is an area of the room with good circulation, away from the wall and your air return, or near the source of pollution)
- Plug your unit into the outlet.
- Begin purification!



Controls Diagram

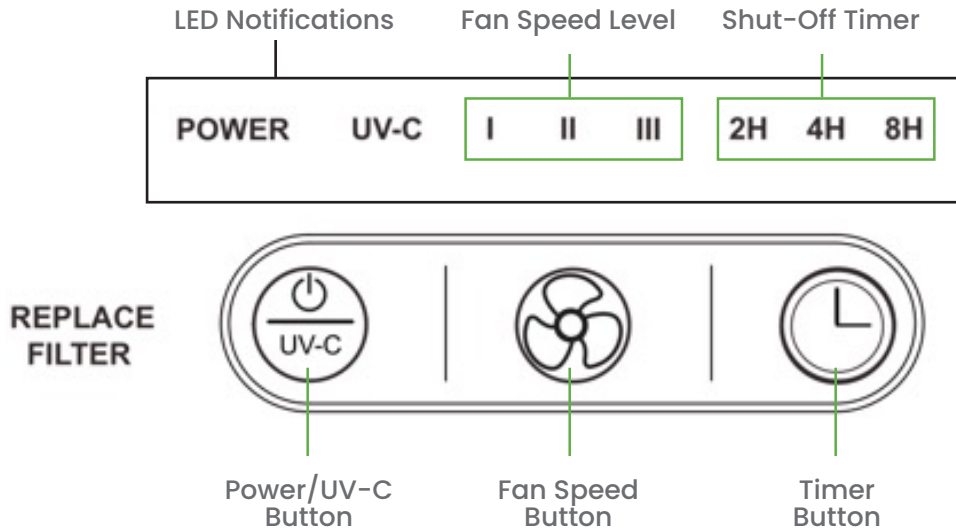



NOTE: Read this manual and all important safety instructions before using the unit.



Unit Power

Press the Power/UV-C Button to turn the unit ON or OFF.



Fan Speed

Press the Fan Speed Button to cycle through the 3 fan speeds (Low, Medium, High).



Timer

Press the Timer Button to operate the unit for 2, 4, or 8 hours. The unit will turn OFF once your chosen time has elapsed.



Cleaning & Maintenance



WARNING: UNPLUG UNIT BEFORE CLEANING OR MAINTENANCE

Cleaning

For proper operation, the unit/pre-filter should be cleaned once a month.

- **Unit Exterior** – Wipe down with damp cloth
- **Pre Filter** – Vacuum or Wash/Dry
- **Unit Interior** – Remove cover and filter and wipe interior of unit with damp cloth or vacuum and then return filter and replace parts (Annually or Biannually)

Maintenance

If your unit has stopped working properly, refer to your Warranty Information for coverage and replacement instructions.

HEPA, UV-C Bulb Component Life

Component life is determined by operating time, but is affected by the level of pollutants in the space being cleaned.

- HEPA Filter should be replaced at least every 12 months
- UV-C Bulb should be replaced every 12 months.



NOTE: Additional Filters and UV-C Bulbs can be purchased through Greentech Environmental or a Greentech Environmental retailer.

1



2



3

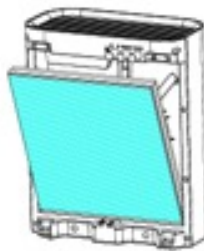

4

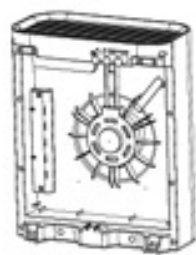

- (1) Turn the unit OFF and unplug the power cord.
- (2) Remove the Unit Cover by pulling the top edge away from the unit.
- (3) Remove Filter and Replace with new Filter. (Ensure the pull strip on the filter faces out)
- (4) Reattach the extra Pre-Filter (if removed for cleaning).
- (5) Replace the Unit Cover
- (6) Hold the Power Button for 5 seconds to reset the filter life and turn the indicator OFF.



Part Replacement – Washable Filter, UV-C Bulb



WARNING: UNPLUG UNIT BEFORE CLEANING OR MAINTENANCE

Washable Pre-Filter

- (1) Turn the unit OFF and unplug the power cord.
- (2) Remove the Unit Cover by pulling the top edge away from the unit.
- (3) Remove Pre-Filter from the HEPA Filter.
- (4) Replace with the new Pre-Filter.
- (6) Replace the Unit Cover and Power Cord.

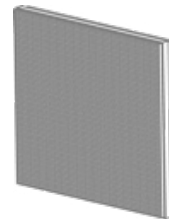

UV-C Bulb

- (1) Turn the unit OFF and unplug the power cord.
- (2) Remove the Unit Cover and Filters.
- (3) Remove the UV Lamp Cover by screwdriver.
- (4) Carefully remove the UV Bulb from the holder and disconnect the cord.
- (5) Replace with the new UV Bulb and reconnect the cord.
- (6) Replace the Filters and Unit Cover.
- (7) Replace the Power Cord.

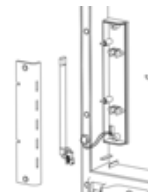
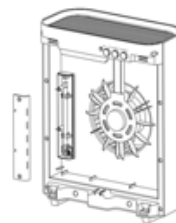

Specs & Warranty Information



- Model: 1X5825
- Unit Dimensions:10.6" * 10.6" * 17.5"
.....26.9cm * 26.9cm * 44.5cm
- Unit Weight: 11.5 lb (5.2kg)
- Electrical Input: 110V, 60Hz
- Power Consumption: 36W
- Decibel Level: 26-53dB
- Unit Warranty:1 Year

**Meets California
ozone emissions limit:
CARB certified.**



Your PureHEPA+ is warranted to be free from all defects in material and workmanship in normal household use for a period of 1 year from date of purchase. The warranty is granted only to the original purchaser and members of his or her immediate household. The warranty is subject to the following provisions: Any damages or malfunctions caused by negligence, abuse, or use not in accordance with the Owner's Manual are not covered by this warranty. Likewise, any defects or damages caused by unauthorized service are not covered. Greentech Environmental will, at its option, repair or replace a defective Air Purifier that is covered by this Warranty. As a matter of warranty policy, Greentech will not refund the customer's purchase price. To obtain warranty service you must return the defective Air Purifier along with proof of purchase to the pureAir Authorized Warranty Station. All transportation charges on parts, or units, submitted under this Warranty shall be borne by the purchaser. Unless this Warranty is expressly renewed or extended by Greentech Environmental, any repaired or replaced part of unit shall be warranted to the original purchaser only for the length of the unexpired portion of the original warranty.

Further Limitations and Exclusions Are as Follows:

Any warranty that may be implied in connection with your purchase or use of the Air Purifier, including any warranty of merchantability or any warranty for Fitness For A Particular Purpose is limited to the duration of this warranty. Some states do not allow limitations on how long an implied warranty lasts, so the above limitations may not apply to you.

Your relief for the breach of this warranty is limited to the relief expressly provided above. In no event shall Greentech be liable for any consequential or incidental damages you may incur in connection with you purchase or use of the Air Purifier. Some states do not allow the exclusion or limitation of incidental of consequential damages, so the above limitation or exclusion may not apply to you. This warranty gives you specific legal rights, and you may also have other rights which vary from state to state.

Registration

Please register your new product within 10 days of purchase by visiting greentechenv.com/warranty or scanning the QR code to take you to the site.



www.GreenTechEnv.com

OM Revision: Greentech-PureHEPA-Plus-OwnersManual-2307-v1g

Fresh Air Starts Here