

MANUAL DE MONTAGEM

ASSEMBLY INSTRUCTIONS

INSTRUCCIONES DE MONTAJE

NOTICE DE MONTAGE

MONTAGEANLEITUNG

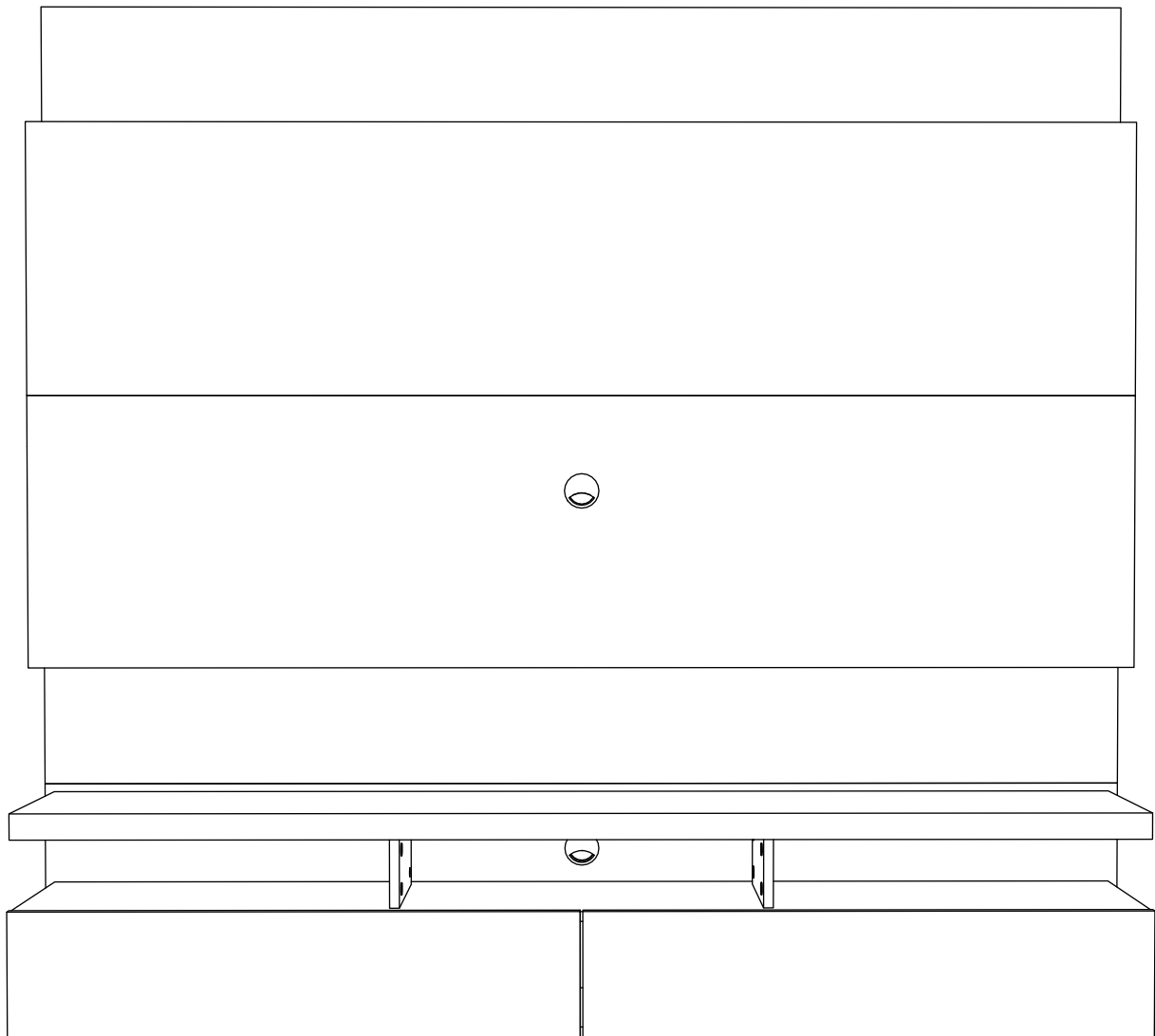

COD: 29200

REV. 04 - 20/03/20

ADESIVO-24x
 STICKER-24x
 ADHESIVO-24x
 AUTOCOLLANT-24x
 AUFKLEBER-24x

COD. 4462-4x

COD. 1669-12x

COD. 1668-22x

COD. 2014-3x

COD. 9070-7x

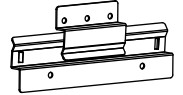
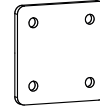
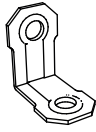
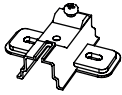
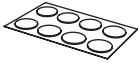

A

B

C

D

E

F

COD. 4157-9x

COD. 2511-4x

COD. 11798-1x

PASSA FIO-2x
 WIRE CHANNEL-2x
 PASAJE DE ALAMBRE-2x
 PASSE-CÂBLES-2x
 RÜCKWANDVERBINDER-2x

SUPORTE TV
 SUPORT TV
 SOPORTE TV
 SUPPORT MURAL POUR TV
 FERNSEHSTÄNDER
 1X

COD. 0348-2x

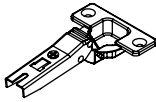
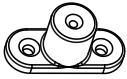

LED

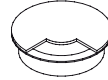

G

H

I

J

K

L

COD. 2088-18x

COD. 10063-20x

COD. 3557-75x

COD. 3706-30x

COD. 3527-24x

COD. 7519-16x

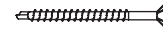
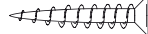
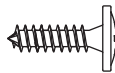

M

N

O

P

Q

R

COD. 4762-6x

COD. 6244-14x

COD. 4505-4x

COD. 9895-20x

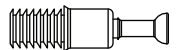
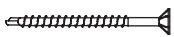

S

T

U

V

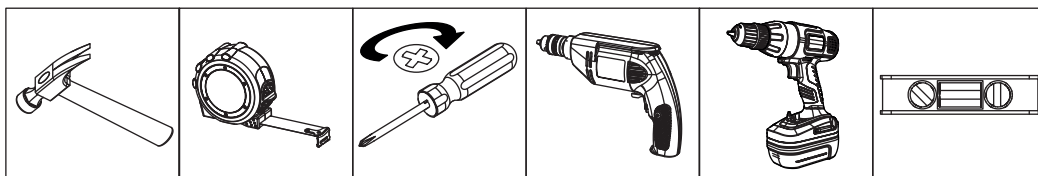

DESCRIÇÃO/DESCRIPTION/DESCRIPCIÓN/DESCRIPTION/BESCHREIBUNG

CÓD:29200

PEÇA PART PIEZA PIECE STÜCK	QUANTIDADE QUANTITY CANTIDAD QUANTITÉ MENGE	DESCRIÇÃO	DESCRIPTION	DESCRIPCIÓN	DESCRIPTION	BESCHREIBUNG	CAIXA BOX CAJA BOITE BOX
01	01	PAINEL INFERIOR	BOTTOM PANEL	PANEL INFERIOR	PANNEAU INFÉRIEUR	UNTERES PANEEL	01
02	01	PAINEL SUPERIOR	UPPER PANEL	PANEL SUPERIOR	PANNEAU SUPÉRIEUR	OBERES PANEEL	01
03	01	LATERAL PAINEL	PANEL SIDE	LATERAL PANEL	CÔTÉ DE PANNEAU	SEITENPANEEL	02
04	02	SARRAFO LAT TRAS.	BACK SIDE SUPPORT	SOPORTE LATERAL TRAS.	LATTE LATÉRALE DERRIÈRE.	HINTERE SEITENHOLZLEISTE	02
05	04	SARRAFO FRONTAL	FRONT SUPPORT	SOPORTE FRONTAL	LATTE ANTÉRIURE	INNERE SEITE	01
06	01	PAINEL TRAS. SUP	UPPER BACK PANEL	PANEL SUPERIOR TRAS	PANNEAU DERRIÈRE SUPÉRIEUR	OBERES HINTERES PANEEL	01
07	01	PAINEL TRAS. INF	BOTTOM PANEL	PANEL INFERIOR	PANNEAU DERRIÈRE INFÉRIEUR	UNTERES HINTERES PANEEL	01
08	01	LATERAL PAINEL	PANEL SIDE	LATERAL PANEL	CÔTÉ DE PANNEAU	SEITENPANEEL	02
21	01	TAMPO SUPERIOR	TOP BOARD	CUBIERTA SUPERIOR	PLATEU SUPÉRIEUR	OBERE PLATTE	02
22	01	TAMPO CENTRAL	CENTER BOARD	CUBIERTA CENTRAL	PLATEAU CENTRALE	OBERER TRENNER	02
23	01	TAMPO INFERIOR	BOTTOM BOARD	CUBIERTA INFERIOR	PLATEAU INFÉRIEUR	UNTERE PLATTE	02
24	02	DIVISORIA SUPERIOR	UPPER DIVIDER	DIVISIÓN SUPERIOR	DIVISEUR SUPÉRIEUR	OBERER TRENNER	01
25	02	DIVISÓRIA INFERIOR	BOTTOM DIVIDER	DIVISIÓN INFERIOR	DIVISEUR INFÉRIEUR	UNTERER TRENNER	01
26	02	LATERAL	LEFT	LATERAL	CÔTÉ	SEITE	01
27	02	PORTA	DOOR	PUERTA	PORTE	TÜR	02
28	01	PAINEL TRASEIRO	BACK PANEL	PANEL TRASERO	PANNEAU DERRIÈRE SUPÉRIEUR	HINTERES PANEEL	01
29	02	SARRAFO	BATTEN	SOPORTE	LATTES	HOLZLEISTE	02

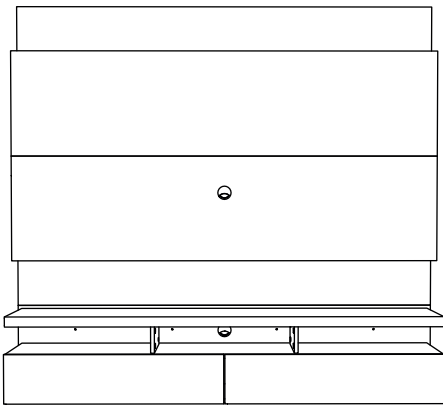

L:1802mm A:1650mm P:388mm
 W:70.94in H:64.96in D:15.28in
 L:1802mm A:1650mm P:388mm
 L:1802mm H:1650mm P:388mm
 B:1802mm H:1650mm T:388mm

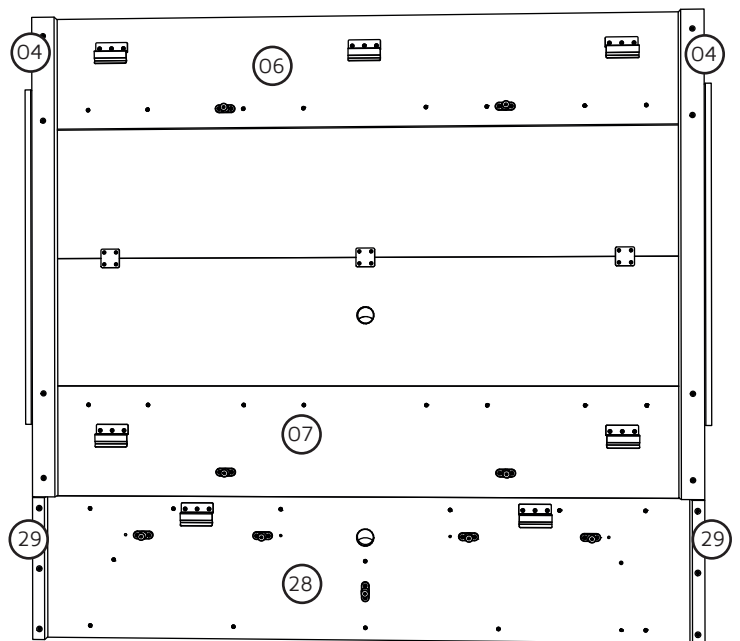
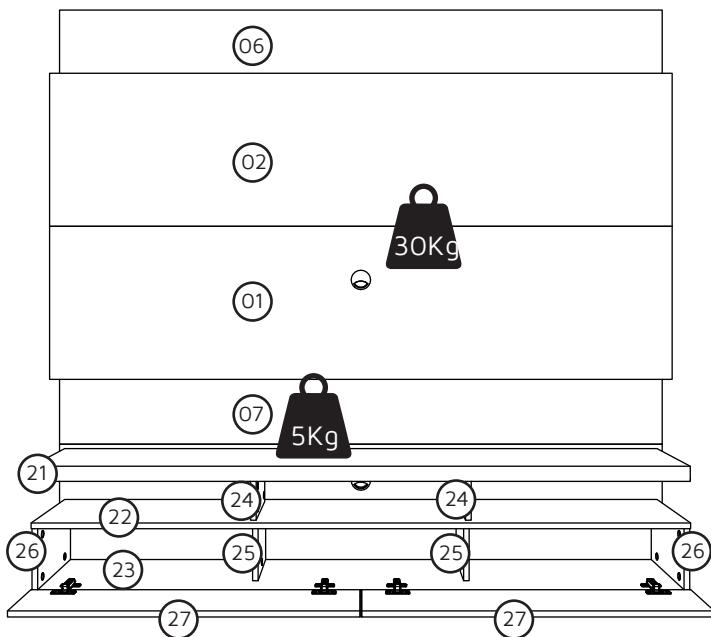
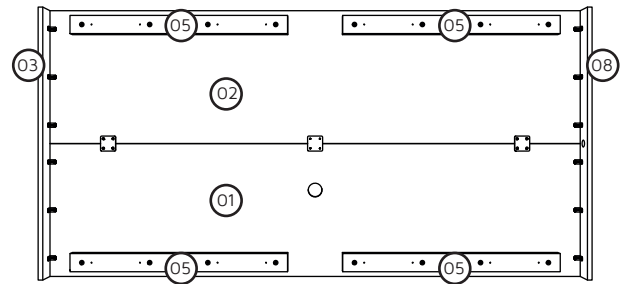

30Kg = 66Lb
 5Kg = 11Lb

01

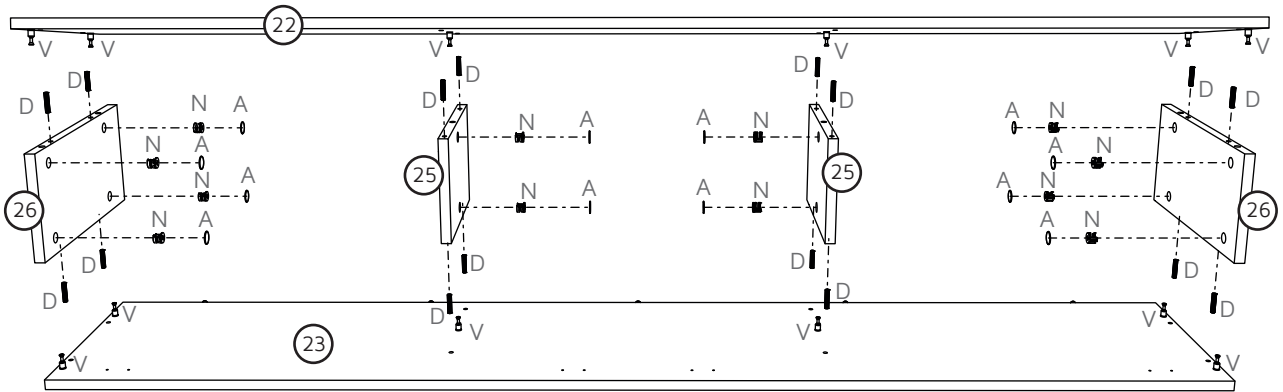

02

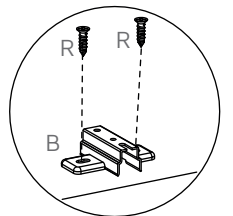
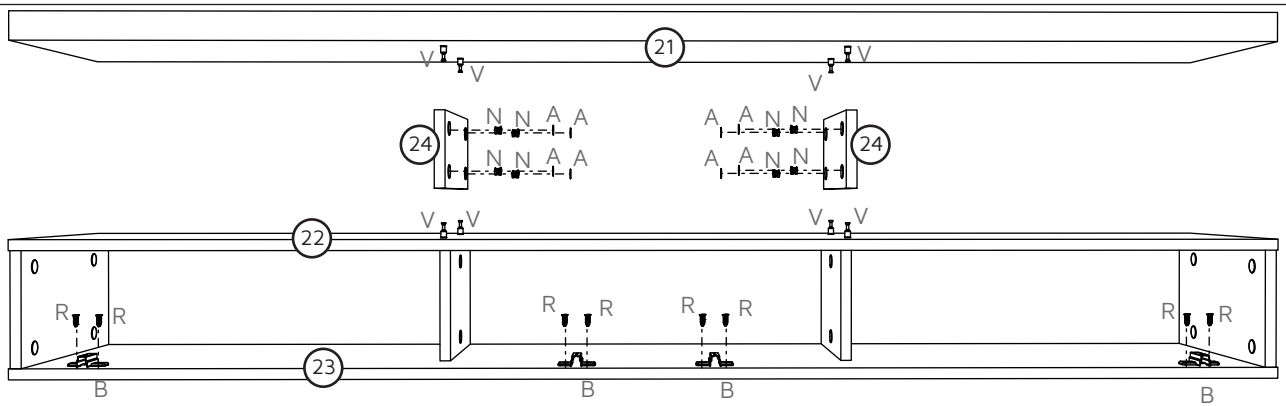

03

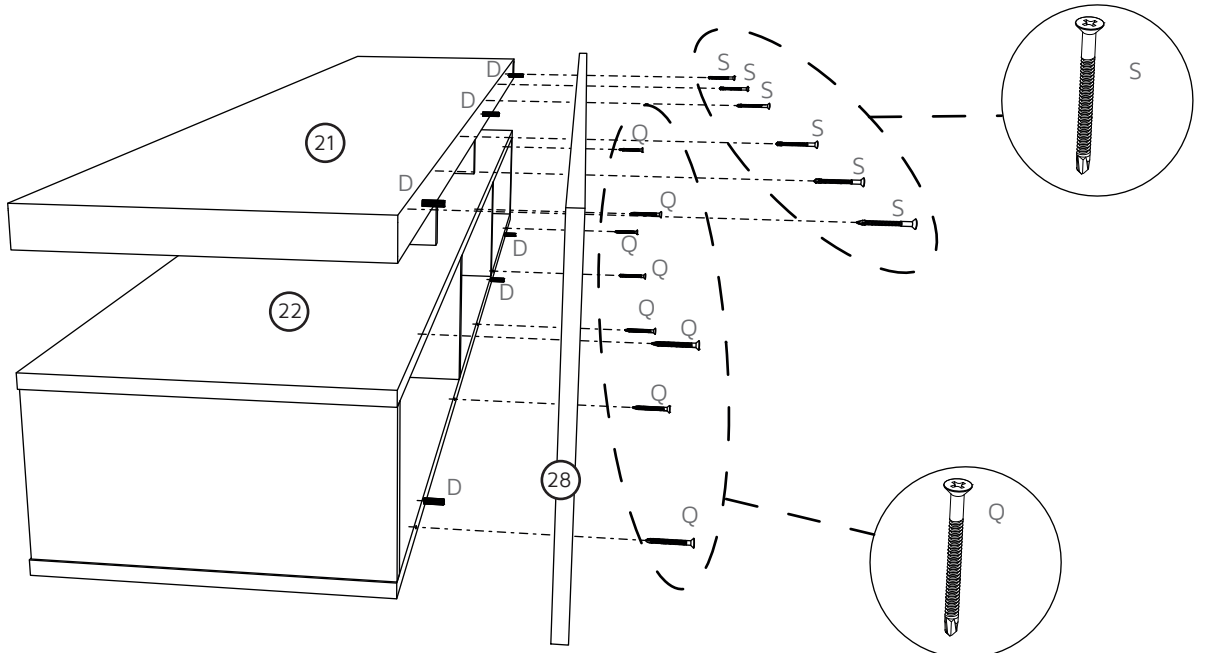

04

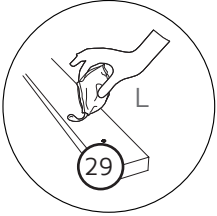
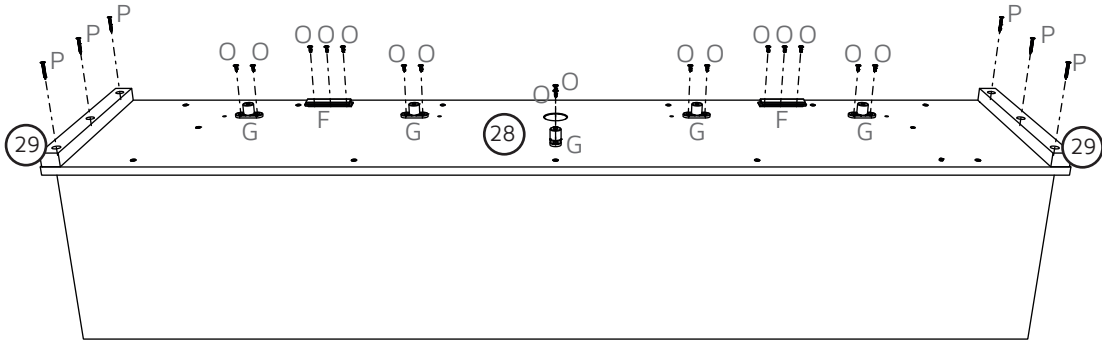

Utilize a cola PVA antes de aparafusar.
 Use the PVA glue before screwing.
 El uso de pegamento PVA antes de atornillar.
 Utilisez la colle PVA avant de visser.
 Vor dem Verschrauben verwenden Sie PVA-Kleber.

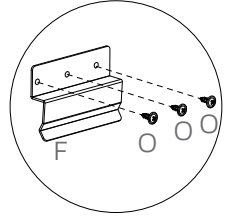

05

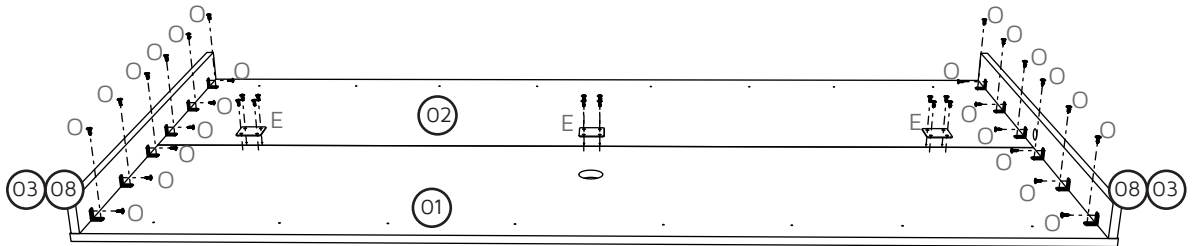
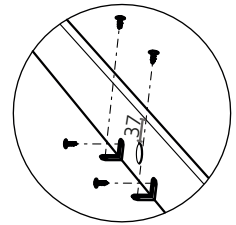
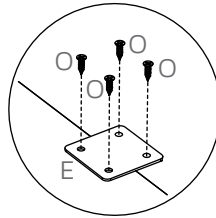
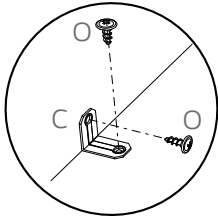

06

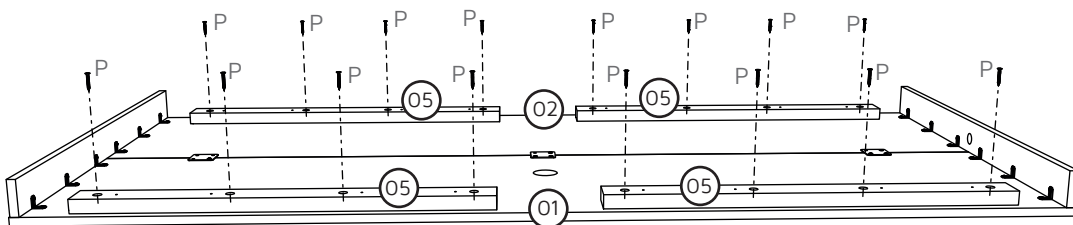

Utilize a cola PVA antes de aparafusar.
 Use the PVA glue before screwing.
 El uso de pegamento PVA antes de atornillar.
 Utilisez la colle PVA avant de visser.
 Vor dem Verschrauben verwenden Sie PVA-Kleber.

07**ATENÇÃO/ATTENTION/ATENCIÓN/ATTENTION/ACHTUNG**

A aplicação do produto LED deve ser feita nesta etapa.

A peça 8 pode ser montada tanto do lado direito quanto do lado esquerdo do móvel, a depender da necessidade de se colocar o interruptor do led.

The LED lights must be assembled in this step.

Part 8 can be mounted on both the right and left sides of the furniture, depending on the need to fit the LED switch.

La instalación del LED debe realizarse en este paso.

La pieza 8 se puede montar tanto en el lado derecho como en el lado izquierdo del mueble, dependiendo de la necesidad de colocar el interruptor del led.

L'application du produit doit se faire à cette étape.

La pièce 8 peut être assemblée sur le côté gauche ou droit du meuble, selon la nécessité d'installer un interrupteur pour le LED.

Die Einstellung des LED-Produkts sollte zu diesem Zeitpunkt erfolgen.

Teil 8 kann entweder an der rechten oder der linken Seite des Möbelstücks montiert werden, je nachdem, ob der LED-Schalter angebracht werden muss.



KIT FITA 2x1,6 M
COM INTERRUPTOR
ENTRADA: 100-240Vac
POTÊNCIA: 3000K

LED LIGHTS SET 2x1,6 m
WITH SWITCH
INPUT: 100-240Vac
POWER: 3000K

KIT FITA 2x1,6 M
COM INTERRUPTOR
ENTRADA: 100-240Vac
POTENCIA: 3000K

KIT RUBAN 2x1,6M
AVEC D'INTERRUPTEUR
TENSION: 100-240Vac
PUISSANCE: 3000K

Kabel 2x 1,6m
Mit Schalter
Eingang: 100-240 V AC
Leistung: 3000K

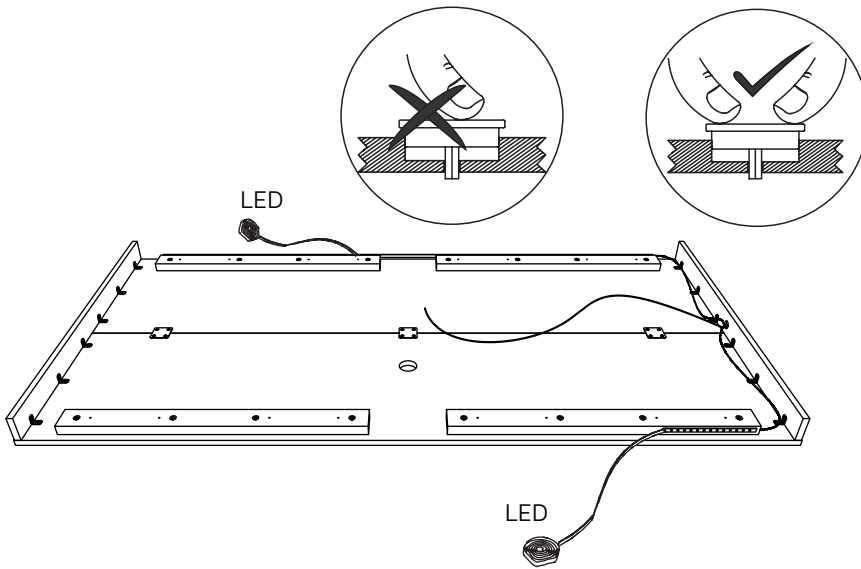
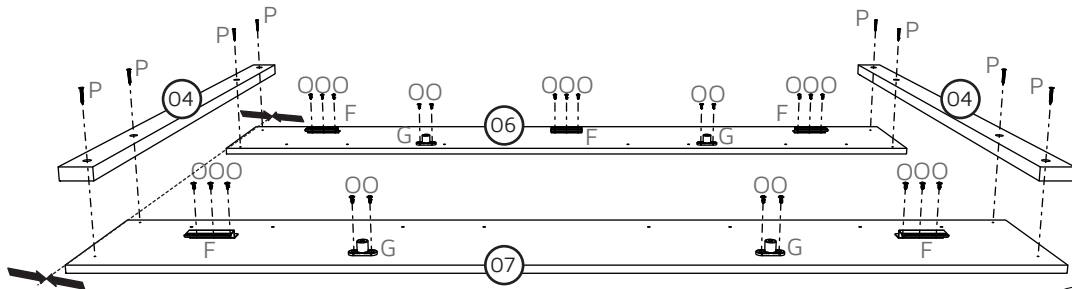
**08**

Utilize a cola PVA antes de aparafusar.
Use the PVA glue before screwing.
El uso de pegamento PVA antes de atornillar.
Utilisez la colle PVA avant de visser.
Vor dem Verschrauben verwenden Sie PVA-Kleber.

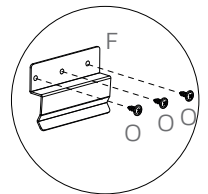
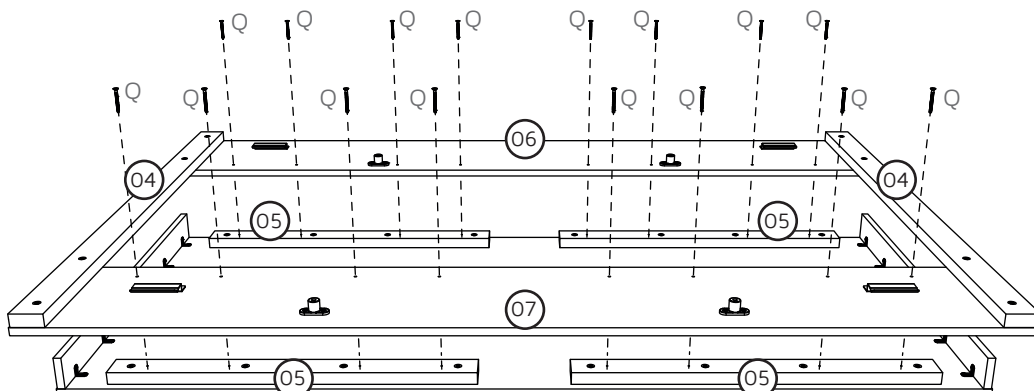
**09**

10

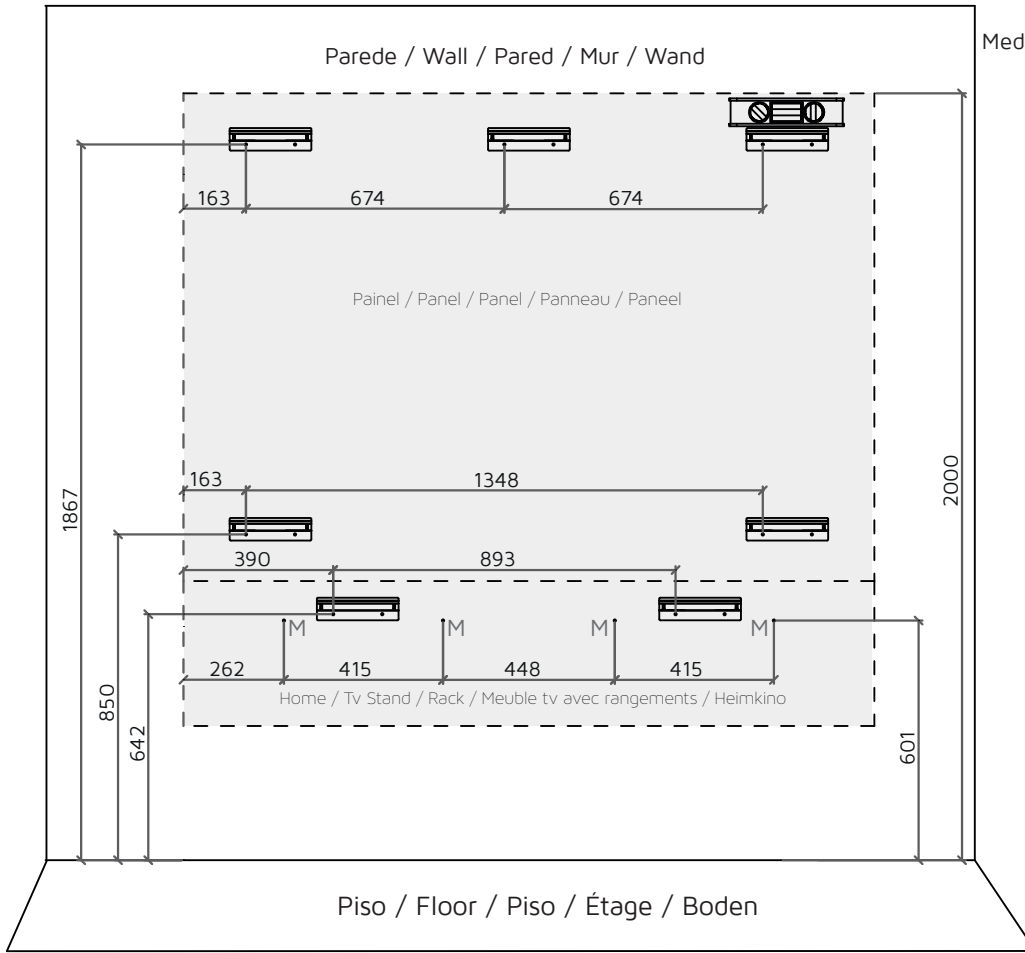

Medidas para realizar a furação da parede (em milímetros).
 Measurement to drill the wall (in millimeters).
 Medidas para realizar la perforación de la pared (en milímetros).
 Mesures pour percer le mur (en millimètres).
 Maße zum Bohren der Wand (in Millimetern).

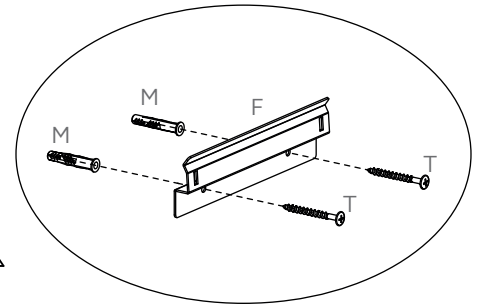
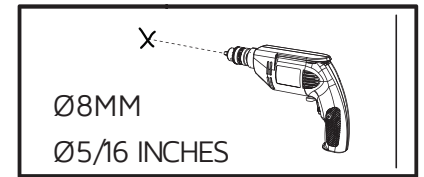
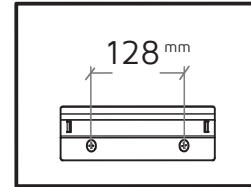

11

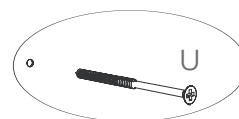
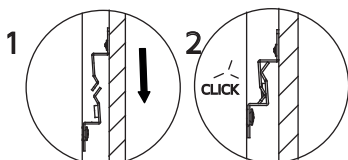
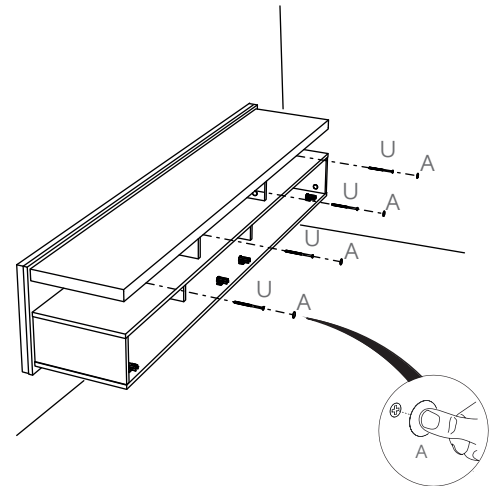
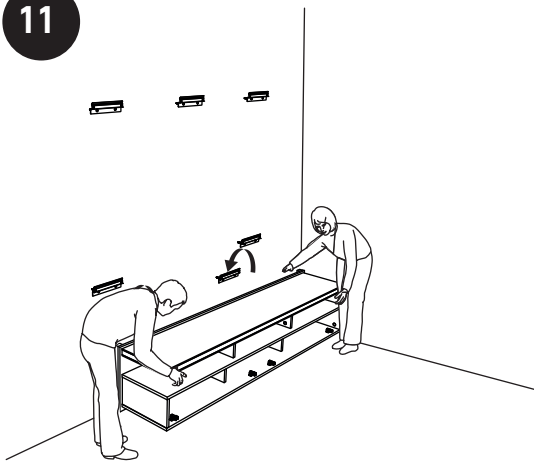

PARAFUSO DE SEGURANÇA
 SAFETY SCREW
 TORNILLO DE SEGURIDAD
 VIS DE SÉCURITÉ
 SICHERHEITSCHRAUBE

Passar cabos antes de aparafusar (U).
 Pass the cables through the wire channel before screwing (U).
 Lleve el cables antes atornillar (U).
 Acheminez les câbles avant de visser (U).
 Führen Sie die Kabel vor dem Festschrauben (U) durch.

12

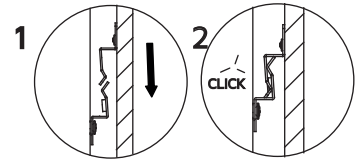
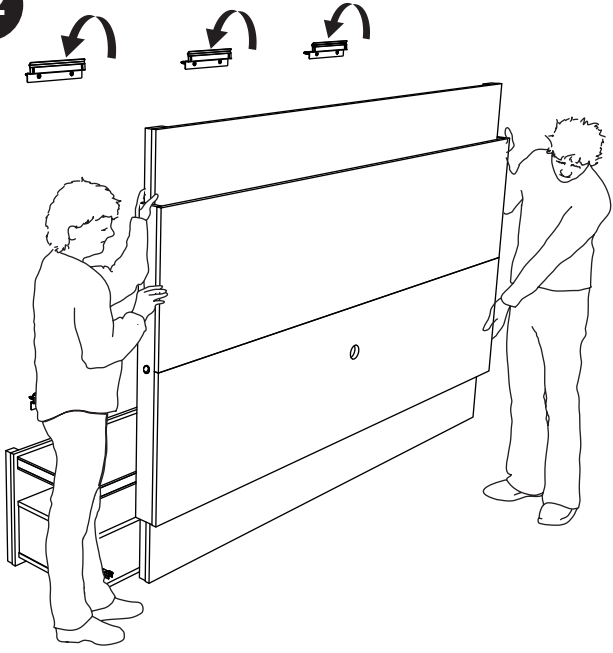

Passar cabos antes de encaixar Painel.
 Pass the cables through the back before Panel.
 Lleve el cables antes de encajar el panel.
 Acheminez les câbles avant de fixer le panneau.
 Führen Sie die Kabel durch, bevor Sie das Wandpaneel einsetzen.

13

