

MANUAL DE MONTAGEM

ASSEMBLY INSTRUCTIONS

INSTRUCCIONES DE MONTAJE

NOTICE DE MONTAGE

MONTAGEANLEITUNG

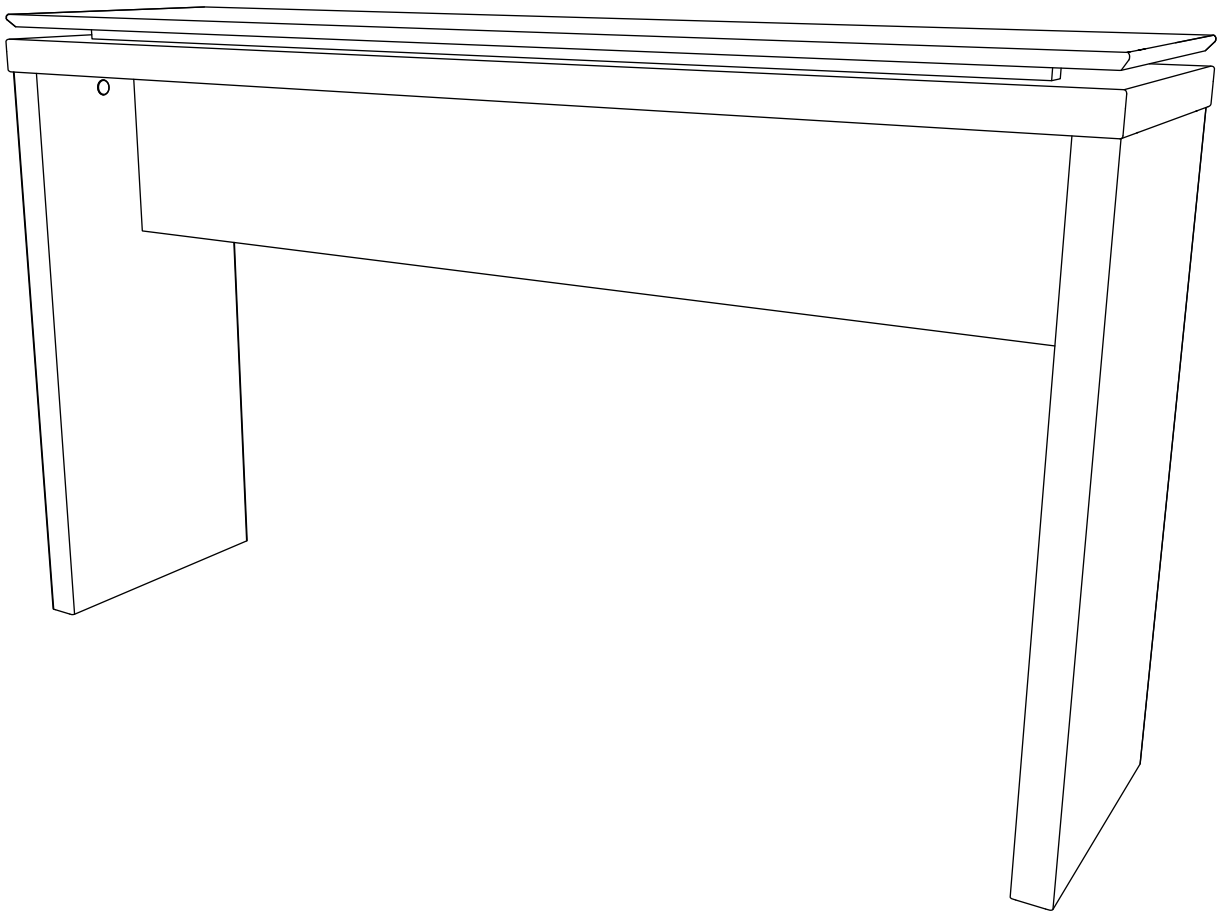

COD BR: 254500

REV. 01 - 14/04/20

COD. 9895



A

COD. 10063



B

COD. 1533



C

COD. 1668



D

COD. 0136



E

COD. 3525

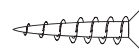

F

ADESIVO
STICKER
ADHESIVO
AUTOCOLLANT
AUFKLEBER

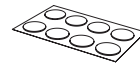

G

DESCRIÇÃO/DESCRIPTION/DESCRIPCIÓN/DESCRIPTION/BESCHREIBUNG

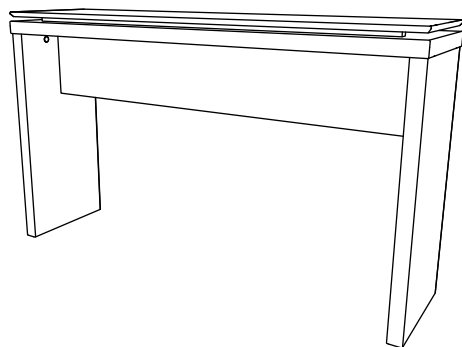

L:1350mm A:788mm P:352mm
W:53.15 inches H:31.03 inches D: 13.86 inches
L:1350mm A:788mm P:352mm
L:1350mm H:788mm P:352mm
B:1350mm H:788mm T:352mm

CÓD:254500							
PEÇA PART PIEZA PIECE STÜCK	QUANTIDADE QUANTITY CANTIDAD QUANTITÉ MENGE	DESCRIÇÃO	DESCRIPTION	DESCRIPCIÓN	DESCRIPTION	BESCHREIBUNG	CAIXA BOX CAJA BOÎTE BOX
10	01	TAMPO	TOP BORD	CUBIERTA	PLATEAU	PLATTE	01
11	02	LATERAL	SIDE	LATERAL	CÔTÉ	SEITE	01
12	01	BANDEIRA	BACK SUPORT	REFUERZO	PLANCHE EN BOIS	BLLENDE	01
13	01	TAMPO SUPERIOR	UPPER BOARD	CUBIERTA SUPERIOR	PLATEU SUPÉRIEUR	OBERE PLATTE	01
14	02	SARRAFO	BATTEN	SOPORTE	LATTES	HOLZLEISTE	01

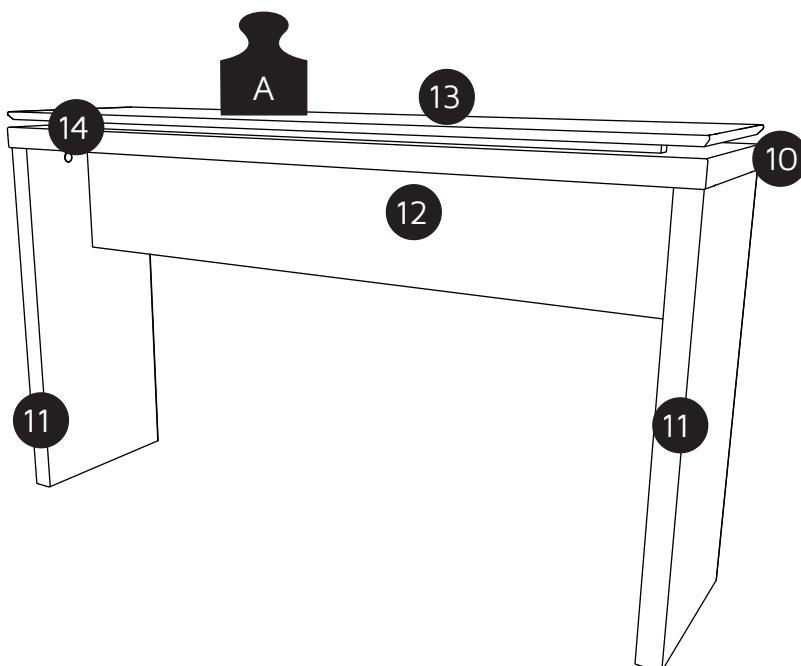

A = 15KG - 33LB

01

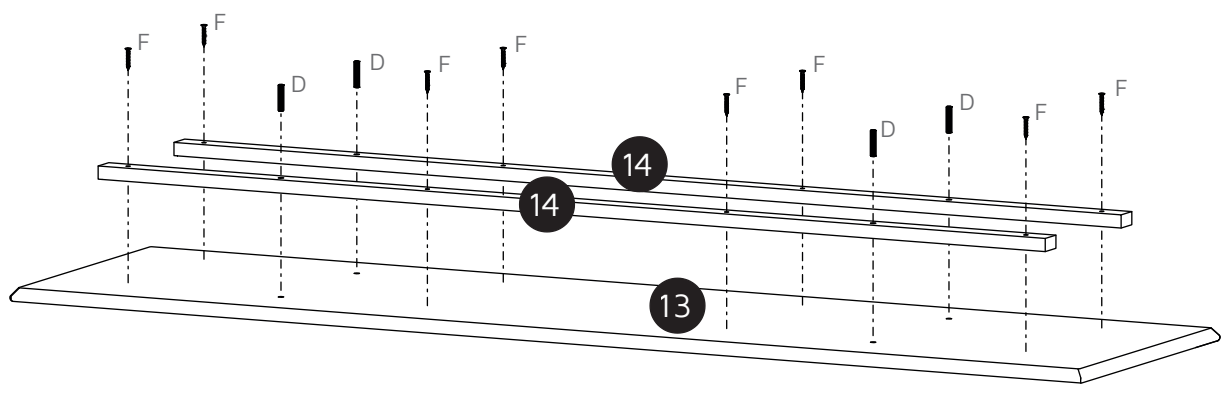
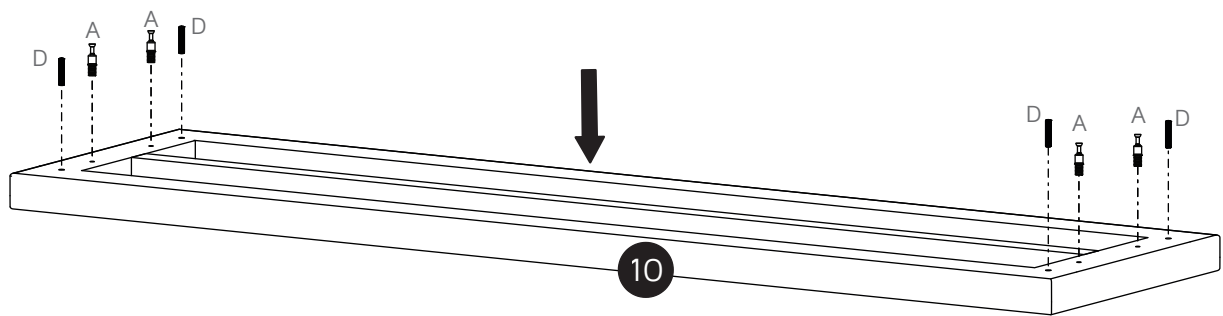

02

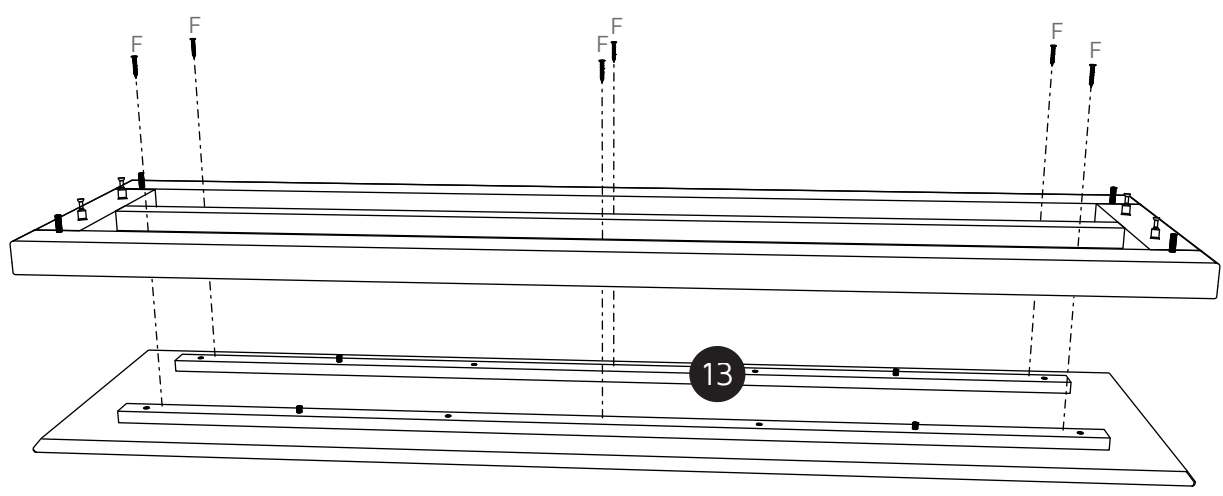

03

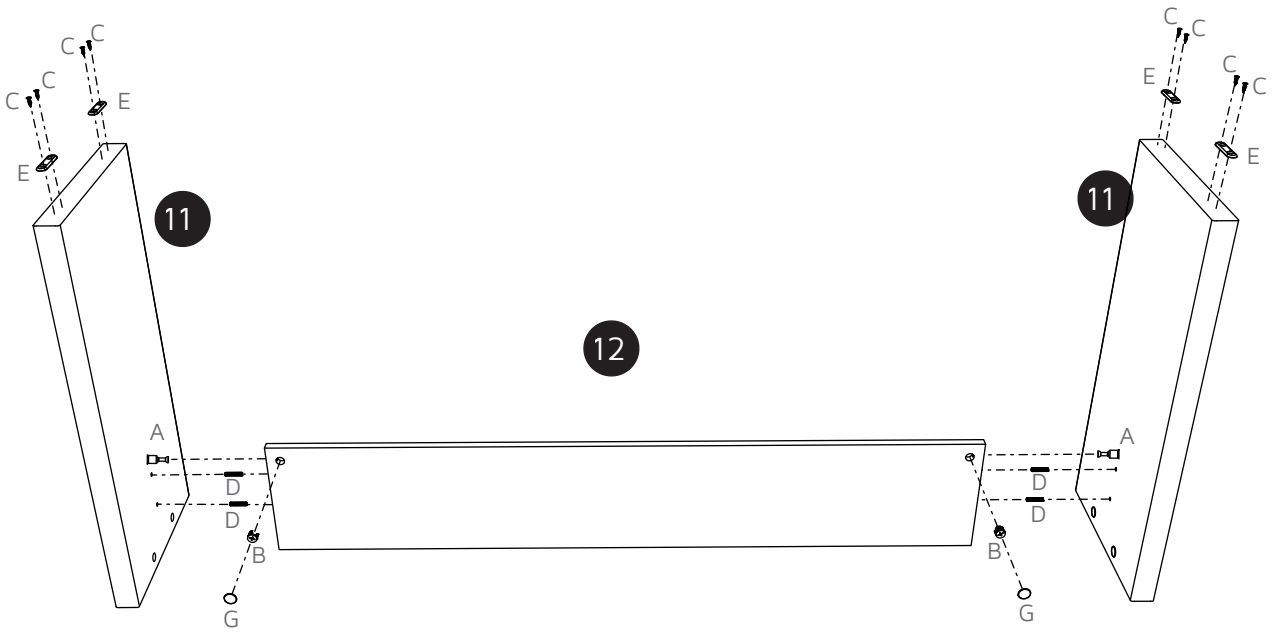

04

