

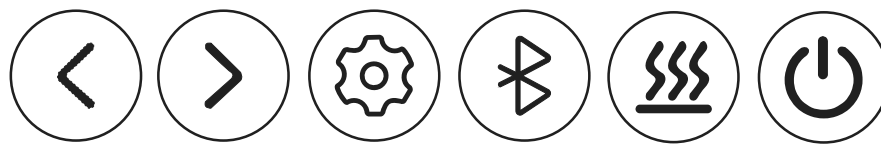

Manual Instruction

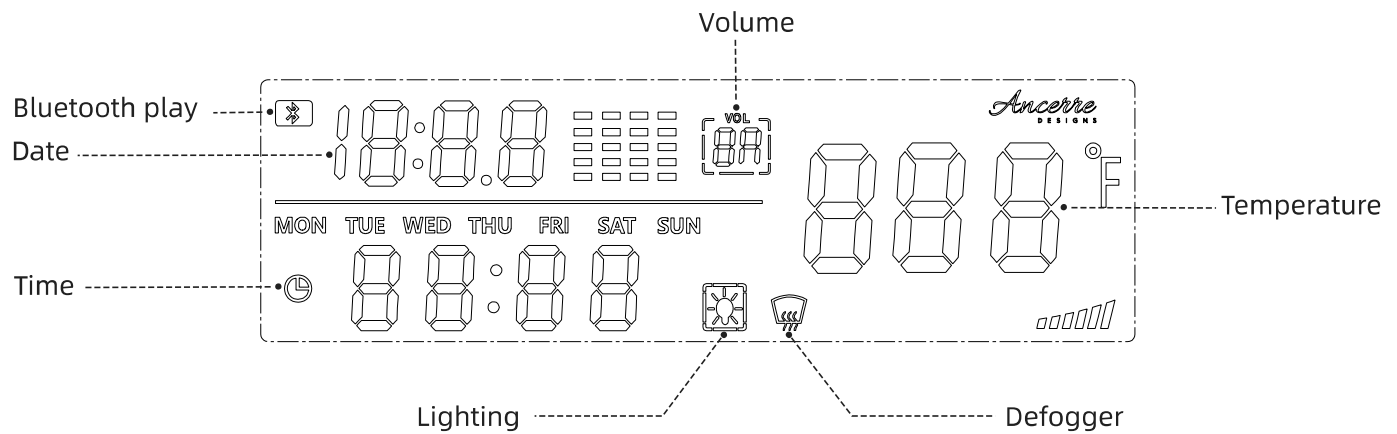
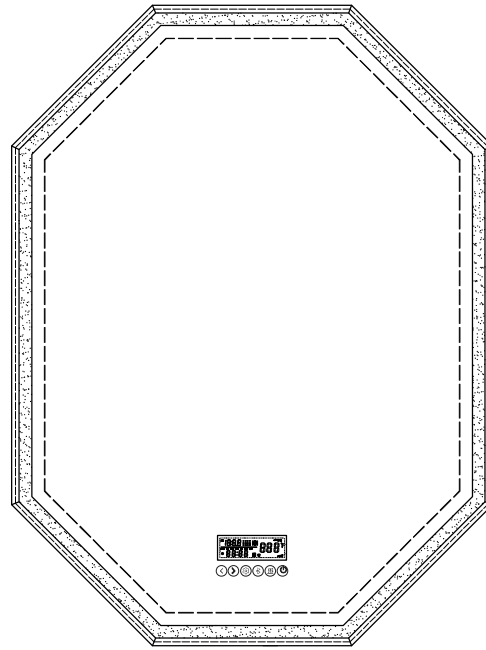

- ① Down
- ② Up
- ③ Setting
- ④ On/off switch / CCT adjusting
- ⑤ Defogger
- ⑥ Bluetooth play

Operating instructions

A. Turn on/off lighting & CCT adjusting





Short press button  to start light working. Then short touch button  (<1s) to switch the color Temperature 2800K or 6000K.

B. Defogger

Press button . the defogger sign will light up on the display and start working .





C. Bluetooth Speaker

1. Press button  will turn on the Bluetooth Speaker function; turn on the Bluetooth function on your device and search for "Ancerre design " to connect. When connected successfully ,the Bluetooth sign will light up on the display screen and the mirror will work as a speaker .

2. Press button  to pause /restart the speaker when you need to; short touch button  for few seconds till the volume number starts flashing ,press  and  to increase or decrease the number.

3. Press  and  to to choose the next/last songs during playing music.

D. Reset the Time Year & Date

1. Hold button  for few seconds to engage the time program mold until the minute number starts flashing . Press  or  button to increase or decrease the number to correct hour; then short press button  to set minutes and once it worked ,touching button  to set correct year as it is .

2. After year settled down ,repeat the step to reset the month and date accordingly.

Care & Maintenance

"NOTE": Use warm soap water and a soft ,damp ,lint-free cloth to clean the mirror. Wipe dry with another clean cloth .Glass cleaner can be used on the mirror surface when required .Avoid scourers ,abrasives and chemical cleaners as they can damage the glass and the frame .

In hard water areas ,limescale may deposit on the glass .Regular cleaning will minimize this problem. If this build-up becomes increasing difficult to remove ,apply a small amount of white vinegar on the area .

 Do not attempt to cut the glass .

 Do not hit the glass with hard or sharp article.

Installation Instructions

Please read follow warm tips before installation !

- ⚠ Power off electrical before installation. Use voltage detector to make sure. Verify the circuit breaker is turned off & lock it in case someone try to turn it on.
- ⚠ If you're NOT experienciend in installing electrical wiring, then hire a professional electrician. Your safety is more important then saving a few dollars.
- ⚠ Avoid water at all times when working with electricity. Never touch or install any electrical equipment or circuits with wet hands.
- ⚠ Tools you will need: voltage tester, wire cutters, wire and cable strippers, needle nose pliers, continuity tester, and wire closure.
- ⚠ Wear Safety Glasses and Protective Clothing to protect you from sparks.

Installation Tools Needed

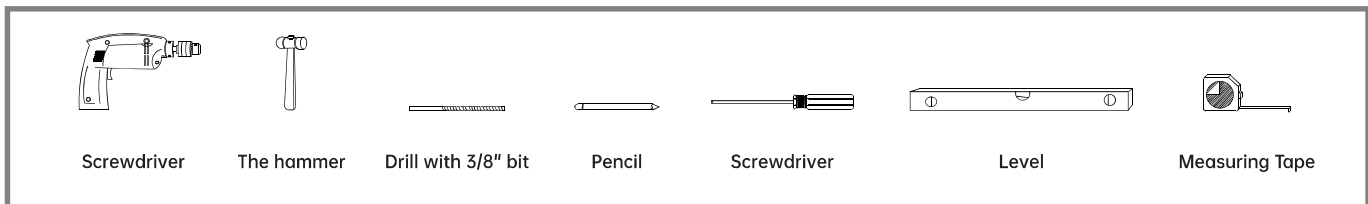

Installation manual

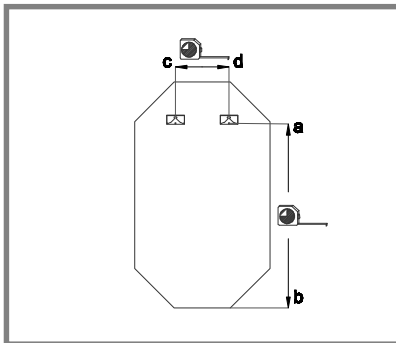

Step 01: Check the wall. Make sure that the wall is bearing walls that can support the Mirror's weight. Measure the width and height of the mirror back holes/hocks distance with a tape measure.

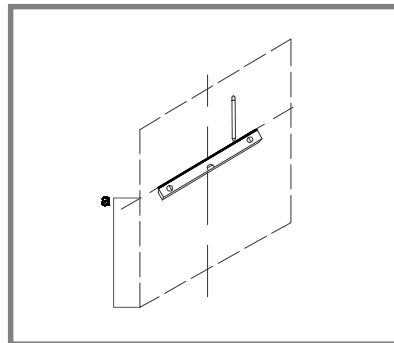

Step 02: Mark the punching position on the wall with a pencil. use level gauge make sure the hole at the same level.

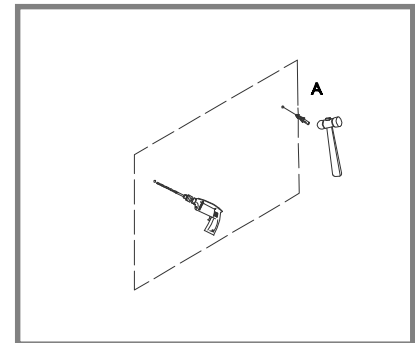

Step 03: Use impact drill punch holes in the marked center (6-8MM drill bit), the drilling depth is about 5CM. Use a hammer to drive the expansion screw into the drilled hole.

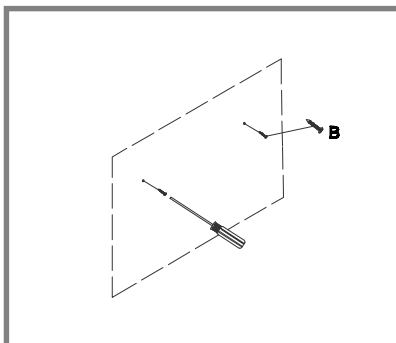

Step 04: Use screwdriver screw the screw into the expansion screw, tighten. And then leave a distance of about 5MM from the wall.

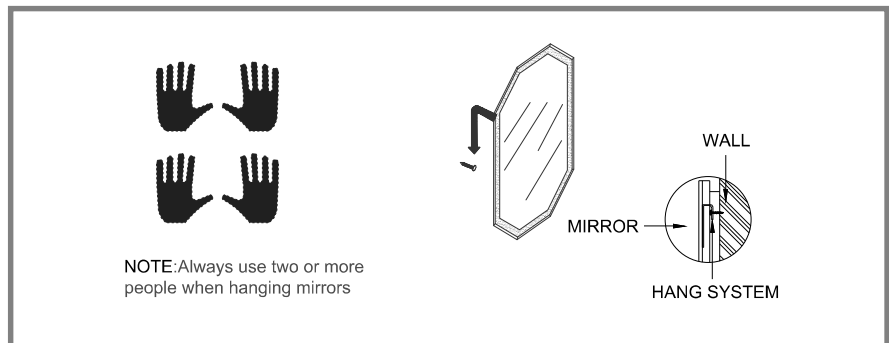

Step 05: Hand the mirror up with screw.