

noodoe EV



Noodoe EV AC7L/AC7LC User Manual



Dust and Water
Protection NEMA 4



Authorization



Management



Easy
Maintenance



Easy Installation

techsupport@noodoe.com

COPYRIGHT © 2022 Noodoe Corporation reserves the right to
make changes to this product without further notice.

Version 1.0A

CONTENTS

Introduction/User Experience /Noodoe EV Operating System (EV OS)/ Autonomous Revenue Generation.....	2
Pricing/User Management/Extensibility	3
1. Important Safety Instructions	4
2. Introduction	7
2.1 Product View.....	7
2.2 Box Opening Process.....	9
3. Specifications	11
4. Installation	13
4.1 Before Installation	13
4.2 Tools & Parts Required for Installation	14
4.3 Install the SIM Card (for AC7LC Only)	15
4.4 Install the Charge Point	18
4.5 Input Cord Connection	22
4.6 Install the Holster	26
4.7 Gateway Installation	29
4.8 Gateway Installation Scenario	30
5. Getting Started	31
5.1 Setting Up the Local Network	31
5.2 Web-page Overview	32
5.3 Configuration	37
5.4 Maintenance	58
5.5 EVSE Status	63
5.6 LLM Status	64
5.7 Security.....	76
6. Activation Instructions	77
6.1 Activation Overview	77
6.2 Prior to Activation.....	78
6.3 Creating a Site.....	79
6.4 Adding Charging Stations.....	80
6.5 Taking Charging Station Photos.....	80
7. Operations	81
7.1 Charging Status Indicators	81
7.2 Authorization (for AC7LC Only)	81
7.3 Charging an Electric Vehicle (EV)	82
7.4 Stop charging.....	84
7.5 General care.....	85
7.6 Customer support	85
8. Federal Communication Commission Interference Statement	86
9. Industry Canada Statement	87
10. Maintenance	89
10.1 Daily Maintenance	89
10.2 Maintenance Supplies	89

Introduction

Noodoe EV AC chargers offer convenience and efficiency to both customers and service providers. These charging stations feature simple installation and management. AC chargers are easy additions to any location and are highly requested by EV-driving customers. They are excellently suited to retail and commercial parking lots, workplaces, restaurants, multi-unit dwellings, and anywhere else looking to provide a smooth, convenient charging experience. Noodoe EV AC chargers are sturdy and can stand up to the elements. They are safety certified, and the design is both waterproof and dustproof. Install them anywhere without environmental concerns.

User Experience

The Noodoe EV charger is easy to engage with and use. It features a simple design to make charging a truly painless experience. Drivers need only scan, plug in, and charge. No annoying memberships or app downloads are necessary. Users can begin charging either through an authorized RFID smart card (perfect for office staff or apartment buildings), the Noodoe mobile app, or our online web portal.

Noodoe EV Operating System (EV OS)

Noodoe EV OS is a cloud-based operating system that unifies the management of all Noodoe EV charging stations. It centralizes charger operation and streamlines the administration of the entire charging network. The EV OS dashboard pulls together information from every connected charger, providing a wealth of information right at your fingertips. Revenue generation becomes practically hands-free as EV OS implements your chosen settings. It even runs charging station diagnostics and self-repair protocols, dramatically reducing the need for expensive maintenance and repairs.

Autonomous Revenue Generation

- Noodoe EV OS supports autonomous revenue generation by streamlining all aspects of EV charger management.
- Service providers have access to up-to-the-minute data on usage, monetization, power status, and more.

- Noodoe EV AC chargers support universal, automatic pay-at-the-pump transactions through Apple Pay, Google Pay, credit cards, or the membership management program in Noodoe EV OS.
- Funds automatically transfer to the management-designated account.

Pricing

- Connect chargers from multiple sites to a shared network in Noodoe EV OS, enabling pricing changes right from the EV OS dashboard.
- Change pricing and availability on the fly or via pre-set, automated schedules with the click of a button.
- Set pricing based on either time taken (price per minute) or energy usage (price per kW).
- Enjoy set-it-and-forget-it automatic peak hour price changes.

User Management

- Chargers can offer multiple pricing tiers through EV OS's integrated user management system.
- Users can make payments through at-the-pump mobile transactions or targeted membership plans for VIPs, special guests, residents, or staff.
- Membership management allows for charging to be available to a select few as a free amenity while still requiring payment by the wider public.
- Integrated user management is ideal for staff and fleet charging, leaving unused chargers available for public use.

Extensibility

- Noodoe EV offers additional software services specially developed for a wide range of charging environments, including those for fleets, workplaces, residences, shopping centers, dealerships, gas stations, smart cities, and more.
- To support the different needs of our customers, Noodoe EV AC chargers support intelligent load balancing, distributing power across multiple chargers on the same network.
- Noodoe EV load balancing means more chargers can be installed on the same site without costly site upgrades.

1. IMPORTANT SAFETY INSTRUCTIONS

This document contains instructions and warnings that must be followed when installing and using the Electric Vehicle Supply Equipment (EVSE). Before installing or using the EVSE, read this entire document as well as WARNING and CAUTION markings in this document.

Safety Instructions

The symbols used have the following meaning:



WARNING: RISK OF PERSONAL INJURY



WARNING: RISK OF ELECTRIC SHOCK



WARNING: RISK OF FIRE



CAUTION: RISK OF DAMAGE TO THE EQUIPMENT

- The charge point must only be installed by licensed electricians.
- Make sure that the materials used and the installation procedures adhere to local building codes and safety standards.
- The information provided in this manual in no way exempts the user of responsibility to follow all applicable codes or safety standards.
- This document provides instructions for the charge point and should not be used for any other product. Before installation or use of this product, review this manual carefully and consult with a licensed contractor, licensed electrician, or trained installation expert to make sure of compliance with local building codes and safety standards.

Repair and Maintenance Clause

- Only licensed electricians can repair or maintain the charge point. It is forbidden for general users to repair or maintain it.
- Turn off input power before repair or maintenance of the charge point.



WARNING: RISK OF ELECTRIC SHOCK

When using electric products, basic precautions should always be taken, This manual contains important instructions that shall be followed during installation, operation and maintenance of the unit.

- Read all instructions before using this product.
- Children should not use the device without adult supervision.
- Do not insert fingers into the EV connector.
- Do not use this product if the flexible power cord or EV cable is frayed, has broken insulation, or displays any other signs of damage.
- Do not use this product if the enclosure or the EV connector is broken, cracked, open, or shows any other indication of damage.
- To avoid the risk of fire or electric shock, do not use this unit with an extension cord.



WARNING: RISK OF ELECTRIC SHOCK

Improper connection of the equipment grounding conductor can result in a risk of electric shock. Check with a qualified electrician or serviceman if you are in doubt as to whether the product is properly grounded.

Do not modify the plug provided with the product. If it will not fit the outlet, have a proper outlet installed by a qualified electrician.



WARNING: RISK OF ELECTRIC SHOCK

Do not remove the cover or attempt to open the enclosure. There are no user serviceable parts inside. Refer servicing to qualified service personnel.



WARNING: RISK OF ELECTRIC SHOCK

- Do not touch live electrical parts.
- Incorrect connections may cause electric shock.
- Do not disconnect under load.



WARNING: This equipment is intended only for charging vehicles that do not require ventilation during charging. Please refer to your vehicle's owner's manual to determine ventilation requirements.



WARNING: Do not use extender cables to increase the length of the charging cable. Maximum length is limited to 25 feet by the National Fire Protection Agency.



WARNING: Do not drag the charge point by its input power cord.



CAUTION: Do not expose to liquid, vapor, or rain.



CAUTION: If this unit is installed outdoors, the outlet must be rated for outdoor installation. The outlet must be installed properly to maintain the proper NEMA rating of the enclosure.

- Installation work and electrical wiring must be done by qualified person(s) in accordance with all applicable codes and standards, including fire-rated construction.
- Do not touch the terminals or other current-carrying parts.
- Take care not to drill into any pipes or power lines beneath the surface when preparing the mounting holes. Use a power line / metal detector.
- Do not trample or drive over the product's cables.
- Do not put any foreign objects into the enclosure.
- Do not start the vehicle's engine when the charging connector is still connected.



CAUTION: Do not use this product if there is any damage to the unit. In the event that the unit is not operational, send it back to the manufacturer.

SAVE THESE INSTRUCTIONS

2. Introduction

This user manual applies to “32 A Level 2 AC Charger for Plug-in Electric Vehicles (PEVs) and Battery Electric Vehicles (BEVs)”.

This Level 2 Electric Vehicle Supply Equipment (EVSE) with 32 A capabilities is for use in North America. It can provide a shorter charging time than the traditional 16 A EVSE.

Any unauthorized modifications will void the manufacturer’s warranty.

2.1 Product View

Different models of AC7L/AC7LC Charger:

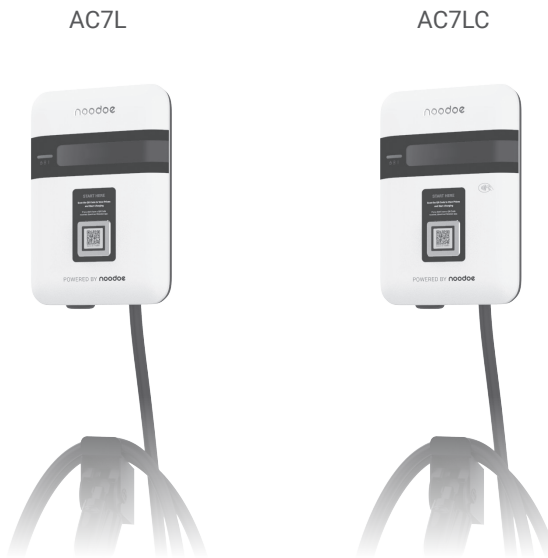

2.1.1 Box Contents

See the table for content differences across the two models.

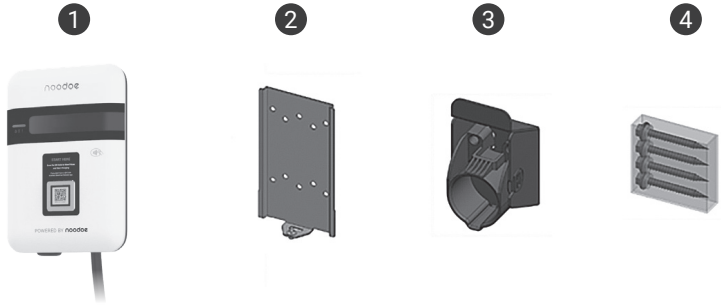

2.1.2 Accessories in the Box

	Description	QTY	Remark
1	AC7L	1	<ul style="list-style-type: none"> ■ Charging Plug ■ OLED Display
	AC7LC		<ul style="list-style-type: none"> ■ Charging Plug ■ RFID Icon ■ OLED Display
2	Mounting Bracket	1	Attached to the back of the charge point
3	Holster ASSY	1	Hook x1, Holster x1 & M4xL15 tapping screw x2
4	Screw Bag	1	#12xL50 tapping screw x4

2.2 Box Opening Process

(Shown with model AC7LC)

Step 1.

Open the carton and remove the upper partition.

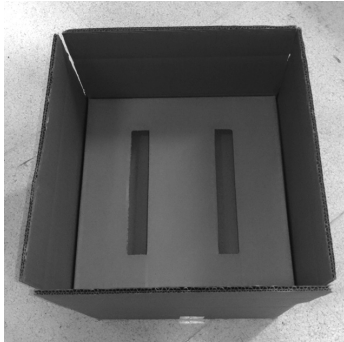

Opening the carton



Charge point device

Step 2.

Take out the charge point and middle partition. The charging plug is in the bottom of the carton.



Take out the charge point



Charging plug

Step 3.

The hook and holster are inside the right section of the middle partition.

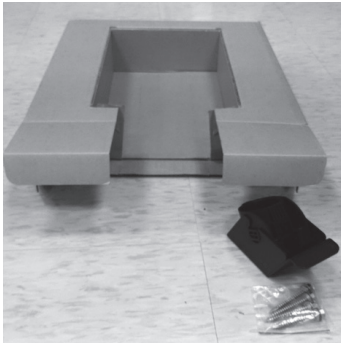

Accessories inside the middle partition



Hook and holster

Step 4.

Release the bottom screw to remove the wall mounting bracket.

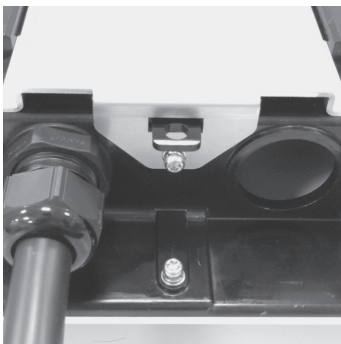

Release the screw

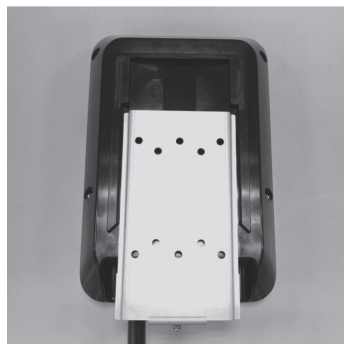

Remove the mounting bracket

3. Specifications

(Note: Certification in process)

Model Name	AC7L	AC7LC
Application	Residential	Commercial
Voltage (Vac)	208/240 Vac, 1-phase	
Frequency (Hz)	60 Hz	
Current (Rms)	32 A	
Charging Connector	SAE J1772 Type 1	
Charging Cable Length	25 feet (18 feet optional)	
Metering Accuracy	Embedded \pm 3%	
Real Time Clock	Yes (7 days)	
Protection	Over voltage protection, under voltage protection, surge protection, GM/I, CCID20, over current protection, over temperature protection, under temperature protection, short circuit protection, relay malfunction/welding protection	
Indication	<ul style="list-style-type: none"> • Green Steady: Ready • Green Flashing (Fast): Authorized, waiting for EV to connect • Green Flashing (Slow): Suspended (Occupying) • Blue Flashing (Slow): Charging • Red Steady: Unrecoverable Fault • Red Flashing (Slow): Recoverable Fault • Yellow Steady: Out of Service • Yellow Flashing (Slow): Booting / Firmware Upgrading • Fast Flash: On Time 300ms, Off Time 200ms, 2Hz • Slow Flash: On Time 1200ms, Off Time 800ms, 0.5Hz 	
Wi-Fi	802.11 b/g/n	
Cellular	N/A	LTE Cat. 1 (AT&T or T-mobile)
RFID	N/A	ISO 14443 A/B, ISO 15693, NFC, NEMA interoperability protocol

Model Name	AC7L	AC7LC
Display	116(L) x 8.5(W) x 37(H) mm, 5.57 mm CHARACTER HEIGHT, 5x8 DOT MATRIX, OLED 20x2	
Data Protocol	OCPP 1.6	
Operation Temp.	-30~50 °C / -22~122 °F	
Storage Temp.	-40~70 °C / -40~158 °F	
Mounting Type	Wall mount / Pole mount (optional)	
Wiring Type	Hard-wired	
IP Performance	NEMA 4	
Impact Resistance	IK10	
Dimensions	7.6 (W) x 11.1 (H) x 3.1(D) in 192 (W) x 283 (H) x 79 (D) mm	
Web Portal Management	Yes	
Console Management	Yes	
Certification	UL 1998/2231/2594 FCC Part 15B	
	FCC Part 15.225 (RFID 13.56 MHz) FCC Part 15.247 (WLAN 2.4 GHz)	
	N/A	FCC Part 27 (AT&T) or Energy Star

4. Installation

4.1 Before Installation

4.1.1 Safety Check

- Check for damages incurred during transportation.
- Before connecting the product to the power supply, check that the power supply voltage and current ratings correspond with the power supply details shown on the product rating label.



CAUTION: Disconnect the power supply before installing or repairing the charge point. Failure to do so may result in physical injury or damage to the power supply system and the charge point.



CAUTION: Avoid touching or pressing the OLED screen at all times, as this may result in damage to the OLED screen.



DANGER: RISK OF SUFFOCATION

Keep any packing materials away from children. These materials are a potential source of danger, e.g. suffocation.

The charge point must be installed only by a licensed electrician in accordance with the provisions of the local electrical industry construction and should comply with national electrical codes and standards.

Before installing the charge point, make sure you have read all instructions in this manual and fully understand its contents.

Appropriate protection is required when connecting to a main switchboard. The tools and parts to be used are outlined in the section "Tools & parts required for installation".

4.1.2 Grounding instructions

The charge point must be grounded through a permanent wiring system or an equipment grounding conductor. Use a wire that has a dedicated grounding wire and a ring terminal and that connects to the equipment ground terminal block for grounding.

4.2 Tools & Parts Required for Installation

Tool	QTY	Model	Size	Supplier	Remark
Mounting Bracket	1	All	194x109x9 mm	Model Accessories	Fasten charge point to the wall
Holster ASSY	1	All	58x58x70 mm	Model Accessories	Hold EV charging plug
Screw	4	All	Tapping: #12	Model Accessories	Fasten Mounting Bracket & Hook
			Mechanical: M6	Commercially Available	
Wire, Copper	3	AC7LC	8 AWG	Commercially Available	UL1015 (recommended)
Heat Shrink Tube	3	AC7LC	For 8 AWG wire	Commercially Available	Protect wires & terminals
Terminal	3	AC7LC	For 8 AWG wire	Commercially Available	Connect input wires to the terminal block
Conduit	1	AC7LC	1 inch	Commercially Available	Protect power cable
Torx Screwdriver	1	All	T20	Commercially Available	
Philips Screwdriver	1	All	PH3	Commercially Available	
Hexagon Socket	1	All	5/16	Commercially Available	Tighten #12 Tapping screws
Torque Wrench	1	All	35 kgf-cm min	Commercially Available	

4.3 Install the SIM Card (for AC7LC Only)

Step 1. Disassemble the Top Cover

Loosen the star screws (x5).

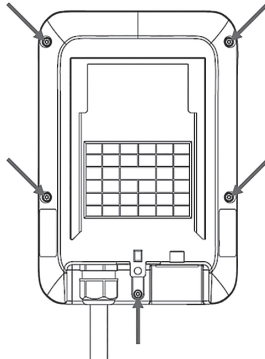

Five screws in the Base Cover position

Step 2. Locate the SIM card socket

SIM Card Socket

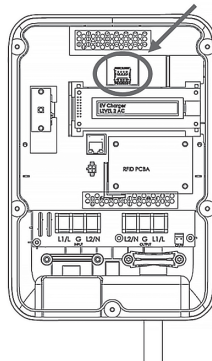

Position of SIM card socket

Step 3. Insert the SIM card

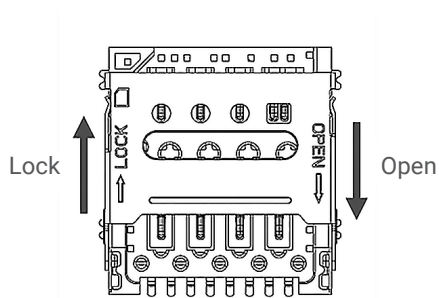

SIM card socket and cover Open/Close direction

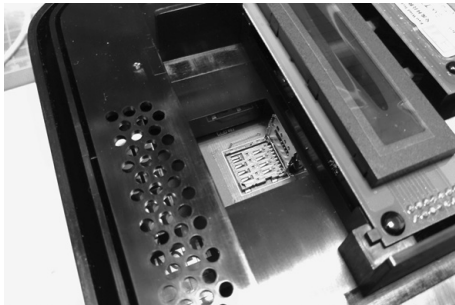

Open the SIM card socket

1. Push down the cover to open the SIM card socket.



Prepare the SIM card

2. Prepare the SIM card. ((Use a Micro SIM card, 15 mm x 12 mm)

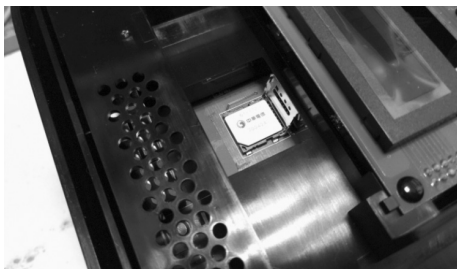

Insert the SIM card

3. Insert the SIM card.

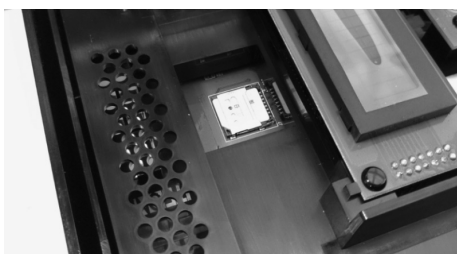

Lock the SIM card socket cover

4. Close the SIM card socket and push the cover in the locking direction to lock the cover.

Screw	Torque	
M4	16 kgf.cm	13.88 lb-in

5. Reassemble the top cover. Please refer to the following torque guidelines. SIM card installation is complete.

4.4 Install the Charge Point

4.4.1 Secure the main body mounting bracket to the wall with the appropriate screw.



DANGER: Disconnect the power at the circuit breaker before installation.



CAUTION: Before mounting the charger, determine a suitable mounting location. The unit must be fixed to a wooden or masonry/concrete wall using hardware that is appropriate for the surface. Do not install on drywalls, wall boards, or thin plywood. The fixing point must be capable of supporting the weight of the unit.

Follow applicable accessibility requirements for the mounting position. The unit shall be stored or located at an appropriate height.

For indoor use: The unit shall be mounted between 18 inches (450 mm) and 4 feet (1.2 m) from the floor.

For outdoor use: The unit shall be mounted between 24 inches (600 mm) and 4 feet (1.2 m) from the floor.

The mounting bracket has ten screw holes. If only two screws are used to fasten the mounting bracket, those screws should pass through the middle two screw holes of the mounting bracket. The other screw holes are reserved for the user.

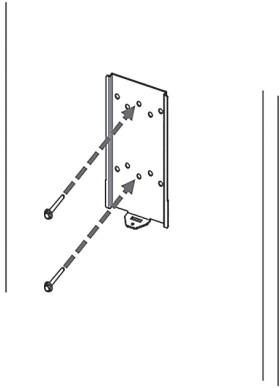

Fixing mounting bracket

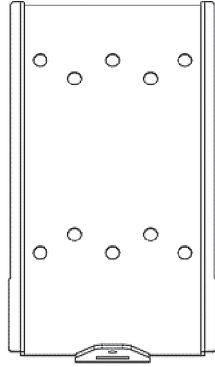

Mounting bracket screw holes

Screw suggestion:

1. For masonry walls, use M6 mechanical screws. (Commercially available)
2. For finished walls supported by wood studs, use 1/4" or M6 tapping screws. (Commercially available)
3. Please use following torque force.

Screw	Torque	
M6	16 kgf.cm	13.88 lb-in
#12	25 kgf.cm min	21.7 lb-in min

4.4.2 Affix the charge point to the mounting bracket and lock the screw.

1. Put the charge point on the mounting bracket.
2. Fix charge point on the mounting bracket with the M4 screw and screw washer.
3. Please refer to the following torque.

Screw	Torque	
M4	16 kgf.cm	13.88 lb-in

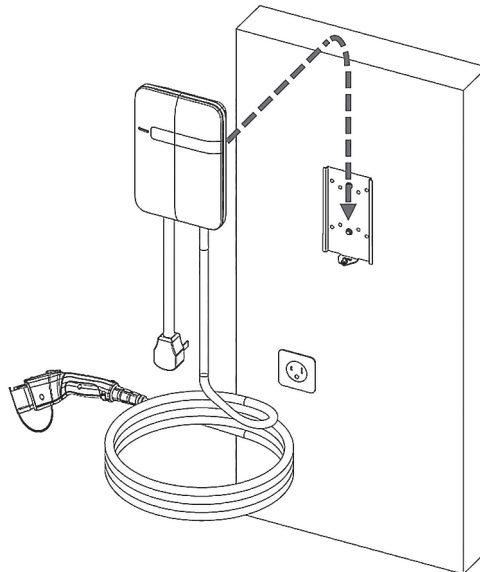

Charge point and mounting bracket

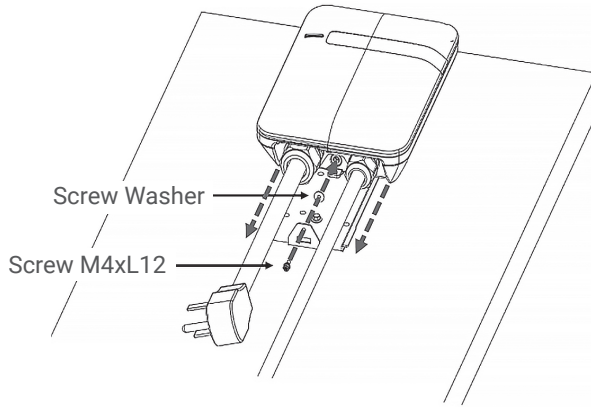

Screw locking position

4.4.3 Plug in the power cord. (AC7L Only)

The outlet should be located 20-26 inches from the ground. Refer to the installation template to decide where to install the charge point.

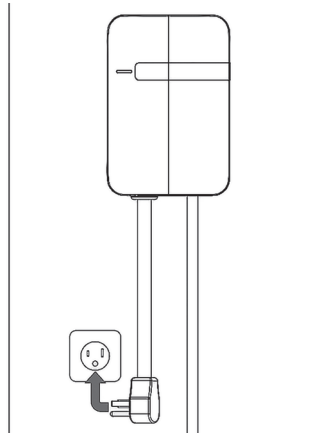

Plug in the power cord

4.5 Input Cord Connection

4.5.1 Choose the appropriate conduit in accordance with all applicable state, local, and national electrical codes and standards.

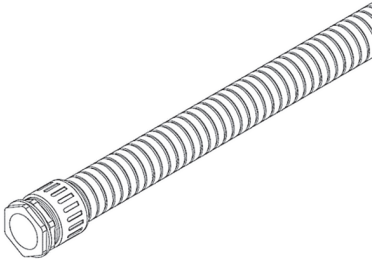

Conduit

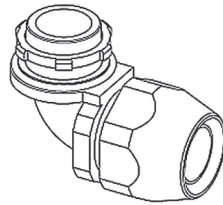

Right angle conduit

4.5.2 Clamp copper terminal to connect copper wire. The clamp point is covered by heat shrink tubing for protecting.

Refer to the following wire specification. Use a conductor type other than RHH, and RHW-2 with outer covering.

Model	Terminal	Conductor	Rating
AC7LC	L1, L2, G	8 AWG	90C copper wire

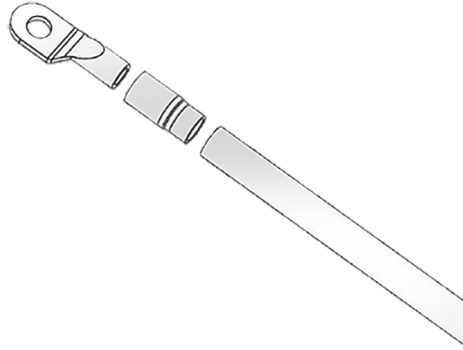

Copper terminal, heat shrink tube and copper wire

4.5.3 Electrical wiring to the charge point.

1. Disassemble the top cover.
2. Use a Philips screwdriver to release the terminal screws.
3. Fold the wire end to pass it through the conduit and insert them into the input hole.
4. Fix the copper wire on the corresponding terminal block. The wiring instruction are printed in front of the terminal block (L1/L2/G).
5. Use the following torque to connect the wire terminal to the terminal block.

Screw	Torque	
M4	16 kgf.cm	13.88 lb-in

6. The recommended terminal specifications are as follows.

Terminal	Dimension(mm)
W	≤ 9.5
d2	4-6.4

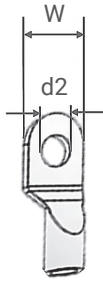

Terminal dimensions

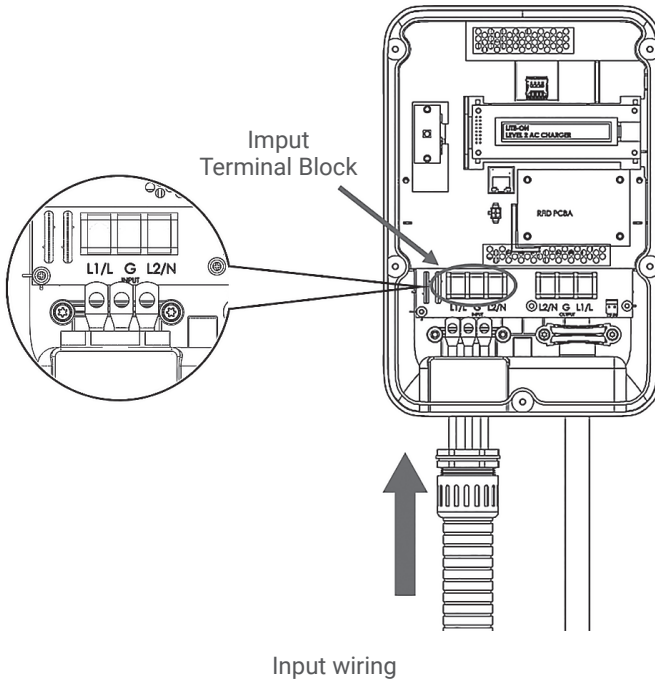



CAUTION: To reduce the risk of fire, connect only to a circuit provided with 40 amperes maximum branch circuit overcurrent protection in accordance with the National Electrical Code, ANSI/NFPA 70, and the Canadian Electrical Code, Part I, C22.1.



CAUTION: If this unit is installed outdoors, the outlet must be rated for outdoor installation. The outlet must be installed properly to maintain the proper NEMA rating of the enclosure.

Model	Current Rating
AC7LC	32 A

7. Lock the conduit on the enclosure. Please refer to the following torque.

Conduit	Torque	
1 "	35 kgf.cm	30.36 lb-in

Screw	Torque	
M4	16 kgf.cm	13.88 lb-in

4.6 Install the Holster

4.6.1 Separate the holster from the hook.

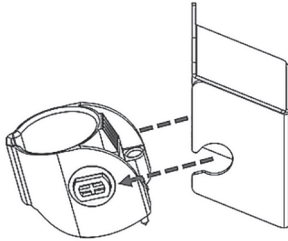

Separate the holster

4.6.2 Fasten the hook to the wall with appropriate screws.

1. For finished walls supported by wood studs, use #12 tapping screws (x2).
2. The recommend torque is 25 kgf.cm (21.7 lb-in).

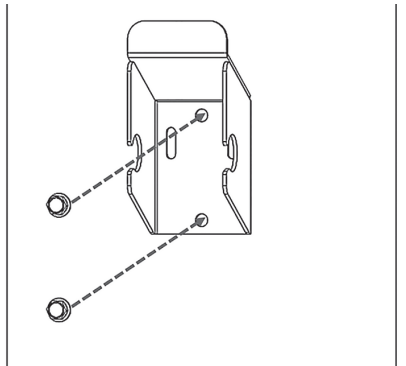

Secure the hook

4.6.3 Make the holster face up and secure it to the hook.

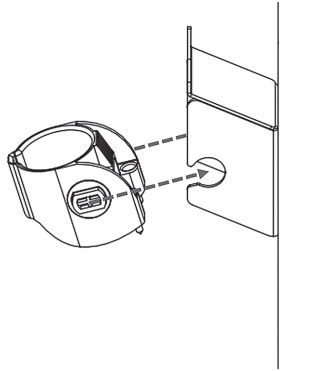

Secure the holster

4.6.4 Rotate the holster fully into the down position.

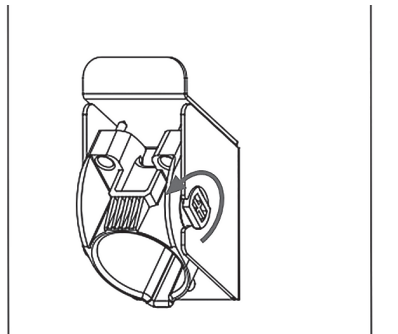

Rotate the holster

4.6.5 Keep the holster in this state and tighten the screws completely.

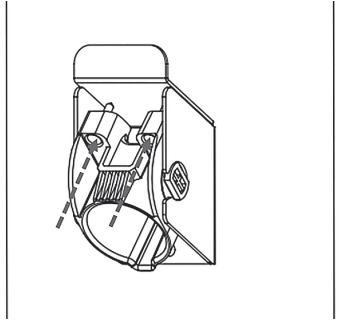

Lock screws

4.6.6 Place the EV charging plug in the holster.

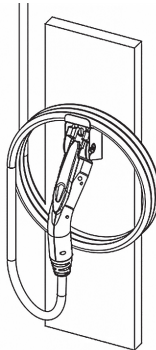

Holster the EV charging plug







Please visit the official website for more information and video walkthroughs for installing your AC7L/AC7LC.

4.7 Gateway Installation

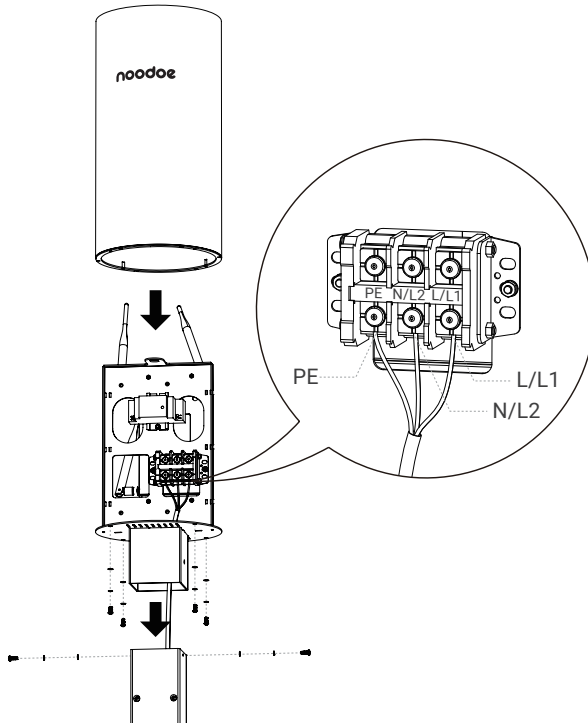
For consistent internet access, we recommended using the Noodoe EV Gateway G100 (please contact Noodoe to purchase).

4.7.1 Mounting on the pedestal



No.	Part	Name of Part	Unit
1		M4*12 Cross recessed binding head screws	2
2		M4 Plain washers	6
3		M4 Spring washers	6
4		M4x10 Hex Drive Screws	4

4.8 Gateway Installation Scenario

As different installation environments may affect connection quality, we highly recommend thorough consideration of the installation site layout prior to installation. The proper layout will help prevent suboptimal connection quality or disconnection issues.

Best receiving range: radius 18 m (60 feet).

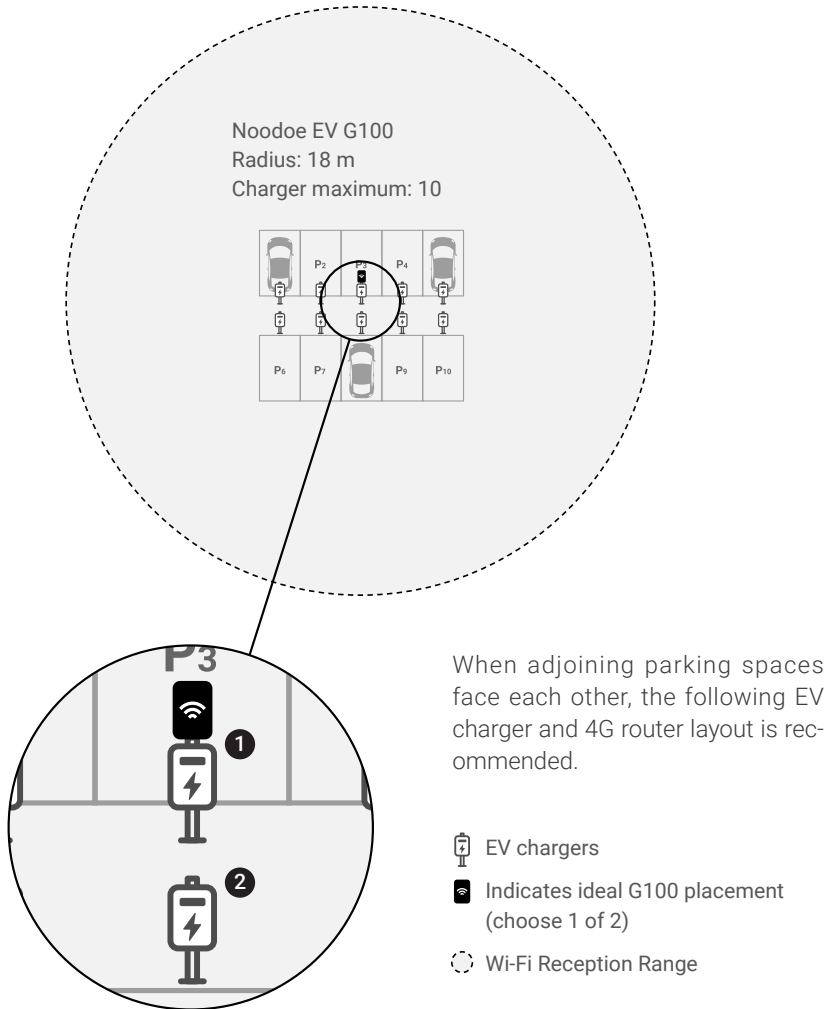

5. Getting Started

5.1 Setting up the local network

Step 1.

Connect a computer to the charge point using an Ethernet cable.



Location of the Ethernet RJ-45 port

Step 2.

Set up a dynamic IP Address on your computer. For Windows system, choose “Obtain an IP address automatically” in Internet Protocol Version 4 (TCP/IPv4) Properties dialog (as shown in the following figure).



5.1.2 Log In

Open a web browser (such as Internet Explorer) and enter the AC7L/AC7LC IP address. Please enter the text below in the address field of the browser and press enter.

http://192.168.199.1 If "Network Mode" is Gateway and "Group Use External Gateway" is No. or

http://192.168.100.1 for any other "Network Mode".

To be able to configure the charge point, you should enter "admin" as the user name. The default password is "howru2RU2IC3".

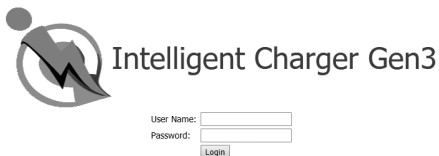

5.2 Web-page Overview

5.2.1 Menu Overview

To navigate via the web browser, use the menu items available: Configuration, Maintenance, EVSE Status, LLM Status, and Security.

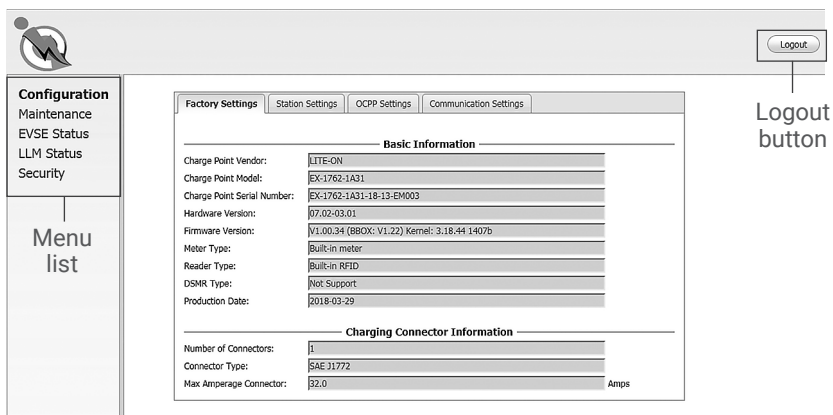

The screenshot displays the web interface of the Intelligent Charger Gen3. On the left side, there is a vertical menu with the following items: Configuration, Maintenance, EVSE Status, LLM Status, and Security. A "Menu list" label is positioned below the menu. On the right side, there is a "Logout" button. The main content area is titled "Factory Settings" and contains several tabs: Station Settings, OCPP Settings, and Communication Settings. The "Basic Information" section is expanded, showing the following details:

Basic Information	
Charge Point Vendor:	LITE-ON
Charge Point Model:	EX1762-1A31
Charge Point Serial Number:	EX1762-1A31-18-13-EM003
Hardware Version:	07-02-03.01
Firmware Version:	V1.00.34 (BBOX: V1.22) Kernel: 3.18.44-1407b
Meter Type:	Built-in meter
Reader Type:	Built-in RFID
DSMR Type:	Not Support
Production Date:	2018-03-29

The "Charging Connector Information" section is also expanded, showing the following details:

Charging Connector Information	
Number of Connectors:	1
Connector Type:	SAE J1772
Max. Amperage Connector:	32.0 Amps

5.2.2 Configuration Menu

When you choose the **Configuration** menu, a sub menu will appear:

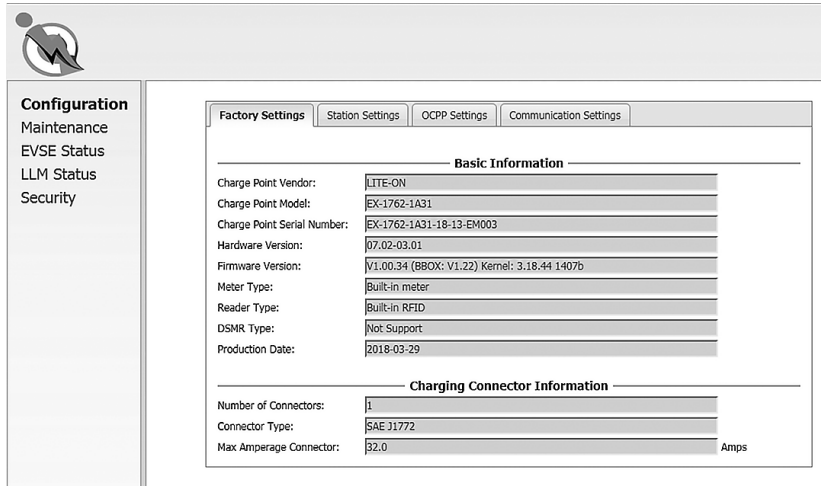

The screenshot displays a web interface for configuration. On the left is a sidebar menu with the following items: Configuration, Maintenance, EVSE Status, LLM Status, and Security. The main content area has a top navigation bar with four tabs: Factory Settings (selected), Station Settings, OCPP Settings, and Communication Settings. Below the tabs, the 'Basic Information' section contains the following data:

Charge Point Vendor:	LITE-ON
Charge Point Model:	EX-1762-1A31
Charge Point Serial Number:	EX-1762-1A31-18-13-EM003
Hardware Version:	07.02-03.01
Firmware Version:	V1.00.34 (BBOX: V1.22) Kernel: 3.18.44 1407b
Meter Type:	Built-in meter
Reader Type:	Built-in RFID
DSMR Type:	Not Support
Production Date:	2018-03-29

Below this is the 'Charging Connector Information' section:

Number of Connectors:	1
Connector Type:	SAE J1772
Max Amperage Connector:	32.0 Amps

- The **“Factory Settings”** tab is used to display the information of the charge point.
- The **“Station Settings”** tab is used to set up the configuration of the charge point itself.
- The **“OCPP Settings”** tab is used to set up the custom properties for uses in OCPP 1.6 services.
- The **“Communication Settings”** tab is used to set up the network connection and load management.

5.2.3 Maintenance Menu

When you choose the **Maintenance** menu, a sub menu will appear:

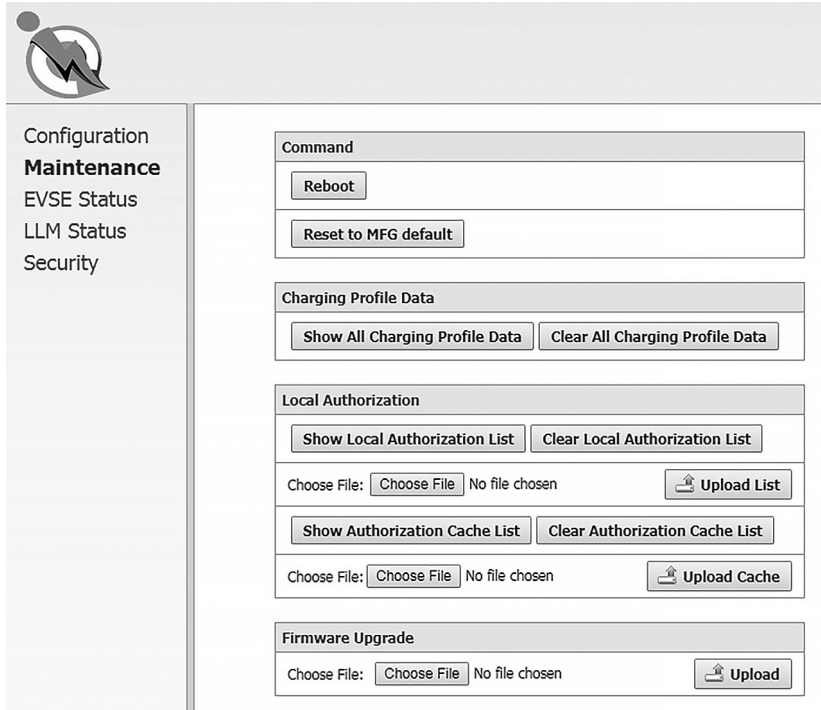

The screenshot shows a web interface for the Maintenance Menu. On the left is a navigation sidebar with a circular refresh icon at the top. The sidebar contains the following menu items: Configuration, **Maintenance** (highlighted), EVSE Status, LLM Status, and Security. The main content area is divided into four sections, each with a title bar and a list of buttons:

- Command**: Reboot, Reset to MFG default
- Charging Profile Data**: Show All Charging Profile Data, Clear All Charging Profile Data
- Local Authorization**: Show Local Authorization List, Clear Local Authorization List, Choose File: Choose File | No file chosen | Upload List, Show Authorization Cache List, Clear Authorization Cache List, Choose File: Choose File | No file chosen | Upload Cache
- Firmware Upgrade**: Choose File: Choose File | No file chosen | Upload

- The **“Command”** screen can be used to restart the charge point and reset settings to their Manufacturing default.
- The **“Charging Profile Data”** screen can be used to show and clear charging profiles including “Charge Point Max Profile”, “Tx Default Profile” and “Tx Profile”. Charging Profile is defined in OCPP 1.6 specification.
- The **“Local Authorization”** screen can be used to display and clear the Local Authorization List and Authorization Cache List. Both lists are defined in OCPP 1.6 specification.
- The **“Firmware Upgrade”** screen can be used to upgrade the charge point's firmware.

5.2.4 EVSE Status

When you choose the **EVSE Status** menu, a sub menu will appear:

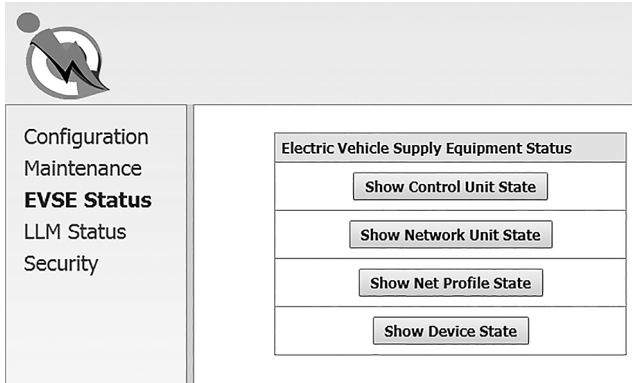

- The **“Electric Vehicle Supply Equipment Status”** can be used to show the EVSE information. This information is typically only for diagnostic use.

5.2.5 LLM Status Menu

When you choose the **LLM Status** menu, a sub menu will appear:

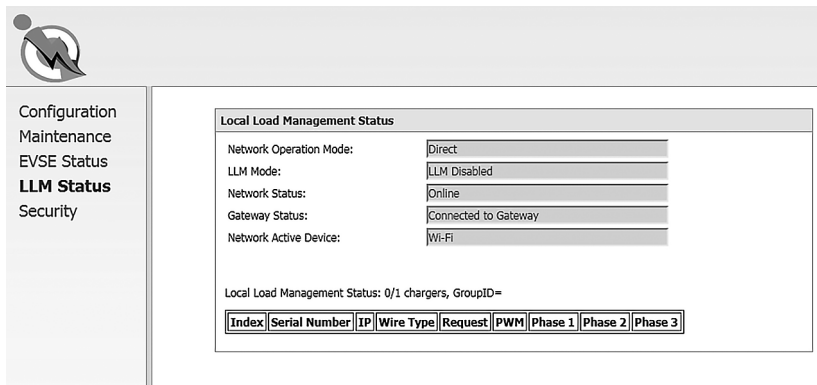

- The **“Local Load Management Status”** screen shows the Local Load Management (LLM) settings and current Master/Slave group member list.

5.2.6 Security Menu

When you choose the **Security** menu, a sub menu will appear:

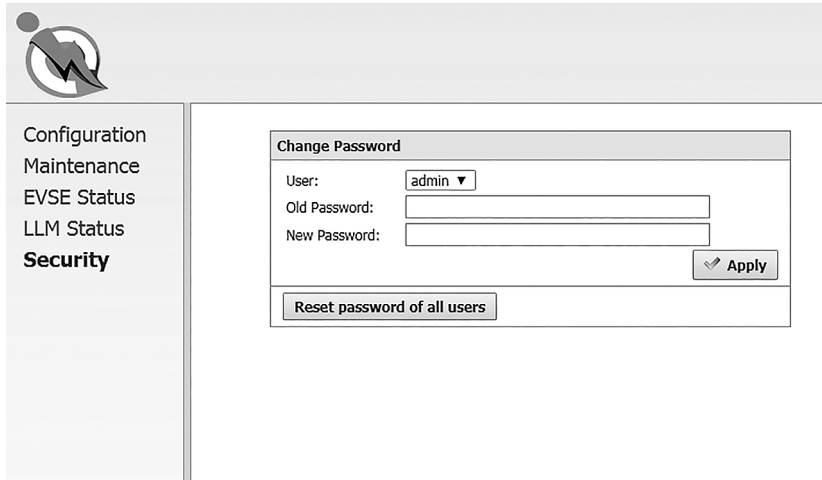

The screenshot shows a web interface with a sidebar menu on the left and a main content area on the right. The sidebar menu includes the following items: Configuration, Maintenance, EVSE Status, LLM Status, and Security (which is highlighted). The main content area displays a 'Change Password' form. The form has a title bar 'Change Password' and contains the following fields: 'User:' with a dropdown menu showing 'admin', 'Old Password:' with a text input field, and 'New Password:' with a text input field. There is an 'Apply' button with a checkmark icon to the right of the 'New Password' field. Below the form is a button labeled 'Reset password of all users'.

- The **“Change Password”** screen can be used to change the passwords for users of this web portal.

5.3 Configuration

5.3.1 Factory settings

Clicking on the **“Configuration”** and then **“Factory Settings”** link will bring up the following screen:

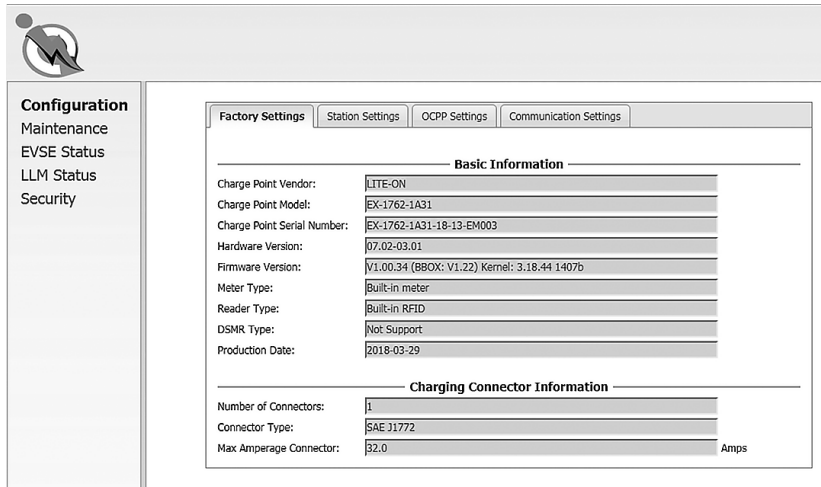

The screenshot shows a web interface for configuring a charge point. On the left is a sidebar with a navigation menu containing 'Configuration', 'Maintenance', 'EVSE Status', 'LLM Status', and 'Security'. The 'Configuration' option is highlighted. The main content area has four tabs: 'Factory Settings', 'Station Settings', 'OCPP Settings', and 'Communication Settings'. The 'Factory Settings' tab is selected, displaying two sections: 'Basic Information' and 'Charging Connector Information'. Each section contains a list of configuration items with their current values.

Basic Information	
Charge Point Vendor:	LITE-ON
Charge Point Model:	EX-1762-1A31
Charge Point Serial Number:	EX-1762-1A31-18-13-EM003
Hardware Version:	07.02-03.01
Firmware Version:	V1.00.34 (BBOX: V1.Z2) Kernel: 3.18.44 1407b
Meter Type:	Built-in meter
Reader Type:	Built-in RFID
DSMR Type:	Not Support
Production Date:	2018-03-29

Charging Connector Information	
Number of Connectors:	1
Connector Type:	SAE J1772
Max Amperage Connector:	32.0 Amps

Basic Information

- Charge Point Vendor – The name of the charge point vendor.
- Charge Point Model – The charge point model name.
- Charge Point Serial Number – The unique serial number of the charge point.
- Hardware Version – The hardware version of the charge point.
- Firmware Version – The software version of the charge point.
- Meter Type – The meter type of the charge point.
- Reader Type – The reader type of the charge point. (AC7LC only)
- DSMR Type – The DSMR type of the charge point.
- Production Date – The unit's production date.

Charging Connector Information

- **Number of Connectors** – Number of connectors of the charge point.
- **Connector Type*** – Indicates type 1 or type 2 cable installed on the charge point.
- **Max Amperage Connector** – The maximum charging current of the connector capability.

* A charge point may have multiple connectors installed. For AC7L/AC7LC series, there is only one connector on them.

5.3.2 Station Settings

Clicking on the **“Configuration”** and then **“Station Settings”** link will bring up the following screen. Since the page is too long to display, it is shown here as 2 screens.

On this page you can change the properties of the charge point. Click the **“Apply”** button to the right side of the property when the value has been changed.

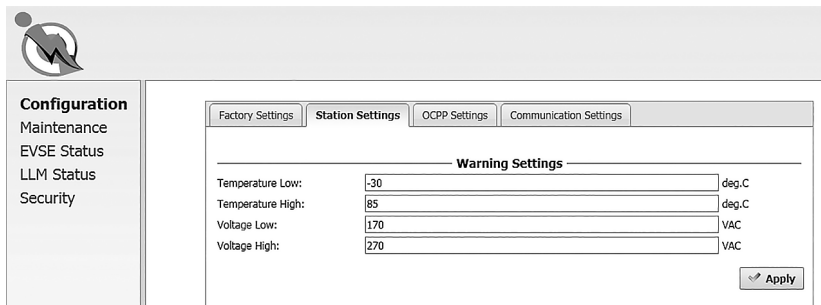

The screenshot shows a web interface for station settings. On the left is a navigation menu with 'Configuration' selected. The main area has tabs for 'Factory Settings', 'Station Settings', 'OCPP Settings', and 'Communication Settings'. Under 'Station Settings', there is a 'Warning Settings' section with four input fields: 'Temperature Low' (value: -30, unit: deg.C), 'Temperature High' (value: 85, unit: deg.C), 'Voltage Low' (value: 170, unit: VAC), and 'Voltage High' (value: 270, unit: VAC). An 'Apply' button is located at the bottom right of the settings area.

Warning Settings

- **Temperature Low** – Value in Celsius at which the charge point will send a temperature low warning message.
- **Temperature High** – Value in Celsius at which the charge point will send a temperature high warning message.
- **Voltage Low** – Value at which the charge point will send an under voltage warning message.
- **Voltage High** – Value at which the charge point will send an over voltage warning message.



Configuration Maintenance EVSE Status LLM Status Security	General Settings	
	Output Power Type:	AC
	Power Phase Connected:	1
	Max Amperage HW Setting:	32.0 Amps
	Max Amperage FW Setting:	32.0 Amps
	PWM Amperage:	0.00 Amps
	Real Amperage:	0.00 Amps
	Cold Load Pickup Max Delay:	720 Seconds
	Plug and Charge ID:	
	Reservation Supported:	Yes ▾
	Resume Charge After Reboot:	Off ▾
	RFID Reader:	On ▾
Ventilation Required:	No ▾	
Skip HeartBeat Message:	Yes ▾	
<input type="button" value="Apply"/>		

General Settings

- **Output Power Type** – AC or DC output power. For AC7L/AC7LC series, this value is always “AC”.
- **Power Phase Connected** – Input power phase connected to the charge point to indicate single phase or three phases. For AC7L/AC7LC series, this value is always “1”.
- **Max Amperage HW Setting** – The DIP switches (Hardware) settings to indicate the maximum charging current.
- **Max Amperage FW Setting** – The software settings to indicate the maximum charging current.
- **PWM Amperage** – The PWM setting for charging current when the charge point is online. This signal is used to tell an EV how much current it is allowed to use.
- **Real Amperage** – The real-time charging current detected by the charge point.
- **Cold Load Pickup Max Delay** – Default cold load pickup delay is 120s ~ 720s. The max value could be changed here.
- **Plug and Charge ID** – If the value is present, the charge point needs to support a plug and charge scenario by using the specific identifier. If absent, authorization for each session is required. This ID must be 8 or more characters.

- **Reservation Supported** – If true, the charge point will support reservation related messages from the Central System.
- **Resume Charge After Reboot** – Indicates whether the charge point resumes charging after power recycle. If true, the charge point will resume charging according to UL regulations. If false, the charge point will not resume charging.
- **RFID Reader** – Indicated whether an RFID reader is available. (AC7LC only)
- **Ventilation Required** – Indicates whether ventilation equipment is required. If this option is set to yes, a ventilation fault will occur when the EV report for need ventilation equipment. Recommended setup values are shown below according to the place and ventilation equipment available.

Place	Ventilation Equipment Available	Ventilation Equipment Not Available
Indoor	16 kgf.cm	Yes
Outdoor	No	No

- **Skip HeartBeat Message** – Indicate if HeartBeat message is skipped if any other message is sent successfully during a heartbeat interval.

Other Information	
Last Boot Time:	2018-05-05 14:08:45 UTC

Other Information

- **Last Boot Time** – Shows the last boot time.

5.3.3 OCPP Settings

Clicking on the “**Configuration**” and then “**OCPP Settings**” link will bring up the following screen. As the page is too long to display, please use the scrollbar to check remaining pages.

The screenshot shows a web interface for configuring OCPP settings. On the left is a navigation menu with options: Configuration, Maintenance, EVSE Status, LLM Status, and Security. The main content area has tabs for Factory Settings, Station Settings, OCPP Settings (selected), and Communication Settings. Under OCPP Settings, there are two sections: Remote Control Settings and Service Settings. Remote Control Settings includes a dropdown for Remote Control Type (OCPP) and an Apply button. Service Settings includes fields for Charge Point ID, Protocol Name, Central System URL, Basic Auth ID, Basic Auth Password, FTP Server Username, FTP Server Password, Message Transport Layer (WS), Boot Notification Interval (900 Seconds), Boot Notification Retries (-1), PDU Timeout (30 Seconds), Download Firmware Interval (300 Seconds), Download Firmware Retries (3), Upload Diagnostic Interval (300 Seconds), and Upload Diagnostic Retries (3). Each field has an Apply button.

On this page you can change the properties just for the charge point. Click the “Apply” button at the right side of the property when the value has been changed.

Remote Control Settings

- **Remote Control Type:** The remote control mode options are
 1. APP: Can be remotely controlled by mobile APP.
 2. OCPP: Can be remotely controlled by OCPP 1.6 protocol.

Service Settings

- **Charge Point ID** – The identity of the charge point as known in the OCPP Central System.
- **Protocol Name** – The name and version of OCPP running on the charge point.
- **Central System URL** – The URL of the OCPP v1.6 Central System service.
- **Basic Auth ID** – The ID for BASIC authentication in HTTPS (SSL/TLS) connections.
- **Basic Auth Password** – The password for BASIC authentication in HTTPS (SSL/TLS) connections.
- **FTP Server Username** – The username of the FTP Server for OCPP to download firmware files and upload diagnostic files.
- **FTP Server Password** – The password of the FTP Server for OCPP to download firmware files and upload diagnostic files.
- **Message Transport Layer** – Select the transport layer of the OCPP service that will be used. For AC7LC, the available options are **WS and WSS**.
 1. WS: Connection from charge point to OCPP Server uses WebSocket protocol.
 2. WSS: Connection from charge point to OCPP Server uses Secure WebSocket protocol.
- **Boot Notification Interval** – Interval of re-sending BootNotification.req if not accepted by Central System.
- **Boot Notification Retries** – Number of times to retry sending BootNotification.req.
 1. “-1” means unlimited
 2. “0” means don’t retry.
- **PDU Timeout** – Interval until the charge point stops waiting for a PDU response.
- **Download Firmware Interval** – Interval for downloading firmware from Central System.
- **Download Firmware Retries** – Number of times to retry downloading firmware.
- **Upload Diagnostics Interval** – Interval for uploading diagnostic file to Central System.

- **Upload Diagnostics Retries** – Number of times to retry uploading diagnostic files.

Unit Price:	<input type="text" value="3.5"/>	\$/kWh
Idle fee:	<input type="text" value="1.5"/>	\$/min
Idle fee after charging:	<input type="text" value="2.5"/>	\$/min
Initiation fee:	<input type="text" value="2"/>	\$
Custom Display CostAndPrice:	<input type="text" value="Disable"/>	

- **Unit Price** – Configure Unit Charging Price by \$/kWh. If this field is filled with a value not equal to 0, Unit Price will be displayed in OLED as follows:

```

A V A I L A B L E
3 . 5 0 0 $ / k W h

```

Setting this field to 0 will disable it in OLED display. By Default, this value is 0.

- **Idle fee** – Configure the Unit Idle fee before charging by \$/min. If this field is filled with a value not equal to 0, the Idle fee will be displayed in OLED as follows:

```

A V A I L A B L E
I D L E 1 1 . 5 0 0 $ / m i n

```

Setting this field to 0 will disable it in OLED display. By Default, this value is 0.

- **Idle fee after charging** – Configure Unit Idle fee after charging by \$/min. If this field is filled with a value not equal to 0, the Idle fee will be displayed in OLED as followings:

```

A V A I L A B L E
I D L E 2 2 . 5 0 0 $ / m i n

```

Setting this field to 0 will disable it in OLED display. By Default, this value is 0.

- **Initiation fee** – Configure the Initiation fee by \$. If this field is filled with a value not equal to 0, the Idle fee will be displayed in OLED as followings:

```

A V A I L A B L E
I n i t $ 2 . 0 0 0

```

Setting this field to 0 will disable it in OLED display. By Default, this value is 0.





Configuration Maintenance EVSE Status LLM Status Security	OCPP1.6 Settings	
	AllowOfflineTxForUnknownId:	Yes ▾
	AuthorizationCacheEnabled:	Yes ▾
	AuthorizeRemoteTxRequests:	No ▾
	BlinkRepeat:	30 Times
	ClockAlignedDataInterval:	900 Seconds
	ConnectionTimeOut:	120 Seconds
	GetConfigurationMaxKeys:	100
	HeartBeatInterval:	43200 Seconds
	LightIntensity:	100 %
	LocalAuthorizeOffline:	Yes ▾
	LocalPreAuthorize:	Yes ▾
	MaxEnergyOnInvalidId:	7360 Wh
	MeterValuesAlignedData:	Energy.Active.Import.Register ▾
	MeterValuesAlignedDataMaxLength:	10
MeterValuesSampledData:	Energy.Active.Import.Register ▾	
MeterValuesSampledDataMaxLength:	10	
MeterValueSampleInterval:	900 Seconds	
MinimumStatusDuration:	10 Seconds	
NumberOfConnectors:	1	
ResetRetries:	0 Times	
ConnectorPhaseRotation:	NotApplicable ▾	

OCPP1.6 Settings

- **AuthorizeRemoteTxRequests** – Whether a remote request to start a transaction in the form of a RemoteStartTransaction.req message should be authorized beforehand like a local action to start a transaction.
- **BlinkRepeat** – Number of times to blink the charge point lighting when signaling. This value is not changeable for AC7L/AC7LC.
- **ClockAlignedDataInterval** – Length (in seconds) of the clock-aligned data interval. This is the length (in seconds) of the set of evenly spaced aggregation intervals per day, starting at 00:00:00 (midnight).
- **ConnectionTimeOut** – Interval until incipient charging session is automatically canceled due to failure of EV user to insert the charging cable connector(s) into the appropriate connector(s).
- **GetConfigurationMaxKeys** – Maximum number of requested configuration keys in a GetConfiguration.req PDU.
- **HeartBeatInterval** – Defines the heartbeat interval.
- **LightIntensity** – Percentage of maximum intensity at which to illuminate the charge point lighting. This value is not changeable for AC7L/AC7LC.

- **LocalAuthorizeOffline** – Whether the charge point, when offline, will start a transaction for locally authorized identifiers.
- **LocalPreAuthorize** – Whether the charge point, when online, will start a transaction for locally authorized identifiers without waiting for or requesting an Authorize.conf from Central System.
- **MaxEnergyOnInvalidId** – Maximum energy in Watt-hour (Wh) delivered when an identifier is invalidated by Central System after the start of a transaction.
- **MeterValuesAlignedData** – Clock-aligned measurements to be included in a MeterValues.req PDU, every ClockAlignedDataInterval seconds. Supported values are Current, Import, Energy.Active.Import.Register, Temperature, Voltage, or any combination of these 4 values.
- **MeterValuesAlignedDataMaxLength** – Maximum number of items in a MeterValuesAlignedData configuration key.
- **MeterValuesSampledData** – Sampled measurands to be included in a MeterValues.req PDU, every MeterValueSampleInterval seconds. Supported values are Current.Import, Energy.Active.Import.Register, Temperature, Voltage, or any combination of these 4 values.
- **MeterValuesSampledDataMaxLength** – Maximum number of items in a MeterValuesSampledData configuration key.
- **MeterValueSampleInterval** – Interval between sampling of metering (or other) data, intended to be transmitted by “MeterValues” PDUs
- **MinimumStatusDuration** – The minimum duration that a charge point or connector status is stable before a StatusNotification.req PDU is sent to Central System.
- **NumberOfConnectors** – The number of physical charging connectors of this charge point.
- **ResetRetries** – Number of times to retry an unsuccessful reset of the charge point.
- **ConnectorPhaseRotation** – The phase rotation per connector in respect to the connector’s energy meter. This is not supported by AC7L/AC7LC since it is single phase power input. The value will always be ‘NotApplicable’.



Configuration Maintenance EVSE Status LLM Status Security	ConnectorPhaseRotationMaxLength:	1
	StopTransactionOnEVSideDisconnect:	Yes ▾
	StopTransactionOnInvalidId:	Yes ▾
	StopTxnAlignedData:	Current.Import,Energy.Active.Import.Register,Temperature,Voltz ▾
	StopTxnAlignedDataMaxLength:	10
	StopTxnSampledData:	Current.Import,Energy.Active.Import.Register,Temperature,Voltz ▾
	StopTxnSampledDataMaxLength:	10
	SupportedFeatureProfiles:	Core,Firmware Management,Local Auth List Management,Reservati
	SupportedFeatureProfilesMaxLength:	5
	TransactionMessageAttempts:	10 Times
	TransactionMessageRetryInterval:	10 Seconds
	UnlockConnectorOnEVSideDisconnect:	Yes ▾
	WebSocketPingInterval:	900 Seconds
	LocalAuthListEnabled:	Yes ▾
	LocalAuthListMaxLength:	100
	SendLocalListMaxLength:	100
	ReserveConnectorZeroSupported:	Yes ▾
	ChargeProfileMaxStackLevel:	99
ChargingScheduleAllowedChargingRateUnit:	Current	
ChargingScheduleMaxPeriods:	32	
ConnectorSwitch3to1PhaseSupported:	No ▾	
MaxChargingProfilesInstalled:	10	
		

- **ConnectorPhaseRotationMaxLength** – Maximum number of items in a ConnectorPhaseRotation configuration key.
- **StopTransactionOnEVSideDisconnect** – When set to true, the charge point SHALL administratively stop the transaction when the cable is unplugged from the EV.
- **StopTransactionOnInvalidId** – Whether the charge point will stop an ongoing transaction when it receives a non-accepted authorization status in a StartTransaction.conf for this transaction.
- **StopTxnAlignedData** – Clock-aligned periodic measurand(s) to be included in the TransactionData element of StopTransaction.req MeterValues.req PDU for every ClockAlignedDataInterval of the charging session. Supported value are Current.Import, Energy.Active.Import.Register, and Temperature, Voltage or any combination of these 4 value.
- **StopTxnAlignedDataMaxLength** – Maximum number of items in a StopTxnAlignedData configuration key.

- **StopTxnSampledData** – Sampled measurands to be included in the TransactionData element of StopTransaction.req PDU, every MeterValueSampleInterval seconds from the start of the charging session. Supported values are Current.Import, Energy.Active.Import.Register, Temperature, Voltage or any combination of these 4 values.
- **StopTxnSampledDataMaxLength** – Maximum number of items in a StopTxnSampledData configuration key.
- **SupportedFeatureProfiles** – A list of supported Feature Profiles. Possible profile identifiers: Core, FirmwareManagement, LocalAuthListManagement, Reservation, SmartCharging and RemoteTrigger.
- **SupportedFeatureProfilesMaxLength** – Maximum number of items in a SupportedFeatureProfiles configuration key.
- **TransactionMessageAttempts** – How often the charge point should try to submit a transaction-related message when Central System fails to process it.
- **TransactionMessageRetryInterval** – How long the charge point should wait before resubmitting a transaction-related message that Central System failed to process.
- **UnlockConnectorOnEVSideDisconnect** – When set to true, the charge point SHALL unlock the cable on the charge point side when the cable is unplugged at the EV. This is not supported by AC7L/AC7LC since it is plug type and has no connector lock.
- **WebSocket Ping Interval** – Define the ping pong interval for WebSocket protocol.
- **LocalAuthListEnabled** – Whether the Local Authorization List is enabled.
- **LocalAuthListMaxLength** – Maximum number of identifications that can be stored in the Local Authorization List.
- **SendLocalListMaxLength** – Maximum number of identifications that can be sent in a single SendLocalList.req.
- **ReserveConnectorZeroSupported** – If this configuration key is present and set to true: The charge point supports reservations on connector 0.
- **ChargeProfileMaxStackLevel** – Max Stack Level of a Charging Profile. The number defined also indicates the max allowed number of installed charging schedules per Charging Profile purposes.

- **ChargingScheduleAllowedChargingRateUnit** – A list of supported quantities for use in a Charging Schedule. This value will always be 'Current' for AC7L/AC7LC.
- **ChargingScheduleMaxPeriods** – Maximum number of periods that may be defined per Charging Schedule.
- **ConnectorSwitch3to1PhaseSupported** – If defined and true, this charge point supports switching from 3 to 1 phase during a charging session. This is not supported by AC7L/AC7LC since it is single phase power input.
- **MaxChargingProfilesInstalled** – Maximum number of charging profiles installed at a time.

5.3.4 Communication Settings

Clicking on the **“Configuration”** and then **“Communication Settings”** link will bring up the following screen. Since the page is too long to display, it is here separated into multiple screen.

On this page you can set up the network connection. To finish, click the **“Apply”** button.

The screenshot shows the 'Communication Settings' configuration page. The sidebar on the left contains the following menu items: Configuration, Maintenance, EVSE Status, and LLM Status. The main content area has four tabs: Factory Settings, Station Settings, OCPP Settings, and Communication Settings. The 'Communication Settings' tab is selected and displays the following configuration options:

- Network Mode*: Direct (dropdown)
- Gateway LAN IP: 192.168.199.1 (text input)
- Gateway LAN Port (SOAP): 8080 (text input)
- Max Group Size: 12 (text input)
- Gateway Serial Number: (text input)
- Group Use External Gateway*: No (dropdown)
- Hide AP SSID: Off (dropdown)
- Connectivity: Wi-Fi (dropdown)
- LED Brightness: 20% (dropdown)

Below these settings are two sections:

- Active Device Status**:
 - Active Device: Wi-Fi (text input)
 - Active IP Address: 192.168.0.18 (text input)
 - Active Netmask: 255.255.255.0 (text input)
 - Active Gateway: 192.168.0.1 (text input)
 - Active Primary DNS: (text input)
 - Active Secondary DNS: (text input)
- Wi-Fi Settings**: (partially visible)

- **Network Mode** – Specifies if the Local Proxy function has been enabled. Available options are Gateway, Client and Direct.
 1. Direct: Use the charge point as a single device.
 2. Gateway: Use the charge point as a gateway charge point. When the Gateway is connected to OCPP 1.6 Server via cellular or Wi-Fi and connected to other charge points (called Clients) via Wi-Fi, it will form and forms a local group of charge points. This group is also a LAN (Local Area Network).
 3. Client: Use the charge point as a client charge point. Connect the Client connected to Gateway via Wi-Fi. If the Client is connected to OCPP1.6 Server through gateway charge point (via cellular or Wi-Fi), Gateway will dispatch incoming remote command to proper client charge points (or Gateway itself).

* Note: Network mode is used to change how a group of AC7L/AC7LC connect to the internet. If a charge point's network mode is Client, then there must be a Gateway (AC7LC) in this group, and all client charge points will connect to the internet via Gateway. These chargers form a Gateway/Client group. In this group, there is exact one Gateway. All other charge points are Clients.

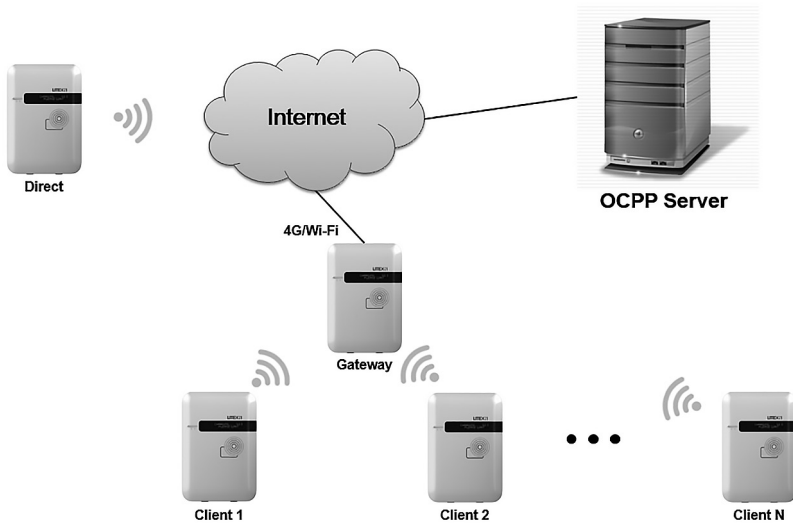

- **Gateway LAN IP** – The IP of the LAN master. This value cannot be modified by users.
- **Gateway LAN Port (SOAP)** – The listen port for OCPP SOAP client server. This value cannot be modified by users.
- **Max Group Size** – The maximum number of charge points allowed in a group/LAN. This value cannot be modified by users. Group sizes are limited to 20.
- **Gateway Serial Number** – The serial number of the charge point which acts as a Gateway.
- **Group Use External Gateway** – Gateway/Client mode use external gateway as a local network group or not (use Gateway AC7LC).

* Note: A Gateway charge point can use either Wi-Fi or Cellular to connect to the internet. Change this under the 'Group Use External Gateway' setting. If set to No, a Gateway will use Cellular, or it will use Wi-Fi. When this setting is changed, the 'Connectivity' option will automatically change as well.

All charge point in this Gateway/Client group must have the same 'Group Use External Gateway' setting, i.e. all charge points must set this option to Yes (including Gateway and Client) when using an external Wi-Fi AP to connect to internet. In this case, all charge points must also use the same Wi-Fi settings (SSID, password) for the external Wi-Fi AP.

- **Hide AP SSID** – Options for whether to hide the SSID of the charge point. For AC7L/AC7LC this option is always off.
- **Connectivity** – Specify whether the charge point should always be connected to the Internet using **None**, **Auto**, **Wi-Fi**, or **Cellular***. Default value is Auto. When Network Mode is Direct, all option are available. If it is not, then Connectivity will be set with the following rule:

Network Mode	Group Use External Gateway = Yes	Group Use External Gateway = No
Gateway	Wi-Fi	Cellular
Client	Wi-Fi Wi-Fi setting will be disabled and Client will setup Wi-Fi to connect to Gateway indicated by 'Gateway Serial Number'	Wi-Fi

* Note: Cellular: AC7LC support only

- **LED brightness** – The user can modify the LED brightness according to the user's environment and preferences. There are five settings: 20%, 40%, 60%, 80%, 100%. (Default setting is 20%)

Active Device Status

- **Active Device** – Current active network device. Possible values are None, Wi-Fi or Cellular
- **Active IP Address** – Current active IP address. There will be a value here only if connected to a network.
- **Active Netmask** – Current active netmask address. There will be a value here only if connected to a network.
- **Active Gateway** – Current active gateway IP address. There will be a value here only if connected to a network and network provides this data.
- **Active Primary DNS** – Current active primary DNS IP address. There will be a value here only if connected to a network and network provides this data.
- **Active Secondary DNS** – Current active secondary DNS IP address. There will be a value here only if connected to a network and network provides this data.

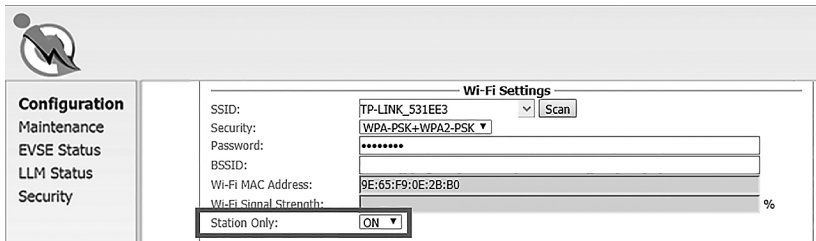

The image shows a screenshot of a device's configuration menu. On the left is a vertical sidebar with options: Configuration, Maintenance, EVSE Status, LLM Status, and Security. The 'Configuration' option is selected. The main area is titled 'Wi-Fi Settings' and contains the following fields:

- SSID: TP-LINK_531EE3 (with a Scan button)
- Security: WPA-PSK+WPA2-PSK (dropdown menu)
- Password: [Redacted with asterisks]
- BSSID: [Redacted]
- Wi-Fi MAC Address: 9E:65:F9:0E:2B:B0
- Wi-Fi Signal Strength: [Redacted] %
- Station Only: ON (dropdown menu)

Wi-Fi Settings

- **SSID** – The SSID name of the Wi-Fi Access Point. Press Scan to scan and receive current detectable Wi-Fi signals.
- **Security** – The encryption of the Wi-Fi Access Point. Options are None, WEP, WPA-PSK, WPA2-PSK, WPA-PSK+WPA2-PSK and Auto.
- **Password** – The password of the Wi-Fi Access Point.
- **BSSID** – The MAC Address of the Wi-Fi Access Point. If your Access Point is a hidden SSID, please enter this address.
- **Wi-Fi MAC Address** – Displays the Wi-Fi device hardware MAC address.
- **Wi-Fi Signal Strength** – Displays the strength of the wireless Wi-Fi signal in percentage (%).
- **Station Only** – If “Station Only” is ON, the charger will stay in station mode always. If “Station Only” is OFF, it will go into AP mode after 5 attempts to connect to the external Wi-Fi AP.

* Note: The **Station Only** option only works if the remote control type is OCPP. If the remote control type is APP – it retains its original behavior (retry 5 times and go to AP mode) no matter what Station Only option is selected.



Configuration
Maintenance
EVSE Status
LLM Status
Security

Cellular Settings

MNC:	
ICCID:	
IMSI:	
IMEI:	356278072420575
MEID:	356278072420575
Cellular APN:	
Cellular APN PDP Type:	IPv4v6 ▾
Cellular APN User:	
Cellular APN Password:	
Cellular Dial Number:	*99#
Cellular PIN Code:	
Primary DNS:	
Secondary DNS:	
Cellular Signal Strength:	
Cellular WAN IP Address:	
Port Forwarding:	Disable ▾
Port Range:	
Timeout RX:	3600

Cellular Settings (Support only on AC7LC)

- **MNC** – The Mobile Network Code of the cellular service provider. There will be no data here if there is no 3G/LTE signal.
- **ICCID** – The ICCID of the modem’s SIM card. There will be no data here if no SIM card is inserted.
- **IMSI** – The IMSI of the modem’s SIM card. There will be no data here if no SIM card is inserted.
- **IMEI** – The IMEI (International Mobile Equipment Identity) of the modem.
- **MEID** – The MEID (Mobile Equipment Identifier) of the modem.
- **Cellular APN** – This is the gateway for all cellular traffic. Contact your cellular operator for information about this. For AT&T and Verizon LTE service, just leave it blank since the apn name is built into in the modem.
- **Cellular APN PDP Type** – An option to select the PDP type for APN configuration. The default for the Cellular APN PDP Type is IPv4v6.
- **APN Username** – This is the user name your ISP has assigned to you (optional).
- **APN Password** – Password to log into the ISP network (optional).
- **Dial Number** – Phone number to dial for cellular network.
- **PIN Code** – PIN code for the modem’s SIM card (optional). 4 digit number.
- **Primary DNS** – The primary Domain Name Server (optional).
- **Secondary DNS** – The secondary Domain Name Server (optional).

- **Cellular Signal Strength** – The strength of cellular signal in dBm.
- **Cellular WAN IP Address** – IP address of the Cellular network.
- **Port Forwarding** – To redirect a communication request from one address and port number combination to another while the packets are traversing a network gateway.
- **Port Range** – A port number is a 16-bit unsigned integer ranging from 0 to 65535. Port range defines a range which can be used. The format for numeric port range is minimum-value:maximum-value.
- **Timeout RX** – Timeout limitation for signal received by the modem.

Local Load Management(LLM) Settings

Local Load Management™:

Charging Policy™:

Group ID:

Group Size:

Max Amperage Grid Connection: Amps

Fallback Current: Amps

Local Load Management (LLM) Settings (Support only on AC7LC)

Local load management is the process of balancing the supply of electricity on the network with the electrical load by adjusting or controlling the load of each charge point in a local group based on Gateway/Client architecture. The Gateway AC7LC must be manually set to the maximum current limitations so that it will dynamically adjust output current in each Client AC7LC according to charging policy.

When LLM function is on, all charge points will request charging from Gateway, and Gateway will calculate the proper current limit and reply to each Client. Each charge point will only allow charging once it receives a current limit from Gateway. If there is a disconnection between a Client and Gateway, then the Client will use a fallback value as the limitation.

- **Local Load Management** – Enable or disable Local Load Management function. This function can only be enabled in a Gateway or Client charge point.

HINT: If user changes the “Network Mode” setting, then related settings will also change automatically. This includes “Connectivity”, “Local Load Management”. The default value is as follows:

	Direct	Gateway	Client
Gateway LAN IP	Not used	Default value, not changeable	Not used
Gateway LAN Port	Not used	Default value, not changeable	Not used
Max Group Number	Not used	Default value, not changeable	Not used
Group Use External Gateway	Not used	Yes or No	Yes or No
Gateway Serial Number	Not used	Not used	Used
Connectivity	Auto	Wi-Fi or Cellular	Wi-Fi, not changeable
Local Load Management	Disabled, not changeable	Enable	Enable

- **Charging Policy** – The charging policy for LLM Gateway to decide the charging current for each charge point. Valid options are:

1. UD (default): Uniform Distribution. The maximum amperage is divided by total numbers of charging EV, i.e. each EV will use the same charging current.
2. FIFS: First In First Serve.

- **Group ID** – An identity of the LLM group. A slave with different group identity will be rejected when attempting to connect to Gateway.
- **Group Size** – The total number of charge points in the LLM group. This value is only used in Gateway.
- **Max Amperage Grid Connection** – Total ampere of each phase allowed loading for the group of charge points at the same time. This value is only used in Gateway.
- **Fallback Current** – The fallback current when Client is not able to communicate with Gateway. Gateway will overwrite fallback current in Client with its own value when Client connects to Gateway

* Note: Any option followed by an asterisk (*) means the setting requires a reboot to take effect. When these values are changed and applied, the web portal will display a reminder message box for rebooting the charge point.

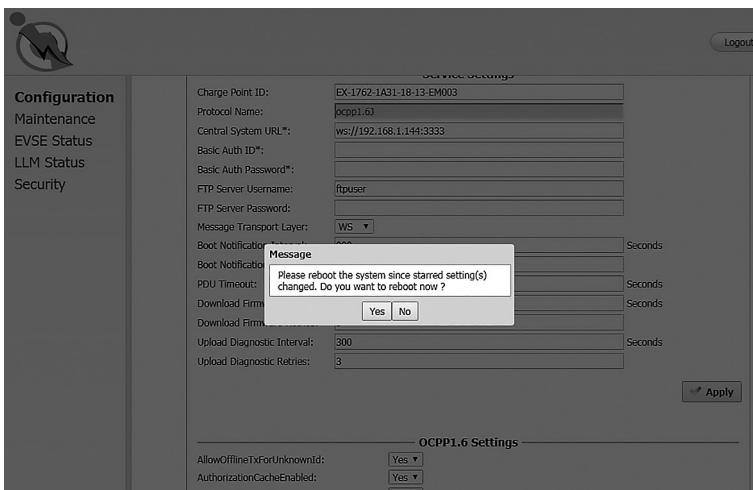

5.4 Maintenance

This page includes some maintenance functions.

5.4.1 Reboot

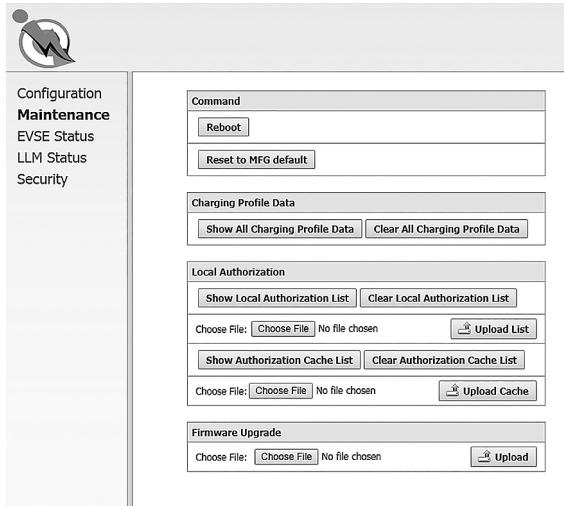

The screenshot shows a web interface for maintenance functions. On the left is a navigation menu with a 'Maintenance' icon and the following items: Configuration, Maintenance, EVSE Status, LLM Status, and Security. The main content area is divided into several sections:

- Command:** Contains buttons for 'Reboot' and 'Reset to MFG default'.
- Charging Profile Data:** Contains buttons for 'Show All Charging Profile Data' and 'Clear All Charging Profile Data'.
- Local Authorization:** Contains buttons for 'Show Local Authorization List' and 'Clear Local Authorization List'. Below these are two file upload sections, each with a 'Choose File' button, the text 'No file chosen', and an 'Upload List' button.
- Firmware Upgrade:** Contains a file upload section with a 'Choose File' button, the text 'No file chosen', and an 'Upload' button.

Command

- **Reboot:** To restart the charge point.
- **Reset to MFG default:** To reset to the factory default settings.

Charging Profile Data

HINT: Charging Profile is defined in OCPP 1.6 specification for smart charging. A charging profile consists of a charging schedule, which is basically a list of time intervals with their maximum charge power or current, and some values to specify the time period and recurrence of the schedule.

- **Show All Charging Profile Data:** To show the list of Charging Profiles. There will be a display window. The data display here is RAW data, usually for diagnostic use.
- **Clear All Charging Profile Data:** To clear all Charging Profile data.

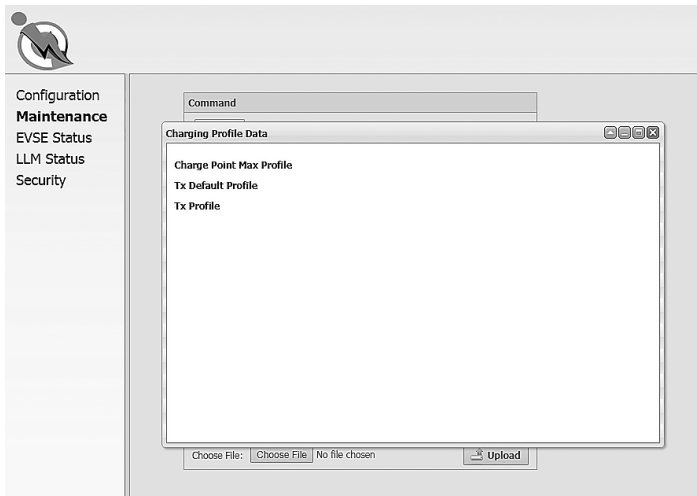

Local Authorization

- **Reboot:** To restart the charge point.
- **Reset to MFG default:** To reset to the factory default settings.

HINT: Local authorization is defined in OCPP 1.6 specification. There are two local list: Local Authorization List and Authorization Cache List. The Local Authorization List is a list of identifiers that can be synchronized with the Central System. An Authorization Cache autonomously maintains a record of previously presented identifiers that have been successfully authorized by the Central System.

- **Show Local Authorization List:** To show the list of Local Authorization. Each line of the list shown below indicates RFID card info. The syntax is

CARD_IDTAG|EXPIRY_DATE|PARENT_CARD_IDTAG|CARD_STATUS

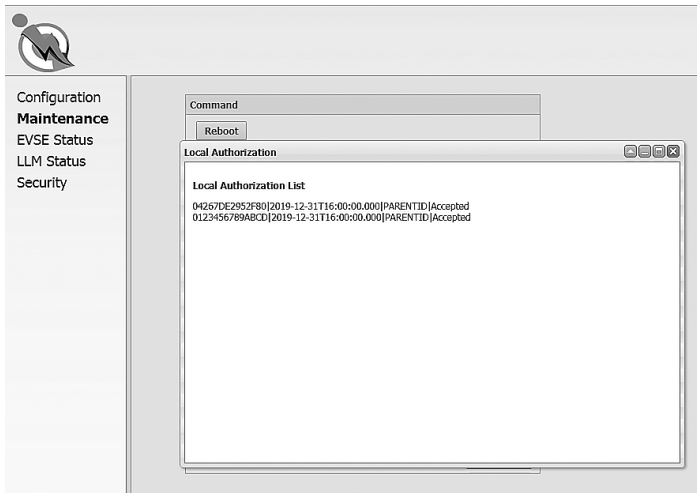

- **Clear Local Authorization List:** To clear the list of Local Authorization.
- **Upload List:** Upload a csv file that includes card info to Local Authorization List.

A csv file is a plain text file in which each line represents an RFID card's information. The format of a card info is as follow:

CARD_IDTAG,EXPIRY_DATE,PARENT_CARD_IDTAG,CARD_STATUS

CARD_IDTAG: 8 ~ 20 alphanumeric character RFID card ID tag.

EXPIRY_DATE: The date when the idTag should be removed from the Authorization Cache. Format is YYYY-MM-DDThh:mm:ss.ttt which indicates a date in AD. Example: 2019-12-31T16:00:00.000

PARENT_CARD_IDTAG: The parent-identifier of the card. The format is the same as CARD_IDTAG.

CARD_STATUS: This contains whether the idTag has been accepted or not by the Central System. Valid options are Accepted, Blocked, Expired or Invalid. This string is case sensitive.

Sample data: 0123456789ABCD,2019-12-31T16:00:00.000,PARENTID,Accepted

- **Show Authorization Cache List:** To show the list of the Authorization Cache. Each line of the list shown below indicates cached RFID card info. The syntax is

CARD_IDTAG|EXPIRY_DATE|PARENT_CARD_IDTAG|CARD_STATUS|
CACHED_DATE

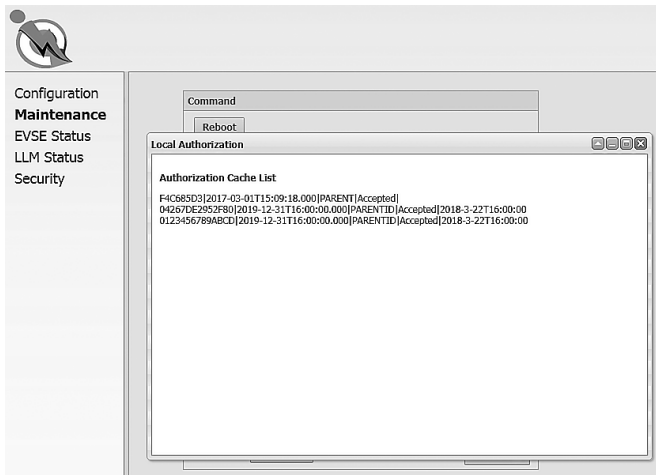

- **Clear Authorization Cache List:** To clear the Authorization Cache list.
- **Upload Cache:** Upload a csv file that includes cached card info to Authorization Cache List.

A csv file is a plain text file which each line represent a cached RFID card info. The format of a cached card info is as follow:

CARD_IDTAG,EXPIRY_DATE,PARENT_CARD_IDTAG,CARD_STATUS,-
CACHED_DATE

CARD_IDTAG: 8 ~ 20 alphanumeric character RFID card ID tag.

EXPIRY_DATE: The date when the idTag should be removed from the Authorization Cache. Format is YYYY-MM-DDThh:mm:ss.ttt which indicates a date in AD. Example: 2019-12-31T16:00:00.000

PARENT_CARD_IDTAG: the parent-identifier of the card. The format is the same as CARD_IDTAG.

CARD_STATUS: This contains whether the idTag has been accepted or not by the Central System. Valid options are Accepted, Blocked, Expired or Invalid. This string is case sensitive.

CACHED_DATE: The date when the idTag will be cached. The format is identical to EXPIRY_DATE.

Sample data: 0123456789ABCD,2019-12-31T16:00:00.000,PARENTID,Accepted,2018-3-22T16:00:00

5.4.2 Firmware Upgrade

To upgrade the firmware of the charge point, you need to download the upgrade image file to your local hard disk, and then click the “Choose File” button to locate the firmware file on your computer. Once you have selected the new firmware file, click the “Upload” button to start the upgrade process. After a successful upgrade, the web portal will be logged out and the charge point will reboot.

Although the web portal does not forbid uploading firmware of a previous version, the design of each firmware upgrade file includes all backward modifications. Downgrading the firmware may cause unpredicted problems and is not recommended.

5.5 EVSE Status

To check the specific information of EVSE, you can click the corresponding buttons:

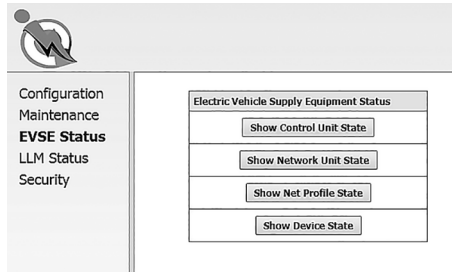

- **Show Control Unit State:** To display the information of the control unit of the charge point. These functions mostly relate to charging and safety.
- **Show Network Unit State:** To display the information of the network board of the charge point. These functions mostly relate to network connection and remote management.
- **Show Net Profile State:** To display the information of the network connectivity and settings of charge point.
- **Show Device State:** To display the information of the device service/connection between the charge point and OCPP server/network connectivity.

5.6 LLM Status

5.6.1 LLM information

This page shows the Local Load Management information for the charge point. For further description of LLM, please refer to section 5.3.4.

Configuration
Maintenance
EVSE Status
LLM Status
Security

Local Load Management Status

Network Operation Mode: Direct
LLM Mode: LLM Disabled
Network Status: Online
Gateway Status: Connected to Gateway
Network Active Device: Wi-Fi

Local Load Management Status: 0/1 chargers, GroupID=

Index	Serial Number	IP	Wire Type	Request	PWM	Phase 1	Phase 2	Phase 3
-------	---------------	----	-----------	---------	-----	---------	---------	---------

- **Network Operation Mode:** Indicates that the charge point is in Direct mode, a Gateway or a Client.
- **LLM Mode:** Indicates that the Local Load Management function is enabled or disabled.
- **Network Status:** Indicates whether the charge point is online.
- **Gateway Status:** Indicates whether the charge point is connected to the Gateway if it's a Client. For Direct and Gateway, it always shows "Connected to Gateway".
- **Network Active Device:** Indicates which device the network is connected through. It could be Offline, Wi-Fi or Cellular.
- **Local Load Management Status:** Display connected charge points, total charge points, Group ID of the LLM group, and a full table of detailed information for charge point if this charge point is Gateway.

5.6.2 LLM information

If the charge point is Gateway, the following LLM Group Table is present.

Index	Serial Number	IP	Wire Type	Request	PWM	Phase 1	Phase 2	Phase 3
1	04000023	192.168.199.62	L1 L2 L3	32.0	32.0	15.1	0.7	0.8
2(M)	04000080	10.81.19.91	L1 L2 L3	32.0	32.0	13.7	0.7	0.8
3	04000026	192.168.199.53	L3 L1 L2	0.0	0.0	0.0	0.0	0.0
4	04000046	192.168.199.50	L1 L2 L3	32.0	32.0	0.0	0.0	0.0
5	04000070	192.168.199.51	L3 L1 L2	32.0	32.0	0.0	0.0	0.0
6	04000092	192.168.199.57	L2 L1 L3	32.0	32.0	0.0	0.0	0.0
7	04000071	192.168.199.49	L2 L1 L3	0.0	0.0	0.0	0.0	0.0
8	04000090	192.168.199.48	L1 L2 L3	32.0	32.0	0.0	0.0	0.0
9	04000032	192.168.199.47	L3 L1 L2	0.0	0.0	0.0	0.0	0.0
10	04000050	192.168.199.52	L1 L2 L3	32.0	32.0	14.3	0.1	0.1
11	04000064	192.168.199.46	L2 L1 L3	32.0	32.0	0.5	15.7	0.3
12	04000024	192.168.199.58	L2 L1 L3	0.0	0.0	0.0	0.0	0.0
13	04000027	192.168.199.56	L2 L1 L3	32.0	32.0	0.5	15.0	0.5
14	04000020	192.168.199.54	L3 L1 L2	32.0	32.0	5.0	0.6	0.6
15	04000054	192.168.199.61	L3 L1 L2	32.0	32.0	14.4	0.7	0.7
16	04000036	192.168.199.63	L1 L2 L3	32.0	32.0	0.5	0.5	0.5
17	04000082	192.168.199.59	L3 L1 L2	0.0	0.0	0.0	0.0	0.0
18	04000049	192.168.199.64	L2 L1 L3	0.0	0.0	0.0	0.0	0.0
19	04000079	192.168.199.55	L1 L2 L3	32.0	32.0	0.0	0.0	0.0
20	04000076	192.168.199.60	L1 L2 L3	32.0	32.0	0.8	0.9	0.9

Total: Request: 448.0 A, PWM: 448.0 A, Phase1: 64.8 A, Phase2: 34.9 A, Phase3: 5.2 A

- **Index:** The order of the charge points. The first charge point shown is Gateway.
- **Serial Number:** The serial number (Charge Point Identity) of each charge point.
- **IP:** The private local IP address in the LLM group of each charge point.
- **Wire Type:** The power source wire type of each charge point.
- **Request:** The requested current of each charge point.
- **PWM:** The PWM (charger allowed) current of each charge point.
- **Phase 1, Phase 2, Phase 3:** The real current loaded by the vehicles of each charge point. For AC7LC, only Phase 1 has current.

5.6.3 Operation mode

There are two different operation modes: **Distribution mode** and **Priority mode**. Each time a new car is plugged-in and starts charging, the LLM gateway will re-calculate the proper ampere for each charging station.

Depending upon the operation mode, the algorithm is different.

Distribution mode (Uniform Distribution)

The available current is divided equally amongst all available charging stations.

Example 1

In this example, there are three (32 A) charging stations in the LLM group. Each charging station is set up according to the following settings:

Setting	Gateway	Client
Local Load Management	Enable	Enable
Charging Policy	Uniform Distribution	Not used
Group ID	LLM-Group-1	LLM-Group-1 (Same as Gateway)
Group Size	3	Not used
Max Amperage Grid Connection	60	Not used
Fallback Current	10	10 (Same as Gateway)

With one connected vehicle, the charging current is 32 A.

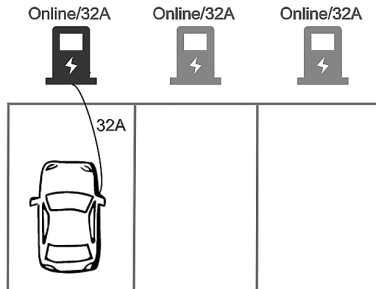

With two connected vehicles, the charging currents are evenly reduced to 30 A.

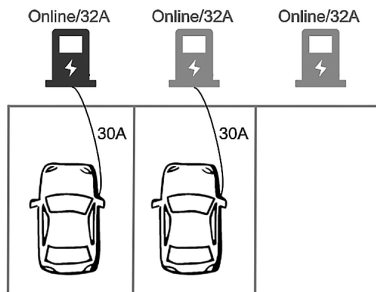

With three connected vehicles, the charging currents are further reduced to 20 A.

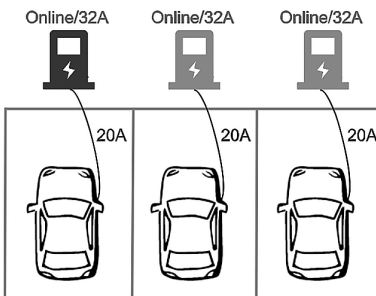

Example 2

In this example, there are two (32 A) charging stations and one (16 A) charging station in the LLM group. Each charging station is set up according to the following settings:

Setting	Gateway	Client
Local Load Management	Enable	Enable
Charging Policy	Uniform Distribution	Not used
Group ID	LLM-Group-1	LLM-Group-1 (Same as Gateway)
Group Size	3	Not used
Max Amperage Grid Connection	60	Not used
Fallback Current	10	10 (Same as Gateway)

With one connected vehicle, the charging current is 32 A.

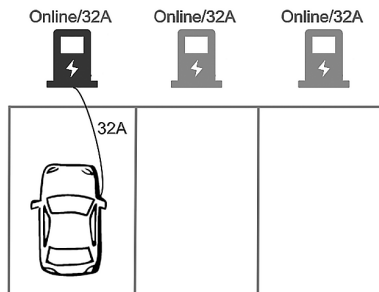

With two connected vehicles, the charging currents are evenly reduced to 30 A.

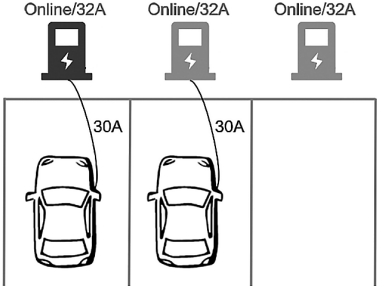

With three connected vehicles, the charging currents are further reduced to 24 A for the 32 A charging stations and 12 A for the 16 A charging station.

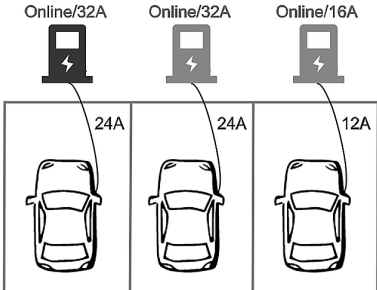

Example 3

In this example, there are five (32 A) charging stations in the LLM group, and two of the charging stations are offline. Each charging station is set up according to the following settings:

Setting	Gateway	Client
Local Load Management	Enable	Enable
Charging Policy	Uniform Distribution	Not used
Group ID	LLM-Group-1	LLM-Group-1 (Same as Gateway)
Group Size	5	Not used
Max Amperage Grid Connection	80	Not used
Fallback Current	10	10 (Same as Gateway)

With one connected vehicle, the charging current is 32 A. (Reserve 20 A for offline charging stations)

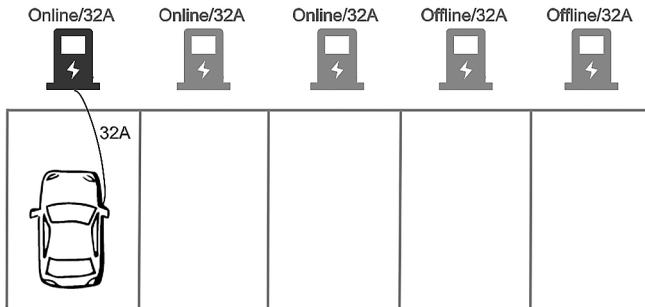

With two connected vehicles, the charging currents are evenly reduced to 30A. (Reserve 20A for offline charging stations)

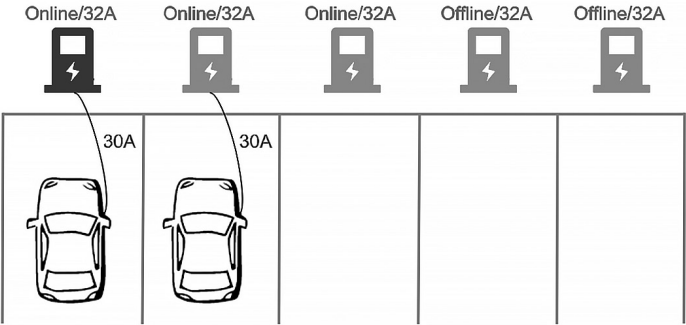

With three connected vehicles, the charging currents are further reduced to 20A. (Reserve 20A for offline charging stations)

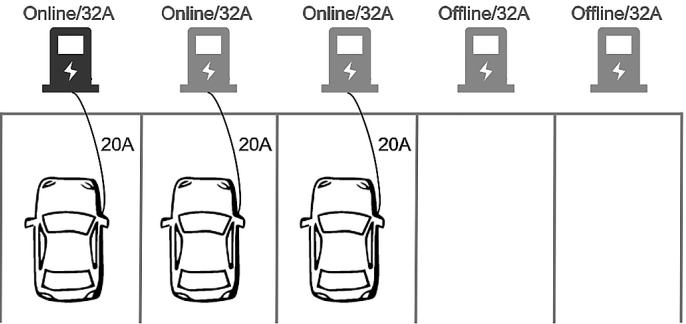

Priority mode (First Come First Serve)

The available current is NOT divided equally amongst all available charging stations. The first vehicle connected would be allocated as much as possible. If any current capacity is left, then the remainder would be given to the other charging stations.

Example 1

In this example, there are three (32 A) charging stations in the LLM group. Each charging station is set up according to the following settings:

Setting	Gateway	Client
Local Load Management	Enable	Enable
Charging Policy	First In First Serve	Not used
Group ID	LLM-Group-1	LLM-Group-1 (Same as Gateway)
Group Size	3	Not used
Max Amperage Grid Connection	60	Not used
Fallback Current	10	10 (Same as Gateway)

The first vehicle connected receives 32 A.

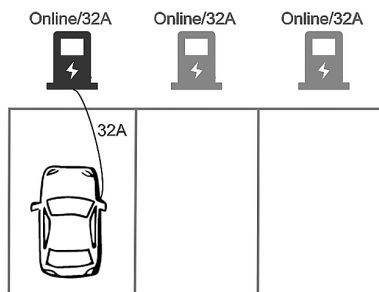

The second vehicle would receive 28A.

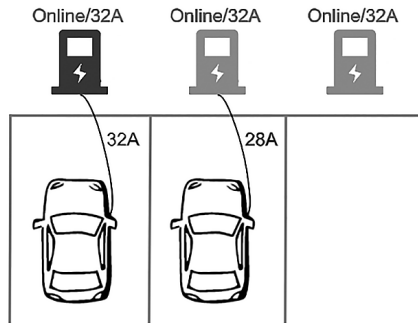

The third vehicle is NOT able to receive current.

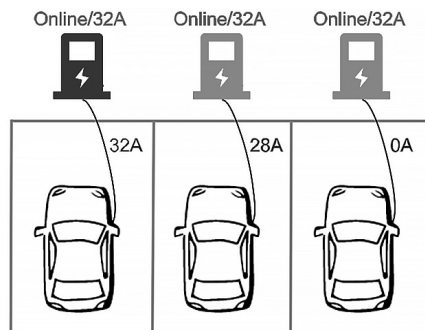

When the first vehicle leaves, the second vehicle receives 32 A, and the third vehicle would receives 28 A.

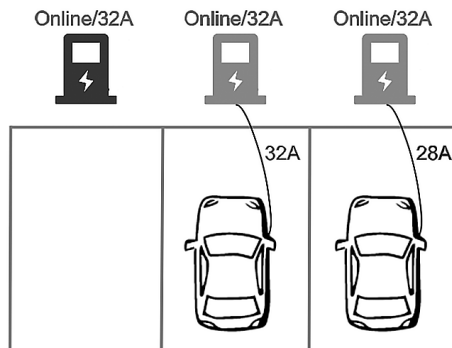

Example 2

In this example, there are five (32 A) charging stations in the LLM group and two of the charging stations are offline. Each charging station is set up according to the following settings:

Setting	Gateway	Client
Local Load Management	Enable	Enable
Charging Policy	First In First Serve	Not used
Group ID	LLM-Group-1	LLM-Group-1 (Same as Gateway)
Group Size	5	Not used
Max Amperage Grid Connection	100	Not used
Fallback Current	10	10 (Same as Gateway)

The first vehicle connected would receive 32 A. (Reserve 20A for offline charging stations)

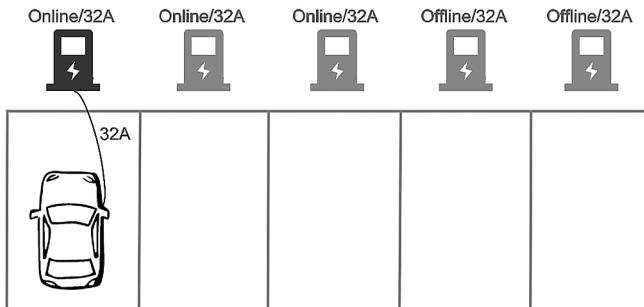

The second vehicle receives 32 A. (Reserve 20 A for offline charging stations)

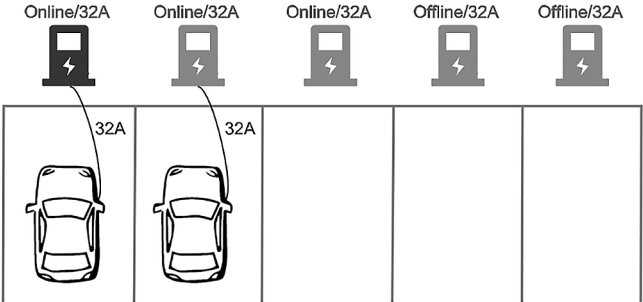

The third vehicle receives 16 A. (Reserve 20 A for offline charging stations)

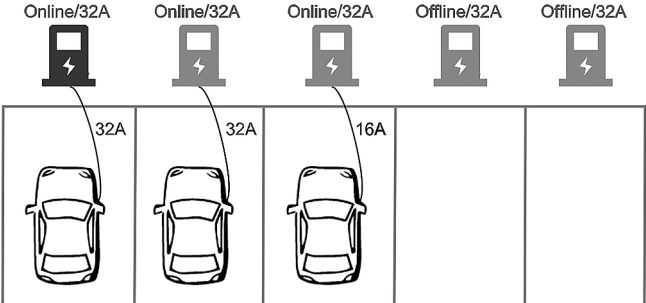

5.7 Security

5.7.1 Change password

To change the password, first choose the user whose password you want to change. There are two default users – **admin** and **maintain**. Only admin users can access the Security Page. Enter the old password and the new password then press **“Apply”** to change the user’s password.

To reset the password of all users, press **“Reset password of all users”**.

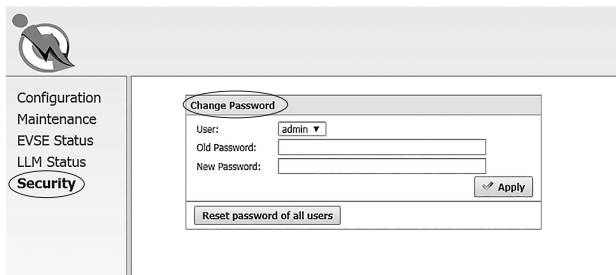

The screenshot displays a web interface for the Security page. On the left is a vertical navigation menu with the following items: Configuration, Maintenance, EVSE Status, LLM Status, and Security (which is highlighted with a red oval). At the top left of the main content area is a circular icon containing a crossed-out mouse cursor. The main content area features a 'Change Password' form, also highlighted with a red oval. This form includes a 'User:' dropdown menu currently set to 'admin', an 'Old Password:' text input field, and a 'New Password:' text input field. An 'Apply' button with a checkmark icon is located at the bottom right of the form. Below the form is a separate button labeled 'Reset password of all users'.

6. Activation Instructions

6.1 Activation Overview



Prior to activation, make sure to collect the necessary information for the site and charging station owner. Each charger has a visible Station ID QR code on it.

- Scan either of the codes to begin the activation process through our web portal.
 1. Enter the project code provided by Noodoe EV or your Charge Point Operator. If you do not have one, create a site. (see 6.3)
 2. Confirm or add station ID. (see 6.4)
 3. Upload photos of the charging station. (see 6.5)

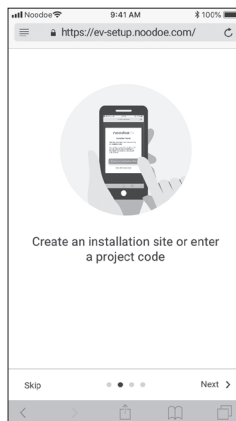
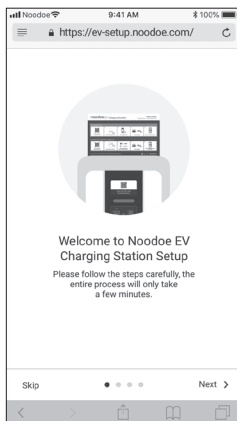

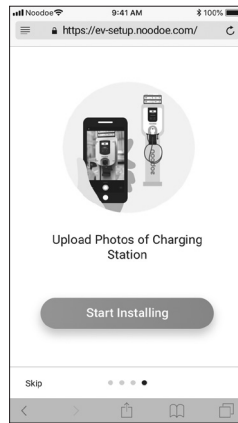
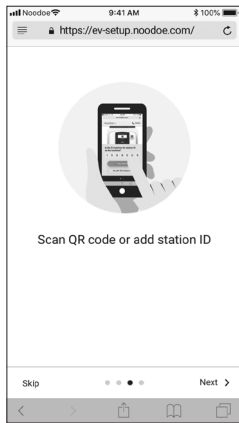

6.2 Prior to Activation

Before starting, collect the following information:

- Site Details
 1. Address
 2. Phone number
- Charging Station Owner's Credentials
 1. Full name
 2. Email address
 3. Phone number
- NOTE: The Charging Station Owner is responsible for setting prices, collecting revenue, and ensuring that the subscription service to Noodoe EV OS is paid for.

6.3 Creating a Site

If you have a project code provided either by Noodoe EV or your charge point operator, use that to begin the process. If there is no code, choose “Create an Installation Site” to begin activation.

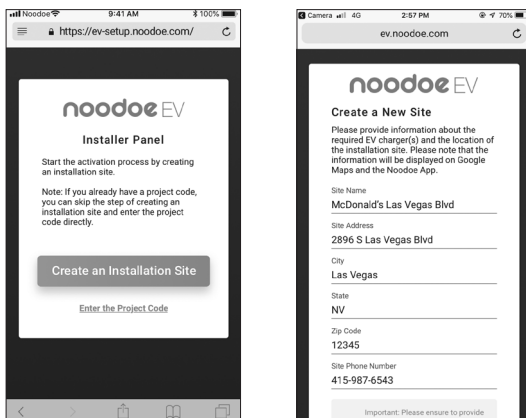

Site & Owners Information

- To finalize site creation, you will need a few pieces of information. Make sure you have all of this information before moving ahead with the activation procedure.
- Site Information:
 1. Site name
 2. Site address
 3. Site phone number
- Station Owner's Information
 1. Charging Station Owner's name
 2. Charging Station Owner's email address
 3. Charging Station Owner's phone number
- Installer information
- NOTE: This site information will be used on a charger location map, so it must be accurate. Additionally, the Charging Station Owner of the site will be responsible for managing the chargers, receiving payments made through them, and paying the subscription fees for Noodoe EV OS.

6.4 Adding Charging Stations

Make sure the stations are powered up and the site has been created in the setup program.

- Add each station one by one.
 1. Add stations by scanning their QR codes OR
 2. Add stations using their Station IDs

6.5 Taking Charging Station Photos

Photos are important for helping EV drivers find your charging stations. Take a photo of each station to be used in Google Maps and in the Noodoe App.

Photo Suggestions:

- Take closeups of each charger (with the QR code visible).
- Include pictures taken from a distance so drivers can see the parking environment.
- State parking instructions where necessary or useful.

7. Operations

7.1 Charging Status Indicators

Description	Definition
Not illuminated	Power Off
Green Steady	Ready
Green Flashing	Flashing green (Fast): Authorized, wait for the EV to connect Flashing green (Slow): Suspend (Occupying)
Blue Flashing	Flashing blue (Slow): Charging
Red Steady	Unrecoverable Fault
Red Flashing	Recoverable Fault
Purple Steady	Reserved (from OCPP Service)
Yellow Steady	Out of Service
Yellow Flashing	Booting / Firmware Upgrading

7.2 Authorization (for AC7LC Only)

Before the owner of an electric vehicle can start or stop charging, the Charge point has to authorize the operation.

7.2.1 Online Authorization

Description:

- Synchronized with the Central System when EVSE is Online.
- The EVSE SHALL only supply energy after authorization.

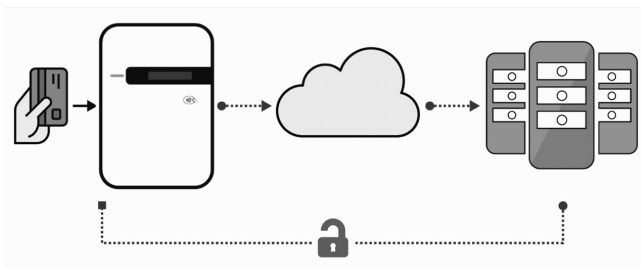

7.2.2 Local Authorization

Description:

- To improve the experience for users, the EVSE MAY support local authorization when EVSE is offline, and faster authorization response time when communication between the charge point and Central System is slow.

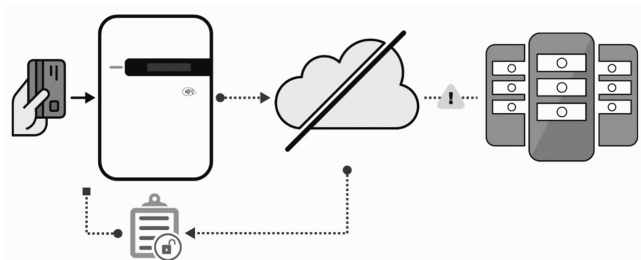

7.3 Charging an Electric Vehicle (EV)

Choices for how to start charging are as below:

7.3.1 Plug and Charge

1. Insert the charging plug into the EV
2. Begin the charging session

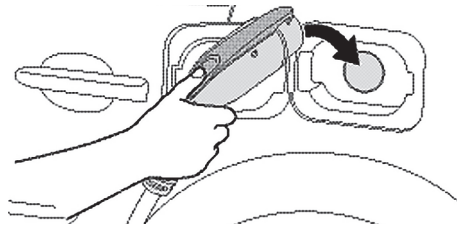

Place the EV charging plug

7.3.2 RFID card (for AC7LC Only)

1. Insert the charging plug into the EV
2. Swipe your card
3. Wait for authorization
4. Begin the charging session

7.4 Stop charging

1. Unplug any time (disconnect the charging plug from the EV to stop the charging session)
2. Session ended (please return the connector to the holster)

7.4.1 Interrupt charging

Please refer to the STOP CHARGING section for more information.

7.4.2 Auto restart

When a charging session is interrupted due to a temporary error condition, the charge point will automatically restart charging when the cause of the temporary error condition returns to normal. Status indicator lights will keep flashing RED until the error condition is resolved.

- Temporary error conditions include: Over Current, Over Voltage, Under Voltage, and Over Temperature.
- For Over Current conditions: The charging session will be stopped while OC occurs. 30 seconds after recovery from OC, the charge point will automatically restart charging three times.
- When charging session stopped due to CCID trip, the charge point will try to restart after 15 minutes for 3 times.

7.4.3 Power outage recovery

When power resumes after an outage, the charge point restarts automatically with a delay ranging from 120 to 720 seconds. The delay is designed to avoid impacting the utility grid when multiple charge points are in the same area attempting to resume charging simultaneously.

7.5 General care

The exterior of the charge point is designed to be waterproof and dust proof. To ensure proper maintenance of the charge point, follow these guidelines:

- Despite the water resistance of the enclosure, when cleaning it is preferred to not direct streams of water at the unit. Clean with a soft, damp cloth.
- Make sure the charging plug is put back in the holster after charging to avoid damage.
- Ensure the power cable is stored on the charge point after use to avoid damage.
- If the power cable or the charging plug is damaged, please contact Customer Support.

7.6 Customer Support

Please contact your reseller directly for technical support.

8. Federal Communication Commission Interference Statement

This device complies with Part 15 of the FCC Rules. Operation is subject to the following two conditions: (1) This device may not cause harmful interference, and (2) this device must accept any interference received, including interference that may cause undesired operation. This equipment has been tested and found to comply with the limits for a Class B digital device, pursuant to Part 15 of the FCC Rules. These limits are designed to provide reasonable protection against harmful interference in a residential installation. This equipment generates, uses and can radiate radio frequency energy and, if not installed and used in accordance with the instructions, may cause harmful interference to radio communications. However, there is no guarantee that interference will not occur in a particular installation. If this equipment does cause harmful interference to radio or television reception, which can be determined by turning the equipment off and on, the user is encouraged to try to correct the interference by one of the following measures:

- Reorient or relocate the receiving antenna.
- Increase the separation between the equipment and receiver.
- Connect the equipment into an outlet on a circuit different from that to which the receiver is connected.
- Consult the dealer or an experienced radio/TV technician for help.

FCC Caution: Any changes or modifications not expressly approved by the party responsible for compliance could void the user's authority to operate this equipment.

This transmitter must not be co-located or operating in conjunction with any other antenna or transmitter.

Radiation Exposure Statement:

This equipment complies with FCC radiation exposure limits set forth for an uncontrolled environment. This equipment should be installed and operated with a minimum distance 20 cm between the radiator and your body.

9. Industry Canada Statement

This device complies with ISED's licence-exempt RSSs. Operation is subject to the following two conditions: (1) This device may not cause harmful interference, and (2) this device must accept any interference received, including interference that may cause undesired operation.

Le présent appareil est conforme aux CNR d'ISED applicables aux appareils radio exempts de licence. L'exploitation est autorisée aux deux conditions suivantes : (1) le dispositif ne doit pas produire de brouillage préjudiciable, et (2) ce dispositif doit accepter tout brouillage reçu, y compris un brouillage susceptible de provoquer un fonctionnement indésirable.

Radiation Exposure Statement:

This equipment complies with ISED radiation exposure limits set forth for an uncontrolled environment. This equipment should be installed and operated with a distance greater than 20 cm between the radiator and your body.

Déclaration d'exposition aux radiations:

Cet équipement est conforme aux limites d'exposition aux rayonnements ISED établies pour un environnement non contrôlé. Cet équipement doit être installé et utilisé à plus de 20 cm entre le radiateur et votre corps.

This device is intended only for OEM integrators under the following conditions: (For module device use)

- (1) The antenna must be installed and operated with a distance greater than 20 cm between the antenna and users, and
- (2) The transmitter module may not be co-located with any other transmitter or antenna.

As long as both conditions above are met, further transmitter tests will not be required. However, the OEM integrator is still responsible for testing their end-product for any additional compliance requirements required with this module installed.

Cet appareil est conçu uniquement pour les intégrateurs OEM dans les conditions suivantes: (Pour utilisation de dispositif module)

- (1) L'antenne doit être installée et exploitée avec plus de 20 cm entre l'antenne et les utilisateurs, et
- (2) Le module émetteur peut ne pas être coimplanté avec un autre émetteur ou antenne.

Tant que les 2 conditions ci-dessus sont remplies, des essais supplémentaires sur l'émetteur ne seront pas nécessaires. Toutefois, l'intégrateur OEM est toujours responsable des essais sur son produit final pour toutes exigences de conformité supplémentaires requis pour ce module installé.

IMPORTANT NOTE:

In the event that these conditions cannot be met (for example certain laptop configurations or co-location with another transmitter), then the Canada authorization is no longer considered valid and the IC ID cannot be used on the final product. In these circumstances, the OEM integrator will be responsible for re-evaluating the end product (including the transmitter) and obtaining a separate Canada authorization.

NOTE IMPORTANTE:

Dans le cas où ces conditions ne peuvent être satisfaites (par exemple pour certaines configurations d'ordinateur portable ou de certaines co-localisation avec un autre émetteur), l'autorisation du Canada n'est plus considéré comme valide et l'ID IC ne peut pas être utilisé sur le produit final. Dans ces circonstances, l'intégrateur OEM sera chargé de réévaluer le produit final (y compris l'émetteur) et l'obtention d'une autorisation distincte au Canada.

10. Maintenance

10.1 Daily Maintenance

Please keep the charger in a clean area with low humidity. Do not install it in an environment near the sea, with high oil, high humidity or high quantities of dust.

- Avoid moisture or water in the charger. If there is water or moisture ingress into the charger, it is necessary to immediately power off to avoid immediate danger and to notify professional support personnel to carry out maintenance before next use.
- If there is any damage or dirt on the vehicle connector, charging cable, or vehicle connector holder, please contact maintenance personnel immediately.
- Please use the charger properly. Do not hit or press hard on the case. If the case is damaged, please contact a professional technician.
- Avoid placing the charger near hot objects or in high temperature locations, and keep it away from dangerous substances such as flammable gases and corrosive materials.
- Do not place external objects or heavy objects on the charger to avoid danger.

10.2 Maintenance Supplies

This product is equipped with adequate spare maintenance parts for regular maintenance use under and over the warranty period. Warranty services and repairs must be performed by company certified maintenance technicians. For details, please contact the charger distributor or customer service of the company.



Please visit the official website to obtain the latest version of the user manual before installation.

Website: www.noodoe.com