

IQAir® Atem® X

Room Air Purifier



User Manual

 AllergyCosmos



IQAir Atem X is an air purifier for those who care about the air they breathe. We hope you will enjoy its powerful yet quiet operation, space-saving design and smart functionality as much as we enjoyed designing and manufacturing it for you.

Use the IQAir AirVisual app to control your purifier from your smartphone. Atem X features built-in sensors that drive the purifier's smart mode for automatic fan speed control, optimal air cleaning performance and energy efficiency. The purifier's advanced filter monitoring system maximizes filter life and performance, thus minimizing waste and filter replacement cost.

Contents

1. Important safety instructions	1
2. Product overview	3
3. Getting started	5
Scan the QR code to connect	6
Fitting the mobile base	6
4. The control panel	7
Power	8
Smart mode	8
Fan speed selection	9
Air quality indicator	10
Light dimming	10
Wi-Fi	11
Schedule	11
Filter status	12
Control panel lock	12
5. Filter replacement	13
6. Cleaning the impactors	16
7. Technical specifications	17
8. Additional information	18

1. Important safety instructions - Read and save these instructions

Danger

- Never immerse the appliance in water.
- Do not allow any kind of liquid to spill on, enter or come into contact with the appliance, including, but not limited to water, detergents or flammable solvents.
- Do not spray any flammable materials such as insecticides, fragrance or perfumes into or around the appliance.

Warning

- This appliance can be used by children aged 8 years and above and by persons with reduced physical, sensory or mental capabilities, or lack of experience and knowledge only when supervised or instructions concerning the safe use of the appliance have been given by a person responsible for their safety and these persons understand the hazards involved.
- Children shall be supervised to ensure that they do not play with the appliance.
- Cleaning and other user maintenance must not be performed by children except when aged 8 years and above and supervised.
- Prior to cleaning, servicing or other maintenance, the appliance must be disconnected from the supply mains.
- The appliance must be securely fixed when placed on a bench-top surface or table.
- Do not use the appliance if the plug, the power cord, or the appliance itself is damaged. If the power cord is damaged, you must have it replaced by IQAir, a service center authorized by IQAir, or similarly qualified persons in order to avoid a hazard.
- Do not place the appliance in an area where it can be affected by dripping condensation, e.g. directly below an air conditioner.
- Do not place the appliance in or below an open window.
- Check that the voltage and frequency indicated on the appliance corresponds to the local mains voltage and frequency before connecting. Only plug the appliance into a suitable and easily accessible mains socket.
- In addition, for USA: This appliance has a polarized plug (one blade is wider than the other). To reduce the risk of electric shock, this plug is intended to fit in a polarized outlet only one way. If the plug does not fit fully in the outlet, reverse the plug. If it still does not fit, contact a qualified electrician. Do not attempt to defeat this safety feature.
- Do not run the power cord under carpeting. Do not cover the power cord with throw rugs, runners or similar coverings.
- Do not route the power cord under furniture or appliances. Arrange the power cord away from traffic area and where it will not be tripped over.
- Do not operate this appliance with a damaged cord or plug. Discard appliance or return to an authorized service facility for examination and/or repair.
- In case of needing instructions contained in electronic format as printed copy download from www.iqair.com and print or request at local dealer.

- To reduce the risk of fire or electric shock, do not use this appliance with any solid-state speed control device.
- In addition, for Canada: This appliance is not suitable for use with solid-state speed controls.
- Do not place the power cord under strain.
- Do not unplug the appliance by pulling on the power cord. To unplug, grasp the plug, not the power cord.
- Never sit or stand on the appliance. Sitting or standing on the appliance may lead to potential injury and appliance damage.
- Do not place any objects on the appliance.
- Make sure that foreign objects do not fall into the appliance.
- Never introduce a foreign object or finger into airflow openings.
- Do not use the appliance with any opening blocked; keep free of dust, lint, hair, and anything that may impede airflow.
- Always lift the appliance by the intended strap. Do not lift the appliance by the stand or by grasping the grille.
- Do not move the appliance by pulling its power cord.
- The appliance, when mounted on the supplied caster base, is easy to move. When moving the appliance with its caster base, do it slowly and do not push it rapidly.
- Only use this appliance in conjunction with its intended IQAir accessories and consumables.
- Only use this appliance in an atmosphere appropriate for permanent human habitation. Not suitable for use in toxic or explosive environments, or for protection against hazardous airborne substances. This appliance is not a substitute for proper ventilation, regular vacuum cleaning, or use of an extractor hood or fan while cooking.

Caution

- Use only indoors and in dry environments.
- This appliance is intended for use in living and office environments.
- Do not use near furnaces, fireplaces, stoves or other high temperature heat sources.
- This appliance contains high precision technology. Do not drop, tamper with nor expose to impact.
- Floor standing installation of the appliance shall be on a stable, level, and horizontal surface.
- Disconnect the appliance from the mains socket before moving it.

For more information also refer to:
www.iqair.com

2. Product overview

Atem X has a minimalist, round design. Its air inlet and outlet are arranged on the circumference of the air purifier.

The front of the air purifier is free of functional elements. The control panel is unobtrusively located on the back rim of the air purifier.

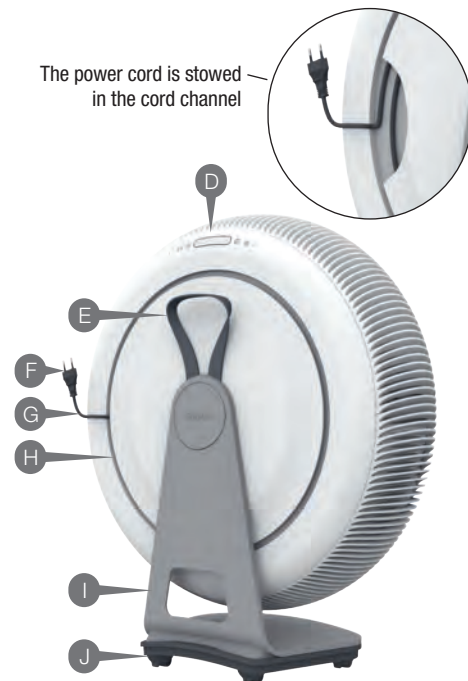
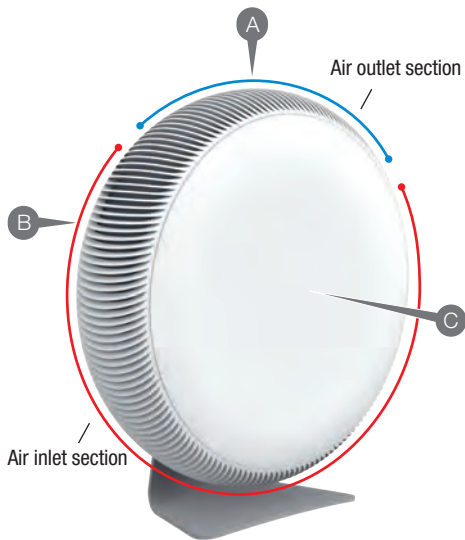







- A. Air outlet grille
- B. Air inlet grilles
- C. Front cover

- D. Control panel
- E. Strap
- F. Plug
- G. Power cord

- H. Cord channel
- I. Stand
- J. Mobile base



-  Power button
-  Smart mode button
-  Filter warning
-  Fan speed slider & air quality indicator
-  Light dimming button
-  Wi-Fi button
-  Ethernet indicator

Room air is drawn into the air purifier through three air inlet grilles and purified air is delivered through the air purifier's air outlet grille.

The three air inlet grilles can be removed for cleaning and to change the filters. The air outlet grille, which is positioned adjacent to the control panel is fixed and cannot be removed.

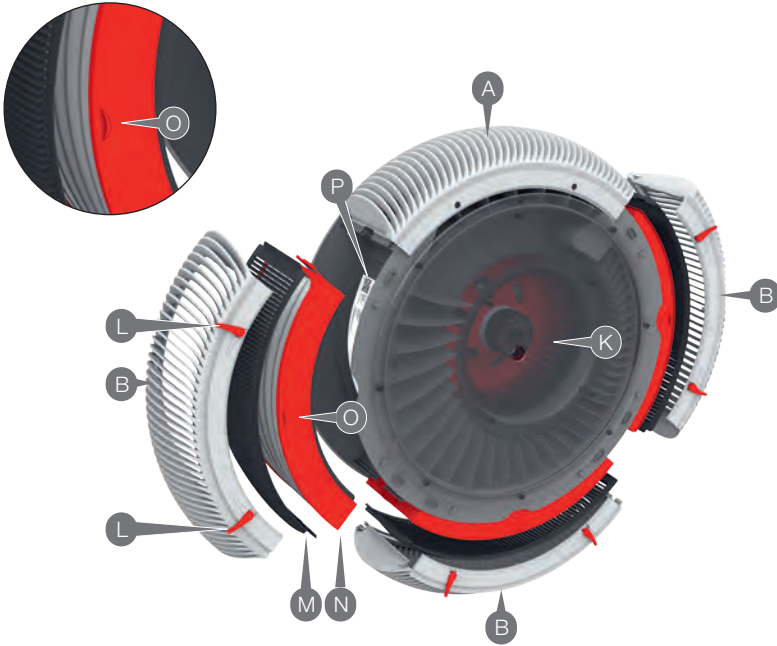

A. Air outlet grille
B. Air inlet grilles

K. Fan window
L. Locking levers
M. Impactor

N. Filter
O. Orientation tab
P. Type label

3. Getting started

Positioning

Take care when lifting the purifier. Use one hand to grasp the strap and the other to apply a balancing force onto the front cover.



Atem X can be placed directly against a wall or any other vertical surface, such as a cupboard or beside a sofa. It does not have to be positioned in the middle of the room.

When placing the purifier on the floor, the stand's non-slip feet ensure a steady stance on most surfaces. A mobile base is supplied, in case you regularly need to move the air purifier. Refer to *Fitting the mobile base* for more information (page 6).



Air flow direction

Rotate the purifier to change the direction of the air flow as desired. When the control panel is facing upward, i.e. at the 12 o'clock position, Atem X directs air upwards, to circulate and clean the air in the whole room.



Connect to power

Insert the plug into a suitable power socket. Arrange the power cord where it will not be tripped over, away from traffic areas. Excess cord can be stowed in the cord channel.

Using your air purifier

Atem X is in standby mode the first time you connect it to power. The purifier's control panel is located on the rear rim, behind the outlet grille. Press the power button to turn on the purifier. It will start up in smart mode, i.e., Atem X will immediately start to measure the air quality in your room and adjust the fan speed accordingly.

You can control your Atem X from your smart phone with the IQAir AirVisual app. The app also provides useful information about your indoor and outdoor air quality. Outdoor air quality information comes either from the nearest public outdoor monitoring station or your very own outdoor air monitor, such as the AirVisual Outdoor.



The smartphone icon in this guide indicates features that are available only in the app.

Scan the QR code to connect

Your purifier's QR code is printed on its ID Card, the Certificate of Performance and on the type plate, which is located in the inlet area, below the filter.



Scan the QR code to download the app and start the connection process. The app will guide you through the steps to connect with your Atem X.

Fitting the mobile base

You can mount your Atem X onto the supplied mobile base. This will allow you to easily move the purifier on smooth, hard surfaces. The mobile base is not suited for use on rough or carpet surfaces.

CAUTION: Do not use the mobile base where there is the risk for the air purifier to fall or be pushed over the edge of a surface, e.g., stairs, table top, sideboard, etc.

Tilt the purifier backwards and carefully lay it flat on the rear of the stand.

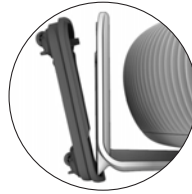

Position the mobile base so that the stand's heel fits into groove underneath the IQAir logo.

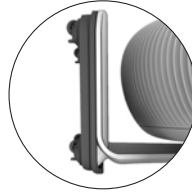

Pivot the mobile base to snap onto the purifier's stand.



Grasp the purifier by its strap and lift it back to the upright position.

Tip

Before you start be sure to have ready:

- a 2.4 GHz Wi-Fi network
- your Wi-Fi network name (SSID)
- and Wi-Fi password

Tip

Use a towel or similar protective sheet to prevent any damage to your floor or the purifier's stand.

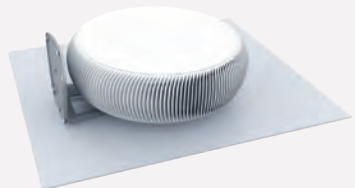

4. The control panel



The purifier's control panel is located on the rear rim, behind the outlet grille.



Power button

Touch to turn ON, touch again for standby.



Smart mode button

Touch to toggle between smart mode for automatic fan speed control and the manual fan speed setting.



Fan speed slider & air quality indicator

Touch the slider to set the fan speed. After 5 seconds the display reverts back to show the current air quality index (AQI) color.



Light button

Touch to turn the control panel lighting on/off.



Wi-Fi button

Touch and hold for 2 seconds to deactivate the purifier's Wi-Fi, touch again to reactivate.

The button is also used to initiate Wi-Fi connection, refer to the in-app instructions after scanning the purifier's QR code.



Filter status

Off: Enough filter life remaining, no action required.

Yellow: Low remaining filter life, replace your filters soon.

Red: Replace your filters.

Flashing: No filter detected.







Ethernet

Status of the Ethernet connection (only for models with Ethernet port).



Power

Touch the power button to turn on your purifier, touch again to switch to standby. When in standby, the purifier can be turned on from the app. All other buttons on the control panel are disabled when the purifier is in standby.



Indicator color	Power status
White	 ON - Fan is running, sensors are active.
Blue	 Standby
Yellow	 Scheduled standby (refer to <i>Schedule</i> on page 11). Fan is off, sensors remain active. The purifier can be turned on from the app.
Red	 OFF - Touch and hold the power button for 5 seconds to turn the purifier off. Fan, Wi-Fi and sensors are off. The purifier cannot be controlled from the app.



Smart mode

The smart mode automatically adjusts the purifier's fan speed according to the air quality. It utilizes real-time measurements from the air quality sensors to increase the fan speed when pollution levels rise and reduces the speed as the air gets cleaner.

Touch the smart mode button to activate/deactivate smart mode. Smart mode is also deactivated by touching anywhere on the fan speed control.

Indicator color	Smart mode status
White	 Smart mode is active, the fan speed is controlled automatically.
Off	 Smart mode is deactivated, the fan speed is controlled manually.



You can customize the Smart mode's automatic fan speed control to suit your environment by selecting one of the three smart modes in the app.

- Quiet mode:** For noise-sensitive environments such as bedrooms. Quiet mode steadily controls fan speed and limits the maximum fan speed to level 5.
- Balanced mode:** For normal living and working environments. Balanced mode limits the maximum fan speed to level 7.
- Max mode:** For living and working environments that require the highest level of air purification during episodes of high air pollution. Max mode rapidly changes the fan speed and does not limit the maximum fan speed.



Fan speed selection

Atem X has eight fan speed levels. Tap the control slider to show the current fan speed. Touch again to set the fan speed. The selected speed corresponds to the number of illuminated indicator dots. The indicators revert to display air quality after about 5 seconds.

Indicator		Fan speed
1 dot	○ ● ● ● ● ● ● ●	Fan speed 1 (Minimum)
2 dots	○ ○ ● ● ● ● ● ●	Fan speed 2
3 dots	○ ○ ○ ● ● ● ● ●	Fan speed 3
4 dots	○ ○ ○ ○ ● ● ● ●	Fan speed 4
5 dots	○ ○ ○ ○ ○ ● ● ●	Fan speed 5
6 dots	○ ○ ○ ○ ○ ○ ● ●	Fan speed 6
7 dots	○ ○ ○ ○ ○ ○ ○ ●	Fan speed 7
8 dots	○ ○ ○ ○ ○ ○ ○ ○	Fan speed 8 (Maximum)



Touch anywhere on the control slider to set the fan speed. Touching next to the minus symbol sets fan speed 1.



Touching next to the plus symbol sets fan speed 8 for maximum air cleaning performance.



Air quality indicator

Air quality is displayed as a color on the control panel slider.

Indicator color		Air quality description according to US AQI	Air quality description according to Chinese AQI
Green		Good	Excellent
Yellow		Moderate	Good
Orange		Unhealthy for Sensitive Groups	Lightly polluted
Red		Unhealthy	Moderately polluted
Purple		Very Unhealthy	Heavily polluted
Purple, flashing		Hazardous	Severely polluted



- Choose between US AQI and Chinese AQI in the app's Settings menu.
- The app provides a detailed display of your real-time and historical air quality.



Light dimming

Touch the light button to turn the control panel lighting on or off. When the purifier is in standby, the standby light will remain on. Note: Pressing any button on the control panel is acknowledged by a brief fade in/out of all indicators. This brief fade in/out occurs, also when the control panel lighting is turned off.

Indicator color		Light status
White		ON - Indicators on the control panel remain on.
Off		OFF - Indicators on the control panel fade out.



Adjust the control panel lighting by selecting one of the three brightness levels in the app.

Low: Lighting is dimmed to a low brightness level, ideal for dark environments.

Medium: Medium brightness level for dimly lit environments.

High: Maximum control panel brightness for well-lit environments.



Wi-Fi

Atem X can be connected to a Wi-Fi network to enable remote control via the app. The Wi-Fi button allows you to turn Wi-Fi on and off. To turn off Wi-Fi touch and hold for 2 seconds. The button is also used to connect the purifier to a Wi-Fi network.

Indicator color		Wi-Fi status
White		Connected to the Internet via Wi-Fi. The air purifier can be controlled via the app.
Red		Searching for a Wi-Fi network. Control via the app is not possible.
Yellow		Connection in progress. It may take a few minutes to establish a connection.
Off		Wi-Fi is deactivated. Touch to reactivate.



Ethernet

Some Atem X models feature an Ethernet socket for wired network connection.

Indicator color		Ethernet status
White		The purifier is connected to the Internet via Ethernet and can be controlled via the app.
Yellow		Connection in progress. It may take a few minutes to establish a connection.
Off		No Ethernet.



Schedule



You can use the app to define a schedule for your purifier.

Create a schedule to automatically turn the purifier on at specific times. You can set the required fan speed or Smart mode for each scheduled time slot. The power button on the purifier's control panel will light up yellow to indicate a scheduled standby.

Indicator color		Schedule status, power button indicator
Yellow		The schedule function has switched the purifier to standby.







Filter status

Atem X features smart filters that contain identification and performance parameters and store the filter's usage history. Atem X calculates the filter's life as a function of its capacity, the measured real-time airborne pollutant levels and fan speed.

The warning symbol on the control panel will inform you when the filters need to be replaced. A yellow warning symbol means the filter set needs to be replaced soon and should be reordered. A red warning symbol tells you that the filter set is full and should be replaced.

When filters have been replaced, Atem X automatically recognizes the new set and resets the filter status.

Indicator color		Filter status
Yellow		Your filters need to be replaced soon.
Red		Filters need to be replaced.
Red, flashing		No filters detected.
Off		Sufficient filter life available, no action required.



Get detailed information about your remaining filter life in the app.



Control panel lock



The purifier's control panel can be locked / unlocked from the app.

When the control panel is locked, all buttons are deactivated. Touching any of the buttons will cause all indicators to flash briefly in blue, but result in no other action. A locked control panel will be unlocked if the Internet connection is lost, and automatically lock again as soon as the Internet connection is reestablished.

Indicator color		Panel lock status
Blue, flashing		Control panel lock is active.

5. Filter replacement

Step 1

Remove the front cover

Pull and detach the front cover from the purifier.



Detach the front cover

Step 2

Remove the three inlet grilles

Open the locking levers. Slide out the inlet grilles to reveal the filters. Carefully set aside the inlet grilles

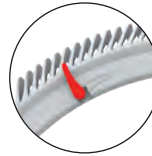

Open the locking levers

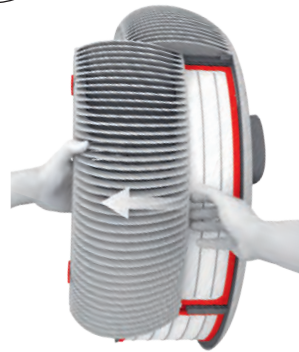

Slide out the inlet grilles

Tip

You can use the purifier's ID Card to pry off the front cover - pry it off far enough to easily grasp and pull the cover off by hand.

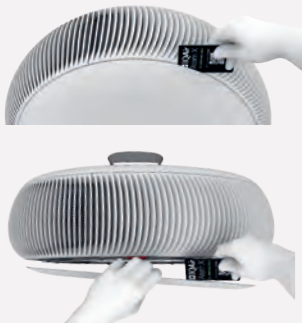

Tip

Rotating the purifier gives you easy access to each of the filters. Unplug the power cord before rotating.



Step 3**Remove the three used filters**

Press the latch towards the filter to unlock and remove the filter.

Do not try to clean and/or reuse the filters. Filters should be disposed with household waste.

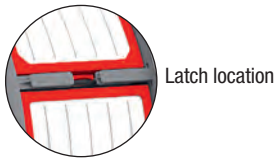

Press the latch towards the filter

Step 4**Insert the three replacement filters**

Make sure that the filter's orientation tab is facing towards the front of the purifier.

Insert the filter into the inlet opening. Slide the filter towards the left.

Press on the two ribbed corners until the filter snaps into place.

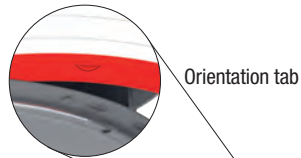

Slide the new filter towards the left

Tip

You should clean the impactors before replacing your filters. Refer to *Cleaning the impactors* (page 16).



Press down on the ribbed corners to snap the filter into place

Step 5**Replace the inlet grilles**

Check that the locking levers are still in the open position.

Ensure that the tabs on the inlet grille slide into the grooves on both sides of the inlet opening. Gently push the inlet grille back into position.

Rotate the locking levers into the closed position.



Open locking levers

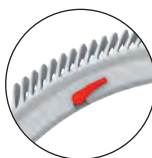

Closed locking levers



Slide in the grilles



Push the front cover into place

Step 6**Replace the front cover**

Align the spigot in the center of the front cover with the socket in the fan window. Push the front cover until it snaps into place.

6. Cleaning the impactors

Atem X impactors collect large particles, fibers, and lint.

An impactor is a momentum-based particle filter. Particles in the air stream are forced to make a sharp turn when passing through the impactor. The momentum of large particles prevents them from making the turn and they impact the collection surfaces. Small particles stay entrained in the air stream and get caught in the main filter.

It is recommended to clean the impactors every time filters are changed. You might need to check and clean the impactors more frequently if you have pets or if you use Atem X in a very dusty environment. Simply look into the inlet grilles. If you see hair and fluff clogging the impactors, they should be cleaned.

Remove and clean the impactors

Remove the front cover and air inlet grilles as shown in steps 1 & 2 of the filter replacement section (page 13).

Remove each impactor by pulling the center tab. Once removed, the impactors can be cleaned with a soft brush, or a vacuum cleaner fitted with a brush attachment. If required, the impactors can be cleaned further by rinsing under running water and then letting them dry.

Insert the dry, cleaned impactor back into the inlet grille. Ensure that the slots on the impactor match the tabs on the inner side of the grille. Hook the impactor slots underneath the grille's tabs – the impactor will arch outwards. Press downwards onto the center of the impactor.

Replace the inlet grilles and front cover as shown in steps 5 & 6 of the filter replacement section (page 15).



Pull the center tab to remove the impactor



Replace and press downwards onto the center of the impactor

7. Technical specifications

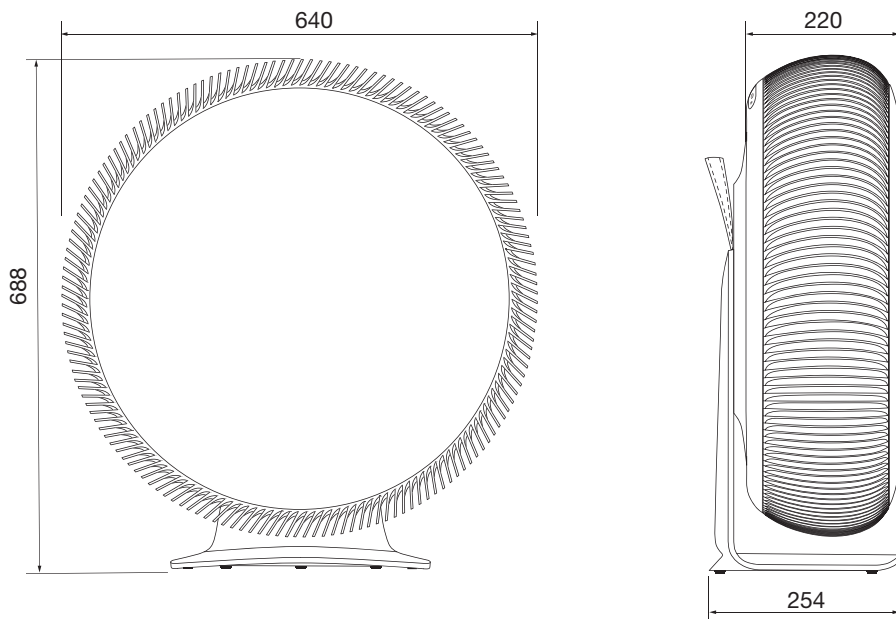

Input voltage (Refer to the type label on your device)	230 Volt version	220-240 V~ 50-60 Hz	
	110 Volt version	100-120 V~ 50-60 Hz	
Power rating	Rated power input	110 W	
	Networked standby (Wi-Fi on)	< 1.8 W	
	Standby (Wi-Fi off)	< 0.7 W	
	Off	< 0.5 W	
Weight & dimensions	Height	688 mm	27.1 in
	Depth	254 mm	10 in
	Weight ¹	13 kg	28.7 lb

¹ Weight may vary depending on the filter configuration

8. Additional information



Instructions pertaining to a risk of fire, electric shock, or injury to persons: unplug the power plug before cleaning or storing your Atem X.

Cleaning and storage

Use a lint-free cloth to clean external surfaces. Use a vacuum cleaner fitted with brush attachment to remove any loose dust from the inlet grilles.

When not in use, store your Atem X in a clean, dry place. Use the original packaging for optimal storage.

Environment

Help to preserve the environment. Filters may be disposed of with household waste. Do not burn used filters as fuel in a fireplace or for similar purpose.

Standards

For China:

The appliance has been tested and approved according to the following standards:

GB4706.45-2008, GB4706.1-2005, GB4343.1-2018, GB/T4343.2-2020, GB17625.1-2012, GB/T17625.2-2007.

Electromagnetic Compatibility (EMC)

For USA:

FCC Statement

Any changes or modifications not expressly approved by the party responsible for compliance could void the user's authority to operate the equipment.

Note: This equipment has been tested and found to comply with the limits for a Class B digital device, pursuant to part 15 of the FCC Rules. These limits are designed to provide reasonable protection against harmful interference in a residential installation. This equipment generates, uses and can radiate radio frequency energy and, if not installed and used in accordance with the instructions, may cause harmful interference to radio communications. However, there is no guarantee that interference will not occur in a particular installation. If this equipment does cause harmful interference to radio or television reception, which can be determined by turning the equipment

off and on, the user is encouraged to try to correct the interference by one or more of the following measures:

- reorient or relocate the receiving antenna;
- increase the separation between the equipment and receiver;
- connect the equipment to an outlet of a circuit different from that to which the receiver is connected;
- consult the dealer or an experienced radio/TV technician for help.

For Canada:

ISED RSS notice

This device complies with ISED license-exempt RSS standard(s). Operation is subject to the following two conditions: (1) this device may not cause interference and (2) this device must accept any interference, including interference that may cause undesired operation of the device.

ISED Radiation Exposure Statement

This equipment complies with ISED RF radiation exposure limits set forth for an uncontrolled environment. This transmitter must not be co-located or operating in conjunction with any other antenna or transmitter. Any changes or modifications not expressly approved by the party responsible for compliance could void the user's authority to operate the equipment. The type label showing the FCC ID 2AMBQ-ATEMX04/IC 22813-ATEMX04 is placed inside the device below the filter and visible during every filter change.

For South Korea:

EMC statement

This device is a household (class B) electromagnetic compatibility device. It is intended for home use and can be used in all areas.

RF statement

Since this radio device shows the possibility of radio wave interference it must not provide services related to human safety.

Powerful. Beautiful. Quiet.





 **IQAir**[®]
First in Air Quality