

**ELEMENT**  
GAS FIRES



# WORLD LEADING ELEGANCE

*Let yourself be seduced by Element4*





## DISCOVER OUR INNOVATIVE, WORLD-CLASS DESIGN FIREPLACES!

Are you looking for a gas fireplace to compliment your interior? Or even better: a gas fireplace that is an eye-catcher in your home or office building? Then choose a gas fireplace from Element4, a design fireplace made in the Netherlands, created by design enthusiasts and people with a passion for technology, just like you...

*A fireplace that fits you  
perfectly*

Are you someone who always wants the best? Who gets enthusiastic about products that distinguish themselves from the majority? Then a gas fireplace from Element4 is the right choice for you. Our design team consists of discerning people with passion for design, knowledge of the latest trends and love for special products. You can see that in the end result: a very stylish fireplace that demonstrates the difference between "a beautiful fireplace" and also "contemporary design piece."

### DUTCH COMMON SENSE WITH GLOBAL ALLURE

Element4 is a top Dutch brand. We work practically and pragmatically, but with a strong focus on design. This ensures that our fireplaces are loved around the world by designers, architects and trend-conscious consumers. As real 'Dutchies', technology is an important issue for us. Our fireplaces have the most advanced technical features: they are efficient, can be controlled remotely and have an adjustable flame picture. This makes us a real trend-setter on the international market.



# CONTENTS

- 06 BURNERS
- 08 LOW SETTING
- 09 INSTALLATION DEPTH
- 10 DIGITAL CONTROL
- 12 CLOSED SYSTEM
- 13 POWERFAN
- 14 BACK WALLS
- 16 NON-REFLECTIVE GLASS
- 18 FUEL BED
- 20 ACCESSORIES
- 22 PRODUCTS
- 96 TECHNICAL INFORMATION

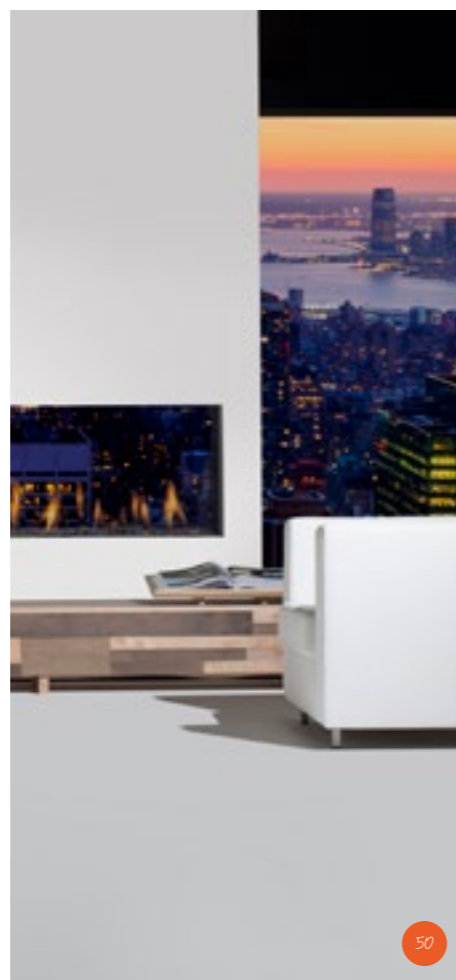

- FRONT-VIEW FIREPLACES** 24
  - CUPIDO 50 26
  - CUPIDO 70 28
  - MODORE 70 30
  - MODORE 75H 32
  - MODORE 100 34
  - MODORE 140 36
  - MODORE 185 38
  - MODORE 240 40
  - MODORE 240H 42
  - SKY 44
  - SUMMUM 70 F 46
  - SUMMUM 100 F 48
- SEE-THROUGH FIREPLACES** 50
  - BIOPTICA 52
  - SKY T 54
  - TENORE 100 56
  - TENORE 140 58
  - TENORE 240H 60
- CORNER FIREPLACES** 62
  - BIDORE 70 64
  - BIDORE 100 66
  - BIDORE 140 68
  - BIDORE 240H 70
  - SUMMUM 70 C 72
  - SUMMUM 100 C 74
- 3-SIDED FIREPLACES** 76
  - SUMMUM 70 3/S 78
  - SUMMUM 100 3/S 80
  - TRISORE 70 82
  - TRISORE 100 84
  - TRISORE 140 86
- ROOM DIVIDERS** 88
  - LUCIUS 100 90
  - LUCIUS 140 92
  - LUCIUS 240H 94

# BURNERS

Next to the fireplace of your choice it is always indicated what type of burner is suitable for this fireplace. These burners differ greatly from each other, but at the same time have one important similarity: they come standard with beautiful glowing logs. With this you can enjoy the most beautiful fire at a low setting!

*Enjoy the most beautiful fire at a low setting!*

## SINGLE BURNER

The single burner allows for a minimum installation depth of the fireplace and contributes to low consumption. Despite its modest appearance, it has a surprisingly big effect: full, lively flames with a realistic fireplace experience as a result.

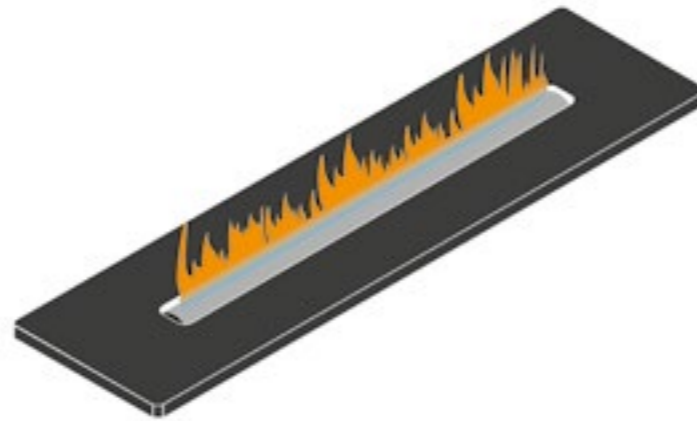

## MULTI BURNER

With no less than three burners, you benefit from even more beautiful and intense flames. You can switch off the burners left and right. This way you regulate the flame picture and the heat yourself.

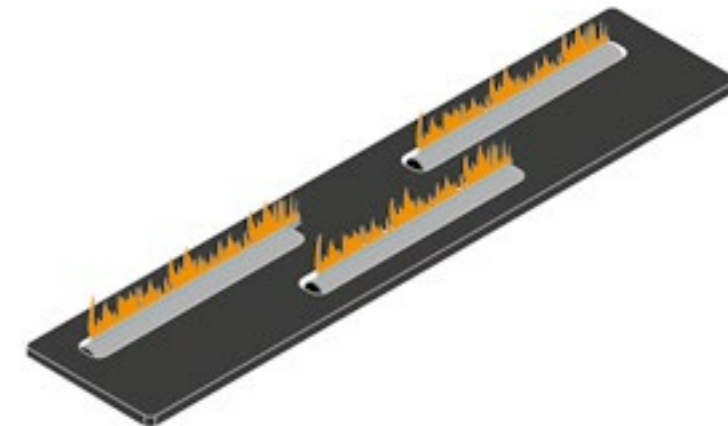

## DOUBLE BURNER

The double burner guarantees a beautiful fire experience because the fire is spread over the full depth of the fireplace. In addition, you can easily switch off one of the burners for optimum control of the heat and the flame picture.

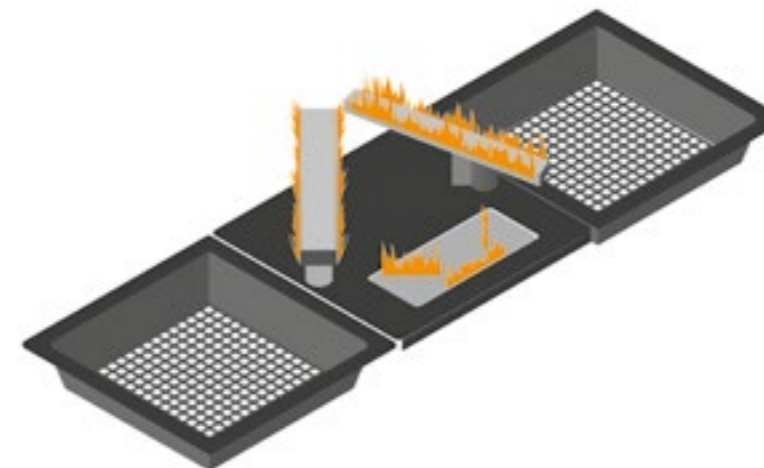
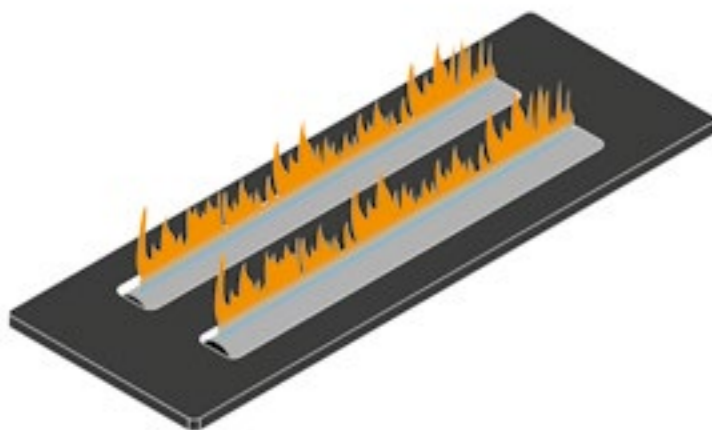

## REAL FLAME BURNER

With the Real Flame burner you are assured of an extremely realistic fire image. The special LED lighting effect on the fire surface provides a natural look. The flames, in combination with the realistic logs, create an utterly realist wood fire look.



## QUAD BURNER

The Quad Burner has five different burners. This way you can endlessly adjust the flames and the heat intensity. Thanks to the large number of burners, it is possible to create a lot of heat in a short time. At the same time you enjoy an impressive flame picture. Want to switch to low power? Then simply switch off a number of burners with the touch of a button.

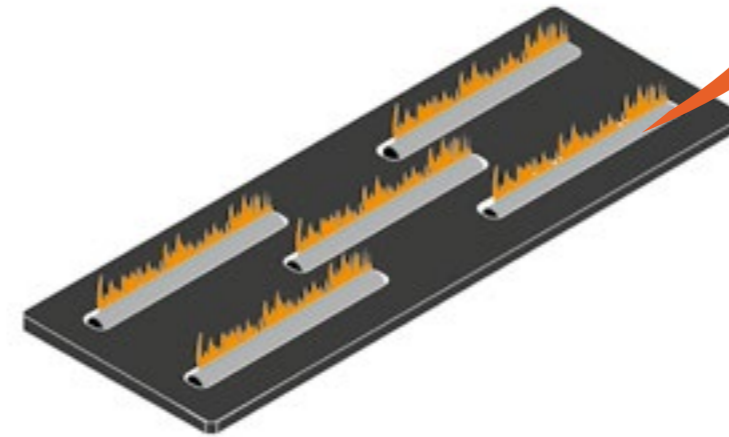

WE PROUDLY PRESENT TO YOU:

## THE MOST BEAUTIFUL FIRE AT A LOW SETTING

At Element4 we see it as a challenge to get the most out of our fireplaces. Our aim? Creating a lovely ambiance with a flame picture, regardless of the power on which the gas fireplace is running. Now you can enjoy a beautiful fire, even with the lowest possible gas consumption. It is no coincidence that we dare to say that a gas fireplace from Element4 "has the most beautiful fire at a low setting".



ELEMENT4 | *Installation depth*

## SAVE ROOM THANKS TO THE MINIMAL INSTALLATION DEPTH

Do you have limited amount of space available or do you want a gas fireplace that is as flat as possible to meet your design needs? Then an Element4 fireplace is the right choice for you. Our gas fireplaces are already feasible with an installation depth of only 25 cm. This is ideal if you have a narrow room or if you also want to install a mantel. Moreover, many designers and architects opt for our shallow fireplaces because of the spatial effect they have on the interior.

# DIGITAL CONTROL



PRO CONTROL

DOMOTICA

Want to easily control your gas fireplace from your smart phone or your tablet? This is possible with ProControl from Element4. ProControl is the perfect choice if you want to control your fireplace remotely, without the use of a home automation system. All you need is the supplied Element4 Wi-Fi box. The rest is already present in your fireplace and in the user-friendly ProControl app that you install on your smartphone or tablet. It could not be easier!

Do you want to control your Element4 gas fireplace with your existing home automation system? It's possible! Using home automation you can switch the gas fireplace on and off, turn it up or down and control the double burner. The installation is simple: you connect an Element4 home automation cable to the receiver of your gas fireplace and connect it to your home automation system. The rest speaks for itself. And if you cannot get it to work, your nearest dealer is always there to help you.



## DISCOVER THE ADVANTAGES OF OUR CLOSED SYSTEM

The gas fireplaces from Element4 work with a closed system. This means that the fireplace is not open to the room, but is completely enclosed. The fresh air and the flue gases run through the same, double-walled pipe that is connected to the outside air. What is the big advantage of a closed system? The flames are always behind the glass. This is safer and ensures heat retention in the balanced Flued system, with a higher convection heat and pleasantly warm room as a result. In addition, the supplied cold outside air is already preheated by the double-walled pipe. This ensures a greater return on your gas fireplace.

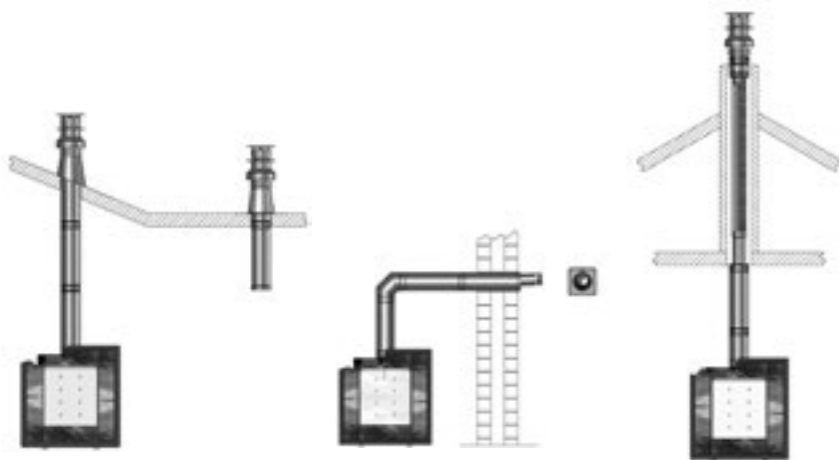

## WITH THE POWERFAN YOU CAN ENJOY A GAS FIREPLACE ANYWHERE

Want to install your gas fireplace in a place where there is no room for an exhaust pipe? You can do it with the Powerfan. This smart solution makes it possible to create a carry-over of no less than 36 meters within the flue. This allows you to install your gas fireplace in places where it previously was not possible. And the handy thing is: the device itself regulates the correct settings for the supply and removal of air.



## BACK WALLS

Element4 offers the possibility of choosing the back wall that best suits your interior. From a back wall in black steel, black glass or roof tile motif – the choice is completely up to you.

The options vary depending on the type of fireplace, thus check to see if the back wall you want is suitable for your fireplace. We offer the following styles and designs:



BLACK STEEL



BLACK GLASS



ROOF TILE MOTIF

*Choose your own style!*







## ANTI-REFLECTIVE GLASS

Want to enjoy an even more beautiful flame picture, so that it seems like you are looking straight into the fire? Have your fireplace specified with anti-reflective glass. This glass prevents annoying glare from incident light rays and is virtually invisible. Even when the fireplace is turned off, you cannot see the glass. This allows you to benefit from the best of both worlds: the convenience and comfort of a closed fireplace, with the atmosphere and flames of a real fireplace.



View the technical overview on page 96 to see which fireplaces can be specified with anti-reflective glass.



## FUEL BEDS

Your Element4 gas fireplace comes standard with gas logs. These realistic gas logs consist of smaller and larger branches made of ceramic, which are specially made for use in the gas fireplace. You can also choose other materials such as: white Carrara pebbles, white stones or grey stones.

The choices vary depending on the type of fireplace, do check carefully which type of fuel bed is available with your fireplace.



GAS LOGS



GAS LOGS



WHITE STONES

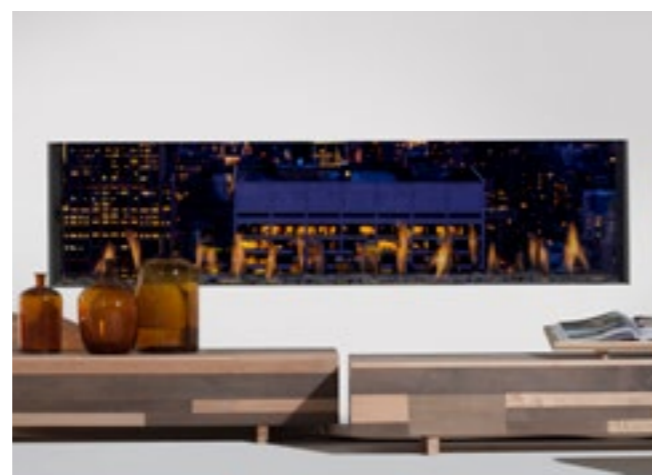

GREY STONES





## YOUR FIREPLACE IS COMPLETE WITH THE RIGHT ACCESSORIES

- 1 SERVICE HATCH**  
Do you have a gas fireplace without a frame? Then you need a service hatch for mounting the gas control block. The service hatch has an installation size of 250 mm x 175 mm (H x W) and is designed to be sleek and stylish. This way you are assured of an optimal match with the chimney breast.
- 2 WALL SWITCH**  
With a stylish switch on the wall, you can easily switch your gas fireplace on or off. You can also control the temperature with a touch of a button. It's a simple solution that is very easy to use.
- 3 REMOTE CONTROL**  
Our remote control features the E-Save control system. This allows you to switch the fireplace on and off remotely and to select different burner and temperature settings. Thus you save at least 40% on gas.
- 4 VENTILATION GRILLS**  
It is important that the chimney breast of your gas fireplace is well ventilated. You do this by placing ventilation grill on the sides of the chimney breast. This prevents high temperatures in the chimney breast and any cracks in the stucco. In addition, you benefit from optimal heat dissipation. The ventilation grill has an installation dimension of 231 mm x 43 mm (H x W) and has a high level of finish.

# PRODUCTS

*Looking for a contemporary and stylish gas fireplace that highlights your interior?*

Discover our versatile gas fireplace collection. From front-view and see-through fireplaces to room dividers and 3-sided fireplaces, with a gas fireplace from Element4 you are guaranteed to get optimal user-friendliness and fabulous design. Our gas fireplaces are easy to maintain and have a minimal installation depth starting at just 25 centimeters. This saves you valuable space. In addition, you benefit from the most beautiful fire at a low setting.





## Introduction

# FRONT-VIEW FIREPLACES

The front-view fireplace is a true classic among gas fireplaces. This type of fireplace has one glass plate and offers a beautiful view of the fire. You can easily install a front-view fireplace in a mantel or matching casing. Did you know that with an Element4 fireplace you only need 25 centimeters of installation depth? This way you make optimum use of the (limited) space. Be inspired by our collection and discover which type of fireplace is right for you.



# CUPIDO 50

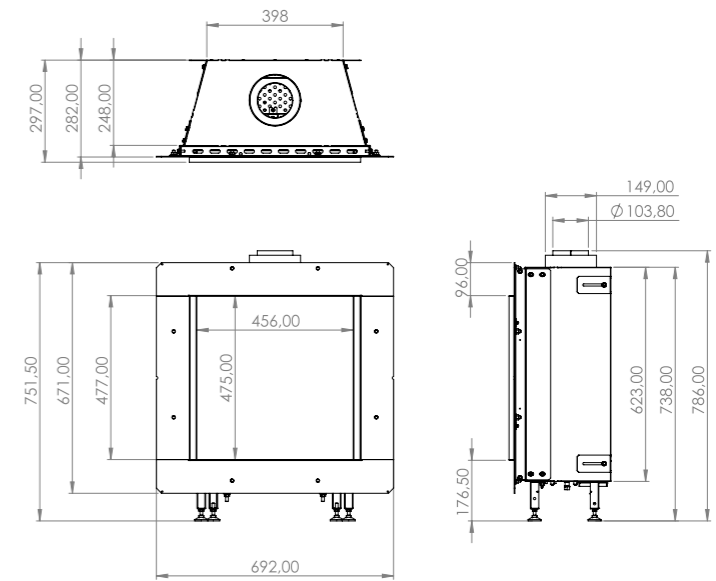

 Single burner

Natural gas G25 (min - max): 2,0 - 6,0 kW

Natural gas G20 (min - max): 2,1 - 6,1 kW

Propane G31 (min - max): 1,8 - 5,3 kW

Return: 83%

	Black steel:	Standard
	Black glass:	Optional
	Roof tile motif:	-

	E-Save:	Standard
	ProControl:	Optional
	Powerfan:	Optional
	AR-glass:	Optional

# CUPIDO 70

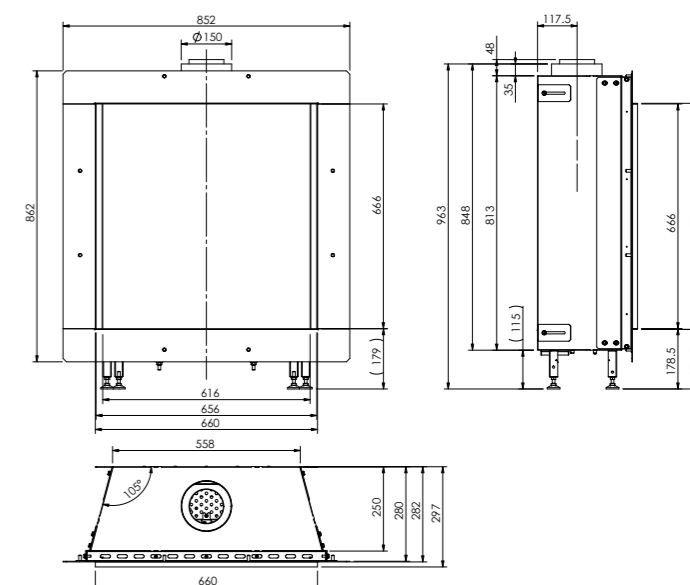

 Single burner

Natural gas G25 (min - max): 2,4 - 7,3 kW

Natural gas G20 (min - max): 2,9 - 7,9 kW

 Propane G31 (min - max): 2,0 - 5,9 kW

Return: 83%

 Black steel: Standard

Black glass: Optional

Roof tile motif: -

 E-Save: Standard

ProControl: Optional

Powerfan: Optional

AR-glass: Optional

 B

# MODORE 70

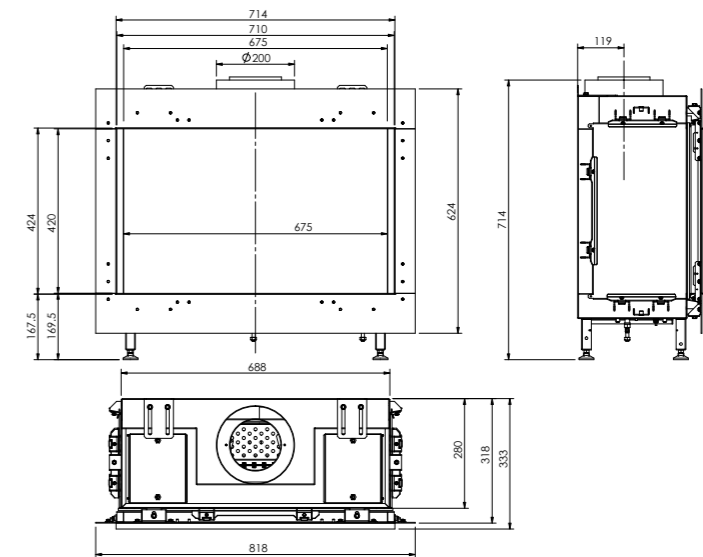

 Single burner

Natural gas G25 (min - max): 2,4 - 7,3 kW

Natural gas G20 (min - max): 2,6 - 7,6 kW

 Propane G31 (min - max): 2,3 - 6,8 kW

Return: 84%

 Black steel: Standard

 Black glass: Optional

Roof tile motif: -

 E-Save: Standard

 ProControl: Optional

 Powerfan: Optional

 AR-glass: Optional

 B



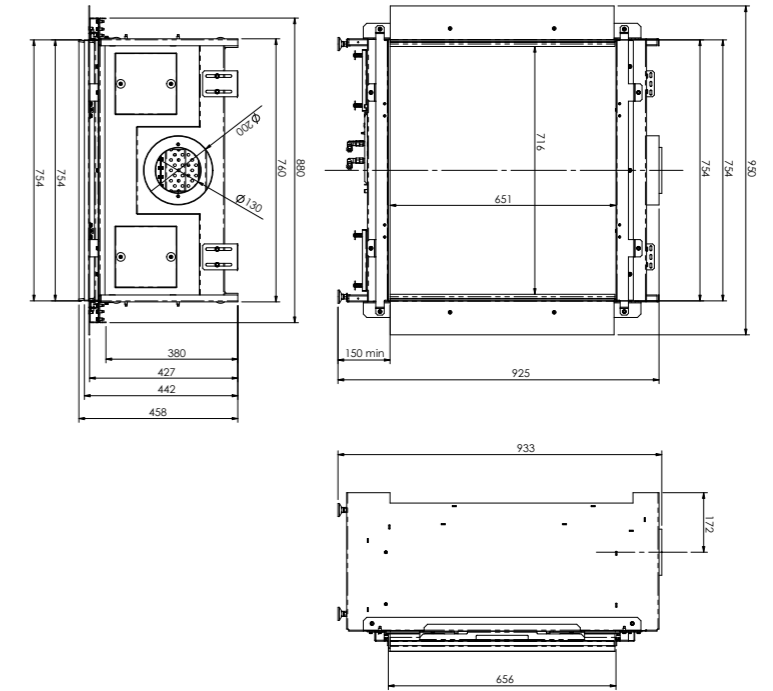

# MODORE 75H



 Double burner

Natural gas G25 (min - max): 3,3 - 10 kW

 Natural gas G20 (min - max): 3,6 - 10,8 kW  
Propane G31 (min - max): 3,6 - 10,7 kW  
Return: 89%

 Black steel: Standard  
Black glass: Optional  
Roof tile motif: Optional

 E-Save: Standard  
ProControl: Optional  
Powerfan: Optional  
AR-glass: Standard

 A

# MODORE 100

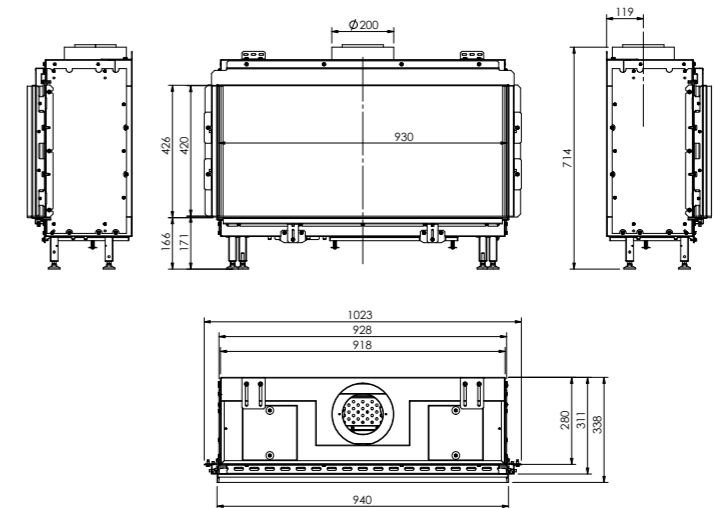

 Single burner

Natural gas G25 (min-max): 2,9 - 8,7 kW

Natural gas G20 (min-max): 3,2 - 9,7 kW

 Propane G31 (min-max): 2,2 - 6,5 kW

Return: 83%

 Black steel: Standard

Black glass: Optional

Roof tile motif: -

E-Save: Standard

ProControl: Optional

 Powerfan: Optional

AR-glass: Optional

 B

# MODORE 140

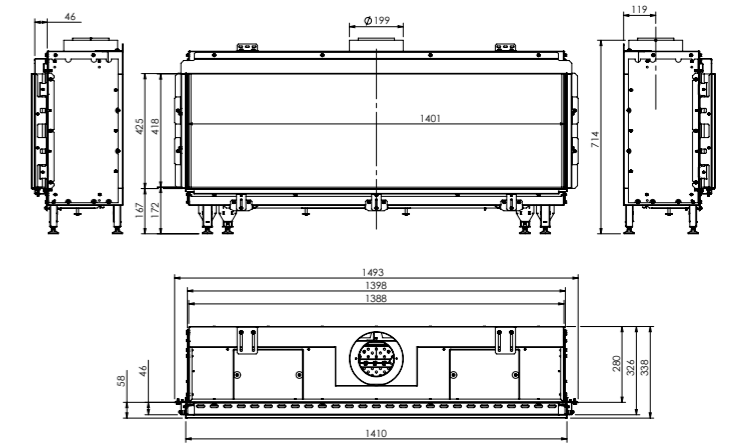

 Quad burner

Natural gas G25 (min-max): 2,2 - 12,9 kW

Natural gas G20 (min-max): 2,2 - 12,9 kW

 Propane G31 (min-max): 2,2 - 13,3 kW

Return: 90%

Black steel: Standard

 Black glass: Optional

Roof tile motif: -

E-Save: Standard

 ProControl: Optional

Powerfan: Optional

AR-glass: Optional

 A

# MODORE 185

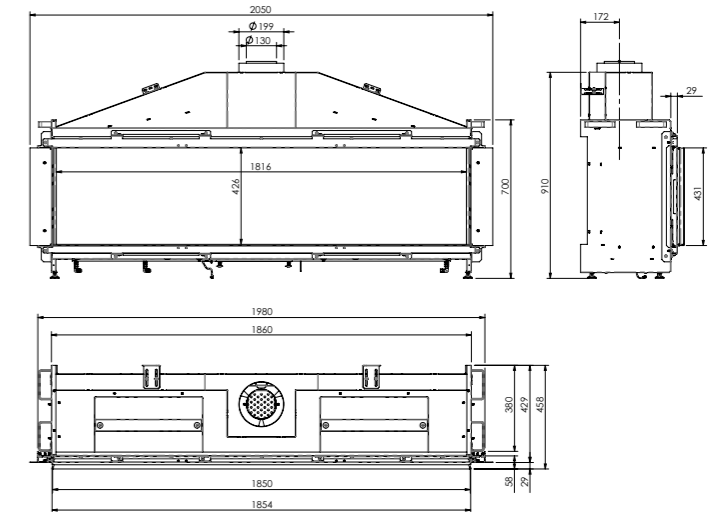



 Multi burner





Natural gas G25 (min-max): 3,6 - 10,8 kW

Natural gas G20 (min-max): 3,2 - 16,1 kW

Propane G31 (min-max): 2,7 - 13,7 kW

Return: 90%

 Black steel:	Standard
 Black glass:	Optional
 Roof tile motif:	-

 E-Save:	Standard
 ProControl:	Optional
 Powerfan:	Optional
 AR-glass:	Optional

 A

# MODORE 240

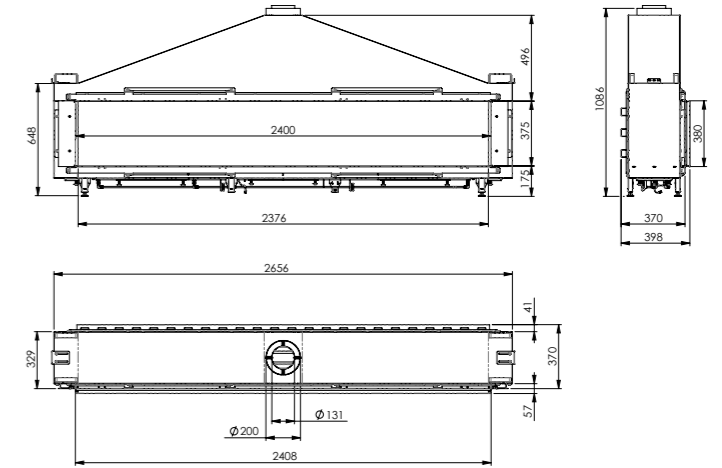

 Multi burner

Natural gas G25 (min-max): 3,5 - 17,6 kW

Natural gas G20 (min-max): 3,5 - 17,6 kW

 Propane G31 (min-max): 6,3 - 19,0 kW

Return: 89%

 Black steel: Standard

Black glass: Optional

Roof tile motif: -

E-Save: Standard

ProControl: Optional

 Powerfan: Optional

AR-glass: -

 A

# MODORE 240H

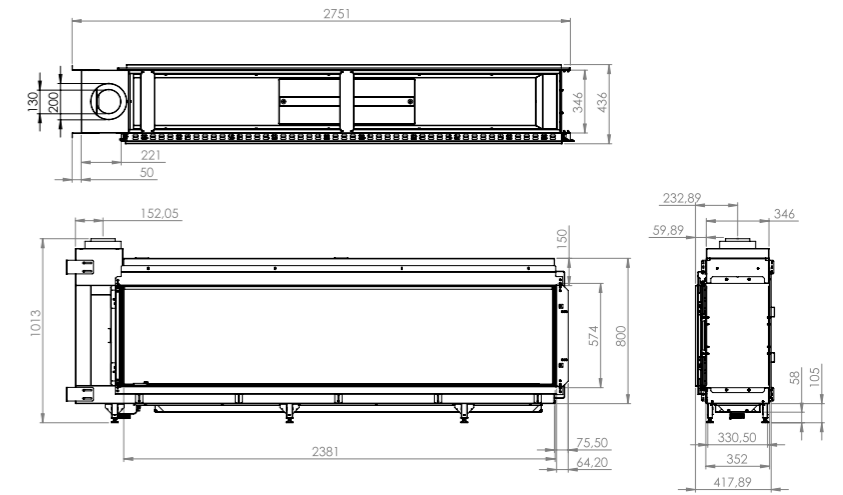

 Multi burner

Natural gas G25 (min-max): 3,5 - 17,6 kW  
 Natural gas G20 (min-max): 3,5 - 17,6 kW  
 Propane G31 (min-max): 6,3 - 19,0 kW  
 Return: 89%





 Black steel: Standard  
 Black glass: Optional  
 Roof tile motif: -

 E-Save: Standard  
 ProControl: Optional  
 Powerfan: Optional  
 AR-glass: -

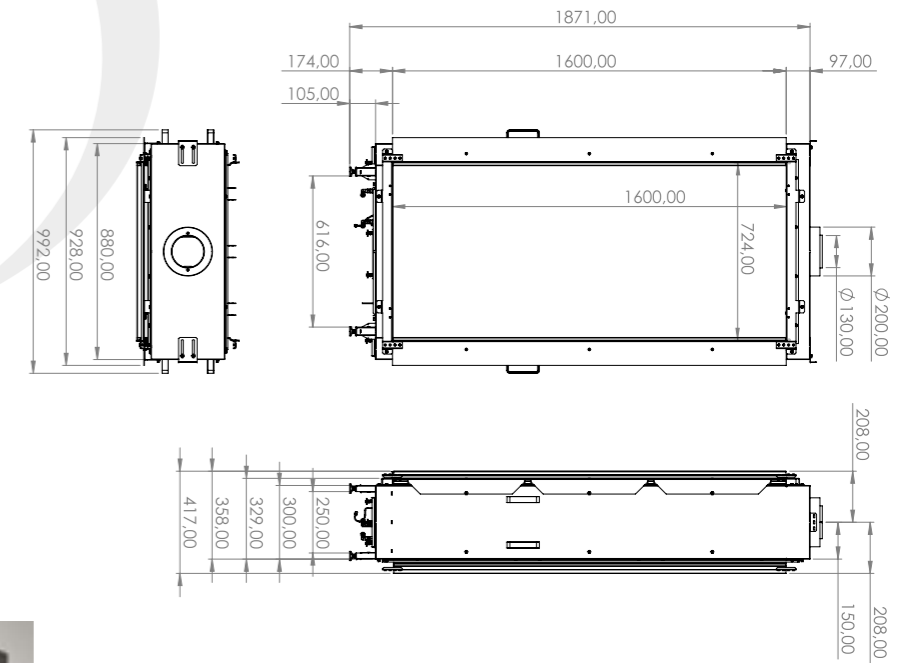
 A

# SKY



	Double burner:	
	Natural gas G25 (min-max):	2,7 - 10,8 kW
	Natural gas G20 (min-max):	2,7 - 10,8 kW
	Propane G31 (min-max):	2,6 - 10,3 kW
	Return:	86%
	Black steel:	Standard
	Black glass:	Optional
	Roof tile motif:	-
	E-Save:	Standard
	ProControl:	Optional
	Powerfan:	Optional
	AR-glass:	Optional



**B**

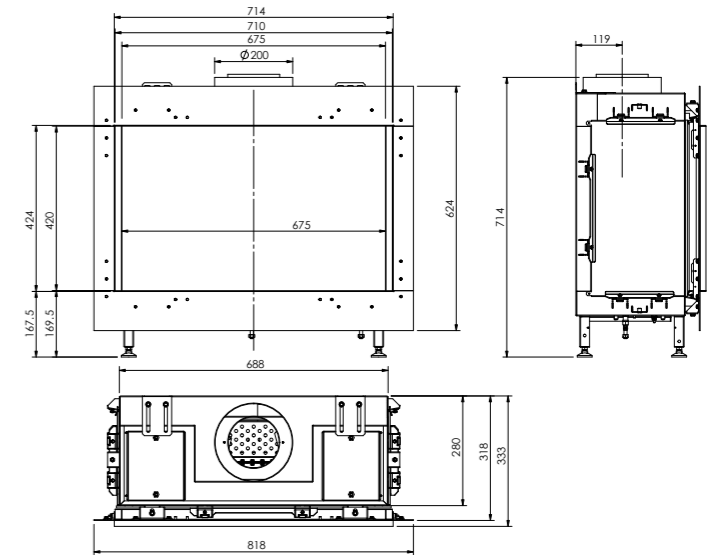



# SUMMUM 70 F



 Real flame burner

Natural gas G25 (min-max): 2,9 - 8,7 kW  
 Natural gas G20 (min-max): 2,6 - 7,6 kW  
 Propane G31 (min-max): 2,0 - 5,9 kW  
 Return: 88%

 Black steel: Standard  
 Black glass: Optional  
 Roof tile motif: -

 E-Save: Standard  
 ProControl: Optional  
 Powerfan: Optional  
 AR-glass: Optional

 A



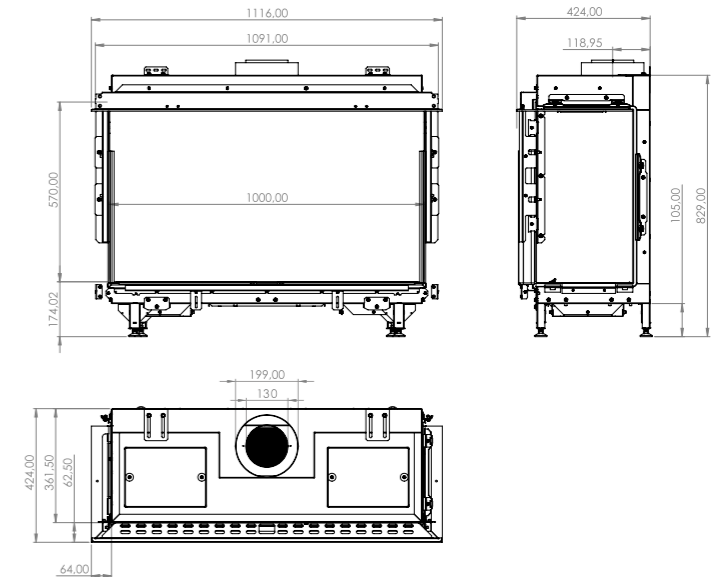

# SUMMUM 100 F



 Real flame burner

Natural gas G25 (min-max): 2,9 - 11,7 kW  
 Natural gas G20 (min-max): 2,7 - 10,9 kW  
 Propane G31 (min-max): 2,9 - 11,5 kW  
 Return: 89%

 Black steel: Standard  
 Black glass: Optional  
 Roof tile motif: -

 E-Save: Standard  
 ProControl: Optional  
 Powerfan: Optional  
 AR-glass: Optional

**A**



## Introduction

# SEE-THROUGH FIREPLACES

Would you prefer a see-through fireplace? Then you are choosing a beautiful eye-catcher. You place this type of gas fireplace in a wall, so that the fire is visible on both sides. This creates a special spatial effect. Moreover, a see-through fireplace creates an open connection between two rooms, allowing you to enjoy an atmospheric fire in two places at the same time. This is the perfect choice if you are looking for a gas fireplace with an optimal spatial experience.



# BIOPTICA

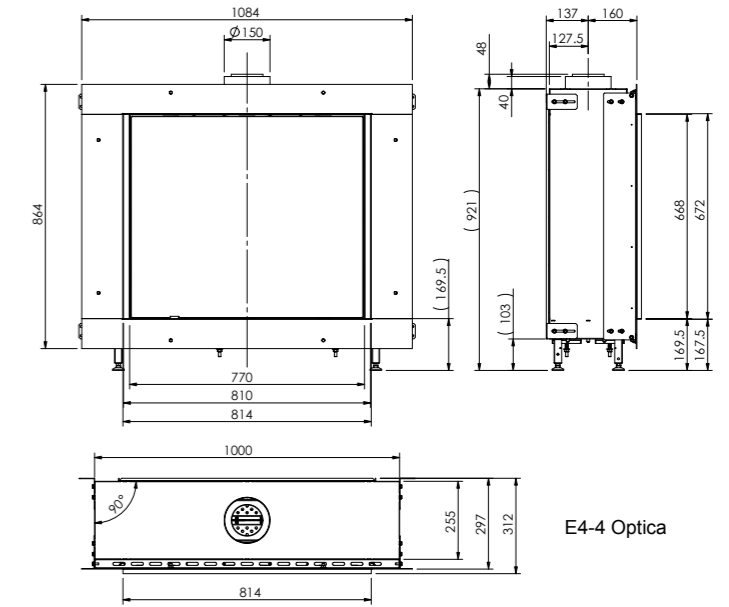

 Single burner

Natural gas G25 (min-max): 2,9 - 8,7 kW

Natural gas G20 (min-max): 3,2 - 9,7 kW

 Propane G31 (min-max): 2,6 - 7,8 kW

Return: 80%

Black steel: Standard

 Black glass: Optional

Roof tile motif: -

E-Save: Standard

 ProControl: Optional

Powerfan: Optional

AR-glass: Optional

**B**



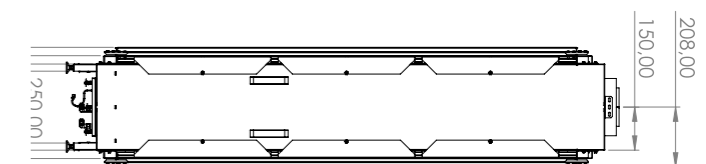
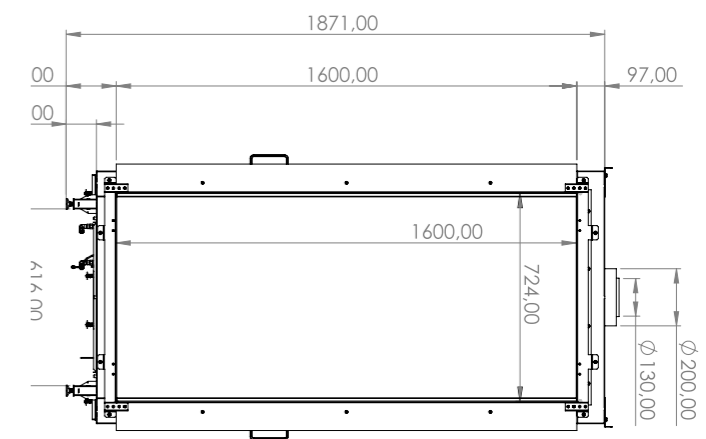

# SKY T



 Double burner

Natural gas G25 (min-max): 2,7 - 10,8 kW  
 Natural gas G20 (min-max): 2,7 - 10,8 kW  
 Propane G31 (min-max): 2,6 - 10,3 kW  
 Return: 86%

 Black steel: Standard  
 Black glass: Optional  
 Roof tile motif: -

 E-Save: Standard  
 ProControl: Optional  
 Powerfan: Optional  
 AR-glass: Optional

 B

# TENORE 100

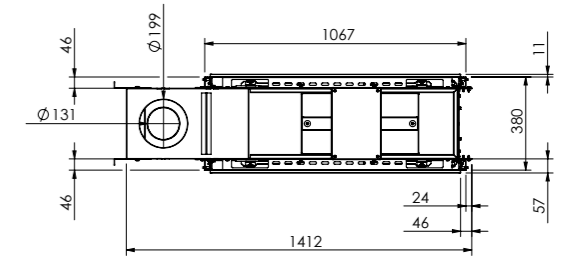
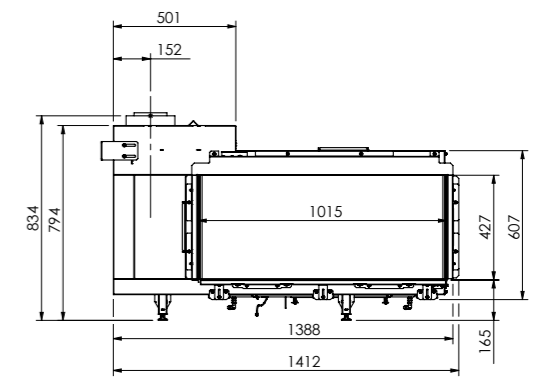
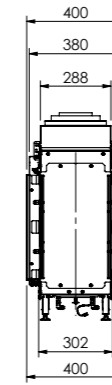

 Double burner

Natural gas G25 (min-max): 4,6 - 13,7 kW

Natural gas G20 (min-max): 4,3 - 13,0 kW

 Propane G31 (min-max): 4,3 - 12,8 kW

Return: 89%

 Black steel: Standard

 Black glass: Optional

 Roof tile motif: -

 E-Save: Standard

 ProControl: Optional

 Powerfan: Optional

 AR-glass: Optional

 A

# TENORE 140

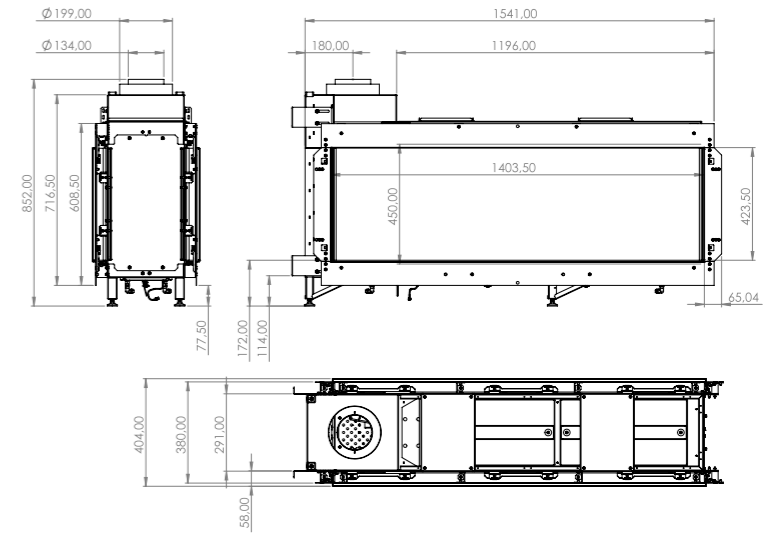

 Multi burner

Natural gas G25 (min-max): 2,2 - 12,9 kW

Natural gas G20 (min-max): 2,2 - 12,9 kW

 Propane G31 (min-max): 2,2 - 13,3 kW

Return: 90%

 Black steel: Standard

Black glass: Optional

Roof tile motif: -

E-Save: Standard

 ProControl: Optional

Powerfan: Optional

AR-glass: Optional

 A

# TENORE 240H

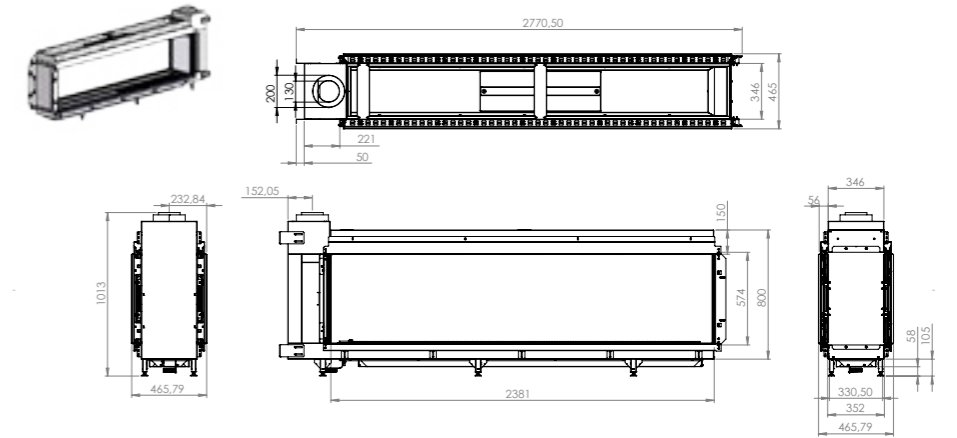

 Multi burner

Natural gas G25 (min-max): 3,5 - 17,6 kW

Natural gas G20 (min-max): 3,5 - 17,6 kW

 Propane G31 (min-max): 6,3 - 19,0 kW

Return: 89%

 Black steel: Standard

 Black glass: Optional

 Roof tile motif: -

 E-Save: Standard

 ProControl: Optional

 Powerfan: Optional

 AR-glass: -

 A



Introduction

## CORNER FIREPLACES

With a corner fireplace you create maximum ambiance in your room. This type of gas fireplace offers a wide view of the sparkling flames and provides even more atmospheric experience thanks to the extra pane. Element4 offers a choice of various sizes, installation possibilities and capabilities. This way you will always find a corner fireplace that matches your installation situation and interior.





# BIDORE 70

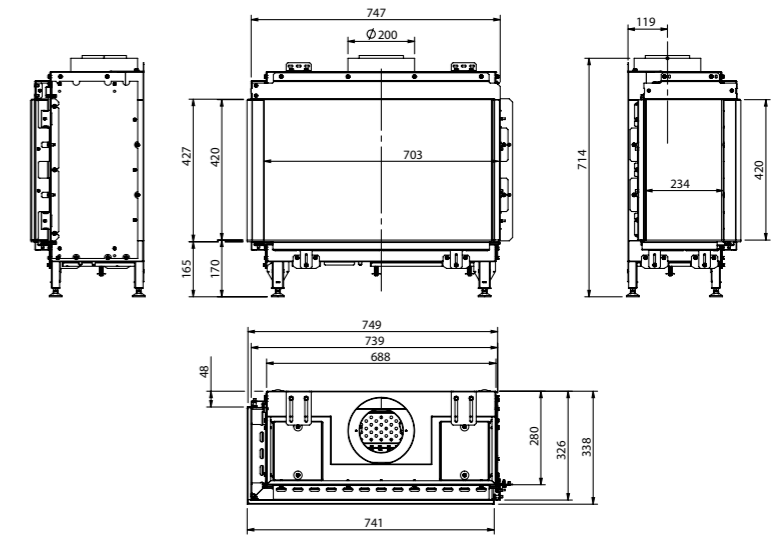

-  Single burner

---

- Natural gas G25 (min-max): 2,4 - 7,3 kW
- Natural gas G20 (min-max): 2,6 - 7,6 kW
-  Propane G31 (min-max): 2,3 - 6,8 kW
- Return: 84%

---

- Black steel: Standard
- Black glass: Optional
- Roof tile motif: -

---

- E-Save: Standard
- ProControl: Optional
-  Powerfan: Optional
- AR-glass: Optional

**B**

# BIDORE 100

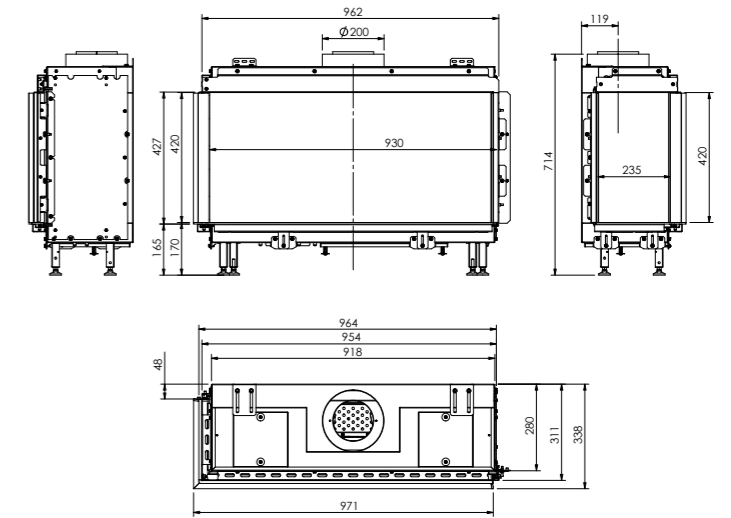

 Single burner

Natural gas G25 (min-max): 2,9 - 8,7 kW

Natural gas G20 (min-max): 3,2 - 9,7 kW

 Propane G31 (min-max): 2,2 - 6,5 kW

Return: 83%

 Black steel: Standard

Black glass: Optional

Roof tile motif: -

 E-Save: Standard

ProControl: Optional

Powerfan: Optional

AR-glass: Optional

**B**

# BIDORE 140

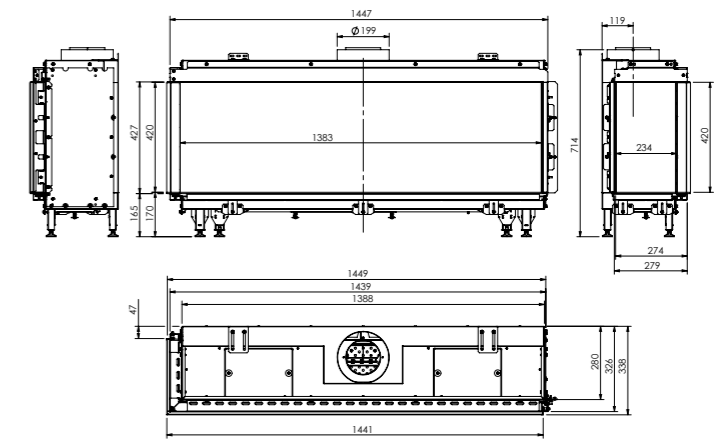

 Quad burner

Natural gas G25 (min-max): 2,2 - 12,9 kW

Natural gas G20 (min-max): 2,2 - 12,9 kW

 Propane G31 (min-max): 2,2 - 13,3 kW

Return: 90%

 Black steel: Standard

Black glass: Optional

Roof tile motif: -

 E-Save: Standard

ProControl: Optional

Powerfan: Optional

AR-glass: Optional

 A

# BIDORE 240H

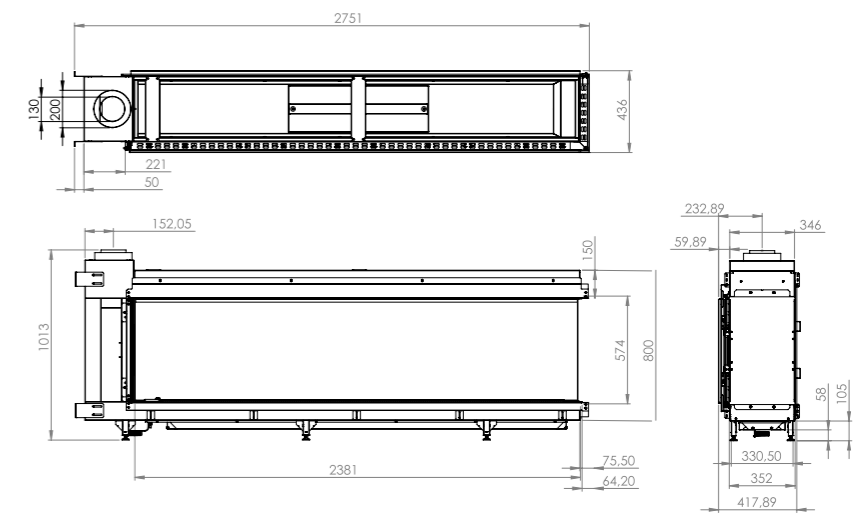

 Multi burner

Natural gas G25 (min-max): 3,5 - 17,6 kW

Natural gas G20 (min-max): 3,5 - 17,6 kW

Propane G31 (min-max): 6,3 - 19,0 kW

Return: 89%

 Black steel:	Standard
Black glass:	Optional
Roof tile motif:	-

 E-Save:	Standard
ProControl:	Optional
Powerfan:	Optional
AR-glass:	-

 A

# SUMMUM 70 C

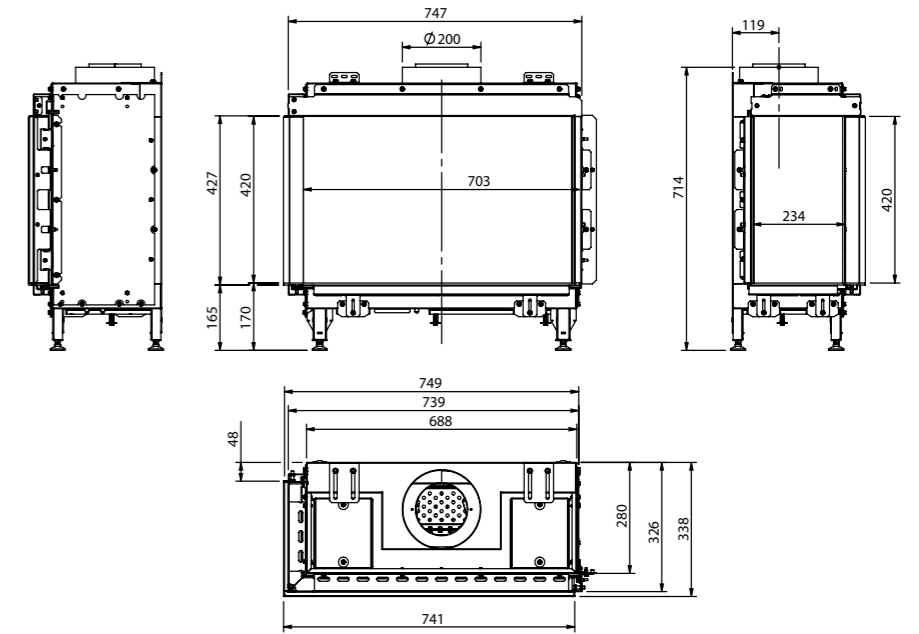

 Real flame burner

Natural gas G25 (min-max): 2,9 - 8,7 kW  
 Natural gas G20 (min-max): 2,6 - 7,6 kW  
 Propane G31 (min-max): 2,0 - 5,9 kW  
 Return: 88%

 Black steel: Standard  
 Black glass: Optional  
 Roof tile motif: -

 E-Save: Standard  
 ProControl: Optional  
 Powerfan: Optional  
 AR-glass: Optional

 A

# SUMMUM 100 C

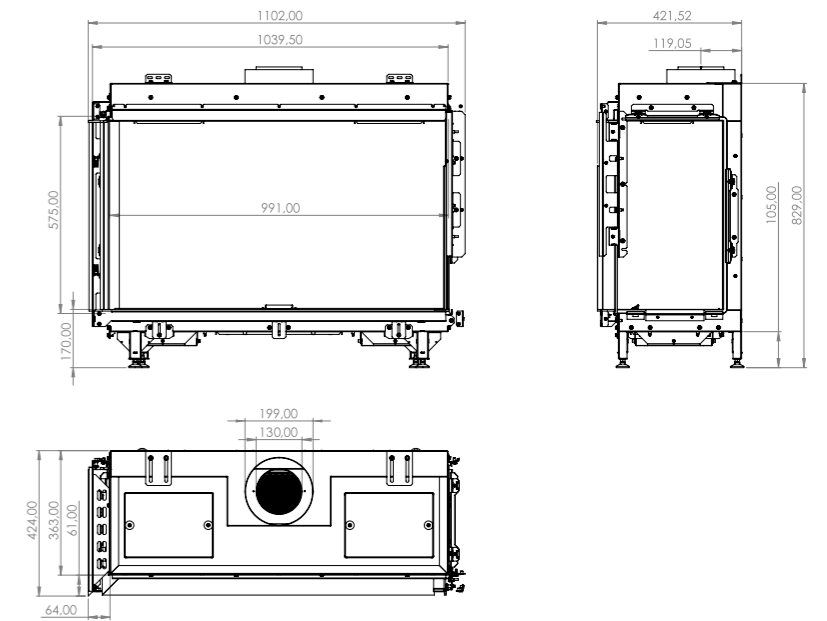

 Real flame burner

Natural gas G25 (min-max): 2,9 - 11,7 kW  
 Natural gas G20 (min-max): 2,7 - 10,9 kW  
 Propane G31 (min-max): 2,9 - 11,5 kW  
 Return: 89%

 Black steel: Standard  
 Black glass: Optional  
 Roof tile motif: -

 E-Save: Standard  
 ProControl: Optional  
 Powerfan: Optional  
 AR-glass: Optional

**A**



*Introduction*

## 3-SIDED FIREPLACES

The 3-sided gas fireplace gives you a view of the fire from multiple angles. Thanks to the use of multiple glass plates, you can use this fireplace in many creative ways within your interior. Element4 offers a suitable model for every taste and style, available in various sizes. Be inspired by the collection and find the 3-sided gas fireplace that best suits you.



# SUMMUM 70 3/S

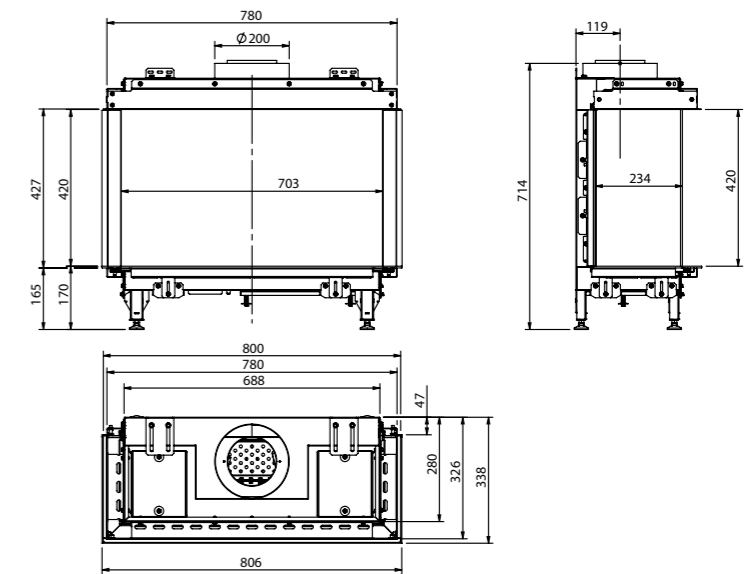

 Real flame burner

Natural gas G25 (min-max): 2,9 - 8,7 kW

Natural gas G20 (min-max): 2,6 - 7,6 kW

 Propane G31 (min-max): 2,0 - 5,9 kW

Return: 88%

Black steel: Standard

 Black glass: Optional

Roof tile motif: -

E-Save: Standard

ProControl: Optional

 Powerfan: Optional

AR-glass: Optional

 A



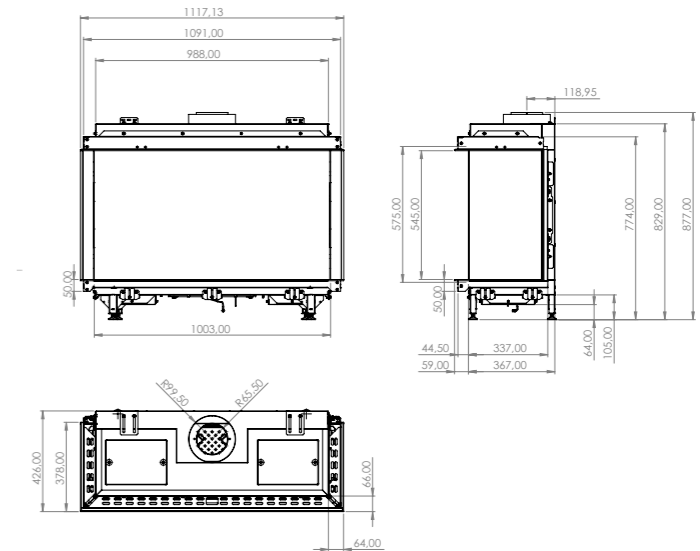

# SUMMUM 100 3/S



 Real flame burner

Natural gas G25 (min-max): 2,9 - 11,7 kW  
 Natural gas G20 (min-max): 2,7 - 10,9 kW  
 Propane G31 (min-max): 2,9 - 11,5 kW  
 Return: 89%

 Black steel: Standard  
 Black glass: Optional  
 Roof tile motif: -

 E-Save: Standard  
 ProControl: Optional  
 Powerfan: Optional  
 AR-glass: Optional

**A**

# TRISORE 70

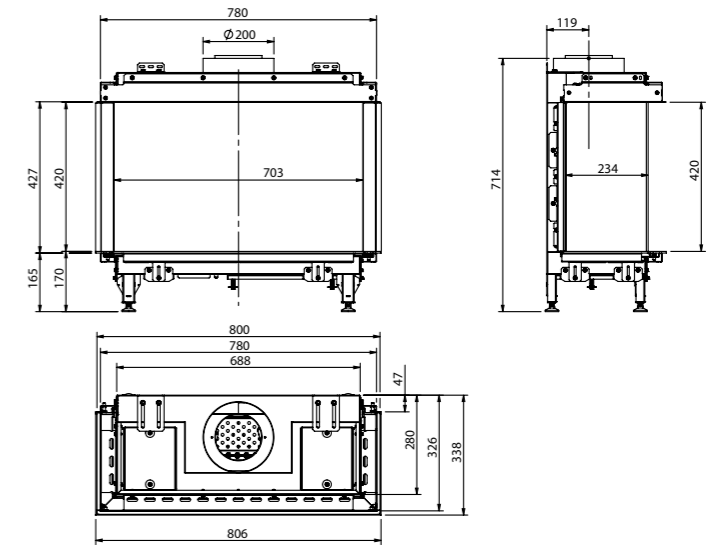

 Single burner

Natural gas G25 (min-max): 2,4 - 7,3 kW

Natural gas G20 (min-max): 2,6 - 7,6 kW

 Propane G31 (min-max): 2,3 - 6,8 kW

Return: 84%

Black steel: Standard

 Black glass: Optional

Roof tile motif: -

E-Save: Standard

ProControl: Optional

 Powerfan: Optional

AR-glass: Optional

**B**

# TRISORE 100

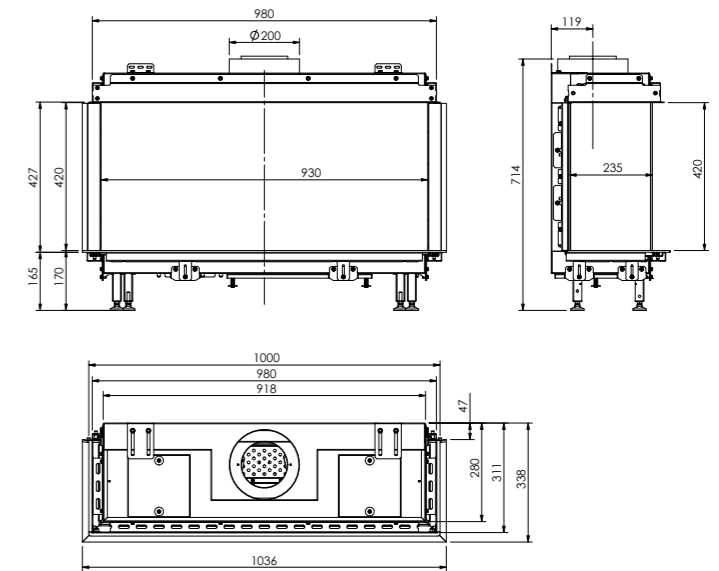

-  Single burner

---

- Natural gas G25 (min-max): 2,9 - 8,7 kW
- Natural gas G20 (min-max): 3,2 - 9,7 kW
-  Propane G31 (min-max): 2,2 - 6,5 kW
- Return: 83%

---

-  Black steel: Standard
- Black glass: Optional
- Roof tile motif: -

---

-  E-Save: Standard
- ProControl: Optional
- Powerfan: Optional
- AR-glass: Optional

**B**

# TRISORE 140

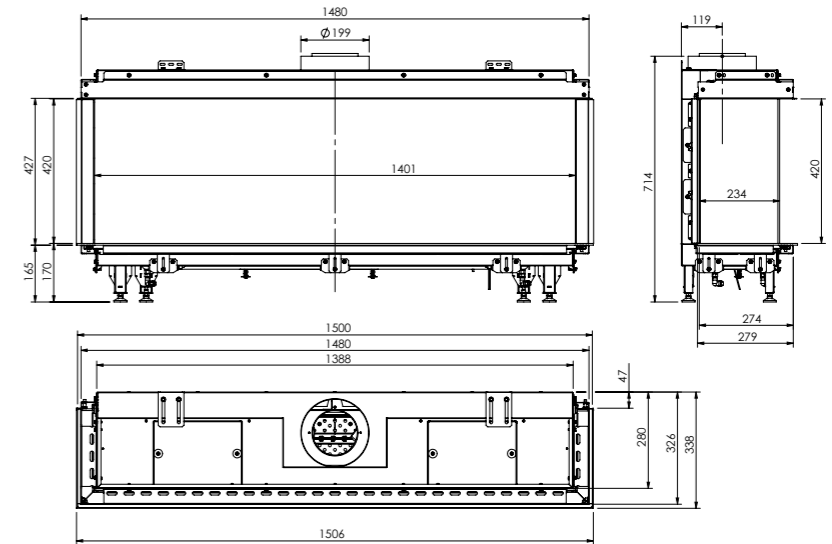

 Quad burner

Natural gas G25 (min-max): 2,2 - 12,9 kW

 Natural gas G20 (min-max): 2,2 - 12,9 kW

Propan G31 (min-max): 2,2 - 13,3 kW

Rendement: 90%

Black steel: Standard

 Black glass: Optional

Roof tile motif: -

E-Save: Standard

ProControl: Optional

 Powerfan: Optional

AR-glass: Optional

 A



*Introduction*

## ROOM DIVIDERS

Choose a gas fireplace as a room divider and create a stylish separation between two different rooms. Thanks to the tall glass pane, you can view the realistic fire from several positions. In addition, you can enjoy the warmth in both rooms. The room divider can be installed floating or in a wall. Discover our collection of room dividers and be inspired by the ambiance they create.



# LUCIUS 100

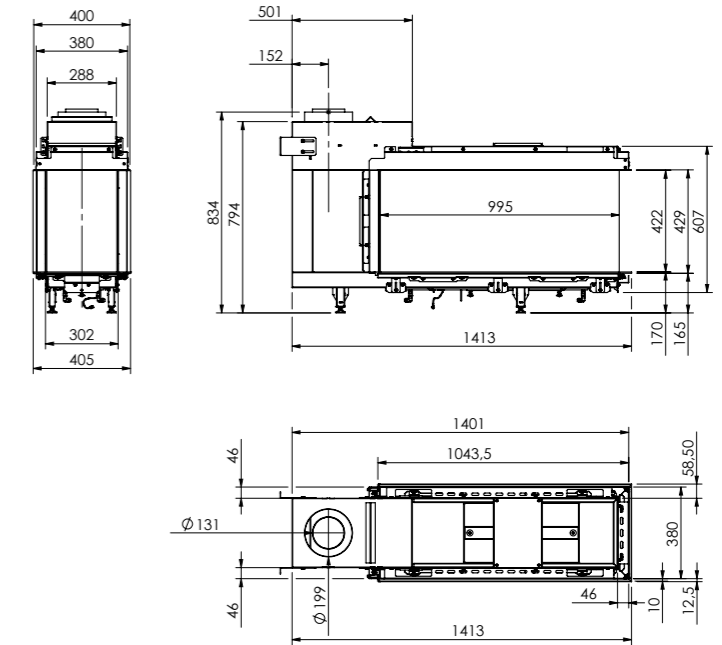

 Double burner

Natural gas G25 (min-max): 4,6 - 13,7 kW

Natural gas G20 (min-max): 4,3 - 13,0 kW



Propane G31 (min-max): 4,3 - 12,8 kW

Return: 89%



Black steel: Standard

Black glass: Optional

Roof tile motif: -



E-Save: Standard



ProControl: Optional





Powerfan: Optional

AR-glass: Optional

 A

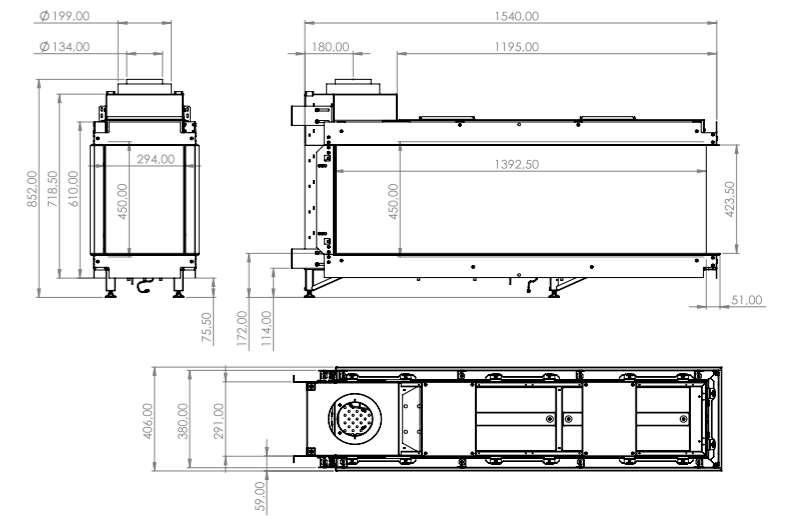
# LUCIUS 140





 Quad burner

Natural gas G25 (min-max): 2,2 - 12,9 kW

Natural gas G20 (min-max): 2,2 - 12,9 kW

 Propane G31 (min-max): 2,2 - 13,3 kW  
Return: 90%





 Black steel: Standard  
Black glass: Optional  
Roof tile motif: -

 E-Save: Standard  
ProControl: Optional  
Powerfan: Optional  
AR-glass: Optional

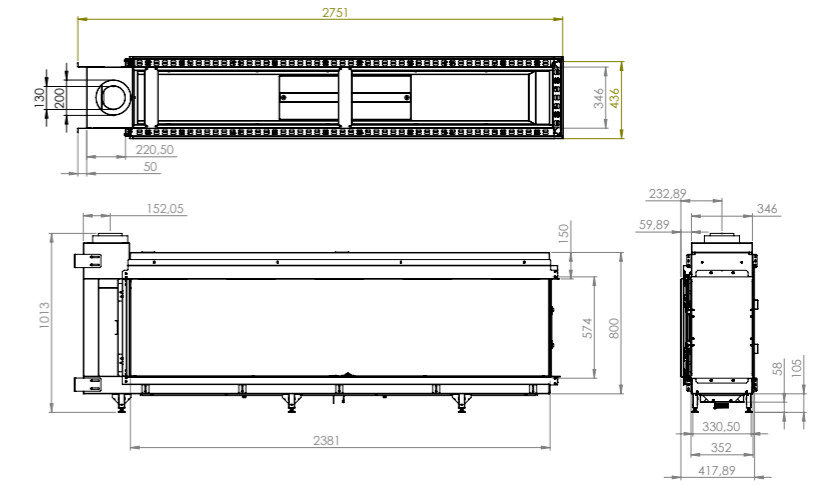
 A

# LUCIUS 240H



	Multi burner
<hr/>	
	Natural gas G25 (min-max): 3,5 - 17,6 kW
	Natural gas G20 (min-max): 3,5 - 17,6 kW
	Propane G31 (min-max): 6,3 - 19,0 kW
	Return: 89%
<hr/>	
	Black steel: Standard
	Black glass: Optional
	Roof tile motif: -
<hr/>	
	E-Save: Standard
	ProControl: Optional
	Powerfan: Optional
	AR-glass: -

**A**





	<i>CUPIDO 50</i>	<i>CUPIDO 70</i>	<i>MODORE 70</i>	<i>MODORE 75H</i>	<i>MODORE 100</i>	<i>MODORE 140</i>	<i>MODORE 185</i>	<i>MODORE 240</i>	<i>MODORE 240H</i>	<i>SKY</i>	<i>SUMMUM 70 F</i>
Burner	Single	Single	Single	Double	Single	Quad	Multi	Multi	Multi	Double	Real flame
Type of fireplace	Front	Front	Front	Front	Front	Front	Front	Front	Front	Front	Front
Natural gas	●	●	●	●	●	●	●	●	●	●	●
Propane	●	●	●	●	●	●	●	●	●	●	●
Netpower kW min-max Natural gas G25	2,0 - 6,0	2,4 - 7,3	2,4 - 7,3	3,3 - 10	2,9 - 8,7	2,2 - 12,9	3,6 - 10,8	3,5 - 17,6	3,5 - 17,6	2,7 - 10,8	2,9 - 8,7
Netpower kW min-max Naturalgas G20	2,1 - 6,1	2,9 - 7,9	2,6 - 7,6	3,6 - 10,8	3,2 - 9,7	2,2 - 12,9	3,2 - 16,1	3,5 - 17,6	3,5 - 17,6	2,7 - 10,8	2,6 - 7,6
Netpower kW min-maxPropaneG31	1,8 - 5,3	2,0 - 5,9	2,3 - 6,8	3,6 - 10,7	2,2 - 6,5	2,2 - 13,3	2,7 - 13,7	6,3 - 19,0	6,3 - 19,0	2,6 - 10,3	2,0 - 5,9
Return	83%	83%	84%	89%	83%	90%	90%	89%	89%	86%	88%
Energy label	<b>B</b>	<b>B</b>	<b>B</b>	<b>A</b>	<b>B</b>	<b>A</b>	<b>A</b>	<b>A</b>	<b>A</b>	<b>B</b>	<b>A</b>
Back wall - Black steel	●	●	●	●	●	●	●	●	●	●	●
Back wall - Black glass	○	○	○	○	○	○	○	○	○	○	○
Back wall - Roof tile motif	-	-	-	○	-	-	-	-	-	-	-
Fuel bed - Gas logs	●	●	●	●	●	●	●	●	●	●	●
Fuel bed - White Carrara pebbles	○	○	○	-	○	○	○	○	○	○	-
Fuel bed - White stones	○	○	○	-	○	○	○	○	○	○	-
Fuel bed - Grey stones	○	○	○	-	○	○	○	○	○	○	-
E-Save	●	●	●	●	●	●	●	●	●	●	●
ProControl via @pp	○	○	○	○	○	○	○	○	○	○	○
Convection grill(s)	○	○	○	○	○	○	○	○	○	○	○
Service hatch	○	○	○	○	○	○	○	○	○	○	○
Fuel pipe Ø (mm)	150/100	150/100	200/130	200/130	200/130	200/130	200/130	200/130	200/130	200/130	200/130
Power Fan	○	○	○	○	○	○	○	○	○	○	○
AR-glass	○	○	○	●	○	○	○	-	-	○	○

● = standard ○ = optional



	SUMMUM 100F	BIOPTICA	SKY T	TENORE 100	TENORE 140	TENORE 240H	BIDORE 70	BIDORE 100	BIDORE 140	BIDORE 240H	SUMMUM 70 C
Burner	Real flame	Single	Double	Double	Multi	Multi	Single	Single	Quad	Multi	Real flame
Type of fireplace	Front	See-through	See-through	See-through	See-through	See-through	Corner	Corner	Corner	Corner	Corner
Natural gas	●	●	●	●	●	●	●	●	●	●	●
Propane	●	●	●	●	●	●	●	●	●	●	●
Netpower kW min-max Natural gas G25	2,9 - 11,7	2,9 - 8,7	2,7 - 10,8	4,6 - 13,7	2,2 - 12,9	3,5 - 17,6	2,4 - 7,3	2,9 - 8,7	2,2 - 12,9	3,5 - 17,6	2,9 - 8,7
Netpower kW min-max Naturalgas G20	2,7 - 10,9	3,2 - 9,7	2,7 - 10,8	4,3 - 13,0	2,2 - 12,9	3,5 - 17,6	2,6 - 7,6	3,2 - 9,7	2,2 - 12,9	3,5 - 17,6	2,6 - 7,6
Netpower kW min-maxPropaneG31	2,9 - 11,5	2,6 - 7,8	2,6 - 10,3	4,3 - 12,8	2,2 - 13,3	6,3 - 19,0	2,3 - 6,8	2,2 - 6,5	2,2 - 13,3	6,3 - 19,0	2,0 - 5,9
Return	89%	80%	86%	89%	90%	89%	84%	83%	90%	89%	88%
Energy label	A	B	B	A	A	A	B	B	A	A	A
Back wall - Black steel	●	●	●	●	●	●	●	●	●	●	●
Back wall - Black glass	○	○	○	○	○	○	○	○	○	○	○
Back wall - Roof tile motif	-	-	-	-	-	-	-	-	-	-	-
Fuel bed - Gas logs	●	●	●	●	●	●	●	●	●	●	●
Fuel bed - White Carrara pebbles	-	○	○	○	○	-	○	○	○	○	-
Fuel bed - White stones	-	○	○	○	○	-	○	○	○	○	-
Fuel bed - Grey stones	-	○	○	○	○	-	○	○	○	○	-
E-Save	●	●	●	●	●	●	●	●	●	●	●
ProControl via @pp	○	○	○	○	○	○	○	○	○	○	○
Convection grill(s)	○	○	○	○	○	○	○	○	○	○	○
Service hatch	○	○	○	○	○	○	○	○	○	○	○
Fuel pipe Ø (mm)	200/130	150/100	200/130	200/130	200/130	200/130	200/130	200/130	200/130	200/130	200/130
Power Fan	○	○	○	○	○	○	○	○	○	○	○
AR-glass	○	○	○	○	○	-	○	○	○	-	○

● = standard ○ = optional



	SUMMUM 100 C	SUMMUM 70 3/S	SUMMUM 100 3/S	TRISORE 70	TRISORE 100	TRISORE 140	LUCIUS 100	LUCIUS 140	LUCIUS 240H
Burner	Real flame	Real flame	Real flame	Single	Single	Quad	Double	Quad	Multi
Type of fireplace	Corner	3-Sided	3-Sided	3-Sided	3-Sided	3-Sided	Room divider	Room divider	Room divider
Natural gas	●	●	●	●	●	●	●	●	●
Propane	●	●	●	●	●	●	●	●	●
Netpower kW min-max Natural gas G25	2,9 - 11,7	2,9 - 8,7	2,9 - 11,7	2,4 - 7,3	2,9 - 8,7	2,2 - 12,9	4,6 - 13,7	2,2 - 12,9	3,5 - 17,6
Netpower kW min-max Naturalgas G20	2,7 - 10,9	2,6 - 7,6	2,7 - 10,9	2,6 - 7,6	3,2 - 9,7	2,2 - 12,9	4,3 - 13,0	2,2 - 12,9	3,5 - 17,6
Netpower kW min-maxPropaneG31	2,9 - 11,5	2,0 - 5,9	2,9 - 11,5	2,3 - 6,8	2,2 - 6,5	2,2 - 13,3	4,3 - 12,8	2,2 - 13,3	6,3 - 19,0
Return	89%	88%	89%	84%	83%	90%	89%	90%	89%
Energy label	A	A	A	B	B	A	A	A	A
Back wall - Black steel	●	●	●	●	●	●	●	●	●
Back wall - Black glass	○	○	○	○	○	○	○	○	○
Back wall - Roof tile motif	-	-	-	-	-	-	-	-	-
Fuel bed - Gas logs	●	●	●	●	●	●	●	●	●
Fuel bed - White Carrara pebbles	-	○	○	○	○	○	○	○	○
Fuel bed - White stones	-	○	○	○	○	○	○	○	○
Fuel bed - Grey stones	-	○	○	○	○	○	○	○	○
E-Save	●	●	●	●	●	●	●	●	●
ProControl via @pp	○	○	○	○	○	○	○	○	○
Convection grill(s)	○	○	○	○	○	○	○	○	○
Service hatch	○	○	○	○	○	○	○	○	○
Fuel pipe Ø (mm)	200/130	200/130	200/130	200/130	200/130	200/130	200/130	200/130	200/130
Power Fan	○	○	○	○	○	○	○	○	○
AR-glass	○	○	○	○	○	○	○	○	-

● = standard ○ = optional

# LET OUR OTHER COLLECTIONS INSPIRE YOU

Element4 is a versatile and ambitious brand. We like to stay one step ahead and expand our range regularly with stylish newcomers. If you want, you can now equip all your favorite locations with an Element4 fireplace, whether it's your home, business premises or garden. Curious? Then take a look at our other collections!

 Please visit [www.element4.nl/en/brochures-1](http://www.element4.nl/en/brochures-1) and request the brochures



*Element4 always has the right fireplace for you.*



**ELEMENT**  
GAS FIRES

**4**



BROCHURE 2018

Paxtonstraat 23  
8013 RP Zwolle  
Netherlands

+31 (0)38 420 90 20  
info@element4.nl  
[www.element4.nl](http://www.element4.nl)