

morsø



morsø

Ø-Collection

Instructions for Installation and Use

Ø6 - (75% Efficiency)

Ø8 - (75% Efficiency)

UK/EN 13240



Distributed by: Morsø UK

Valley Drive · Swift Valley · Rugby, Warks CV21 1TW · England

MORSØ JERNSTØBERI A/S · DK-7900 NYKØBING MORS
E-Mail: stoves@morsoe.com · Website: www.morsoe.com

Enjoy your new Ø-COLLECTION stove!

Designed by Danish stove manufacturers Morsø, the Ø-Collection incorporates unique design features and, by carefully following the enclosed instructions we are certain that you will enjoy many years of safe, comfortable warmth from your stove.

Contents

		Page
1.0	Installing your Morsø stove	3
1.1	Unpacking the stove	3
1.2	Installing the stove	3
1.3	Chimney sweeping	3
1.4	Stove placement/distance requirements	3
1.5	The chimney	5
1.6	Pipe connections	5
1.7	Connecting to a masonry chimney	6
1.8	Connecting to a steel chimney	6
1.9	Draft conditions	7
2.0	Firing the stove	8
2.1	Lighting instructions and fuelling intervals	9
3.0	Routine stove maintenance	13
3.1	External maintenance	13
3.2	Internal maintenance	13
3.3	Cleaning the stove	14
4.0	Alternative fuel types	15

Additional accessories

A comprehensive line of floor plates and accessory products that can facilitate the safe and efficient operation and maintenance of your stove, are available from your approved Ø-Collection Dealer.

1.0 Installing your Morsø stove

1.1 Unpacking the stove

Carefully lift the stove from the wooden pallet and set it carefully in place.

We recommend that two people perform the assembly and installation procedure. Ø6 weighs 104, kg and Ø8 weighs 132 kg.

The stove is intended for intermittent use.

1.2 Installing the stove

The stove and chimney installations MUST comply to all current National and Local Building Regulations; your approved Ø-Collection dealer or your local building control officer can advise regarding this. Ultimately, it is you and your installer who is responsible that the installation complies.

1.3 Chimney sweeping

It may also be wise to consult your local chimney sweep before installing the stove. After your stove has been installed, it is advisable to have the chimney checked and swept at least once a year. In any case, if your chimney has not been used for some time, it should be inspected for deterioration, bird nests, etc. before it is put back into use.

1.4 Stove placement/clearance requirements

Clearance requirements apply only if the stove is placed near to combustible materials. Permitted clearances to combustible materials are also indicated on the data plate on the rear of the stove.

Clearance Distance to combustible materials:

Model	Behind the stove (A)	To the sides of the stove (B)	Above the stove	To soft furnishings
Ø6 uninsulated flue	700 mm	600 mm	600 mm	1100 mm
Ø8 uninsulated flue	850 mm	550 mm	600 mm	1100 mm

Ø6

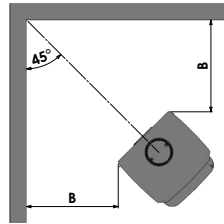
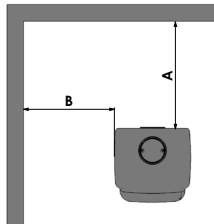

Ø8

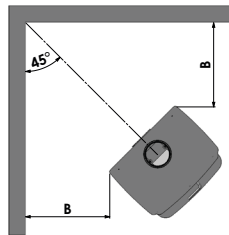
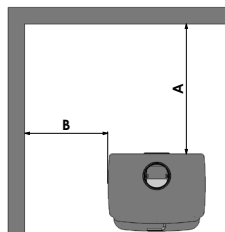

In situations where the stove is to be fitted into a brick or non-combustible recess, we recommend that the stove is installed with at least 10 cm clearance to the wall, this will allow room air to circulate around the stove; also the maintenance of the outside stove is easier. When applied to masonry, a layer of wallpaper is normally classified as a non-combustible surface.

Clearance to combustible surfaces in front of stove:

Model	Distance to combustible materials in front of the stove
Ø6	1100 mm.
Ø8	1100 mm.

The clearances stated above are minimum distances, but consideration ought to be given to whether furniture or other items can be affected by heat.

A wood-burning stove gets hot when it is fired. The necessary caution must therefore be observed, particularly where children or the infirm are present.

Hearth requirements:

The stove MUST be fitted in accordance with Local and National Building Regulations.

The O-serie stoves has been independently certified.

During the safety test the floor temperature did not exceed 100°C. The stoves may therefore be placed onto a hearth made of non-combustible board/sheet material or tiles at least 12 mm. thick.

Consideration should also be given as to the stove weight to ensure that the underlying floor is able to bear the weight

The handle will get hot when the stove is in use, for this reason a safety mitten is provided.

1.5 The chimney

Only if National or Local Regulations permit are you permitted to connect a stove into a chimney that is shared by another appliance. YOU MUST be aware of any applicable Regulations in this respect.

The wood-burning stove must never be connected to a chimney to which a gas-burning stove or appliance is connected.

An efficient modern stove places heavy demands on the chimney, and you should have the chimney regularly swept and inspected by your approved chimney sweep.

The cross-sectional area of the chimney (at its narrowest point) must comply with National and Local Building Regulations. Generally, the area needed for an Ø-Collection wood-burning stove installation should measure at least 175 cm² (150 mm diameter).

An over-sized chimney is generally hard to keep warm and results in poor draft. In cases where there is an oversized masonry chimney, it is recommended that the chimney be lined using an appropriately chimney lining system with the correct internal diameter.

With respect to the chimney termination, all chimneys should terminate in accordance with National and Local Building Regulations.

Note that National and Local Regulations also apply with regard to the placement of chimneys and flues in connection with thatched roofs. See the section on Draft Conditions, 1.9.

The chimney or flue system must be equipped with access doors for inspection and cleaning doors. The size of the cleaning door in the chimney must at least equal that of the cross-sectional area of the chimney.

1.6 Pipe Connection

Your stove is supplied ready for a top flue connection (4). The rear flue outlet is fitted with a cover plate and is situated on the back panel. Where a rear flue installation is required, unbolt the flue collar. Unbolt the cover plate and install it onto the top of the stove. The flue collar can then be bolted over the rear flue outlet using the bolts and clamps provided.

Make sure that the baffles (2 and 3), the firebricks, and the riddling grate are positioned correctly.

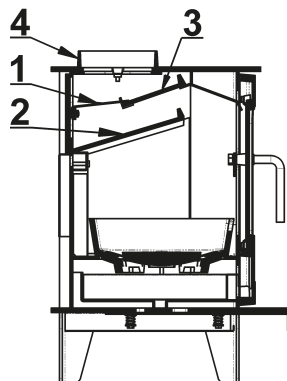

1.7 Connecting the stove to a masonry chimney

A wall sleeve should be bricked securely into the wall of the chimney at the appropriate height and the stovepipe inserted centrally. The pipe must not extend into the actual chimney opening, but rather must reach only to the inside of the chimney aperture. The gap between the stovepipe and sleeve must be sealed using glass fibre packing rope.

Only use stovepipe components that comply to National and Local Building Regulations.

1.8 Connecting to a stainless steel insulated chimney system

If your installation involves taking the chimney straight up and through the ceiling, you must comply with National, Local Building Regulations or flue manufacturers instructions concerning clearances to combustible materials such as walls, floor joists and ceilings. The joint between the stove flue collar and the stovepipe must also be sealed using the glass fibre rope provided. It is important that the insulated flue system is properly supported both at ceiling level and at roof level.

THE STOVE MUST NOT BEAR THE WEIGHT OF THE CHIMNEY SYSTEM (See chimney manufacturer's instructions). Excessive weight on the stove will inhibit expansion and could lead to damage of the stove top. Damage caused to the stove in this way would not be covered by the manufacturers guarantee.

In the event that a chimney fire occurs as a result of faulty operation or prolonged use of damp wood fuel, close the air vents completely and contact your local fire department immediately.

Be aware of the following:

Cleaning procedure: Discuss this with chimney sweep or qualified installer prior to or during the stove installation

Chimney draft: If the chimney draft is naturally poor it is better to install the flue from the top of the stove so as to minimise any internal resistance of the flue gases.

Avoid having any more than 2 bends in the flue system and limit the length of the offset between bends.

Fresh air supply

A wood-burning stove requires air for combustion and therefore you may need to install additional ventilation to the room, especially so in well insulated houses. If the air supply is inadequate the chimney draft may be too weak, with the possible result that the stove will not burn properly; smoke spillage may also occur during the refuelling process.

On a positive note, a properly installed wood-burner will give even the most efficient houses a pleasant and natural ventilation.

1.9 Draft conditions

If smoke spillage occurs when the fire door is opened, it is probably due to poor chimney draft. This type of stove requires at least 12 pa of chimney draft to achieve satisfactory combustion and smoke spillage prevention. However, in cases where the stove door is opened too vigorously you could expect that slight smoke spillage may occur.

If there is too much draft from the chimney, a damper device can be installed in the chimney to reduce the draft.

Please note that this damper device must not close the aperture area in the chimney entirely. There must be a clear opening of at least 20 cm² when the damper is closed.

If you have any doubts, you may want to have your installer measure the draft in the chimney.

Stove Type	The Flue Gas Temperature at the rated output is (°C) relative to 20° C	The Flue Gas Flow is (gr/sec.)
Ø6	300	7,6
Ø8	353	8,7

Draft conditions

The chimney's draft is the resulting effect within the flue caused by the difference in temperature within the flue and the cooler temperature outside. Other factors that can influence the level of draft include the length of the flue, insulation of the chimney, adverse weather conditions or tall buildings or trees nearby the flue terminal.

Poor draft occurs when:

- The atmospheric temperature difference is too low, e.g. a poorly insulated chimney. If the chimney is excessively cool, it may help to 'prime' the flue before the fire is lit. Just place a screwed-up sheet of newspaper in the flue-ways of the stove and ignite.
- The outside temperature is too high, e.g. during the summer months.
- There is no air movement (wind) outside.
- The chimney is not tall enough, with the result that the terminal sits in the lee of the roof surface or in the vicinity of tall trees or neighbouring buildings. These conditions are also associated with downdraft where the flue gases are pushed back down the chimney.
- Flue draft is diluted by residual air entering the chimney, e.g. due to inadequate flue-pipe joints or leaks at the cleaning door or flue collar.
- Unsealed, unused fireplaces are connected to the chimney.
- The flue is blocked, e.g. by soot, due to inadequate cleaning, loose debris or even a birds nest.
- The house is too tightly sealed (see section on Fresh air supply).

A good draft is achieved when:

- The temperature difference between the chimney and outside is high. This also applies during firing, when the need is greatest.
- The weather is clear and there is a good wind.
- The chimney is of the proper height, i.e. minimum 4 meters over the stove and the termination adequately clear of the roof line.

2.0 Firing the stove/Using your stove

The heat output of your stove is regulated by means of the 3 air inlets. A preheated air supplied to the fire across the glass window. The air is supplied when the handle under the ash lip is pushed right in.

Another air supply that passes through the shaking grate is used when fuel with low gas content (coke) is used. The air is controlled when the handle under the ash lip is pushed right out.

A third air supply is a constant supply of pre-heated air introduced into the firebox via the unique baffle system. This air supply helps to establish an even more complete combustion process of both fuel and gases. Control of this is factory fixed and cannot be adjusted by the user.

The riddling grate is controlled by the riddling arm behind the door.

Your new Morsø stove is EN-tested and recommended to be fired with wood.

The stove is intended for intermittent use.

N.B!

Wood is a material that contains a great deal of gas (approximately 75 %). The gases are released when the wood is lit and heated up. For this reason, it is important that the gases are ignited quickly after stoking.

If the wood just lies smouldering, especially after re-stoking, a lot of smoke is created, which, in the worst case, may cause an explosive ignition of the gasses, resulting in damage to the stove.

In order to ignite the gases that are released from the wood, and to keep clear, lasting flames during the combustion process, it is important to let in the required quantity of oxygen (air supply) at all times.

The setting of the air supply, the method of ignition and the lighting intervals depend on the draught in the chimney, the wind and weather, the amount of heat required, the fuel, etc. This means that it may take some time before you get to know the correct functioning of the stove under any given circumstances.

Although you can fire your Morsø stove with almost all kinds of wood, you should not fire with wet wood, or unseasoned wood. Wood ought to be stored under a roof for at least 1 year, and preferably 2 years, with free access to wind. Wood should be chopped as soon as possible after felling if it is to dry quickly. The wood can be used once the moisture content is less than 20%. During the official test, all stoves are tested with wood with a moisture content of 16% ± 2.

Never use driftwood, as it usually has a high salt content, which damages both the stove and the chimney. Impregnated and painted wood and chipboard emit poisonous smoke and fumes, so they should not be used as fuel either.

Please note that liquid fuel may not be used in the stove.

Pieces of wood with a diameter greater than 10 cm should always be chopped.

The pieces of wood should be short enough to be able to lie flat over the layer of embers, with air at both ends.

The maximum length of fuel in the stove is 32-34 cm.

The maximum quantity of fuel is 2.5 kg/hour (max. 3 pieces of wood each time you re-stoke).

The first few times you light the stove, the fire should be moderate, so that the heat-resistant paint can harden before firing more vigorously. During the hardening phase, the paint may develop obnoxious smoke and smell the first time it is lit, which is very normal. Make sure that the room is well ventilated during this period.

When heating up or cooling down, the material is exposed to major temperature differences that may cause the stove to give off creaking sounds.

The heating capacity of the stove is regulated with an air-slide control, positioned under the ash lip.

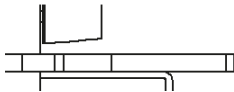
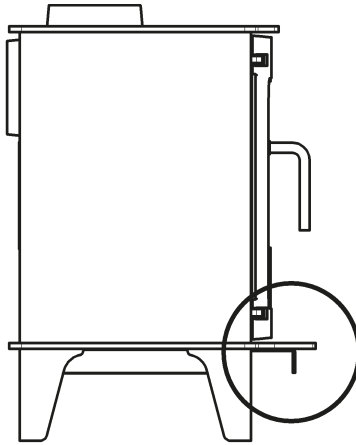

The secondary air supply is open and the primary air supply is closed.

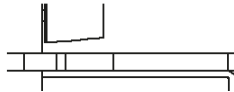

Both the primary and secondary air supply are closed.

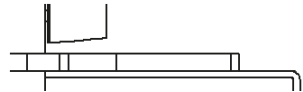

The primary air supply is open and the secondary air supply is sufficiently open for using alternative types of fuel.

Stove	Nominal Output (kW)	Efficiency %
Ø6	7,0	75
Ø8	9,0	72

Model	Maximum log length (cm)	Recommended weight per loading (kg.)
Ø6	35	2,0-3,0
Ø8	53	3,0-4,0

2.1 Lighting and fuelling intervals

A lot of air is needed when first lighting the stove. When starting with a totally cold stove, it may be helpful to leave the door ajar (2-3cm) during the first few minutes; the air intake should be fully open.

Wood fuel burns well when placed onto an ash bed on the grate of the stove. To achieve this you should burn roughly 1-2 kg of dry kindling the first time you light the stove. You should build and maintain the ash bed to a thickness of approximately 1 cm.

1. A layer of coals will form rapidly if the stove is lit with 2 - 4 fire lighters or 7 - 10 rolled up sheets of newspaper, underneath roughly 1 kg of dry kindling.



2. Fully open the the secondary air supply. Push the air control right in.



3. After the paper/firelighters have caught fire leave the fire door ajar 2-3 cm so that the chimney draws well.



4. After 5-10 minutes the chimney draft should be established, at this point close the fire door. If all the necessary conditions are met, a nice layer of embers will start to accumulate after another 15 - 20 minutes.



5. Refuelling of your stove should be done while there are still glowing embers in the bed. Spread the embers across the bottom, but concentrated mostly towards the front of the stove.



6. Place three pieces of fuel weighing roughly 0.6 kg and measuring about 25 cm in length across the embers in one layer, with spacing of roughly 1 cm between the pieces of wood. Recommended length and weight are shown on the diagram on page 9.



7. When the secondary air supply is opened all the way and the door is closed, the new fuel will ignite in a few minutes.



Important!

It is important that the fresh quantity of wood starts to burn quickly. To ensure the fuel lights quickly, open the combustion air to max. or leave the door ajar to allow in the amount of air needed to light the wood.

If, however, the wood only smoulders, there will be a strong build-up of smoke, which at worst can cause an explosive ignition of the flue gases with the risk of material damage and personal injury.



8. Once the new fuel has taken, adjust the secondary air amount to the desired setting; optimal combustion will continue until glowing embers are produced.

Make sure that there is always enough air (oxygen) to maintain clear, lasting flames when, and after, reducing the amount of combustion air.

Under normal chimney draft conditions, expect to re-fuel your stove every 60 - 70 minutes.

9. A new charge of wood can be added by repeating steps 5 & 6.



The stove door should normally be opened gently the first 2 - 3 centimetres, then you should wait until the pressure has equalised before opening the door all the way. This technique will prevent smoke from getting out, particularly when there is a poor draught. The stove door should never be opened when the stove is being fired vigorously.

Once the wood has burned out, it becomes glowing charcoal. If a good layer of embers has already formed on top of a sufficient layer of ash, the stove can keep warm for a very long time, not least due to the favourable qualities of the cast iron.

We would strongly recommend that you do not leave your stove alit at night. It harms the environment, and constitutes very poor use of the wood, as the gases in the wood do not ignite at the low temperature, but settle as soot (unburned gases) in the chimney and stove. Extreme conditions, such as poor draught in the chimney, large quantities of wood or wet wood, may, in the worst-case scenario, cause an explosive ignition.

When firing in the summer period, when there is minimal need for heat, the combustion will be poor. The stove provides too much heat, so the combustion should be reduced. But always remember to make sure that there are lasting flames until the wood becomes charcoal. If you want a weaker fire, stoke up using less wood.

If you fire the stove using wet wood, a lot of the fuel's thermal energy will be spent forcing the water out of the wood, without releasing any heat to the stove. This incomplete combustion results in a layer of soot being left in the stove, pipe and chimney.

Comparison between wood-burning and oil-burning

Type of wood (moisture content 20%)	No. of cubic metres per 1000 litre of Oil
Oak	7.0
Beech	7.0
Ash	7.2
Sycamore	7.5
Birch	8.0
Elm	8.9

3.0 Routine stove maintenance

3.1 External maintenance

The surface of the stove is painted with heat-resistant Senotherm paint. If the stove is used too vigorously, the painted surface may take-on a greyish tinge. It is easily maintained by simply vacuuming the surface with a soft brush attachment and applying two light layers of paint.

Ø-Collection stoves are painted using a Morsø Original Black (previously called Morsø dark grey) or Morsø grey. The paint can be bought in a spray or a can.

3.2 Internal maintenance

Ceramic glass

If the stove is used and installed onto a flue with the correct draft, very little or no deposits should appear on the ceramic glass. It is usual for soot deposits to appear during long slumbering fires however, once the fire has been re-established to a burn brightly, these deposits should burn off.

If the glass window becomes thoroughly covered in soot due to faulty operation or poor draft, the soot can be easily removed using, e.g. Stove Glass Cleaner, but please ensure that the glass is cold before cleaning. Avoid fuelling the stove with wood so long that it presses against the glass when the door is closed.

Reasons for sooted glass window:

- **fuel is too wet (green)**
- **pieces of fuel/uncut wood are too thick**
- **operating temperature of the stove is too low**
- **too much air coming through bottom grate**
- **POOR FLUE DRAFT**

Ceramic glass replacement

Ceramic glass cannot be recycled because it has a higher melting point than ordinary glass. If ceramic glass is mixed with ordinary glass, the raw material is spoiled, and the reclaiming process may be halted. Take care that the ovenproof glass does not end up among ordinary recycled waste. That will be a great benefit to the environment.

Note: Should be handed in to a recycling station as ceramic glass.

Internal cast-iron parts and/or wear components

The shaking grate, baffle plate and other internal components that are in direct contact with the fire are all constituted as 'wear' components or consumables, as they are exposed to the most wear. When used properly, these parts will last for many years, but overly vigorous use will naturally shorten the lifespan. The aforementioned parts are all easily replaceable.

If the baffle plate is damaged or warped and is not replaced in time, the top plate could become subject to excessively high temperatures, which may lead to damage here also.

Note: that no unauthorised alterations to the stove design should be undertaken, and always ensure that any replacement parts purchased must be Ø-Collection original parts.

Reasons for premature wear of internal parts

- **Stove being used/fired too vigorously**
- **Too much air passing through the bottom grate**
- **Use of excessively dry wood (wood from old furniture)**
- **Excessive debris collection on baffle plate or inner fireback (see section on cleaning)**
- **Ash level too high in the ash pan (see section on ash).**

Gaskets

The rope gaskets in the door will need regular inspection in order to ensure and maintain full control of your stove's burning rate; over time the rope gaskets will harden and will become less airtight; at this point you will need to remove and replace with new. Use only the genuine gasket kit, which comes with detailed replacement instructions.

NOTE:

Normal wear components (inner parts) are not covered by Manufacturer's Guarantee

Maintenance products (Spare Parts, Glass Cleaner, Paint, Gasket Kit, etc) are all available from your authorised Ø-Collection dealer.

3.3 Cleaning the stove

During normal use and sweeping of your stove and chimney, a layer of ash, soot or debris can form, particularly on the top of the baffle plate. Any deposits allowed to build-up over time will have an insulating effect on these parts, thus restricting expansion; this ultimately will result in a shorter lifespan. The chrome-iron baffle plate and bricks can easily be removed from the stove and should be regularly checked for debris and cleaned. You must ensure that your chimney sweep removes all soot and debris from the stove after the sweeping process.

Your chimney should be swept at least once a year; however a regular inspection of your stovepipe and chimney will determine whether a more frequent approach should be adopted.

Ash

In order to achieve the highest combustion temperature possible when burning solely wood, it is important that a 1cm deep bed of ash is established on top of the grate area. Excess ash should be removed by simply agitating the grate by moving the riddling rod on the outside of the stove; surplus ash will fall into the ash pan below the grate where it can be easily and safely removed.

Be sure to empty the ash pan before it gets completely full; if the ash level reaches the underside of the grate, air flow through the grate will be restricted and will lead to over-heating and premature wear of the grate parts.

When emptying the ash pan always dump the waste ash into a metal container (dustbin) where it can fully cool before being taken away by your refuse collector. Ash from a wood-burning stove does not benefit your garden as fertiliser.

4.0 Alternative fuel types

Your new Ø-Collection stove is EN-approved for burning wood.

However, the stove is capable of burning other solid fuels as manufactured smokeless coal or good quality anthracite (stove nuts).

BITUMINOUS HOUSE COAL SHOULD NEVER BE USED IN YOUR STOVE.

Before burning solid fuel

Install the chrome iron basket into the firebox.

Lighting with solid fuel

All air vents must be fully open during the lighting process.

Start by placing 5-10 crumpled sheets of newspaper or 2 firelighters on the grate of the stove; then carefully spread approximately 1 kg of well-dried kindling on the top. Light the paper/firelighters. Once the kindling has fully ignited, gradually add a small quantity of solid fuel, adding a little bit more once it has ignited. Continue in this manner until the entire grate is covered with glowing coals. The level of fuel in the stove should never exceed the level of the front grate. Once the bottom half of the fuel bed is glowing, you should partly close the bottom vent (on the ash pit door). Once the stove has reached your desired temperature you can maintain the output by opening further for more heat or closing for less heat. The secondary air regulator must always be open just enough so that the flames burn almost clearly and the ceramic glass window stays clean.

Note: In cases where smokeless fuels containing petrocoke are burned, a pale greyish layer may be deposited on the inner glass surface when the stove is lit. Fuels containing a high content petrocoke may cause a glistening in the surface of the ceramic glass. Although visible, the structure of the glass will remain intact and the stove safe. Glass affected in this way is not covered by manufacturer's guarantee.

In order to maintain the combustion process, the entire grate area must remain covered by glowing coals. If the coal layer is too shallow you will have less heat.

You must empty the ash pan whenever it becomes full. Different fuels have different ash content and therefore the regularity of the de-ashing process can vary.

Fuel storage

Your fuel supply should always be stored in a suitable, weather-tight coal bunker. These are usually available through your approved coal merchant.

MaintenanCE parts for Ø-Collection

Description	Product Code	
	Ø6	Ø8
Riddling Grate	44162500	44162500
Coal insert	33000400	33000400
Grate Frame	33000500	33000900
Baffle, lower	33001100	33008800
Baffle, upper	33002000	33008900
Draft Reducer	-	-
Glass	79000200	79000300
Tertiary Baffle	73002561	73004361
Back brick	79001000	79004700
Side brick	79001200	79004800

Guarantee Product Registration

MORSØ 10 YEAR GUARANTEE CERTIFICATE

Behind every Morsø stove is more than 160 years of dedicated stove design and manufacturing experience. Quality control has always been at the heart of the production process and detailed measures have been put into place at all key stages of the build. Accordingly, provided that the stove has been supplied by an authorised Morsø dealer, Morsø will offer a 10-Year Manufacturers Guarantee against manufacturing defect to any of the main exterior body parts of its stoves.

**Read more about "Morsø 10 years guarantee/product registration card" and
REGISTER your new Morsø stove online:
<http://international.morsoe.com/warranty-registration>**

IMPORTANT!

How to heat safely for the environment and yourself!

- **Use only dry wood**

Use only dry (max. 20% moisture content) and untreated wood. The fuel must be split and 8 - 12 cm thick.

- **Light**

Light with dry kindling (use 1 - 2 kg). Leave the door ajar and stay close to the stove during the lighting phase.

- **Good layer of embers**

Be certain to have a good layer of embers before refilling. The wood should light within 2 minutes. If the logs do not ignite it may, in an extreme case, cause the flue gases to ignite which may pose a risk to material damage or personal injury.

- **Refuelling**

When refuelling use 2 - 3 pieces of wood - no more than 2 - 2,5 kg.

- **Ensure adequate air**

I.e. clear and yellow flames.

- **Never burn overnight**



By appointment to The Royal Danish Court

morsø

Morsø Jernstøberi A/S - 06.06.2016 - 72000400