

Clover

Gentle Polar Bear Pom-Pom

Designed by Reimi Yoshitani



**Make Cute
Accessories!**



Sign up at www.clovertoolschool.com

Supplies

- **Pom-Pom Makers - Art No. 3126, 3127, 3129**
 - **1 inch (25 mm)**
 - **2 ½ inch (65mm)**
- **Patchwork Scissors - Art No. 493/CW**
- **Pen Style Needle Felting Tool - Art No. 8901**
- **Needle Felting Mat - Art No. 8910 & 8911**
- **Stitching Needle**

Materials

- **Size 4 - Medium (Worsted) White Yarn**
- **Natural Wool Roving (Black) - Art No. 7932**
- **Natural Wool Roving (Ash) - Art No. 7933**
- **2 Plastic Safety Eyes (5 mm round)**
- **Keychain or Brooch Pin**
- **Craft Glue**

How to Make

**For more detailed instructions on how to use Pom-Pom Makers, please refer to the instructions included with the product.*

Head:

1. Wrap the yarn around the 2 ½ inch Pom-Pom Maker in the order as shown in the diagram:

Keychain:

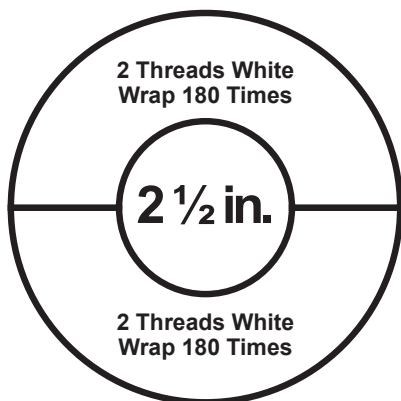

Brooch:

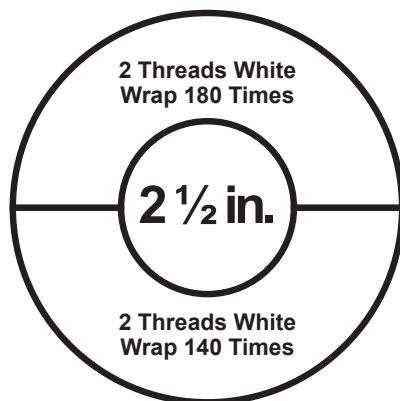

**Note: The back of the brooch will be easier to use if you reduce the amount of times you wrap the yarn.*



2. Cut the thread wrapped around the arches of the Pom-Pom Maker. Be careful not to leave anything uncut.

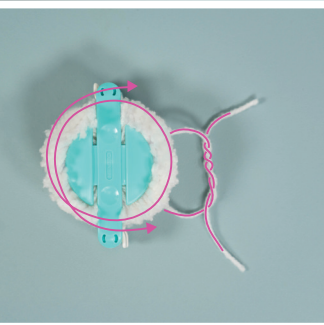

3. Wrap about 16 inches of yarn around the Pom-Pom maker twice, pull the yarn tightly, and tie it twice.

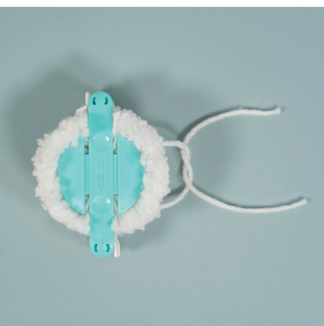

4. Tie one more knot to secure the Pom-Pom.



5. Open one arch at a time on both sides.



6. Carefully pull both sides of the Pom-Pom maker apart to release the Pom-Pom head.

Ears (Make 2):

- 1. Use a 1 inch Pom-Pom Maker for the ears.
Follow the diagram as shown:**

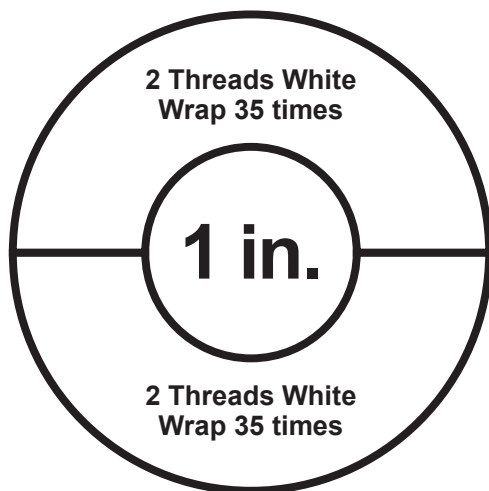

- 2. Repeat Steps 2-5 from making the “Head.”
However, for Step 3 wrap about 10 inches
of yarn around the Pom-Pom Maker
instead of 16 inches.**

Snout:

1. Use a 1 inch Pom-Pom Maker for the snout.
Follow the diagram as shown:

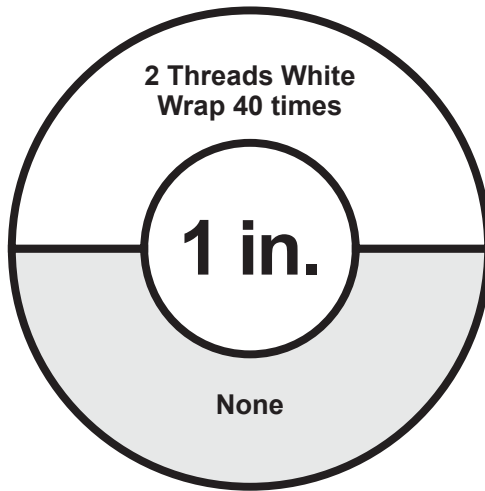

It's half a Pom-Pom!

2. Repeat Steps 2-5 from making the "Head."
However, for Step 3 wrap about 10 inches
of yarn around the Pom-Pom Maker
instead of 16 inches.

Trimming

Trim each part as described.

Head Dimensions:

Front View

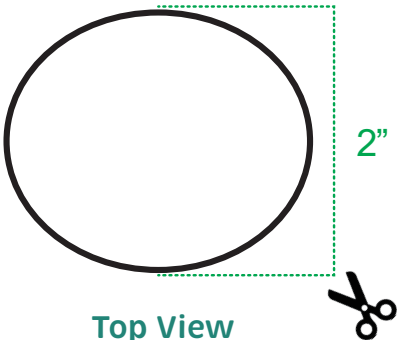
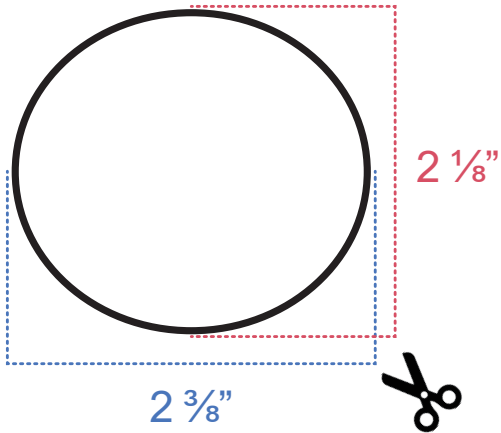

Top View
(Keychain)

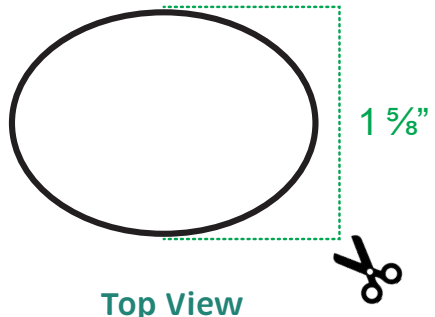

Top View
(Brooch)

Ear Dimensions:

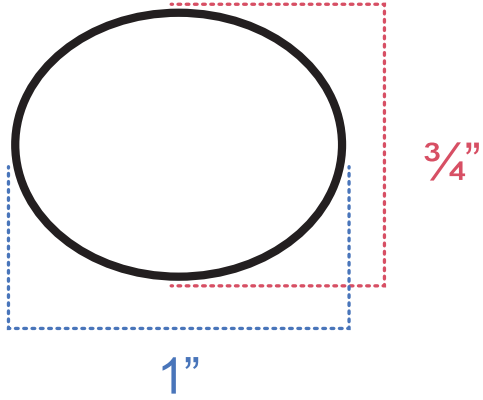

Snout Dimensions:

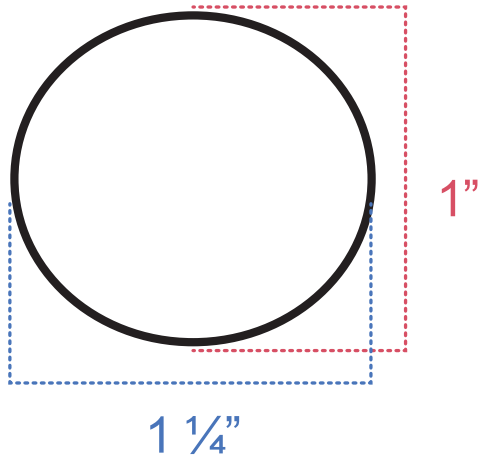

Assembly

1. Connect the snout to the head with a stitching needle. Tie knot through the head and harden the knot with the Pen Style Needle Felting Tool (3 needles). Cut off excess yarn.

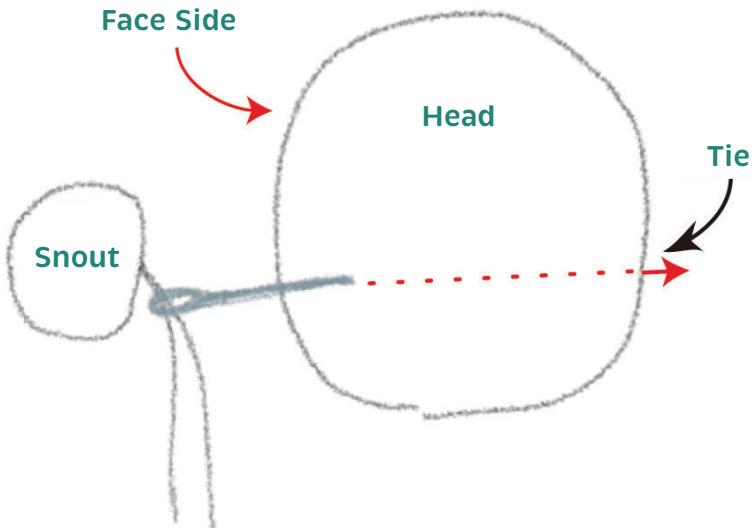

**Note: If you are making the brooch, make sure to place the snout on the thicker side of the head.*

2. Shape the snout by stabbing all around the snout about 400 times with the Pen Style Needle Felting Tool (3 needles).



3. Create small holes in the head, just above the snout, for where you would like to place the eyes. Apply glue to the safety eyes and insert them into the holes of the Pom-Pom.

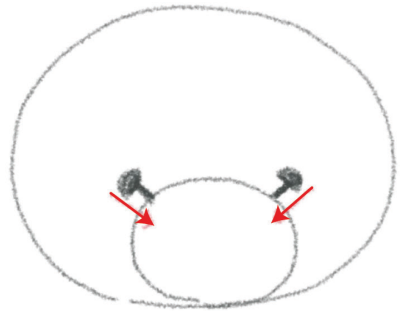

**Note: If you insert the eyes at a slight angle, it will look cuter!*

4. Place some black wool in the center of the snout to create the nose and mouth. Use the Pen Style Needle Felting Tool (1 needle) to shape them to your liking.

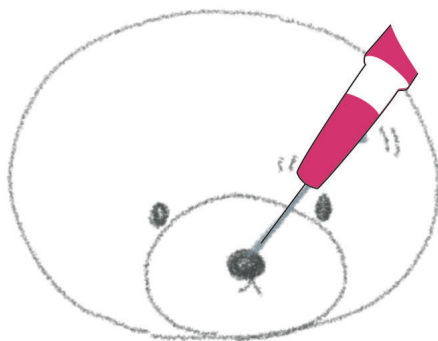

5. Attach the ears with a stitching needle. Tie the threaded yarn tightly through the head together twice. Cut off the excess yarn.

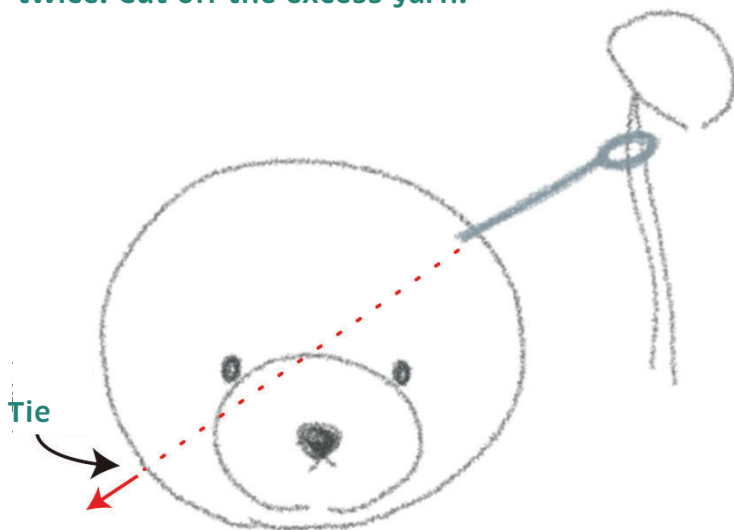

- 6.** Place some gray wool onto the ears and use the Pen Style Needle Felting Tool (1 needle) to shape the inner ears to your liking.

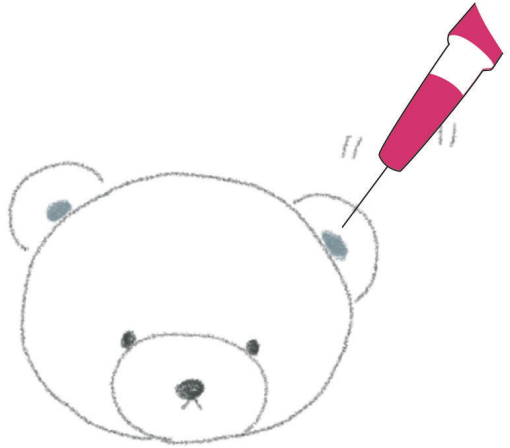

- 7.** Return the Pen Style Needle Felting Tool to 3 needles. Starting from the center of the head, punch around the eyes in an upward motion to adjust the shape of the forehead.



8. Attach the keychain with a stitching needle or attach the brooch pin to the back with glue. Trim any protruding yarn.





Finished!





CN CLOVER NEEDLECRAFT, INC.

1441 S Carlos Ave. Ontario, CA 91761

Tel: (800) 233-1703 Fax: (909) 218-2161

www.clover-usa.com www.clovercatalog.com

Find Us on Social Media:

 blog.clover-usa.com

      @cloverusa

NOV. 2023

CT0238