

Indoor Luminaire Photometric Data

Description Information

Lum. Name: LGDLR15WCCT-WH	Lum. Catalog: LED DOWNLIGHT	Test ID:
Lamp Name: 6000K	Lamp Catalog: SMD2835	Test Date: 2019/08/10
Manufacture:	ShldAngle(°):	Test Machine:GON-2000
Test Lab:	Frequency(Hz):	Lamp CCT(K): Ra:
Lum. Size(W*L*H):0.130m*0.130m*0.068m	Lum. Area(m2):0.026	Lum. W(kg): 2.000
Test System: C, γ	Test Step: C=90.0 γ=5.0	Temp.(°C): 25
		Humidity(%):

Character Parameter

Lamp Speciality Parameter		Luminaire Speciality Parameter	
Rated Flux(lm): 1108.340	Luminaire Flux: 1108.343lm	Field Angle(10%Imax): 129.6	
Rated Power(W):	Luminaire Efficiency: 100.00%	Down Lumens&Percent: 1108.006lm 99.97%	
Rated Voltage(V):	Luminaire EER(lm/W): 72.064	Up Lumens&Percent: 0.337lm 0.03%	
Tested Power(W): 15.380	Max. Cand. (cd): 585.247	S/MH: C0_a180=1.147 C90_270=1.146	
Lamps' Inside: 1	Max Cand@Ang. (°): C=270.0 γ=5.0	CIE Type: Semi-Direct	
Tested Electric:U=237.8V, I=0.067A, PF=0.000	Beam Angle(50%Imax): 86.0	ErP Φuse(90°): 781.732lm	
Lamp Size(W*L*H):0.130m*0.130m*0.068m	Left=-40.2 Right=45.9	IRF: 133.198%	

Lighting Distribution Diagram

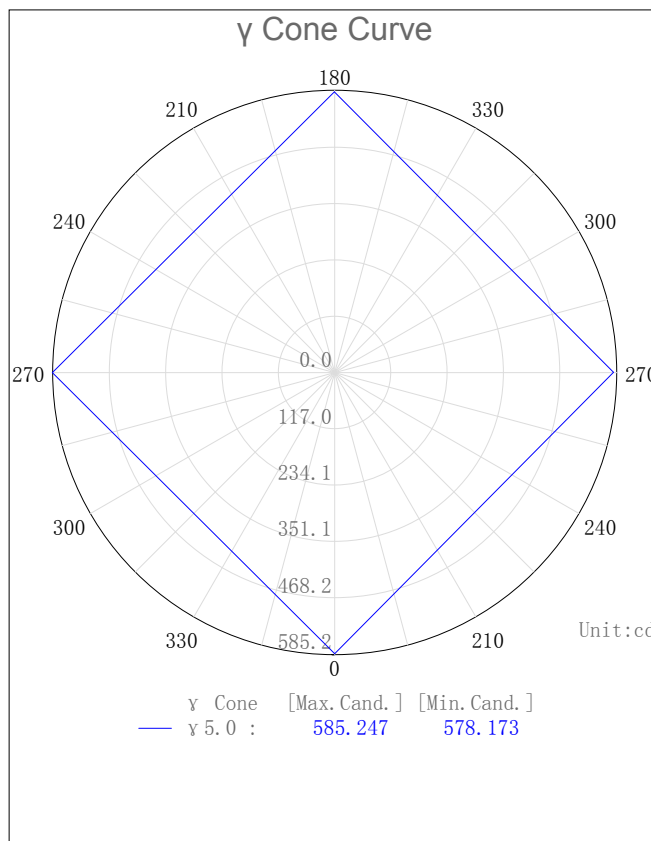
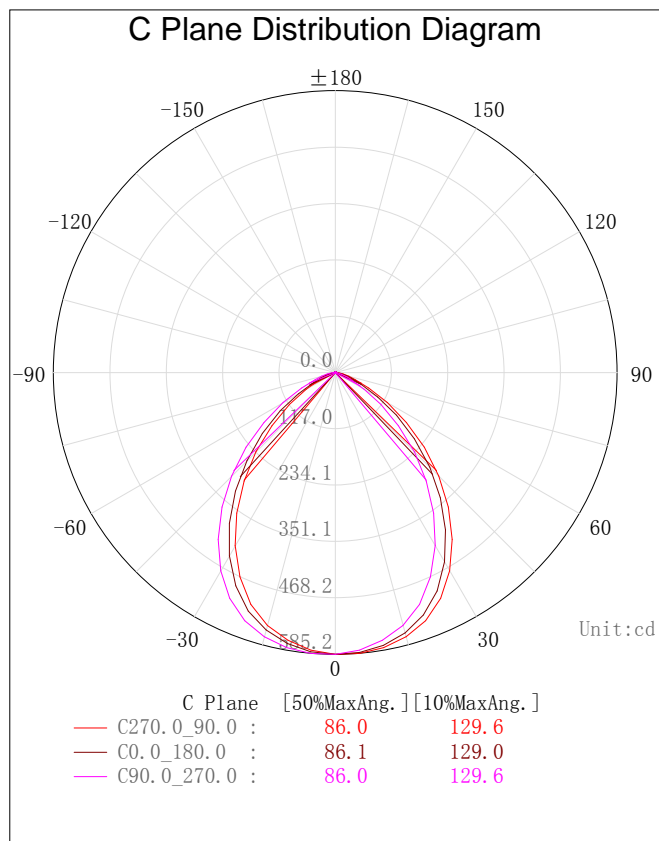

IES Indoor Report

Photometric Filename:LGDLR15WCCT-WH 6K.IES

3D Light Intensity Distribution Modal

Lum. Name: LGDLR15WCCT-WH	Lum. Catalog: LED DOWNLIGHT	Test ID:
Lamp Name: 6000K	Lamp Catalog: SMD2835	Test Lab:
Manufacture:	Test Machine:GON-2000	Test Date: 2019/08/10

3D Light Intensity Distribution Modal

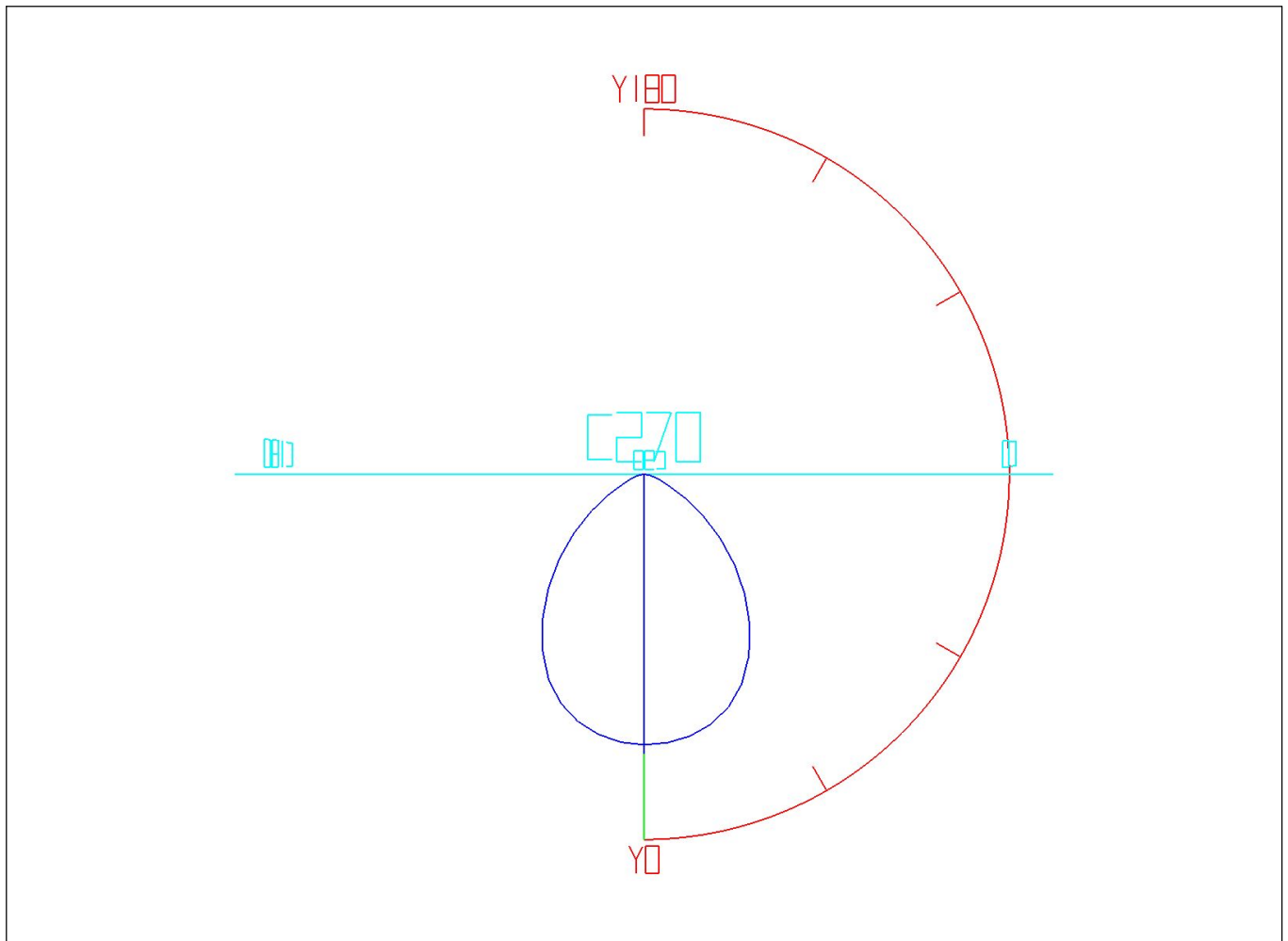

Curves: 3D Model ——— Fixture ——— Vert. HUD ——— Hori. HUD ———
View Angles: Orient:0 Tilt:0 Roll:0 Spin:0

IES Indoor Report

Photometric Filename:LGDLR15WCCT-WH 6K.IES

Zonal Flux Tabulation

Zone (y)	Zone Flux (lm)	Sums Flux (lm)	Zone%Lamp	Sums%Lamp
0.0-5.0	13.95	13.95	1.26	1.26
5.0-10.0	41.30	55.25	3.73	4.99
10.0-15.0	66.94	122.20	6.04	11.03
15.0-20.0	89.55	211.74	8.08	19.10
20.0-25.0	107.40	319.15	9.69	28.80
25.0-30.0	118.87	438.02	10.72	39.52
30.0-35.0	123.10	561.11	11.11	50.63
35.0-40.0	120.16	681.27	10.84	61.47
40.0-45.0	110.75	792.02	9.99	71.46
45.0-50.0	95.87	887.89	8.65	80.11
50.0-55.0	76.97	964.85	6.94	87.05
55.0-60.0	56.26	1021.12	5.08	92.13
60.0-65.0	36.96	1058.08	3.34	95.47
65.0-70.0	22.96	1081.05	2.07	97.54
70.0-75.0	14.55	1095.59	1.31	98.85
75.0-80.0	8.40	1104.00	0.76	99.61
80.0-85.0	3.39	1107.38	0.31	99.91
85.0-90.0	0.62	1108.01	0.06	99.97
90.0-95.0	0.00	1108.01	0.00	99.97
95.0-100.0	0.00	1108.01	0.00	99.97
100.0-105.0	0.00	1108.01	0.00	99.97
105.0-110.0	0.00	1108.01	0.00	99.97
110.0-115.0	0.00	1108.01	0.00	99.97
115.0-120.0	0.00	1108.01	0.00	99.97
120.0-125.0	0.00	1108.01	0.00	99.97
125.0-130.0	0.00	1108.01	0.00	99.97
130.0-135.0	0.00	1108.01	0.00	99.97
135.0-140.0	0.00	1108.01	0.00	99.97
140.0-145.0	0.00	1108.01	0.00	99.97
145.0-150.0	0.00	1108.01	0.00	99.97
150.0-155.0	0.00	1108.01	0.00	99.97
155.0-160.0	0.04	1108.05	0.00	99.97
160.0-165.0	0.08	1108.13	0.01	99.98
165.0-170.0	0.10	1108.23	0.01	99.99
170.0-175.0	0.08	1108.31	0.01	100.00
175.0-180.0	0.03	1108.34	0.00	100.00

IES Indoor Report

Photometric Filename:LGDLR15WCCT-WH 6K.IES

Rectangle ISO Lighting Intensity Diagram

Lum. Name: LGDLR15WCCT-WH	Lum. Catalog: LED DOWNLIGHT	Test ID:
Lamp Name: 6000K	Lamp Catalog: SMD2835	Test Lab:
Manufacture:	Test Machine:GON-2000	Test Date: 2019/08/10

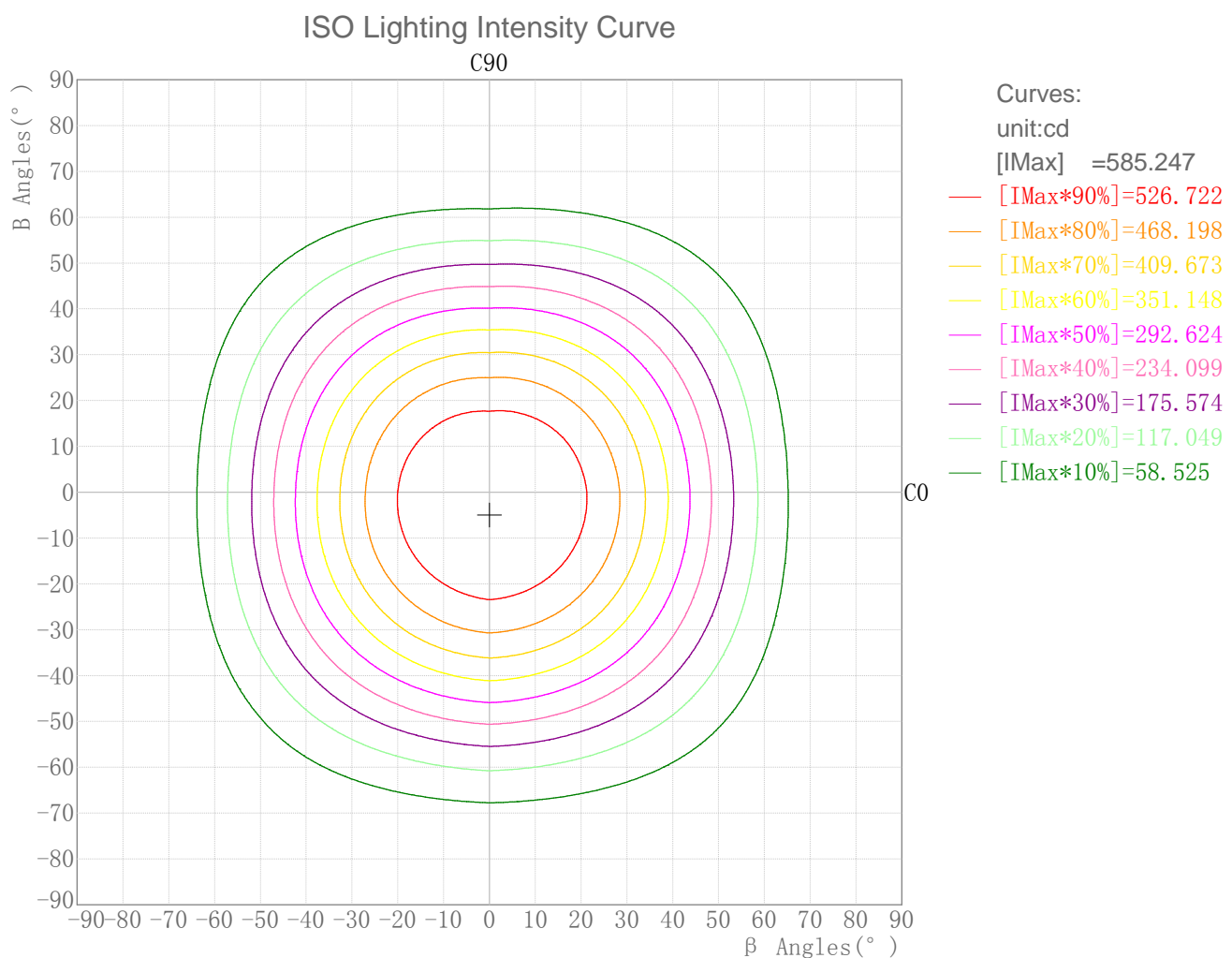

Maximum Light Intensity(cd): 585.25

Maximum Cand.@Angle: H=-0.0°,V=-5.0°

IES Indoor Report

Photometric Filename:LGDLR15WCCT-WH 6K.IES

Plane ISO-Illuminance Diagram

Lum. Name: LGDLR15WCCT-WH	Lum. Catalog: LED DOWNLIGHT	Test ID:
Lamp Name: 6000K	Lamp Catalog: SMD2835	Test Lab:
Manufacture:	Test Machine:GON-2000	Test Date: 2019/08/10

Plane ISO-Illuminance Curve

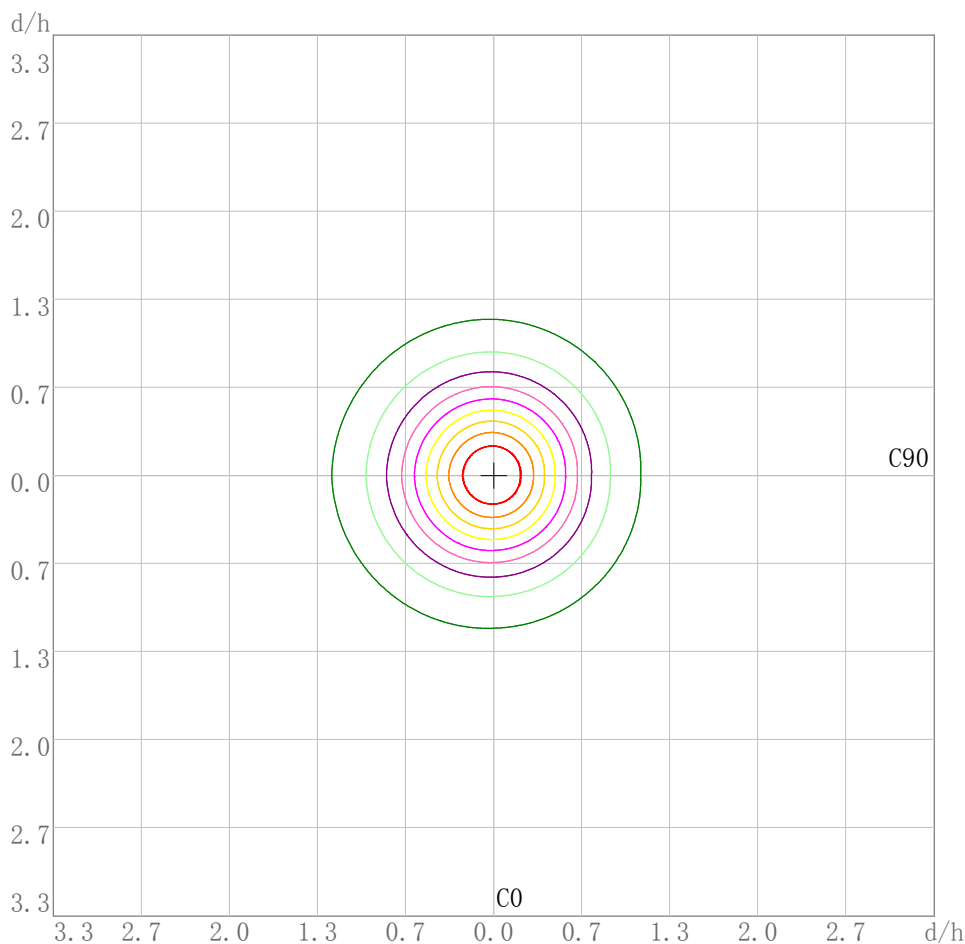

- Curves:
unit:lx
- [EMax] =65.014
 - [EMax*90%]=58.513
 - [EMax*80%]=52.012
 - [EMax*70%]=45.510
 - [EMax*60%]=39.009
 - [EMax*50%]=32.507
 - [EMax*40%]=26.006
 - [EMax*30%]=19.504
 - [EMax*20%]=13.003
 - [EMax*10%]=6.501

Working Plane Luminaire Mounting Height(m): 3.00
 Working Plane Maximum Illuminance(lx): 65.01
 Working Plane Maximum Illuminance Position(d/h):H0.0 V0.0

IES Indoor Report

Photometric Filename:LGDLR15WCCT-WH 6K.IES

3D Plane ISO Illuminance Diagram

Lum. Name: LGDLR15WCCT-WH	Lum. Catalog: LED DOWNLIGHT	Test ID:
Lamp Name: 6000K	Lamp Catalog: SMD2835	Test Lab:
Manufacture:	Test Machine:GON-2000	Test Date: 2019/08/10

3D Plane Illuminance Modal

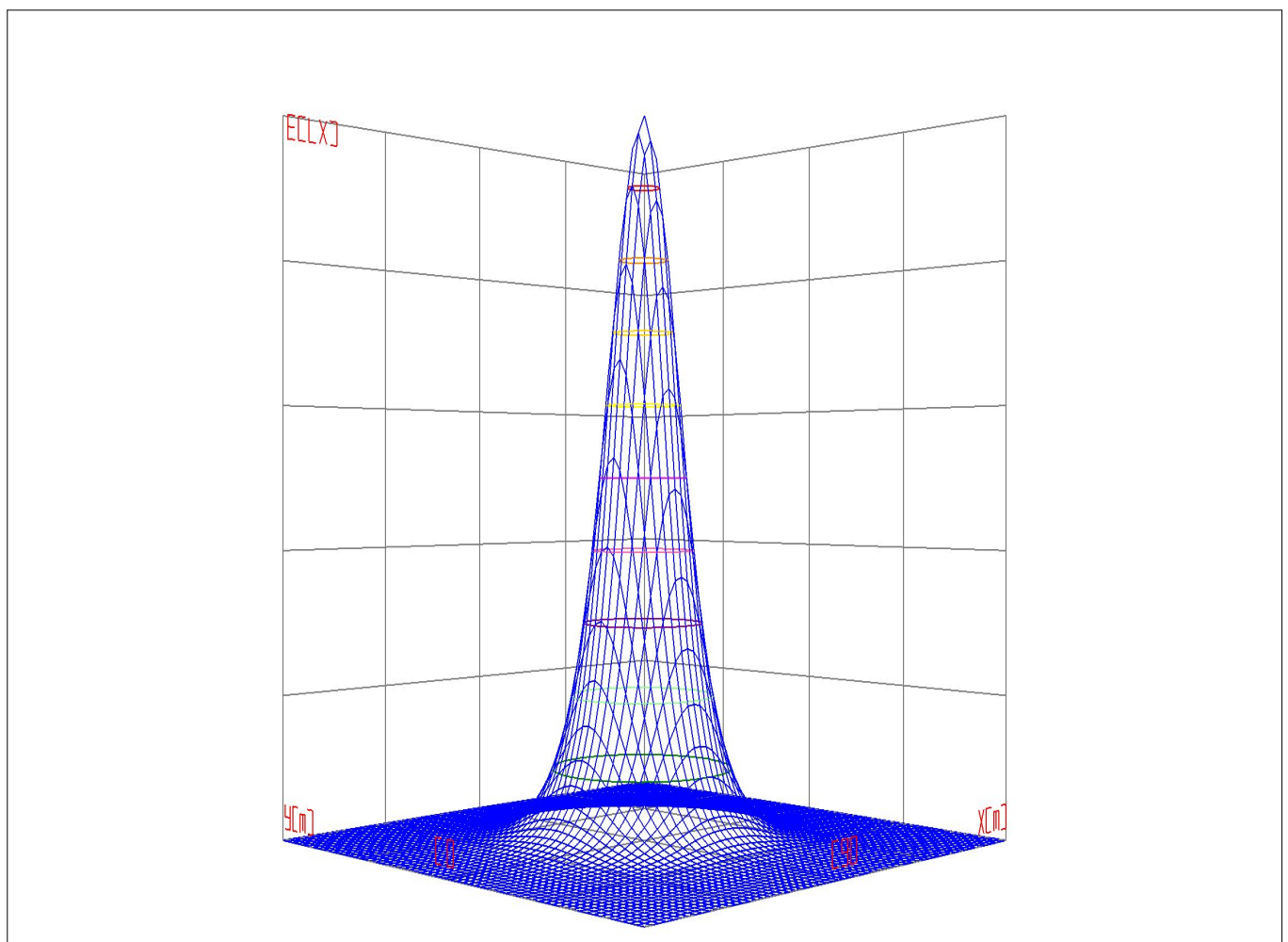

Curves: 3D Model — 90% — 80% — 70% — 60% — 50% — 40% — 30% — 20% — 10% —
View Angles(deg): 0 Height(m): 3.0 Distance(m): 10.0

IES Indoor Report

Photometric Filename:LGDLR15WCCT-WH 6K.IES

Space ISO Illuminance Diagram

Lum. Name: LGDLR15WCCT-WH	Lum. Catalog: LED DOWNLIGHT	Test ID:
Lamp Name: 6000K	Lamp Catalog: SMD2835	Test Lab:
Manufacture:	Test Machine:GON-2000	Test Date: 2019/08/10

Space ISO Illuminance Curve

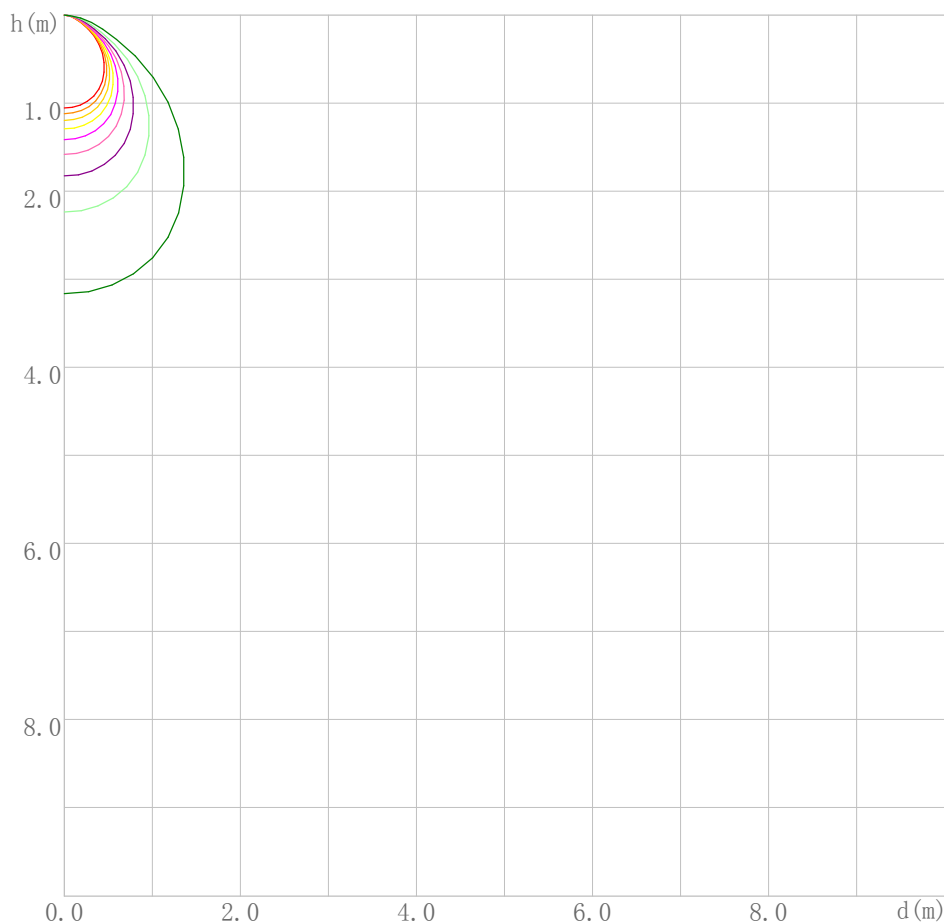

- Curves:
unit:lx
[EMax] =585.130
- [EMax*90%]=526.617
 - [EMax*80%]=468.104
 - [EMax*70%]=409.591
 - [EMax*60%]=351.078
 - [EMax*50%]=292.565
 - [EMax*40%]=234.052
 - [EMax*30%]=175.539
 - [EMax*20%]=117.026
 - [EMax*10%]=58.513

Space Plane Maximum Illuminance and @Angle:585.13,0.0deg
Plane Maximum Lighting Intensity and @Angle:585.130cd,0deg

IES Indoor Report

Photometric Filename:LGDLR15WCCT-WH 6K.IES

Illuminance-Distance Diagram

Lum. Name: LGDLR15WCCT-WH	Lum. Catalog: LED DOWNLIGHT	Test ID:
Lamp Name: 6000K	Lamp Catalog: SMD2835	Test Lab:
Manufacture:	Test Machine:GON-2000	Test Date: 2019/08/10

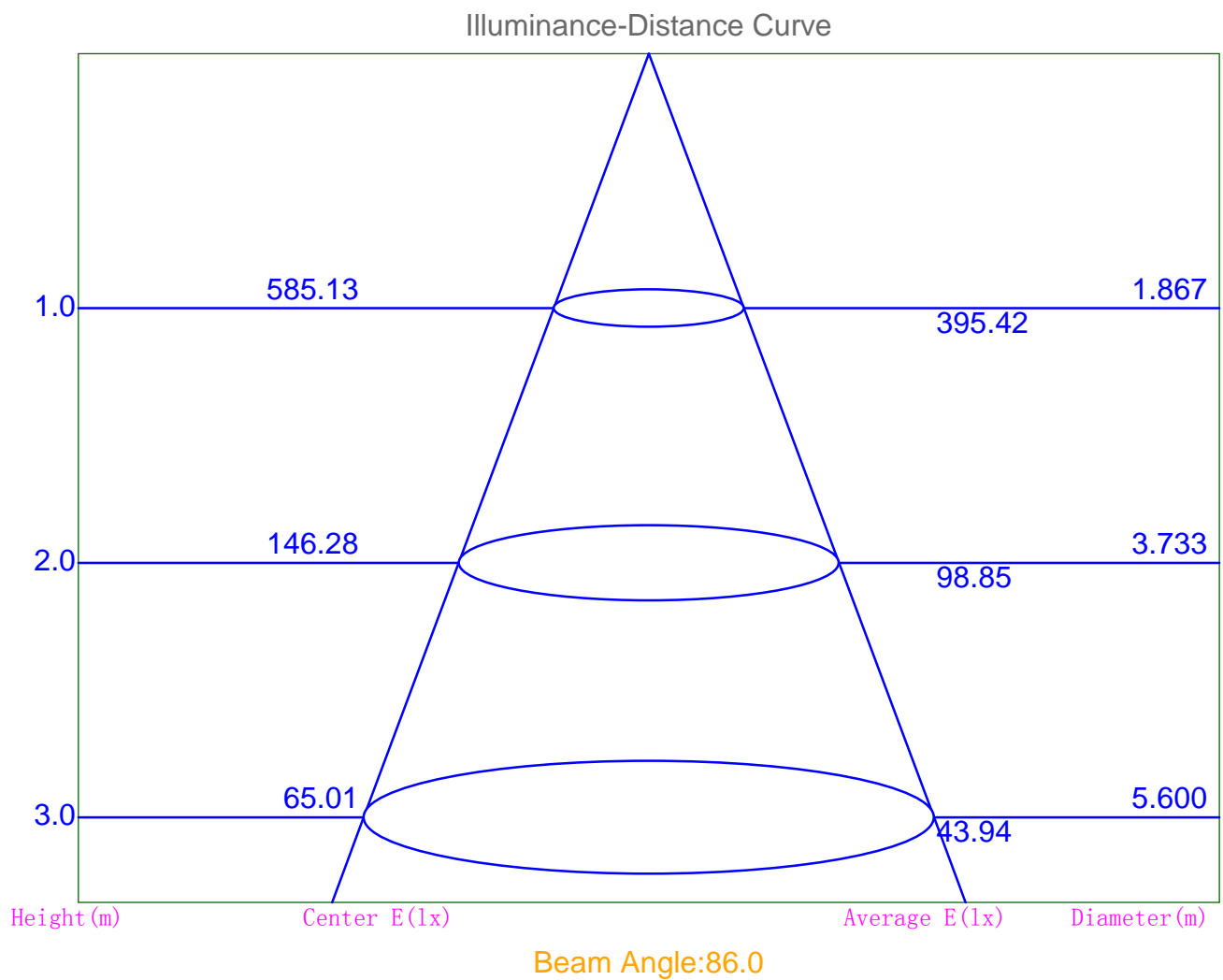

IES Indoor Report

Photometric Filename:LGDLR15WCCT-WH 6K.IES

Indoor Luminance Limiting Curves

Lum. Name: LGDLR15WCCT-WH	Lum. Catalog: LED DOWNLIGHT	Test ID:
Lamp Name: 6000K	Lamp Catalog: SMD2835	Test Lab:
Manufacture:	Test Machine:GON-2000	Test Date: 2019/08/10

Glare Grade Table

GI	Quality	Using Illuminance							
		a	b	c	d	e	f	g	h
1.15	A	2000	1000	500	<=300				
1.5	B		2000	1000	500	<=300			
1.85	C			2000	1000	500	<=300		
2.2	D				2000	1000	500	<=300	
2.55	E	a				2000	1000	500	<=300
			b	c	d	e	f	g	h

Luminance Table

Gama (deg)	45	50	55	60	65	70	75	80	85
C0	15227	12982	10508	7920	5464	4174	3496	2696	1255
C90	12761	10376	7841	5381	3627	2904	2034	807	0

Luminance Limiting Curve

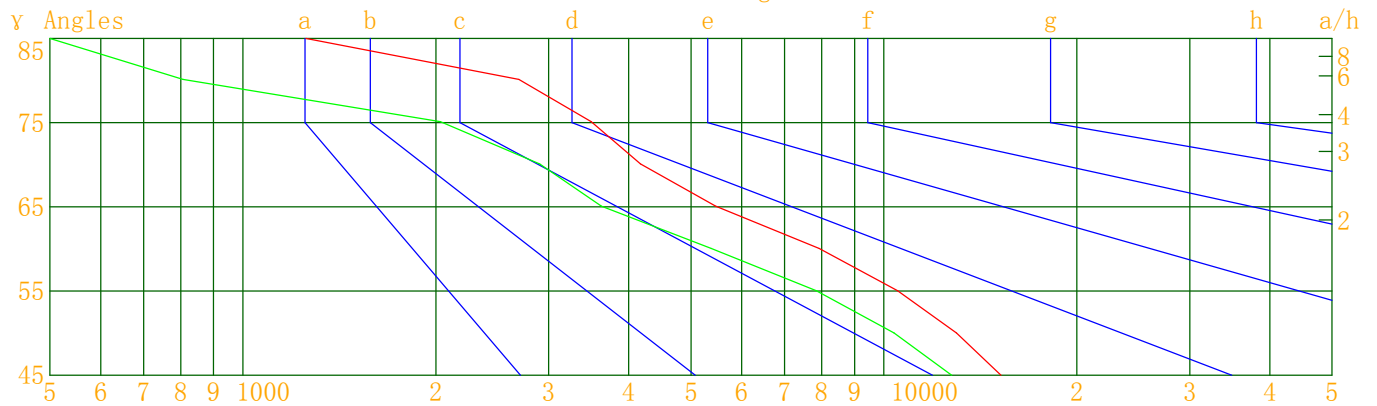

Luminous Size: Length(m)=0.130 Width(m)=0.130 Height(m)=0.068 Area(m²)=0.025740
 Luminous Type: Without Luminous Side
 Luminous Curves: C0-C180 Color: — C90-C270 Color: —

IES Indoor Report

Photometric Filename:LGDLR15WCCT-WH 6K.IES

Indoor Budgetary Estimate Table

Lum. Name: LGDLR15WCCT-WH	Lum. Catalog: LED DOWNLIGHT	Test ID:
Lamp Name: 6000K	Lamp Catalog: SMD2835	Test Lab:
Manufacture:	Test Machine:GON-2000	Test Date: 2019/08/10

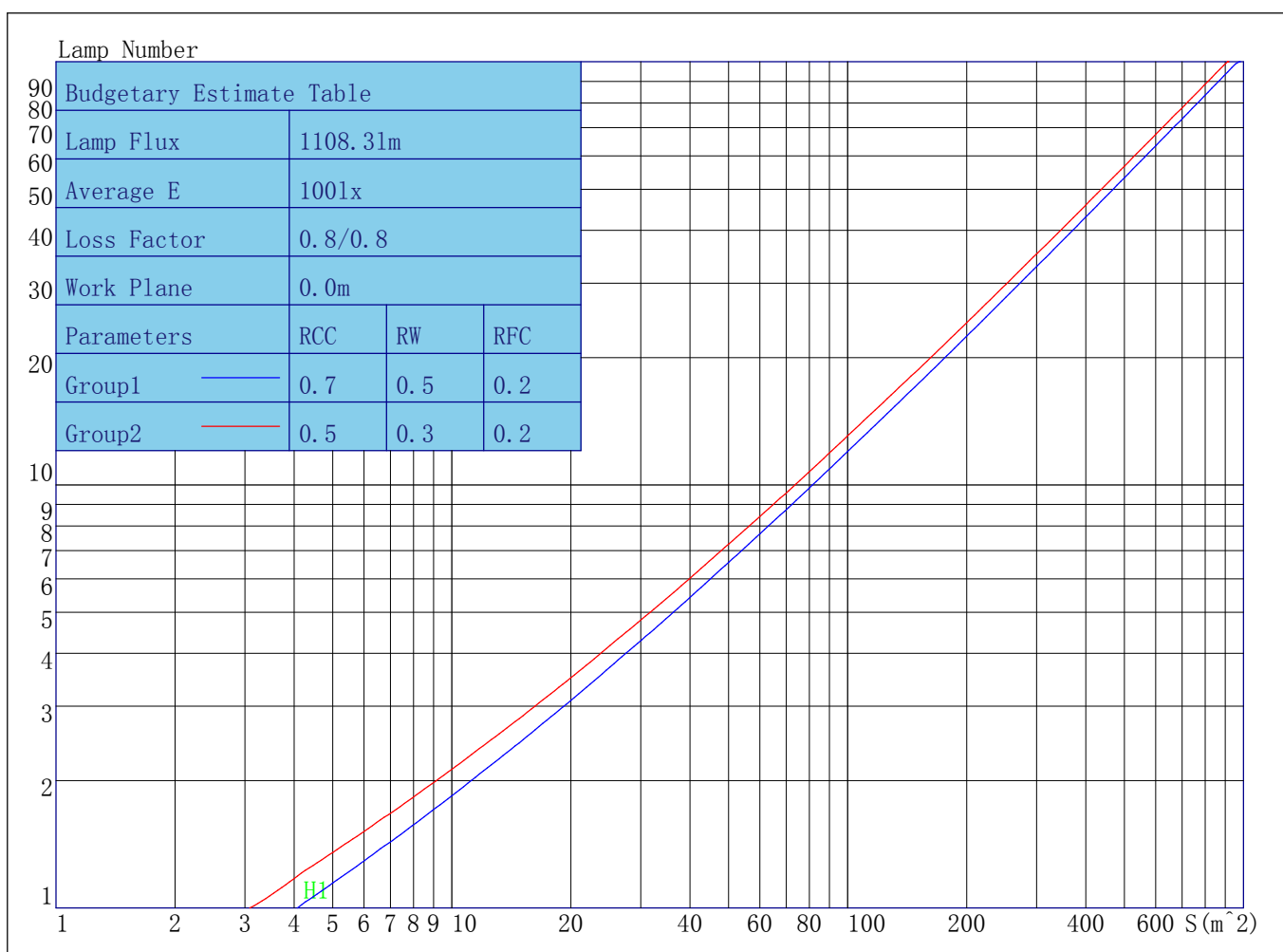

Parameters1: Rhocc = 0.7 Rhow = 0.5 Rhofc = 0.2 LLF = 0.8

Parameters2: Rhocc = 0.5 Rhow = 0.3 Rhofc = 0.2 LLF = 0.8

Average Illuminance(lx): 100 Cavity Height: H1(m) = 2

IES Indoor Report

Photometric Filename:LGDLR15WCCT-WH 6K.IES

Indoor Coefficient of Utilization Table

Lum. Name: LGDLR15WCCT-WH	Lum. Catalog: LED DOWNLIGHT	Test ID:
Lamp Name: 6000K	Lamp Catalog: SMD2835	Test Lab:
Manufacture:	Test Machine:GON-2000	Test Date: 2019/08/10

Coefficients of Utilization - Zonal Cavity Method																		
Coef.	Effective Floor Cavity Reflectance RFC=0.20																	
RhoCC (%)	80				70				50			30			10			0
RhoW (%)	70	50	30	10	70	50	30	10	50	30	10	50	30	10	50	30	10	0
RCR	Coefficient of Utilization(%)																	
0	119	119	119	119	116	116	116	116	111	111	111	106	106	106	102	102	102	100
1	111	107	104	101	109	105	102	99	101	99	96	97	95	93	94	92	91	89
2	103	96	91	86	101	95	90	85	91	87	83	88	85	81	85	82	80	78
3	95	87	80	75	93	85	79	74	82	77	73	80	75	71	77	73	70	68
4	89	78	71	65	86	77	70	65	75	69	64	72	67	63	70	66	62	60
5	82	71	63	58	80	70	63	57	68	62	57	66	61	56	64	59	56	54
6	77	65	57	51	75	64	56	51	62	56	51	61	55	50	59	54	50	48
7	71	59	52	46	70	59	51	46	57	51	46	56	50	45	55	49	45	43
8	67	55	47	42	65	54	47	42	53	46	41	52	46	41	50	45	41	39
9	63	51	43	38	61	50	43	38	49	42	38	48	42	38	47	41	37	36
10	59	47	40	35	58	46	39	35	45	39	35	45	39	34	44	38	34	33

IES Indoor Report

Photometric Filename:LGDLR15WCCT-WH 6K.IES

Unified Glare Rating Table

Lum. Name: LGDLR15WCCT-WH	Lum. Catalog: LED DOWNLIGHT	Test ID:
Lamp Name: 6000K	Lamp Catalog: SMD2835	Test Lab:
Manufacture:	Test Machine:GON-2000	Test Date: 2019/08/10

Unified Glare Rating Table

Ceiling RCC	0.70	0.70	0.50	0.50	0.30	0.70	0.70	0.50	0.50	0.30
Wall RW	0.50	0.30	0.50	0.30	0.30	0.50	0.30	0.50	0.30	0.30
Floor RFC	0.20	0.20	0.20	0.20	0.20	0.20	0.20	0.20	0.20	0.20
Room Size	Vewed crosswise					Vewed endwise				
X=2H Y=2H	31.8	34.7	32.5	35.3	35.9	30.3	33.2	31.0	33.8	34.4
Y=3H	32.9	35.8	33.7	36.4	37.0	31.1	34.0	31.8	34.6	35.2
Y=4H	34.1	36.6	34.9	37.2	37.7	32.1	34.5	32.8	35.1	35.7
Y=6H	34.5	36.9	35.2	37.5	38.0	32.2	34.5	32.9	35.2	35.7
Y=8H	34.5	36.9	35.3	37.5	38.1	32.1	34.5	32.8	35.1	35.7
Y=12H	34.5	36.9	35.3	37.5	38.1	32.0	34.4	32.8	35.0	35.6
X=4H Y=2H	32.2	34.7	33.0	35.3	35.8	30.9	33.3	31.6	34.0	34.5
Y=3H	33.5	35.9	34.2	36.6	37.1	31.8	34.3	32.6	34.9	35.5
Y=4H	33.0	34.2	33.9	35.1	35.9	31.1	32.4	32.1	33.2	34.0
Y=6H	33.5	34.7	34.5	35.5	36.3	31.3	32.5	32.3	33.3	34.1
Y=8H	33.7	34.8	34.6	35.6	36.4	31.3	32.5	32.3	33.3	34.1
Y=12H	32.8	33.7	33.8	34.7	35.5	30.4	31.3	31.4	32.3	33.1
X=8H Y=4H	32.9	34.1	33.9	34.9	35.7	31.1	32.3	32.0	33.1	33.9
Y=6H	32.6	33.4	33.7	34.4	35.3	30.5	31.3	31.5	32.3	33.1
Y=8H	32.3	33.0	33.4	34.0	34.9	30.0	30.7	31.2	31.7	32.6
Y=12H	32.4	33.0	33.5	34.0	34.9	30.0	30.6	31.1	31.7	32.6
X=12H Y=4H	32.0	32.9	33.0	33.8	34.7	30.2	31.1	31.2	32.0	32.9
Y=6H	32.1	32.7	33.2	33.8	34.7	30.0	30.6	31.1	31.7	32.6
Y=8H	32.3	32.9	33.4	33.9	34.8	30.0	30.6	31.1	31.7	32.6
Variations with the objver position at spacings										
S=1.0H	4.7/-3.1					5.0/-2.5				
S=1.5H	-2.2/-27.6					-0.7/-25.6				
S=2.0H	-2.2/-27.6					-0.7/-25.6				

IES Indoor Report

Photometric Filename:LGDLR15WCCT-WH 6K.IES

Candela Tabulation

V/H	C0.0	C90.0	C180.0	C270.0
Y 0.0	585.13	585.13	585.13	585.13
Y 5.0	582.98	578.17	581.72	585.25
Y 10.0	574.94	564.42	571.05	579.53
Y 15.0	559.64	543.48	553.36	567.65
Y 20.0	535.43	511.84	526.87	547.92
Y 25.0	500.40	467.85	488.72	517.18
Y 30.0	453.65	414.90	439.11	475.36
Y 35.0	398.96	356.02	382.36	423.32
Y 40.0	339.23	294.53	321.53	364.86
Y 45.0	277.14	232.26	259.15	303.76
Y 50.0	214.79	171.68	197.35	241.66
Y 55.0	155.14	115.77	138.78	180.74
Y 60.0	101.93	69.26	87.75	124.29
Y 65.0	59.44	39.45	49.56	76.54
Y 70.0	36.74	25.57	31.50	43.94
Y 75.0	23.29	13.55	18.84	29.15
Y 80.0	12.05	3.61	8.38	16.76
Y 85.0	2.82	0.00	0.03	6.25
Y 90.0	0.00	0.00	0.00	0.00
Y 95.0	0.00	0.00	0.00	0.00
Y 100.0	0.00	0.00	0.00	0.00
Y 105.0	0.00	0.00	0.00	0.00
Y 110.0	0.00	0.00	0.00	0.00
Y 115.0	0.00	0.00	0.00	0.00
Y 120.0	0.00	0.00	0.00	0.00
Y 125.0	0.00	0.00	0.00	0.00
Y 130.0	0.00	0.00	0.00	0.00
Y 135.0	0.00	0.00	0.00	0.00
Y 140.0	0.00	0.00	0.00	0.00
Y 145.0	0.00	0.00	0.00	0.00
Y 150.0	0.00	0.00	0.00	0.00
Y 155.0	0.06	0.00	0.06	0.00
Y 160.0	0.42	0.39	0.37	0.19
Y 165.0	0.74	0.65	0.79	0.54
Y 170.0	1.01	0.97	1.03	0.95
Y 175.0	1.19	1.19	1.31	1.25
Y 180.0	1.37	1.37	1.37	1.37
