

Indoor Luminaire Photometric Data

Description Information

Lum. Name: LGDL12WCCT-WH-4K	Lum. Catalog: LED DOWNLIGHT	Test ID:
Lamp Name: 4000K	Lamp Catalog: SMD2835	Test Date: 2019/08/30
Manufacture:	ShldAngle(°):	Test Machine:GON-2000
Test Lab:	Frequency(Hz):	Lamp CCT(K): Ra:
Lum. Size (W*L*H):0.105m*0.105m*0.060m	Lum. Area(m2):0.017	Lum. W(kg): 2.000
Test System: C, γ	Test Step: C=90.0 γ=5.0	Temp.(°C): 25
		Humidity(%):

Character Parameter

Lamp Speciality Parameter		Luminaire Speciality Parameter	
Rated Flux(lm): 873.050	Luminaire Flux: 873.049lm	Field Angle(10%Imax): 126.3	
Rated Power(W):	Luminaire Efficiency: 100.00%	Down Lumens&Percent: 870.722lm 99.73%	
Rated Voltage(V):	Luminaire EER(lm/W): 74.811	Up Lumens&Percent: 2.328lm 0.27%	
Tested Power(W): 11.670	Max. Cand. (cd): 494.032	S/MH: C0_a180=1.119 C90_270=1.120	
Lamps' Inside: 1	Max Cand@Ang. (°): C=270.0 γ=5.0	CIE Type: Semi-Direct	
Tested Electric:U=229.0V, I=0.052A, PF=0.000	Beam Angle(50%Imax): 81.4	ErP Φ use(90°): 631.899lm	
Lamp Size(W*L*H):0.105m*0.105m*0.060m	Left=-37.6 Right=43.8	IRF: 141.383%	

Lighting Distribution Diagram

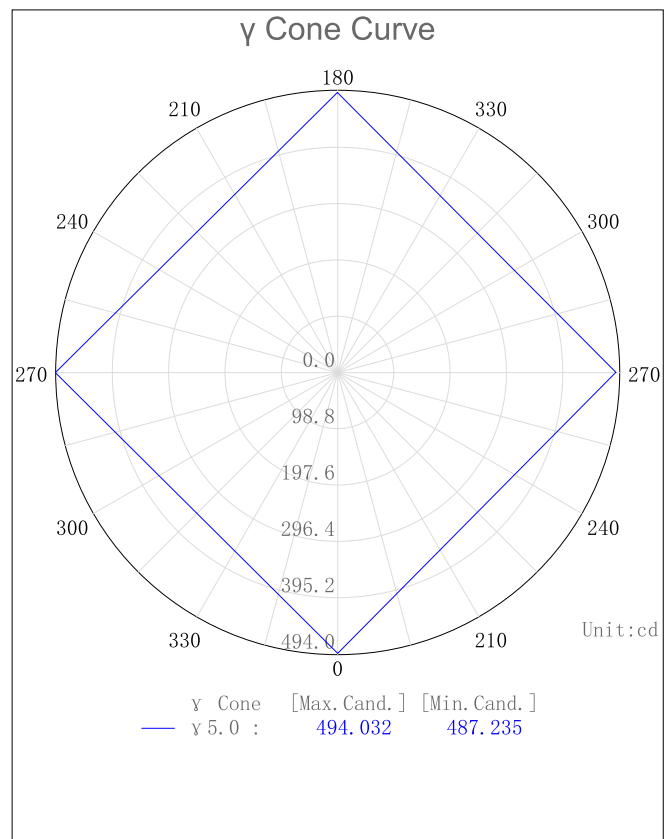
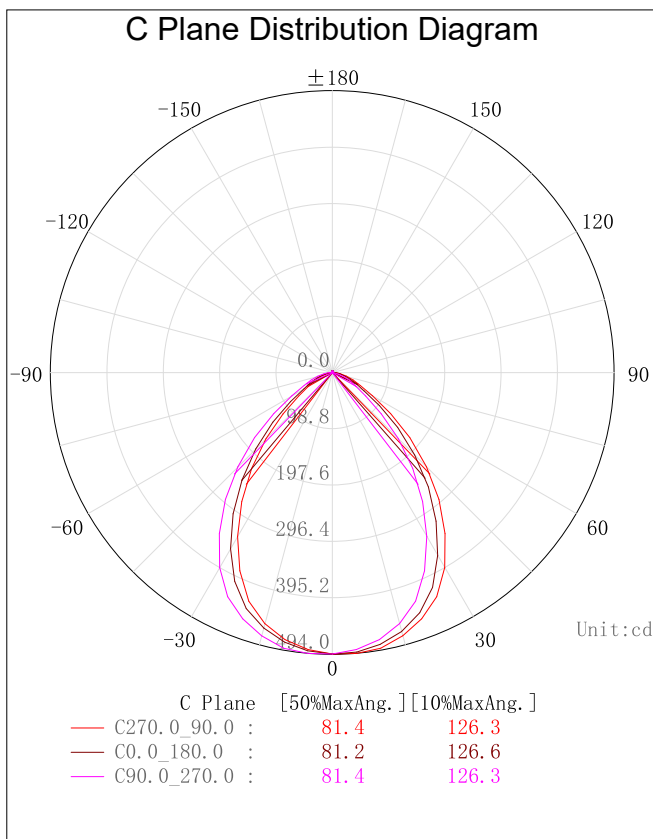

3D Light Intensity Distribution Modal

Lum. Name: LGDL12WCCT-WH-4K	Lum. Catalog: LED DOWNLIGHT	Test ID:
Lamp Name: 4000K	Lamp Catalog: SMD2835	Test Lab:
Manufacture:	Test Machine:GON-2000	Test Date: 2019/08/30

3D Light Intensity Distribution Modal

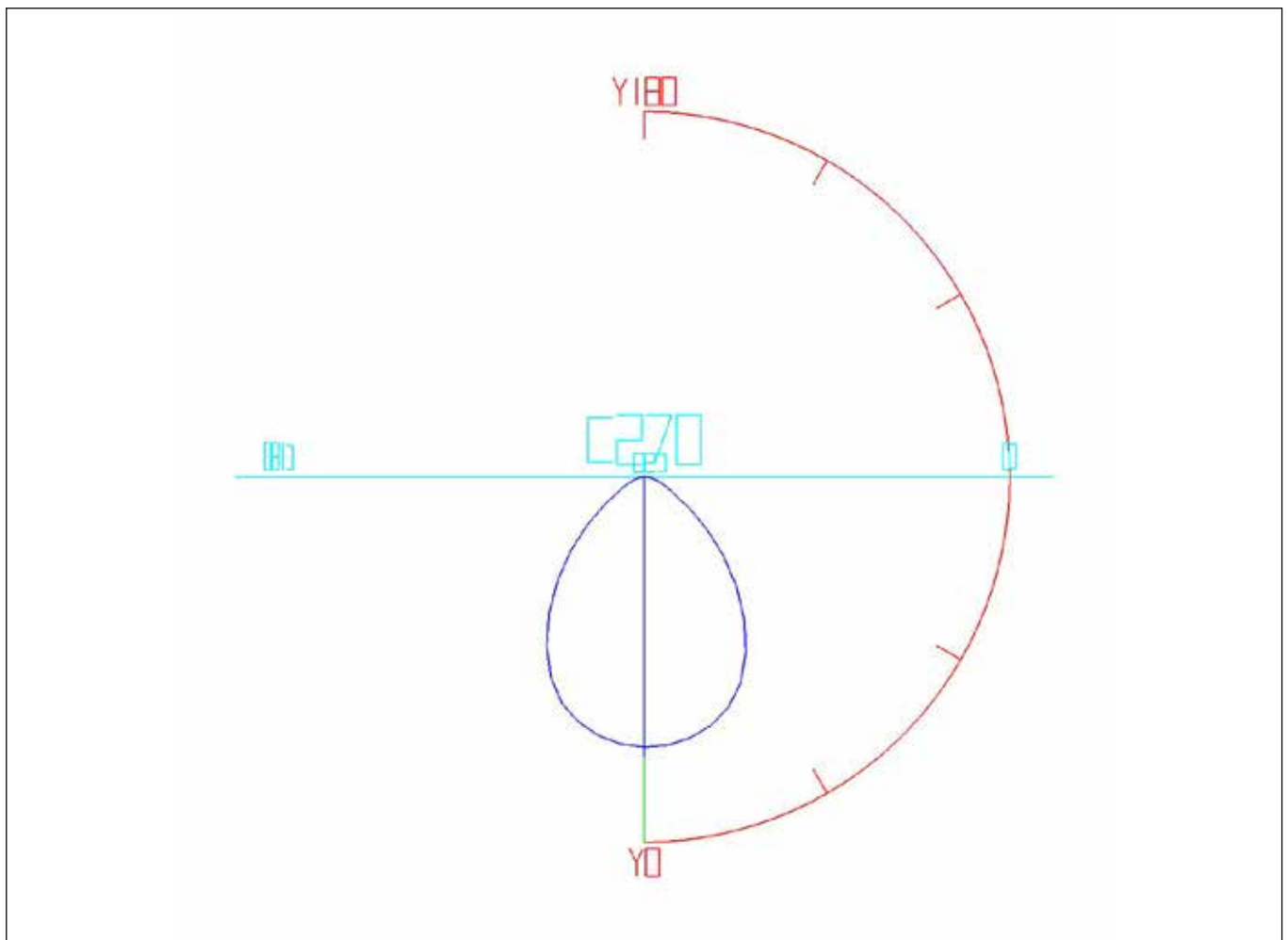

Curves: 3D Model — Fixture — Vert. HUD — Hori. HUD —
 View Angles: Orient:0 Tilt:0 Roll:0 Spin:0

Zonal Flux Tabulation

Zone (y)	Zone Flux (lm)	Sums Flux (lm)	Zone%Lamp	Sums%Lamp
0.0-5.0	11.76	11.76	1.35	1.35
5.0-10.0	34.80	46.57	3.99	5.33
10.0-15.0	56.28	102.85	6.45	11.78
15.0-20.0	74.99	177.84	8.59	20.37
20.0-25.0	89.38	267.22	10.24	30.61
25.0-30.0	97.70	364.92	11.19	41.80
30.0-35.0	99.19	464.11	11.36	53.16
35.0-40.0	94.23	558.34	10.79	63.95
40.0-45.0	83.71	642.05	9.59	73.54
45.0-50.0	69.02	711.07	7.91	81.45
50.0-55.0	52.32	763.39	5.99	87.44
55.0-60.0	36.86	800.25	4.22	91.66
60.0-65.0	25.98	826.23	2.98	94.64
65.0-70.0	18.94	845.17	2.17	96.81
70.0-75.0	13.06	858.23	1.50	98.30
75.0-80.0	7.85	866.08	0.90	99.20
80.0-85.0	3.66	869.74	0.42	99.62
85.0-90.0	0.98	870.72	0.11	99.73
90.0-95.0	0.05	870.77	0.01	99.74
95.0-100.0	0.00	870.77	0.00	99.74
100.0-105.0	0.00	870.77	0.00	99.74
105.0-110.0	0.00	870.77	0.00	99.74
110.0-115.0	0.00	870.77	0.00	99.74
115.0-120.0	0.00	870.77	0.00	99.74
120.0-125.0	0.00	870.77	0.00	99.74
125.0-130.0	0.00	870.78	0.00	99.74
130.0-135.0	0.06	870.83	0.01	99.75
135.0-140.0	0.16	871.00	0.02	99.76
140.0-145.0	0.26	871.25	0.03	99.79
145.0-150.0	0.31	871.57	0.04	99.83
150.0-155.0	0.34	871.91	0.04	99.87
155.0-160.0	0.34	872.25	0.04	99.91
160.0-165.0	0.31	872.56	0.04	99.94
165.0-170.0	0.26	872.82	0.03	99.97
170.0-175.0	0.17	872.99	0.02	99.99
175.0-180.0	0.06	873.05	0.01	100.00

Rectangle ISO Lighting Intensity Diagram

Lum. Name: LGDL12WCCT-WH-4K	Lum. Catalog: LED DOWNLIGHT	Test ID:
Lamp Name: 4000K	Lamp Catalog: SMD2835	Test Lab:
Manufacture:	Test Machine:GON-2000	Test Date: 2019/08/30

ISO Lighting Intensity Curve

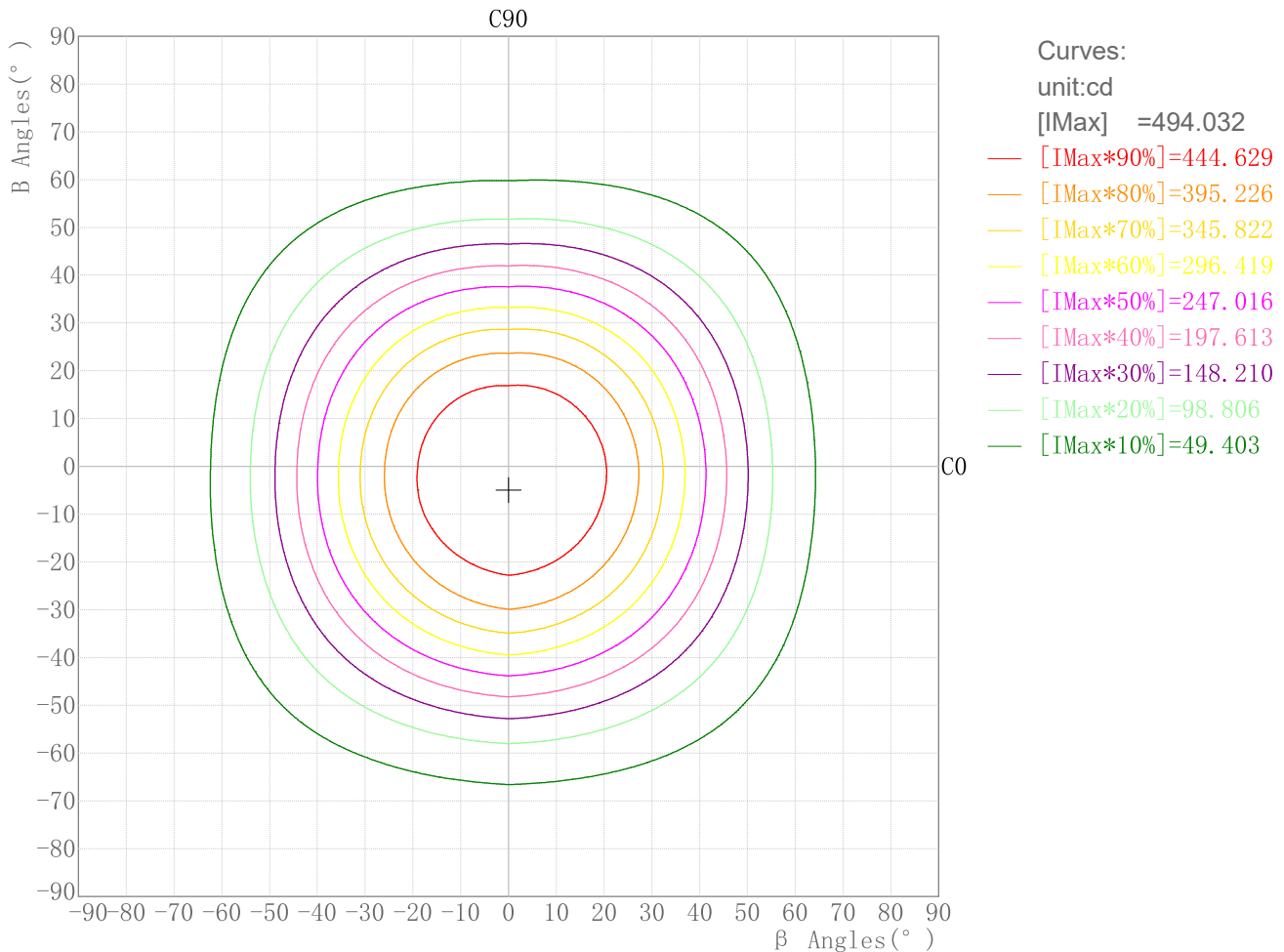

Maximum Light Intensity(cd): 494.03

Maximum Cand.@Angle: H=-0.0°,V=-5.0°

Plane ISO-Illuminance Diagram

Lum. Name: LGDL12WCCT-WH-4K	Lum. Catalog: LED DOWNLIGHT	Test ID:
Lamp Name: 4000K	Lamp Catalog: SMD2835	Test Lab:
Manufacture:	Test Machine:GON-2000	Test Date: 2019/08/30

Plane ISO-Illuminance Curve

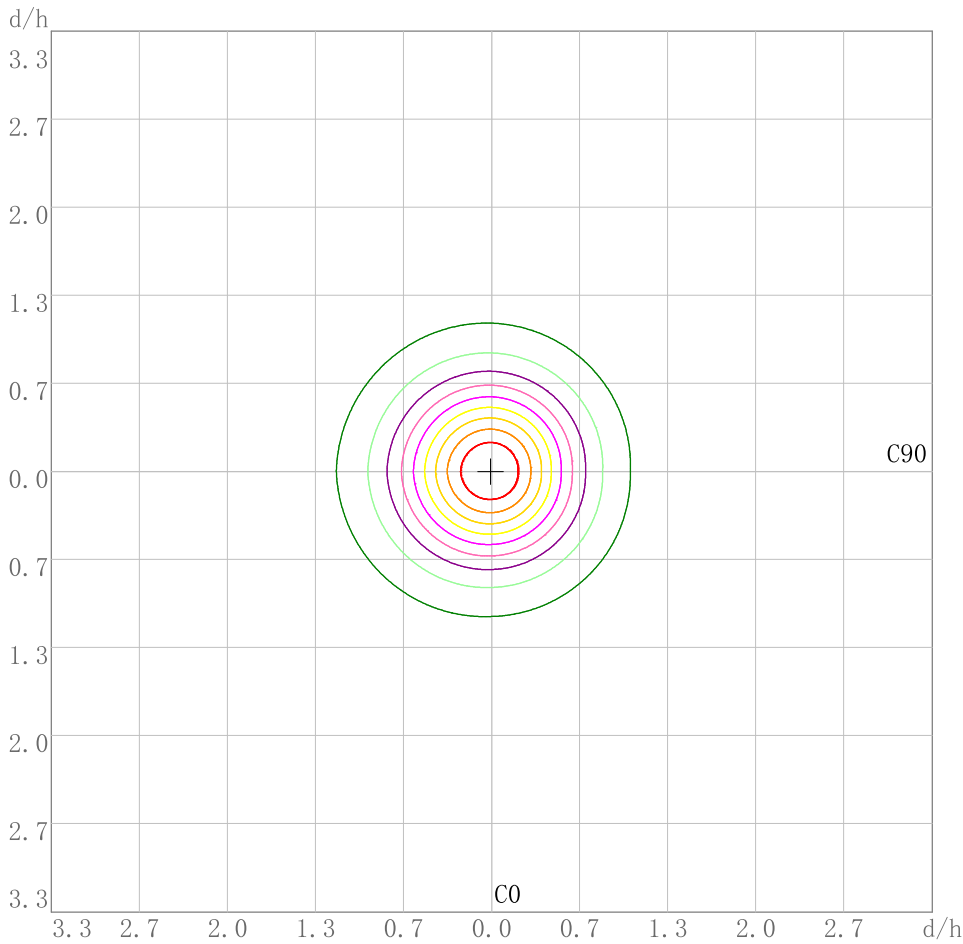

- Curves:**
 unit:lx
 [EMax] =54.825
- [EMax*90%]=49.342
 - [EMax*80%]=43.860
 - [EMax*70%]=38.377
 - [EMax*60%]=32.895
 - [EMax*50%]=27.412
 - [EMax*40%]=21.930
 - [EMax*30%]=16.447
 - [EMax*20%]=10.965
 - [EMax*10%]=5.482

Working Plane Luminaire Mounting Height(m): 3.00
 Working Plane Maximum Illuminance(lx): 54.82
 Working Plane Maximum Illuminance Position(d/h):H-0.0 V-0.0

3D Plane ISO Illuminance Diagram

Lum. Name: LGDL12WCCT-WH-4K	Lum. Catalog: LED DOWNLIGHT	Test ID:
Lamp Name: 4000K	Lamp Catalog: SMD2835	Test Lab:
Manufacture:	Test Machine:GON-2000	Test Date: 2019/08/30

3D Plane Illuminance Modal

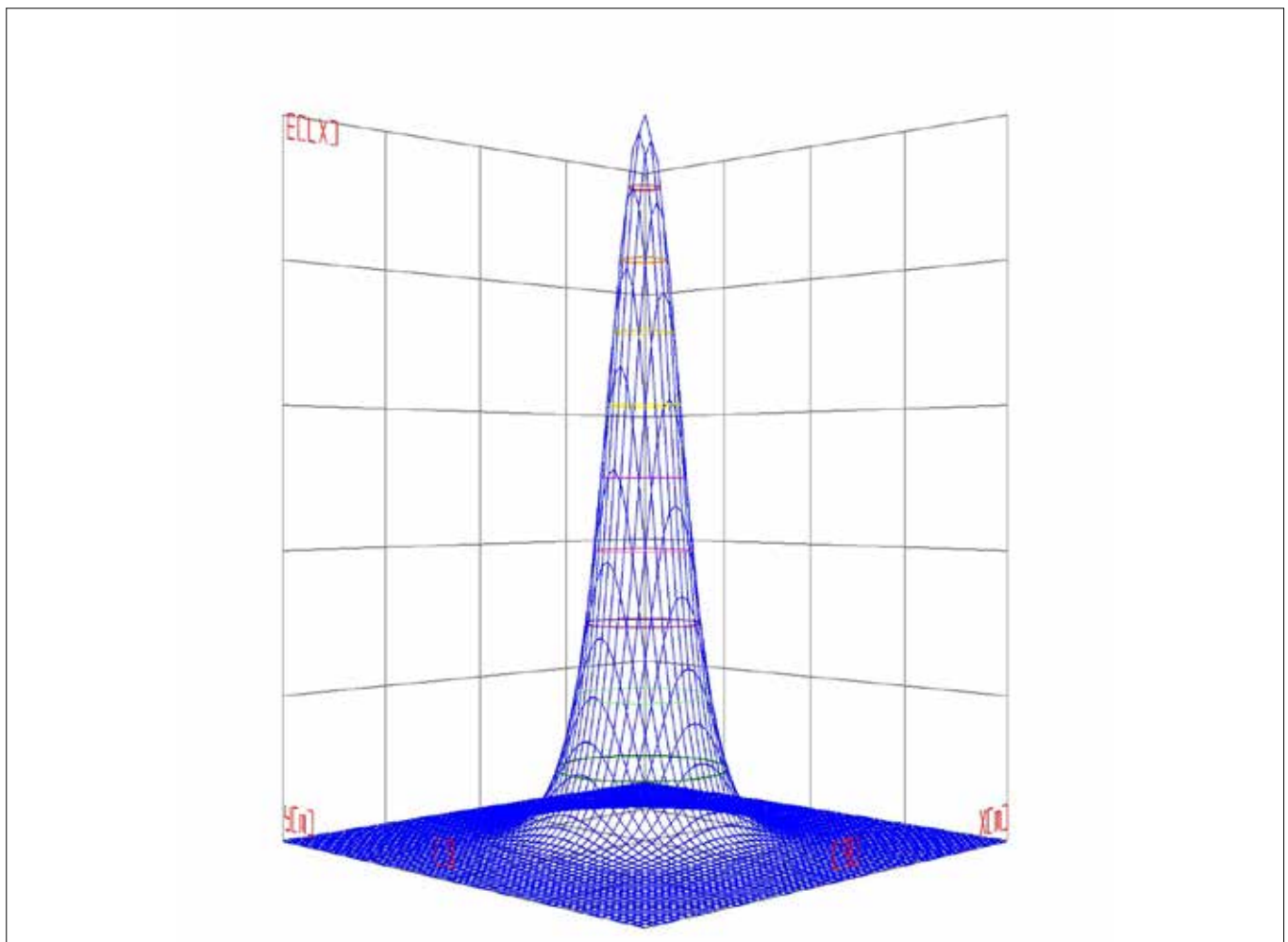

Curves: 3D Model — 90% — 80% — 70% — 60% — 50% — 40% — 30% — 20% — 10% —
View Angles(deg): 0 Height(m): 3.0 Distance(m): 10.0

Space ISO Illuminance Diagram

Lum. Name: LGDL12WCCT-WH-4K	Lum. Catalog: LED DOWNLIGHT	Test ID:
Lamp Name: 4000K	Lamp Catalog: SMD2835	Test Lab:
Manufacture:	Test Machine:GON-2000	Test Date: 2019/08/30

Space ISO Illuminance Curve

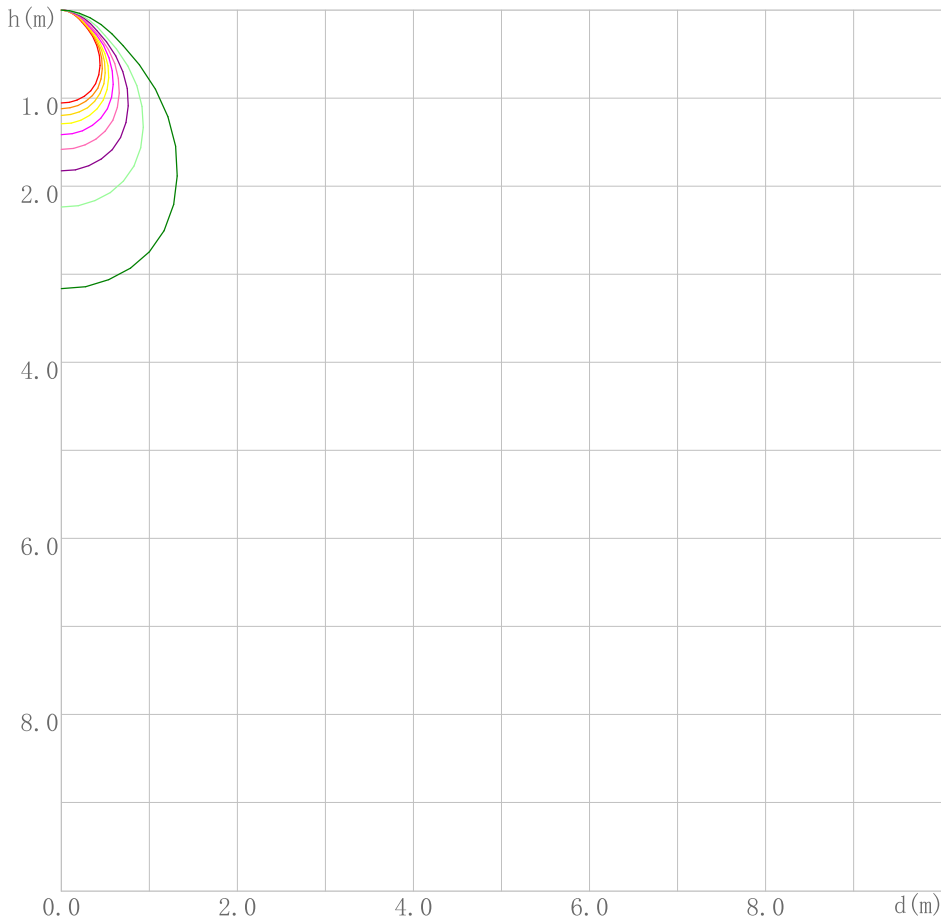

- Curves:
unit:lx
- [EMax] =493.416
 - [EMax*90%]=444.074
 - [EMax*80%]=394.733
 - [EMax*70%]=345.391
 - [EMax*60%]=296.050
 - [EMax*50%]=246.708
 - [EMax*40%]=197.366
 - [EMax*30%]=148.025
 - [EMax*20%]=98.683
 - [EMax*10%]=49.342

Space Plane Maximum Illuminance and @Angle:493.42,0.0deg
Plane Maximum Lighting Intensity and @Angle:493.416cd,0deg

Illuminance-Distance Diagram

Lum. Name: LGDL12WCCT-WH-4K	Lum. Catalog: LED DOWNLIGHT	Test ID:
Lamp Name: 4000K	Lamp Catalog: SMD2835	Test Lab:
Manufacture:	Test Machine:GON-2000	Test Date: 2019/08/30

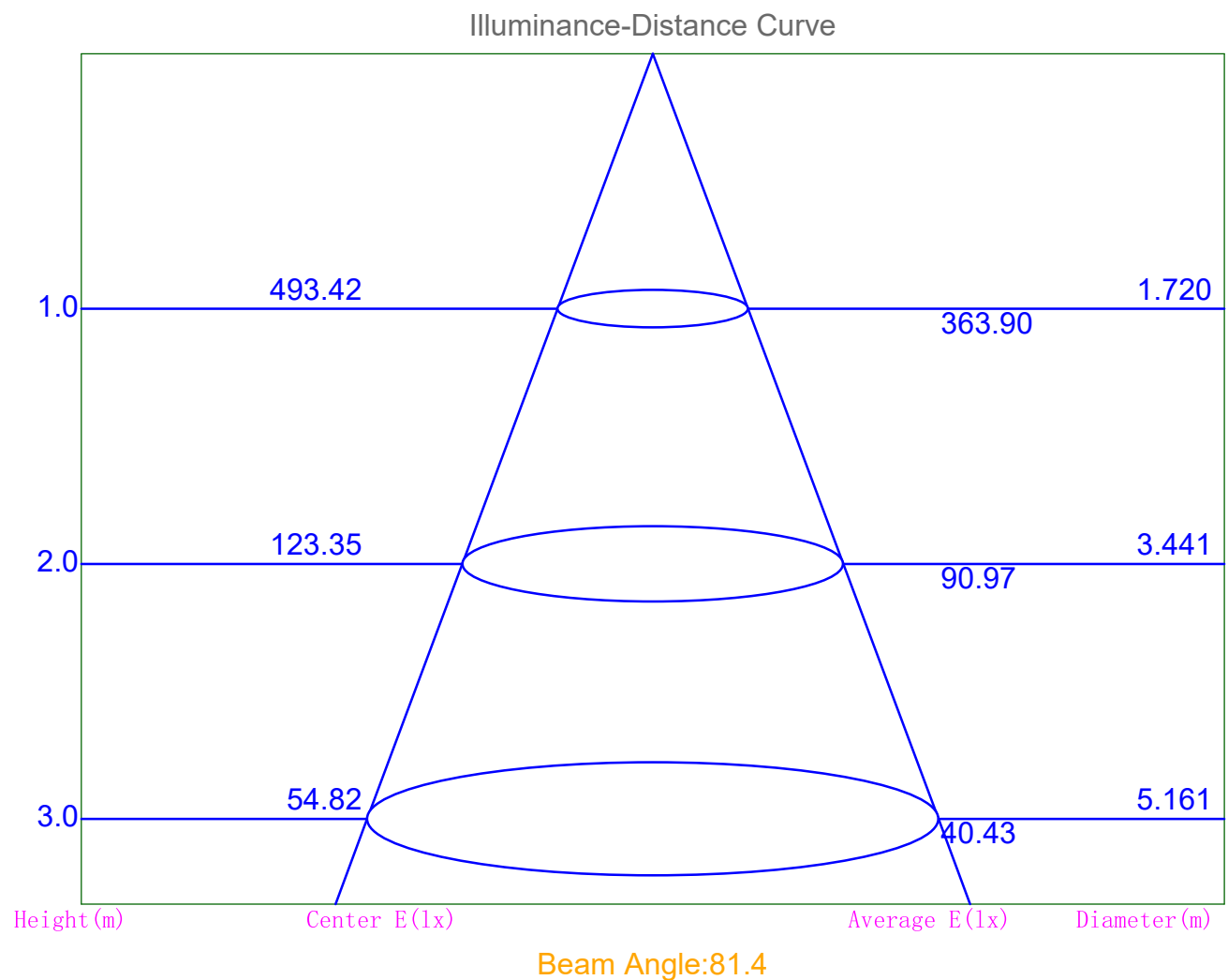

Indoor Luminance Limiting Curves

Lum. Name: LGDL12WCCT-WH-4K	Lum. Catalog: LED DOWNLIGHT	Test ID:
Lamp Name: 4000K	Lamp Catalog: SMD2835	Test Lab:
Manufacture:	Test Machine:GON-2000	Test Date: 2019/08/30

Glare Grade Table

GI	Quality	Using Illuminance							
		a	b	c	d	e	f	g	h
1.15	A	2000	1000	500	<=300				
1.5	B		2000	1000	500	<=300			
1.85	C			2000	1000	500	<=300		
2.2	D				2000	1000	500	<=300	
2.55	E	a				2000	1000	500	<=300
			b	c	d	e	f	g	h

Luminance Table

Gama (deg)	45	50	55	60	65	70	75	80	85
C0	16696	13420	10136	7447	6377	5630	4887	4197	3374
C90	13351	10121	7205	5570	4700	3734	2646	1210	0

Luminance Limiting Curve

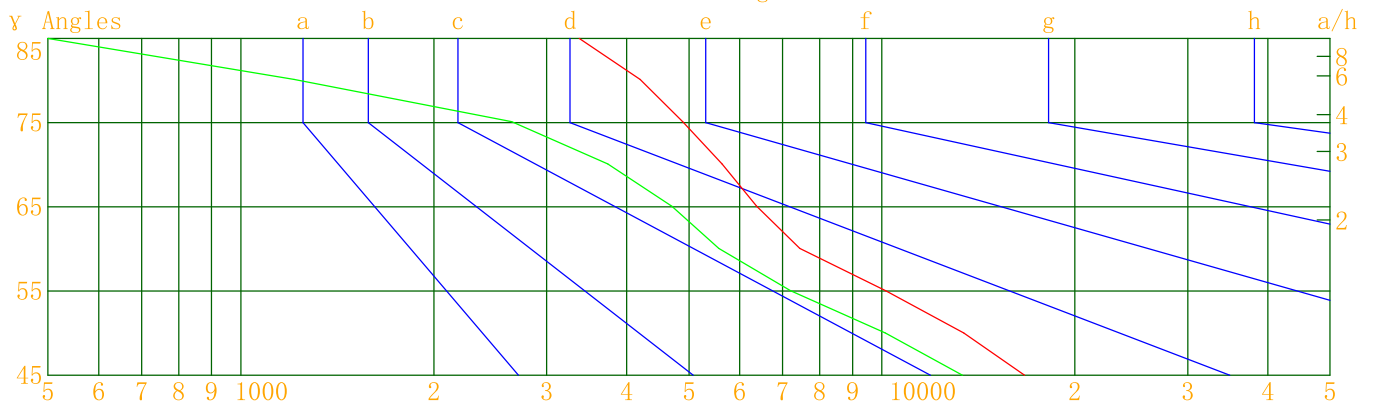

Luminous Size: Length(m)=0.105 Width(m)=0.105 Height(m)=0.060 Area(m²)=0.017325
 Luminous Type: Without Luminous Side
 Luminous Curves: C0-C180 Color: — C90-C270 Color: —

Indoor Budgetary Estimate Table

Lum. Name: LGDL12WCCT-WH-4K	Lum. Catalog: LED DOWNLIGHT	Test ID:
Lamp Name: 4000K	Lamp Catalog: SMD2835	Test Lab:
Manufacture:	Test Machine:GON-2000	Test Date: 2019/08/30

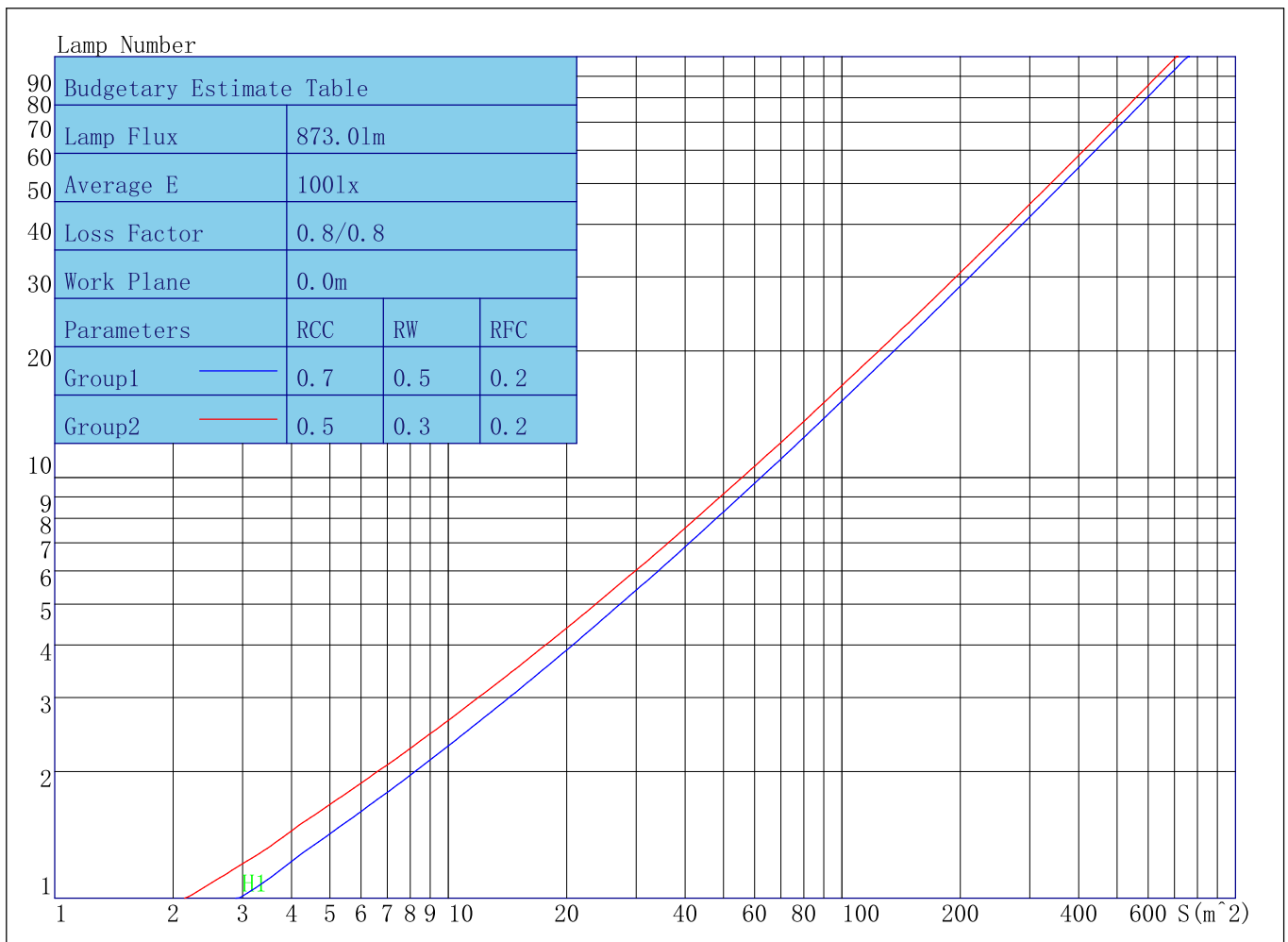

Parameters1: Rhocc = 0.7 Rhow = 0.5 Rhofc = 0.2 LLF = 0.8
 Parameters2: Rhocc = 0.5 Rhow = 0.3 Rhofc = 0.2 LLF = 0.8
 Average Illuminance(lx): 100 Cavity Height: H1(m) = 2

Indoor Coefficient of Utilization Table

Lum. Name: LGDL12WCCT-WH-4K	Lum. Catalog: LED DOWNLIGHT	Test ID:
Lamp Name: 4000K	Lamp Catalog: SMD2835	Test Lab:
Manufacture:	Test Machine:GON-2000	Test Date: 2019/08/30

Coefficients of Utilization - Zonal Cavity Method																		
Coef.	Effective Floor Cavity Reflectance RFC=0.20																	
RhoCC (%)	80				70				50			30			10			0
RhoW (%)	70	50	30	10	70	50	30	10	50	30	10	50	30	10	50	30	10	0
RCR	Coefficient of Utilization(%)																	
0	119	119	119	119	116	116	116	116	111	111	111	106	106	106	102	102	102	100
1	111	107	104	101	109	105	102	99	101	99	96	97	95	93	94	92	91	89
2	103	97	91	87	101	95	90	86	91	87	84	88	85	82	85	82	80	78
3	96	87	80	75	94	86	79	74	83	78	73	80	76	72	78	74	71	69
4	89	79	72	66	87	78	71	66	75	69	65	73	68	64	71	67	63	61
5	83	72	64	59	81	71	64	58	69	63	58	67	61	57	65	60	57	55
6	77	66	58	52	76	65	58	52	63	57	52	62	56	51	60	55	51	49
7	72	60	53	47	71	60	52	47	58	52	47	57	51	47	56	50	46	44
8	68	56	48	43	66	55	48	43	54	47	43	53	47	42	52	46	42	40
9	64	52	44	39	62	51	44	39	50	44	39	49	43	39	48	43	39	37
10	60	48	41	36	59	48	41	36	47	40	36	46	40	36	45	39	36	34

Unified Glare Rating Table

Lum. Name: LGDL12WCCT-WH-4K	Lum. Catalog: LED DOWNLIGHT	Test ID:
Lamp Name: 4000K	Lamp Catalog: SMD2835	Test Lab:
Manufacture:	Test Machine:GON-2000	Test Date: 2019/08/30

Unified Glare Rating Table

Ceiling RCC	0.70	0.70	0.50	0.50	0.30	0.70	0.70	0.50	0.50	0.30	
Wall RW	0.50	0.30	0.50	0.30	0.30	0.50	0.30	0.50	0.30	0.30	
Floor RFC	0.20	0.20	0.20	0.20	0.20	0.20	0.20	0.20	0.20	0.20	
Room Size	Vewed crosswise					Vewed endwise					
X=2H	Y=2H	33.4	36.2	34.1	36.8	37.4	31.9	34.7	32.6	35.3	35.9
	Y=3H	35.0	37.8	35.8	38.5	39.0	33.1	35.9	33.9	36.6	37.2
	Y=4H	36.5	38.8	37.2	39.5	40.1	34.2	36.6	35.0	37.2	37.8
	Y=6H	37.1	39.5	37.9	40.1	40.7	34.4	36.7	35.1	37.4	37.9
	Y=8H	37.4	39.7	38.1	40.3	40.9	34.4	36.7	35.1	37.3	37.9
	Y=12H	37.5	39.8	38.2	40.4	41.0	34.3	36.6	35.0	37.2	37.8
X=4H	Y=2H	33.8	36.2	34.6	36.8	37.4	32.5	34.9	33.3	35.6	36.1
	Y=3H	35.7	38.0	36.4	38.7	39.3	34.0	36.4	34.8	37.0	37.6
	Y=4H	35.4	36.7	36.3	37.5	38.3	33.4	34.7	34.3	35.5	36.3
	Y=6H	36.3	37.5	37.3	38.4	39.2	33.7	35.0	34.7	35.8	36.6
	Y=8H	36.7	37.9	37.6	38.7	39.5	33.8	35.0	34.7	35.8	36.6
	Y=12H	36.0	37.0	37.1	37.9	38.8	32.9	33.8	33.9	34.8	35.7
X=8H	Y=4H	35.3	36.5	36.3	37.4	38.2	33.4	34.6	34.4	35.5	36.3
	Y=6H	35.5	36.3	36.6	37.3	38.2	33.0	33.9	34.1	34.9	35.7
	Y=8H	35.4	36.1	36.6	37.1	38.1	32.7	33.3	33.8	34.4	35.3
	Y=12H	35.7	36.4	36.9	37.4	38.4	32.7	33.3	33.8	34.4	35.3
X=12H	Y=4H	34.4	35.3	35.5	36.3	37.2	32.5	33.4	33.6	34.4	35.3
	Y=6H	35.0	35.6	36.1	36.7	37.6	32.5	33.2	33.7	34.3	35.2
	Y=8H	35.4	36.0	36.5	37.1	38.0	32.6	33.3	33.8	34.3	35.3
Variations with the objver position at spacings											
S=1.0H	4.5/-3.8					4.4/-2.7					
S=1.5H	-3.8/-24.9					-2.3/-22.8					
S=2.0H	-3.8/-24.9					-2.3/-22.8					

IES Indoor Report

Photometric Filename:LGDL12WCCT-WH-4K-2019-08-30.IES (1).IES

Candela Tabulation

V/H	C0.0	C90.0	C180.0	C270.0
Y 0.0	493.42	493.42	493.42	493.42
Y 5.0	491.72	487.23	489.66	494.03
Y 10.0	483.62	475.44	479.75	490.28
Y 15.0	469.75	455.35	463.61	477.46
Y 20.0	447.78	426.58	439.86	459.05
Y 25.0	415.39	383.28	403.76	433.19
Y 30.0	370.09	331.63	356.27	394.47
Y 35.0	317.67	276.56	302.57	345.01
Y 40.0	261.81	219.16	245.92	290.55
Y 45.0	204.54	163.56	189.15	233.67
Y 50.0	149.45	112.71	135.79	177.52
Y 55.0	100.73	71.60	89.45	125.21
Y 60.0	64.51	48.25	56.70	81.43
Y 65.0	46.69	34.41	41.13	54.29
Y 70.0	33.36	22.12	28.30	38.90
Y 75.0	21.92	11.87	17.75	25.68
Y 80.0	12.63	3.64	9.03	14.89
Y 85.0	5.09	0.00	2.14	6.43
Y 90.0	0.00	0.00	0.00	0.71
Y 95.0	0.00	0.00	0.00	0.00
Y 100.0	0.00	0.00	0.00	0.00
Y 105.0	0.00	0.00	0.00	0.00
Y 110.0	0.00	0.00	0.00	0.00
Y 115.0	0.00	0.00	0.00	0.00
Y 120.0	0.00	0.00	0.00	0.00
Y 125.0	0.00	0.00	0.00	0.00
Y 130.0	0.09	0.00	0.00	0.00
Y 135.0	0.39	0.22	0.20	0.21
Y 140.0	0.79	0.60	0.61	0.53
Y 145.0	1.03	0.87	0.88	0.83
Y 150.0	1.37	1.20	1.21	1.13
Y 155.0	1.59	1.45	1.49	1.35
Y 160.0	1.89	1.73	1.80	1.68
Y 165.0	2.11	2.00	2.10	1.91
Y 170.0	2.40	2.22	2.32	2.27
Y 175.0	2.56	2.41	2.50	2.51
Y 180.0	2.58	2.58	2.58	2.58