

IES Indoor Report

Photometric Filename:ICDLT13WCCT-WH-4K.IES

Indoor Luminaire Photometric Data

Description Information

Lum. Name: ICDLT13WCCT-WH	Lum. Catalog: LED DOWNLIGHT	Test ID:
Lamp Name: 4000K	Lamp Catalog: SMD2835	Test Date: 2020/03/16
Manufacture:	ShldAngle(°):	Test Machine:GON-2000
Test Lab:	Frequency(Hz):	Lamp CCT(K): Ra:
Lum. Size(W*L*H):0.115m*0.115m*0.053m	Lum. Area(m2):0.019	Lum. W(kg): 0.000
Test System: C, γ	Test Step: C=90.0 γ=5.0	Temp.(°C): 25
		Humidity(%):

Character Parameter

Lamp Speciality Parameter		Luminaire Speciality Parameter	
Rated Flux(lm): 1004.540	Luminaire Flux: 1004.544lm	Field Angle(10%Imax): 144.0	
Rated Power(W):	Luminaire Efficiency: 100.00%	Down Lumens&Percent: 984.667lm 98.02%	
Rated Voltage(V):	Luminaire EER(lm/W): 82.407	Up Lumens&Percent: 19.878lm 1.98%	
Tested Power(W): 12.190	Max. Cand. (cd): 468.000	S/MH: C0_a180=1.142 C90_270=1.125	
Lamps' Inside: 1	Max Cand@Ang.(°): C=0.0 γ=5.0	CIE Type: Semi-Direct	
Tested Electric:U=240.4V, I=0.052A, PF=0.000	Beam Angle(50%Imax): 90.4	ErP Φuse(120°): 853.826lm	
Lamp Size(W*L*H):0.115m*0.115m*0.053m	Left=-43.9 Right=46.4	IRF: 128.399%	

Lighting Distribution Diagram

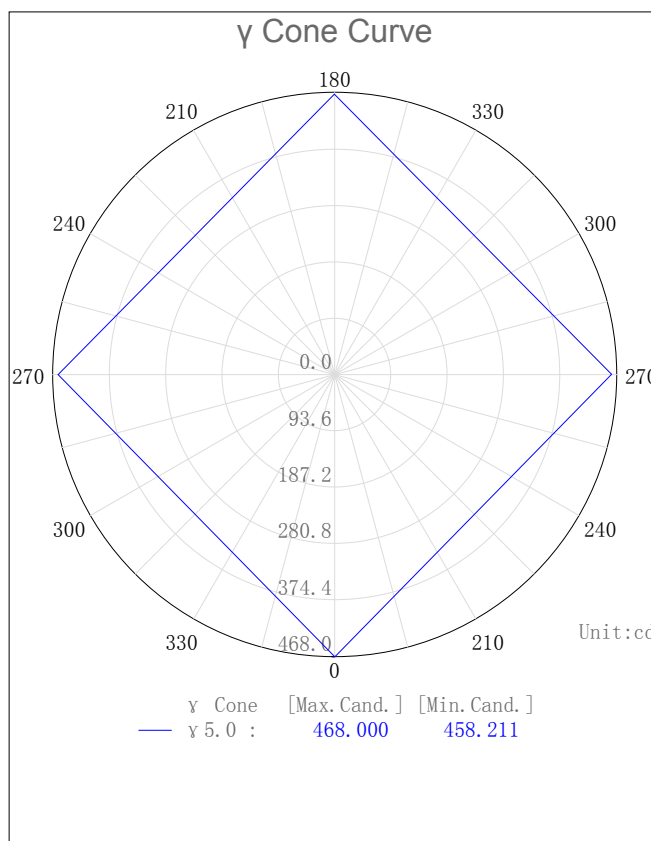
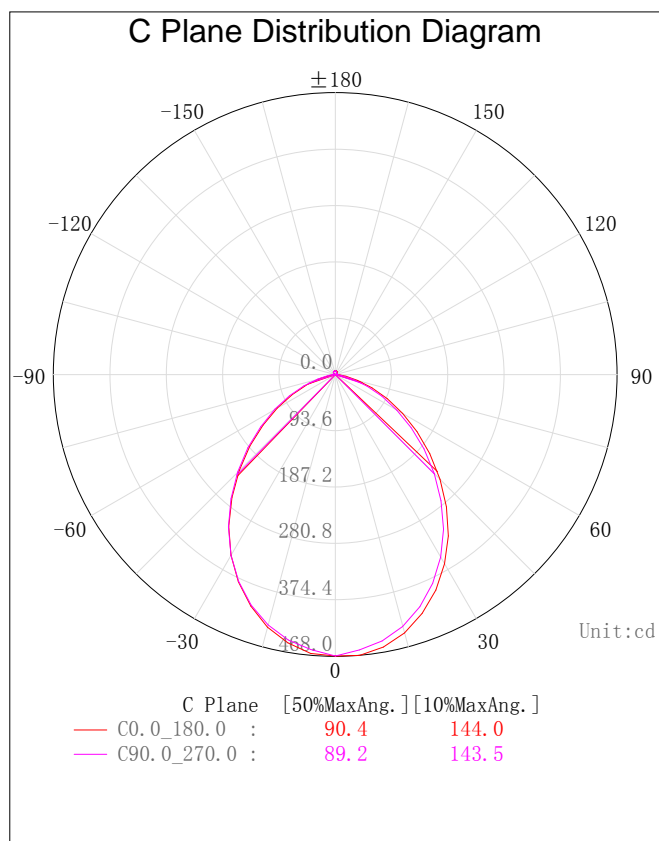

IES Indoor Report

Photometric Filename:ICDLT13WCCT-WH-4K.IES

3D Light Intensity Distribution Modal

Lum. Name: ICDLT13WCCT-WH	Lum. Catalog: LED DOWNLIGHT	Test ID:
Lamp Name: 4000K	Lamp Catalog: SMD2835	Test Lab:
Manufacture:	Test Machine:GON-2000	Test Date: 2020/03/16

3D Light Intensity Distribution Modal

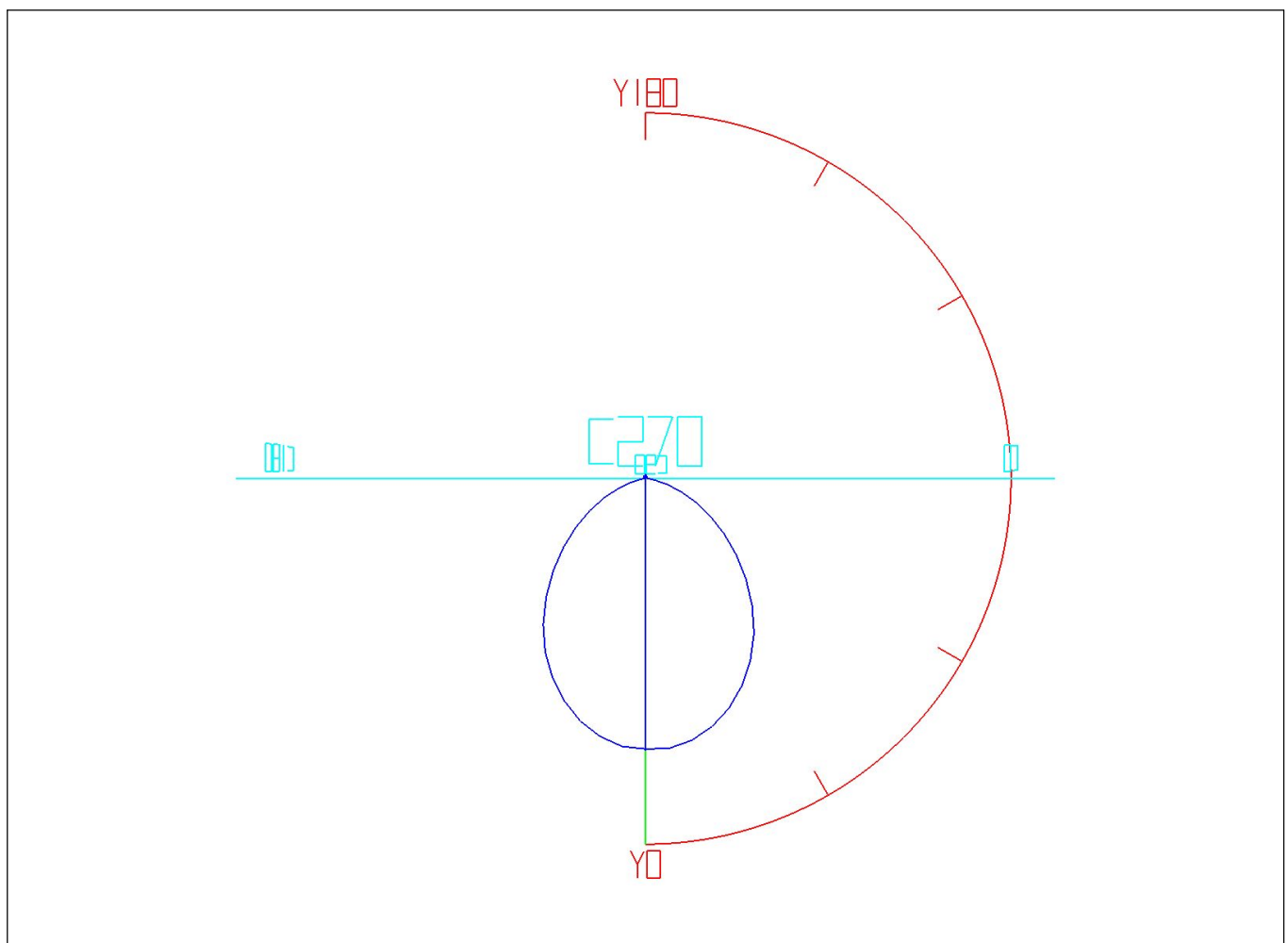

Curves: 3D Model — Fixture — Vert. HUD — Hori. HUD —
View Angles: Orient:0 Tilt:0 Roll:0 Spin:0

IES Indoor Report

Photometric Filename:ICDLT13WCCT-WH-4K.IES

Zonal Flux Tabulation

Zone (y)	Zone Flux (lm)	Sums Flux (lm)	Zone%Lamp	Sums%Lamp
0.0-5.0	11.11	11.11	1.11	1.11
5.0-10.0	32.71	43.83	3.26	4.36
10.0-15.0	52.64	96.46	5.24	9.60
15.0-20.0	69.85	166.31	6.95	16.56
20.0-25.0	83.50	249.81	8.31	24.87
25.0-30.0	93.05	342.86	9.26	34.13
30.0-35.0	98.03	440.90	9.76	43.89
35.0-40.0	98.17	539.07	9.77	53.66
40.0-45.0	93.89	632.96	9.35	63.01
45.0-50.0	86.02	718.98	8.56	71.57
50.0-55.0	75.46	794.43	7.51	79.08
55.0-60.0	63.06	857.50	6.28	85.36
60.0-65.0	49.62	907.12	4.94	90.30
65.0-70.0	35.95	943.07	3.58	93.88
70.0-75.0	22.90	965.97	2.28	96.16
75.0-80.0	11.88	977.84	1.18	97.34
80.0-85.0	4.97	982.81	0.49	97.84
85.0-90.0	1.85	984.67	0.18	98.02
90.0-95.0	0.88	985.55	0.09	98.11
95.0-100.0	0.92	986.47	0.09	98.20
100.0-105.0	1.01	987.48	0.10	98.30
105.0-110.0	1.12	988.60	0.11	98.41
110.0-115.0	1.23	989.83	0.12	98.54
115.0-120.0	1.34	991.17	0.13	98.67
120.0-125.0	1.43	992.60	0.14	98.81
125.0-130.0	1.49	994.08	0.15	98.96
130.0-135.0	1.52	995.61	0.15	99.11
135.0-140.0	1.51	997.12	0.15	99.26
140.0-145.0	1.47	998.59	0.15	99.41
145.0-150.0	1.39	999.98	0.14	99.55
150.0-155.0	1.27	1001.25	0.13	99.67
155.0-160.0	1.11	1002.36	0.11	99.78
160.0-165.0	0.92	1003.28	0.09	99.87
165.0-170.0	0.69	1003.97	0.07	99.94
170.0-175.0	0.43	1004.40	0.04	99.99
175.0-180.0	0.15	1004.54	0.01	100.00

IES Indoor Report

Photometric Filename:ICDLT13WCCT-WH-4K.IES

Rectangle ISO Lighting Intensity Diagram

Lum. Name: ICDLT13WCCT-WH	Lum. Catalog: LED DOWNLIGHT	Test ID:
Lamp Name: 4000K	Lamp Catalog: SMD2835	Test Lab:
Manufacture:	Test Machine:GON-2000	Test Date: 2020/03/16

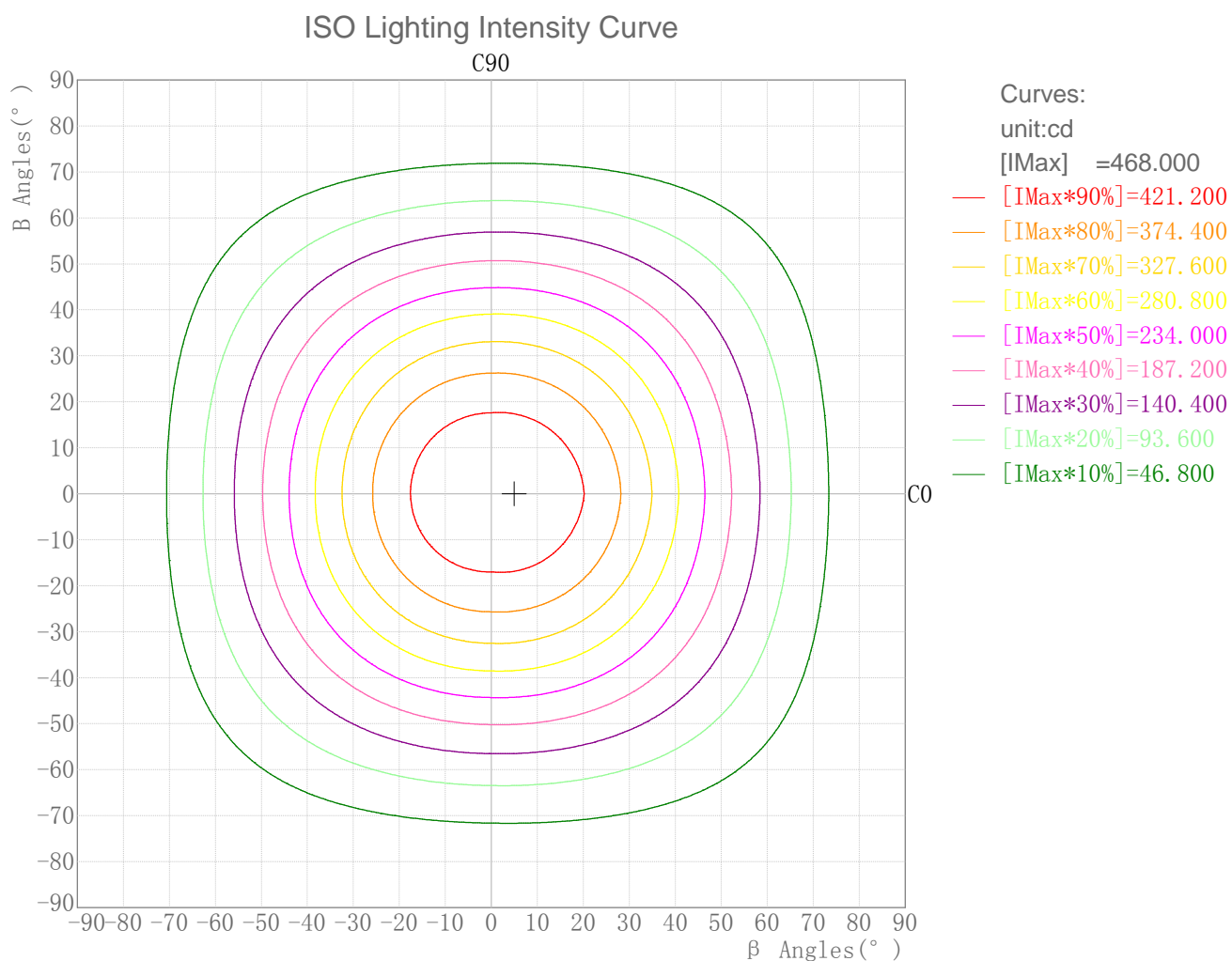

IES Indoor Report

Photometric Filename:ICDLT13WCCT-WH-4K.IES

Plane ISO-Illuminance Diagram

Lum. Name: ICDLT13WCCT-WH	Lum. Catalog: LED DOWNLIGHT	Test ID:
Lamp Name: 4000K	Lamp Catalog: SMD2835	Test Lab:
Manufacture:	Test Machine:GON-2000	Test Date: 2020/03/16

Plane ISO-Illuminance Curve

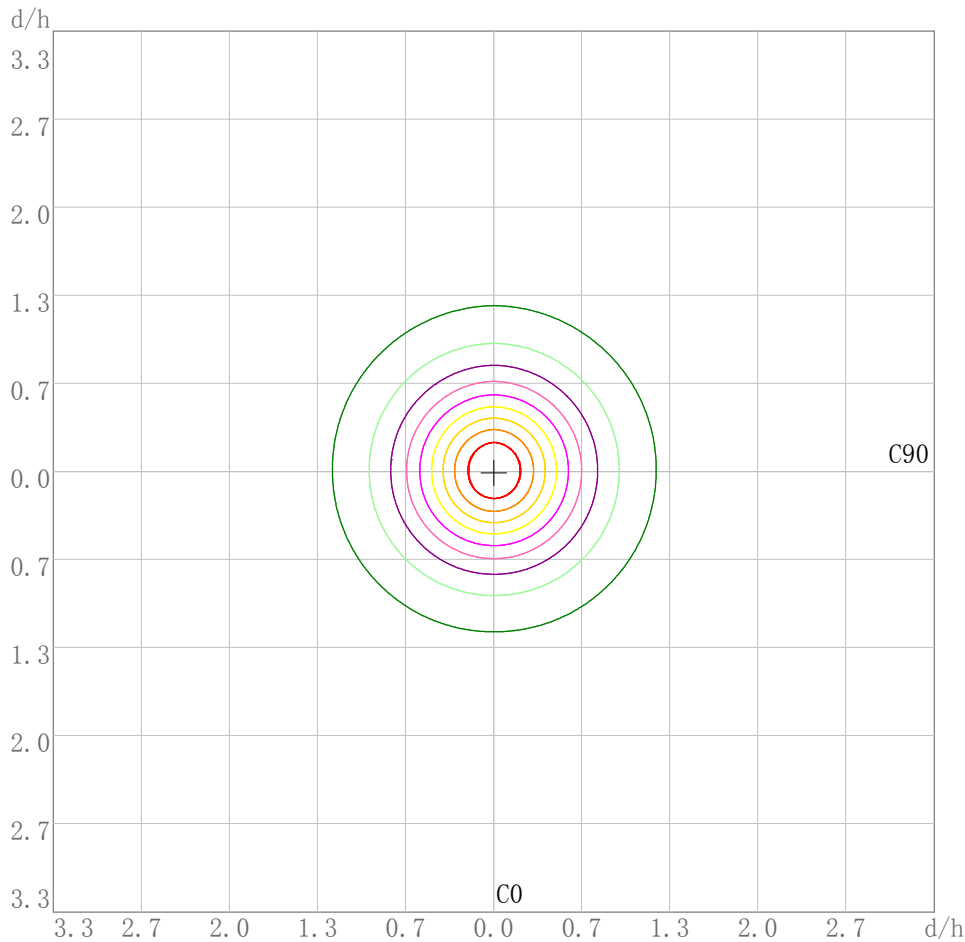

Working Plane Luminaire Mounting Height(m): 3.00
Working Plane Maximum Illuminance(lx): 51.91
Working Plane Maximum Illuminance Position(d/h):H0.0 V0.0

IES Indoor Report

Photometric Filename:ICDLT13WCCT-WH-4K.IES

3D Plane ISO Illuminance Diagram

Lum. Name: ICDLT13WCCT-WH	Lum. Catalog: LED DOWNLIGHT	Test ID:
Lamp Name: 4000K	Lamp Catalog: SMD2835	Test Lab:
Manufacture:	Test Machine:GON-2000	Test Date: 2020/03/16

3D Plane Illuminance Modal

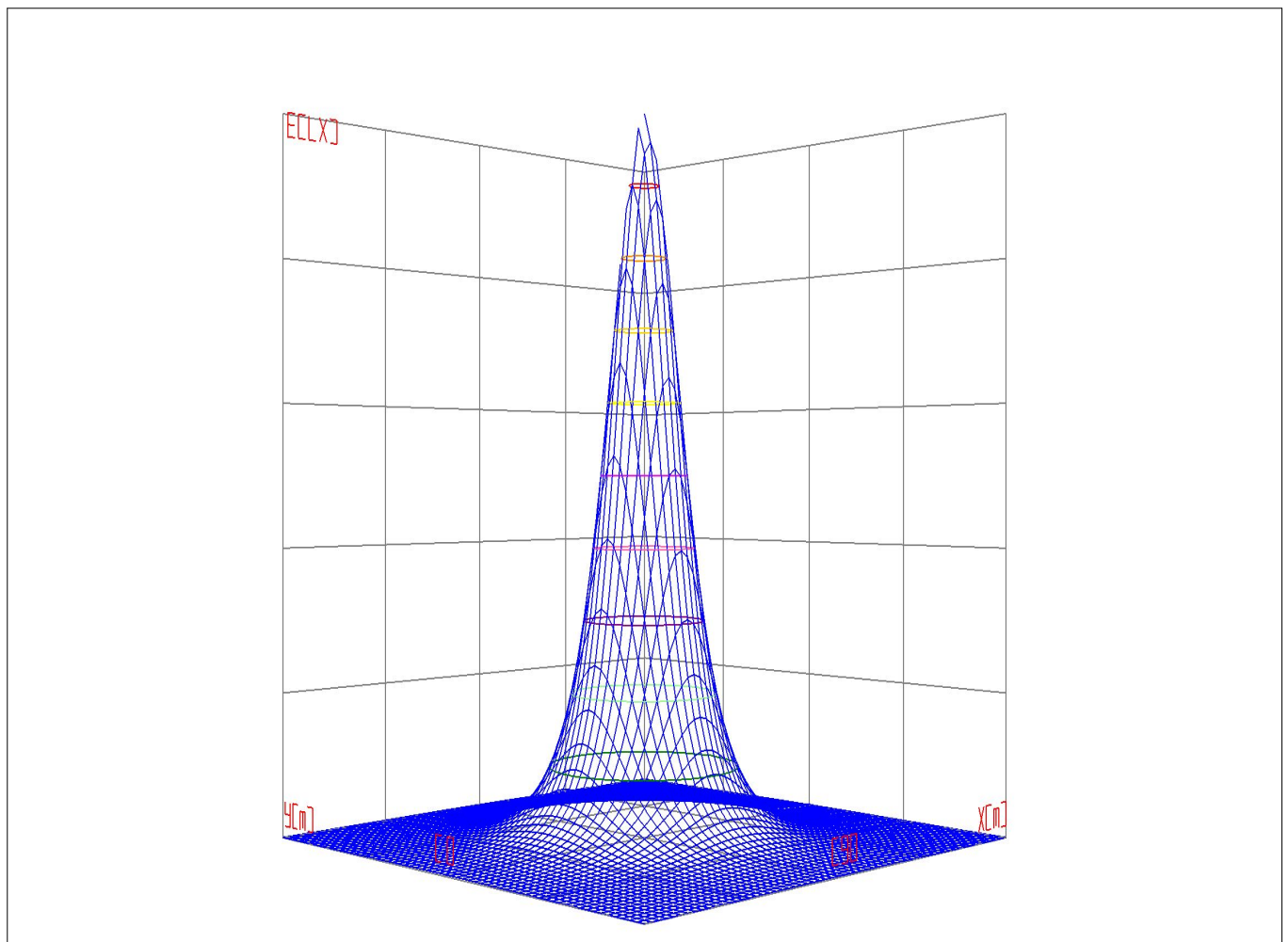

Curves: 3D Model — 90% — 80% — 70% — 60% — 50% — 40% — 30% — 20% — 10% —
View Angles(deg): 0 Height(m): 3.0 Distance(m): 10.0

IES Indoor Report

Photometric Filename:ICDLT13WCCT-WH-4K.IES

Space ISO Illuminance Diagram

Lum. Name: ICDLT13WCCT-WH	Lum. Catalog: LED DOWNLIGHT	Test ID:
Lamp Name: 4000K	Lamp Catalog: SMD2835	Test Lab:
Manufacture:	Test Machine:GON-2000	Test Date: 2020/03/16

Space ISO Illuminance Curve

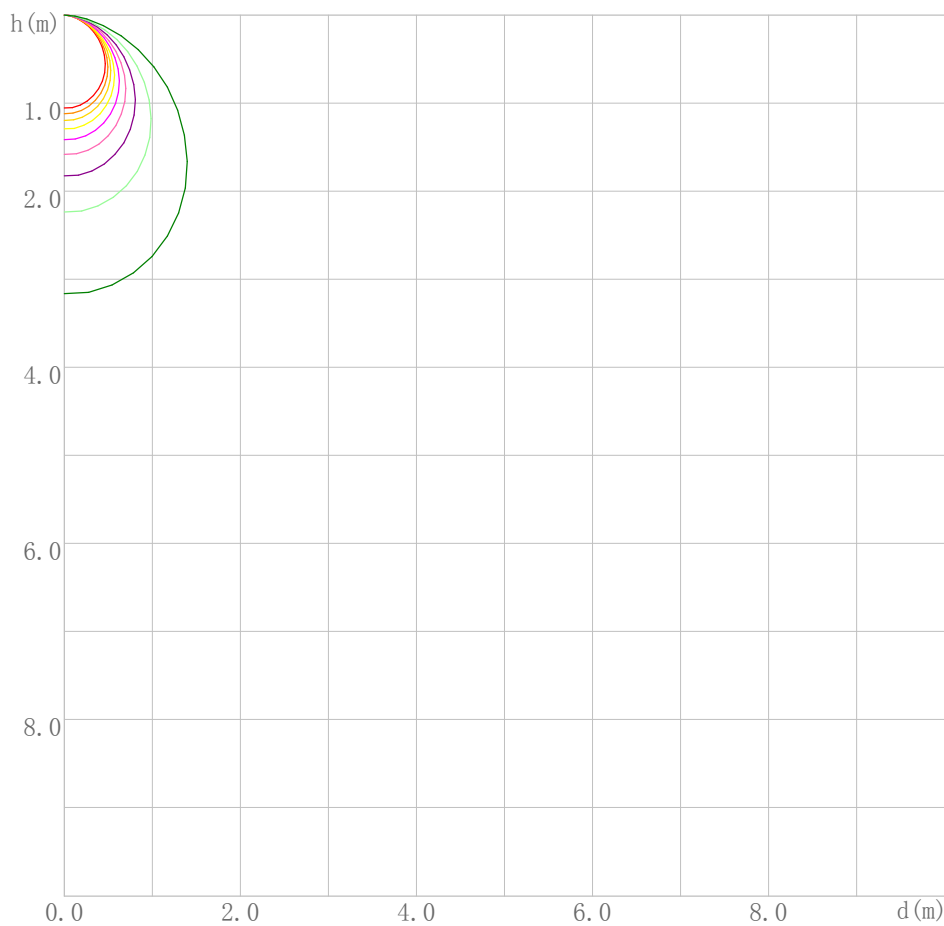

- Curves:
unit:lx
[EMax] =467.128
- [EMax*90%]=420.415
 - [EMax*80%]=373.702
 - [EMax*70%]=326.990
 - [EMax*60%]=280.277
 - [EMax*50%]=233.564
 - [EMax*40%]=186.851
 - [EMax*30%]=140.138
 - [EMax*20%]=93.426
 - [EMax*10%]=46.713

Space Plane Maximum Illuminance and @Angle:467.13,0.0deg
Plane Maximum Lighting Intensity and @Angle:468.000cd,0deg

IES Indoor Report

Photometric Filename:ICDLT13WCCT-WH-4K.IES

Illuminance-Distance Diagram

Lum. Name: ICDLT13WCCT-WH	Lum. Catalog: LED DOWNLIGHT	Test ID:
Lamp Name: 4000K	Lamp Catalog: SMD2835	Test Lab:
Manufacture:	Test Machine:GON-2000	Test Date: 2020/03/16

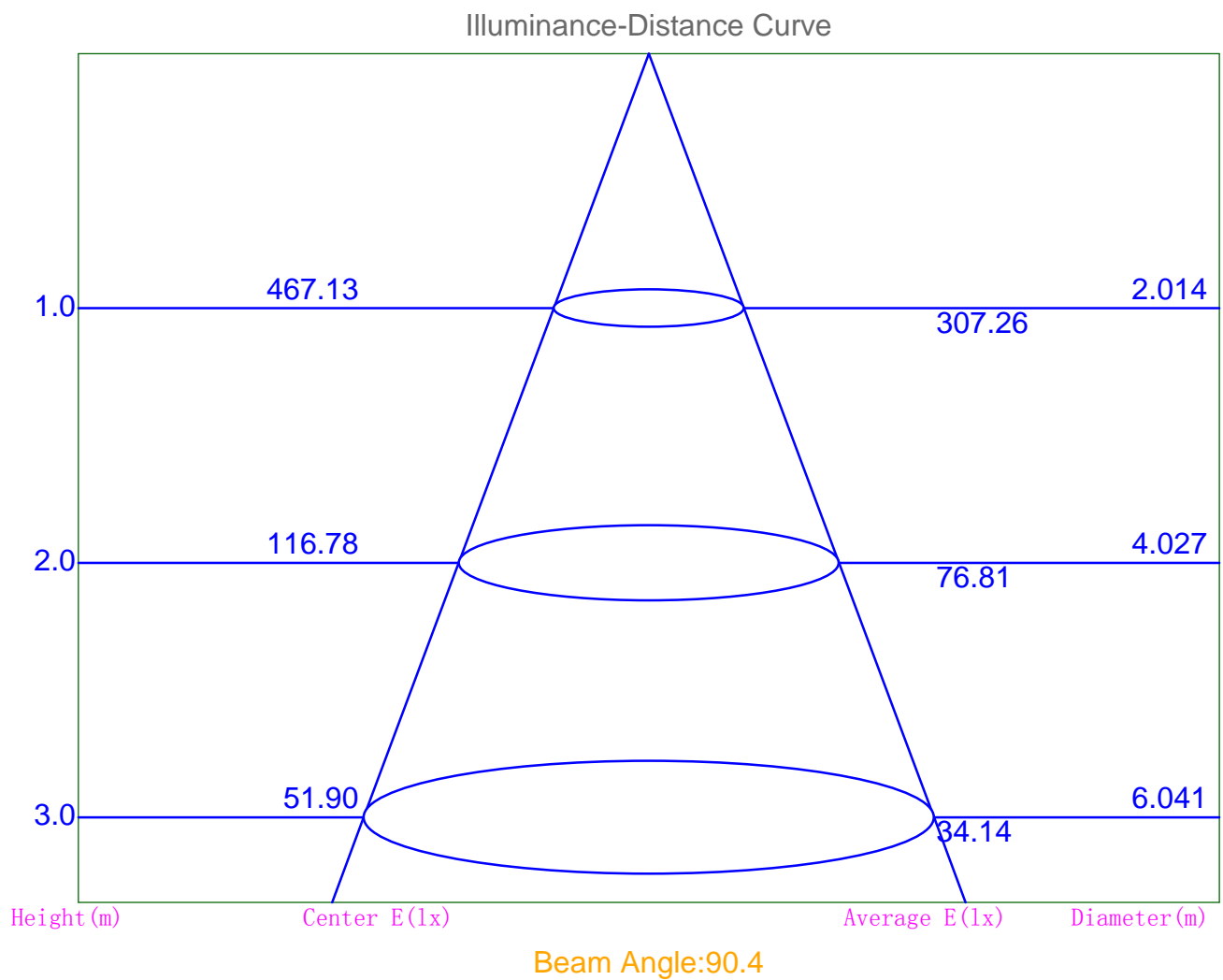

Indoor Luminance Limiting Curves

Lum. Name: ICDLT13WCCT-WH	Lum. Catalog: LED DOWNLIGHT	Test ID:
Lamp Name: 4000K	Lamp Catalog: SMD2835	Test Lab:
Manufacture:	Test Machine:GON-2000	Test Date: 2020/03/16

Glare Grade Table

GI	Quality	Using Illuminance							
		a	b	c	d	e	f	g	h
1.15	A	2000	1000	500	<=300				
1.5	B		2000	1000	500	<=300			
1.85	C			2000	1000	500	<=300		
2.2	D				2000	1000	500	<=300	
2.55	E	a				2000	1000	500	<=300
			b	c	d	e	f	g	h

Luminance Table

Gama (deg)	45	50	55	60	65	70	75	80	85
C0	17992	16500	14957	13340	11640	9784	7630	5311	4553
C90	17020	15493	13905	12243	10449	8489	6240	3833	2613

Luminance Limiting Curve

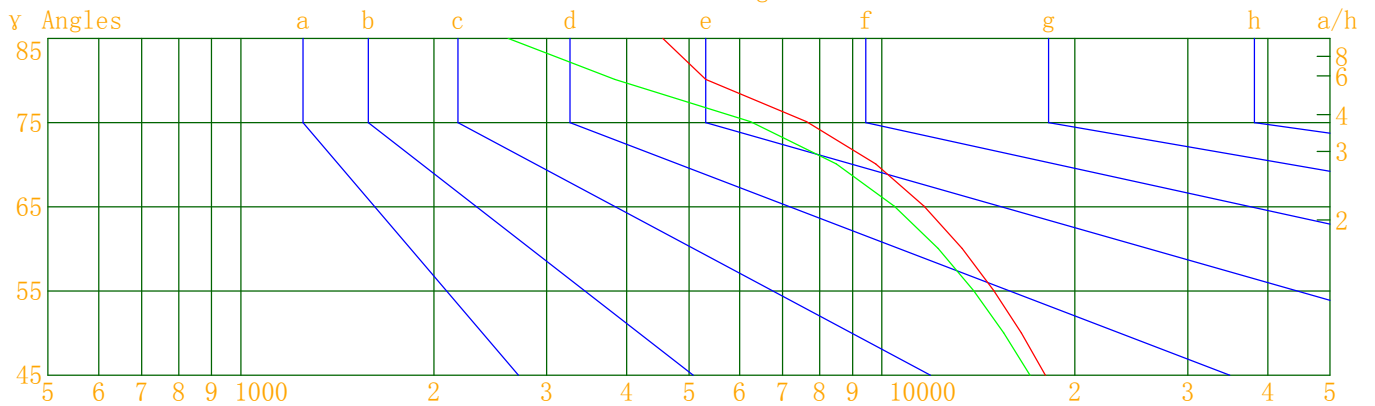

Luminous Size: Length(m)=0.115 Width(m)=0.115 Height(m)=0.053 Area(m²)=0.019320
 Luminous Type: Without Luminous Side
 Luminous Curves: C0-C180 Color: ——— C90-C270 Color: ———

IES Indoor Report

Photometric Filename:ICDLT13WCCT-WH-4K.IES

Indoor Budgetary Estimate Table

Lum. Name: ICDLT13WCCT-WH	Lum. Catalog: LED DOWNLIGHT	Test ID:
Lamp Name: 4000K	Lamp Catalog: SMD2835	Test Lab:
Manufacture:	Test Machine:GON-2000	Test Date: 2020/03/16

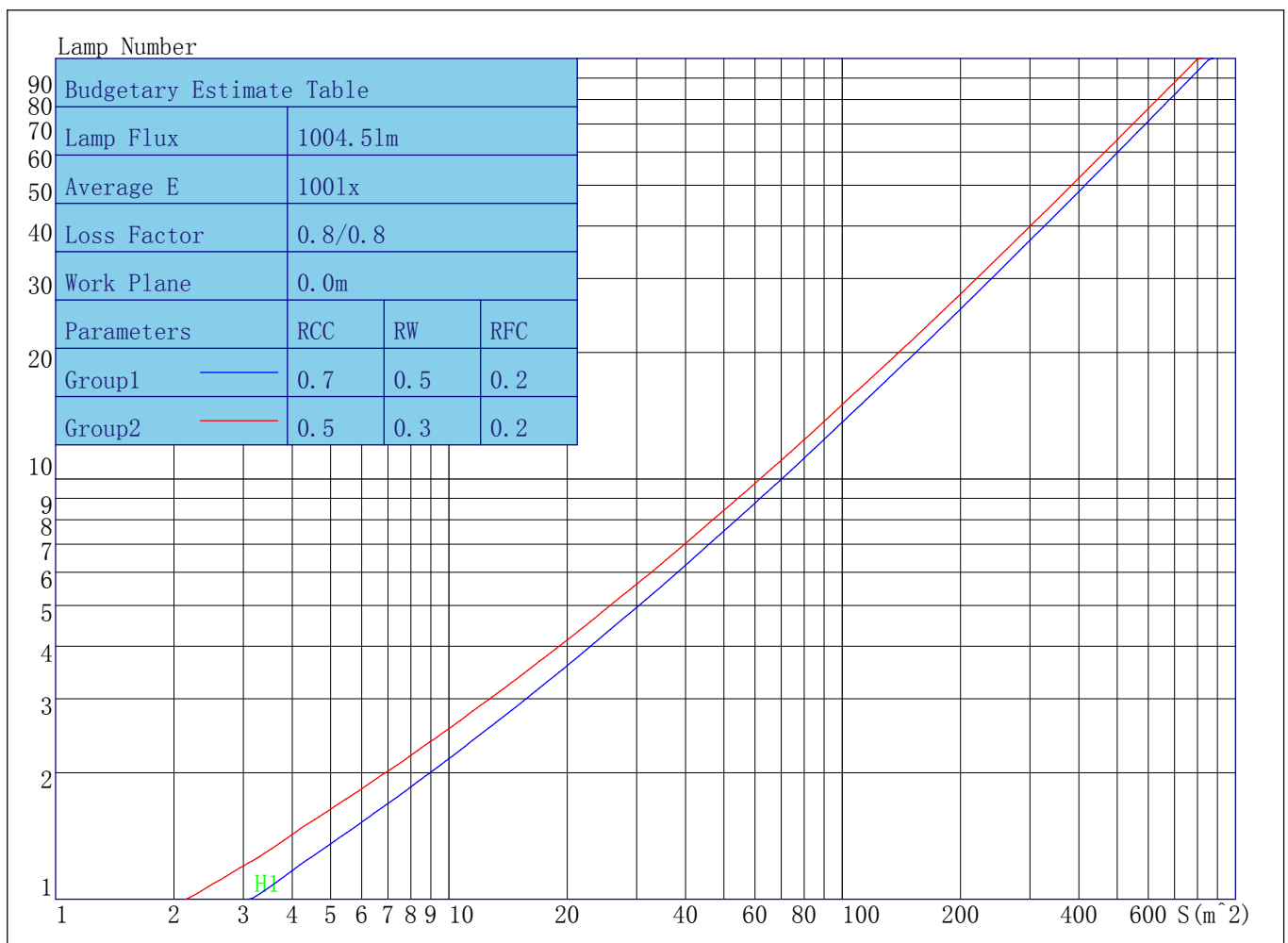

Parameters1: Rhocc = 0.7 Rhow = 0.5 Rhofc = 0.2 LLF = 0.8
 Parameters2: Rhocc = 0.5 Rhow = 0.3 Rhofc = 0.2 LLF = 0.8
 Average Illuminance(lx): 100 Cavity Height: H1(m) = 2

IES Indoor Report

Photometric Filename:ICDLT13WCCT-WH-4K.IES

Indoor Coefficient of Utilization Table

Lum. Name: ICDLT13WCCT-WH	Lum. Catalog: LED DOWNLIGHT	Test ID:
Lamp Name: 4000K	Lamp Catalog: SMD2835	Test Lab:
Manufacture:	Test Machine:GON-2000	Test Date: 2020/03/16

Coefficients of Utilization - Zonal Cavity Method																		
Coef.	Effective Floor Cavity Reflectance RFC=0.20																	
RhoCC (%)	80				70				50			30			10			0
RhoW (%)	70	50	30	10	70	50	30	10	50	30	10	50	30	10	50	30	10	0
RCR	Coefficient of Utilization(%)																	
0	119	119	119	119	116	116	116	116	110	110	110	105	105	105	100	100	100	98
1	110	106	102	99	107	103	100	97	99	96	94	95	92	90	91	89	87	85
2	101	94	88	83	98	92	86	82	88	83	79	85	81	77	81	78	75	73
3	93	84	76	70	90	82	75	70	79	73	68	76	71	67	73	69	65	63
4	86	75	67	61	83	73	66	60	71	64	59	68	63	58	66	61	57	55
5	79	68	59	53	77	66	59	53	64	57	52	62	56	51	60	55	51	49
6	74	61	53	47	72	60	52	47	58	51	46	56	50	46	55	49	45	43
7	69	56	48	42	67	55	47	42	53	46	41	52	46	41	50	45	41	39
8	64	51	43	38	62	51	43	38	49	42	37	48	42	37	46	41	37	35
9	60	47	40	34	58	47	39	34	45	39	34	44	38	34	43	37	33	32
10	56	44	36	31	55	43	36	31	42	36	31	41	35	31	40	35	31	29

IES Indoor Report

Photometric Filename:ICDLT13WCCT-WH-4K.IES

Unified Glare Rating Table

Lum. Name: ICDLT13WCCT-WH	Lum. Catalog: LED DOWNLIGHT	Test ID:
Lamp Name: 4000K	Lamp Catalog: SMD2835	Test Lab:
Manufacture:	Test Machine:GON-2000	Test Date: 2020/03/16

Unified Glare Rating Table

Ceiling RCC	0.70	0.70	0.50	0.50	0.30	0.70	0.70	0.50	0.50	0.30	
Wall RW	0.50	0.30	0.50	0.30	0.30	0.50	0.30	0.50	0.30	0.30	
Floor RFC	0.20	0.20	0.20	0.20	0.20	0.20	0.20	0.20	0.20	0.20	
Room Size	Vewed crosswise					Vewed endwise					
X=2H	Y=2H	36.3	39.4	37.1	40.2	40.9	35.8	39.0	36.7	39.8	40.5
	Y=3H	39.2	42.4	40.0	43.1	43.8	38.5	41.7	39.3	42.4	43.1
	Y=4H	41.0	43.7	41.8	44.4	45.1	40.1	42.8	41.0	43.6	44.3
	Y=6H	41.7	44.3	42.5	45.0	45.7	40.6	43.2	41.5	44.0	44.7
	Y=8H	41.8	44.4	42.7	45.2	45.9	40.7	43.3	41.5	44.0	44.8
	Y=12H	41.9	44.5	42.8	45.2	46.0	40.7	43.3	41.6	44.0	44.8
X=4H	Y=2H	37.2	39.9	38.1	40.7	41.4	36.9	39.6	37.7	40.3	41.1
	Y=3H	40.3	43.0	41.2	43.7	44.5	39.7	42.4	40.6	43.2	43.9
	Y=4H	40.5	42.0	41.6	43.0	43.9	39.8	41.2	40.9	42.2	43.1
	Y=6H	41.5	42.8	42.5	43.8	44.7	40.5	41.8	41.6	42.8	43.7
	Y=8H	41.7	43.0	42.8	44.0	44.9	40.7	42.0	41.8	43.0	43.9
	Y=12H	41.1	42.1	42.2	43.2	44.2	39.9	40.9	41.1	42.0	43.0
X=8H	Y=4H	40.6	41.9	41.7	42.9	43.8	39.9	41.2	41.0	42.2	43.1
	Y=6H	40.8	41.7	42.0	42.8	43.8	39.9	40.8	41.1	41.9	42.9
	Y=8H	40.7	41.3	41.9	42.5	43.6	39.7	40.4	40.9	41.5	42.6
	Y=12H	41.0	41.6	42.2	42.8	43.9	39.8	40.5	41.1	41.7	42.7
X=12H	Y=4H	39.7	40.7	40.9	41.8	42.8	39.0	40.0	40.2	41.1	42.1
	Y=6H	40.3	41.0	41.5	42.2	43.2	39.4	40.1	40.7	41.3	42.4
	Y=8H	40.6	41.3	41.9	42.5	43.5	39.7	40.3	40.9	41.5	42.6
Variations with the objver position at spacings											
	S=1.0H	3.2/-1.1					3.3/-0.8				
	S=1.5H	-1.1/-21.3					-0.7/-20.6				
	S=2.0H	-1.1/-21.3					-0.7/-20.6				

IES Indoor Report

Photometric Filename:ICDLT13WCCT-WH-4K.IES

Candela Tabulation

V/H	C0.0	C90.0	C180.0	C270.0
Y 0.0	467.13	467.13	467.13	467.13
Y 5.0	468.00	459.01	464.49	458.21
Y 10.0	459.37	449.21	452.32	447.42
Y 15.0	443.87	432.96	433.93	430.28
Y 20.0	422.21	410.35	409.15	407.33
Y 25.0	394.77	382.30	379.78	378.77
Y 30.0	362.71	350.16	346.27	346.29
Y 35.0	327.12	313.43	307.83	309.08
Y 40.0	287.06	273.38	266.73	269.08
Y 45.0	245.80	232.52	225.24	228.45
Y 50.0	204.90	192.41	184.71	188.76
Y 55.0	165.74	154.09	146.55	151.01
Y 60.0	128.87	118.27	111.02	115.79
Y 65.0	95.04	85.32	78.53	83.68
Y 70.0	64.65	56.09	49.68	54.89
Y 75.0	38.15	31.20	25.74	30.00
Y 80.0	17.82	12.86	9.61	12.15
Y 85.0	7.67	4.40	3.51	5.14
Y 90.0	2.42	0.70	0.97	2.27
Y 95.0	2.20	0.94	1.20	2.17
Y 100.0	2.20	1.14	1.43	2.27
Y 105.0	2.38	1.50	1.76	2.39
Y 110.0	2.57	1.78	2.11	2.66
Y 115.0	2.87	2.17	2.46	2.86
Y 120.0	3.13	2.49	2.88	3.18
Y 125.0	3.45	2.89	3.20	3.46
Y 130.0	3.74	3.24	3.65	3.74
Y 135.0	4.12	3.61	3.94	4.09
Y 140.0	4.38	3.94	4.33	4.33
Y 145.0	4.70	4.27	4.64	4.64
Y 150.0	5.02	4.59	4.97	4.88
Y 155.0	5.27	4.91	5.30	5.19
Y 160.0	5.56	5.23	5.57	5.41
Y 165.0	5.78	5.46	5.87	5.67
Y 170.0	6.01	5.74	6.08	5.90
Y 175.0	6.15	5.90	6.26	6.06
Y 180.0	6.19	6.19	6.19	6.19
