

IES Indoor Report

Photometric Filename:ICD0LR16015WCCT-WH 3K.IES

Indoor Luminaire Photometric Data

Description Information

Lum. Name: ICDLR16015WCCT-WH	Lum. Catalog: LED DOWNLIGHT	Test ID:
Lamp Name: 3000K	Lamp Catalog: SMD2835	Test Date: 2020/05/31
Manufacture:	ShldAngle(°):	Test Machine:GON-2000
Test Lab:	Frequency(Hz):	Lamp CCT(K): Ra:
Lum. Size(W*L*H):0.160m*0.160m*0.046m	Lum. Area(m2):0.033	Lum. W(kg): 2.000
Test System: C, γ	Test Step: C=90.0 γ=5.0	Temp.(°C): 25
		Humidity(%):

Character Parameter

Lamp Speciality Parameter	Luminaire Speciality Parameter	
Rated Flux(lm): 1329.070	Luminaire Flux: 1329.070lm	Field Angle(10%Imax): 145.1
Rated Power(W):	Luminaire Efficiency: 100.00%	Down Lumens&Percent: 1327.172lm 99.86%
Rated Voltage(V):	Luminaire EER(lm/W): 87.496	Up Lumens&Percent: 1.899lm 0.14%
Tested Power(W): 15.190	Max. Cand. (cd): 620.594	S/MH: C0_a180=1.149 C90_270=1.138
Lamps' Inside: 1	Max Cand@Ang. (°): C=0.0 γ=5.0	CIE Type: Semi-Direct
Tested Electric:U=238.9V, I=0.065A, PF=0.000	Beam Angle(50%Imax): 90.9	ErP Φuse(120°): 1135.150lm
Lamp Size(W*L*H):0.160m*0.160m*0.046m	Left=-43.6 Right=47.4	IRF: 126.290%

Lighting Distribution Diagram

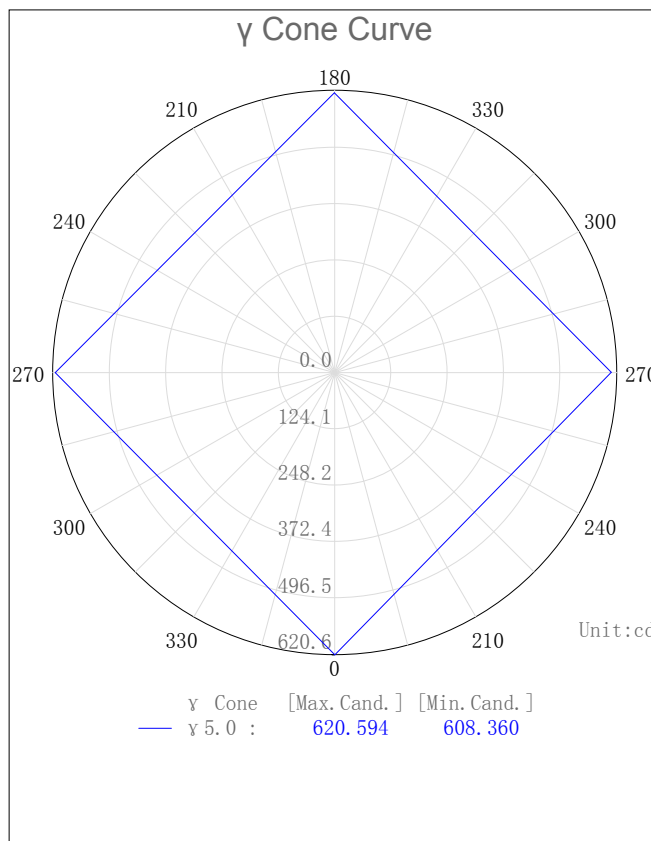
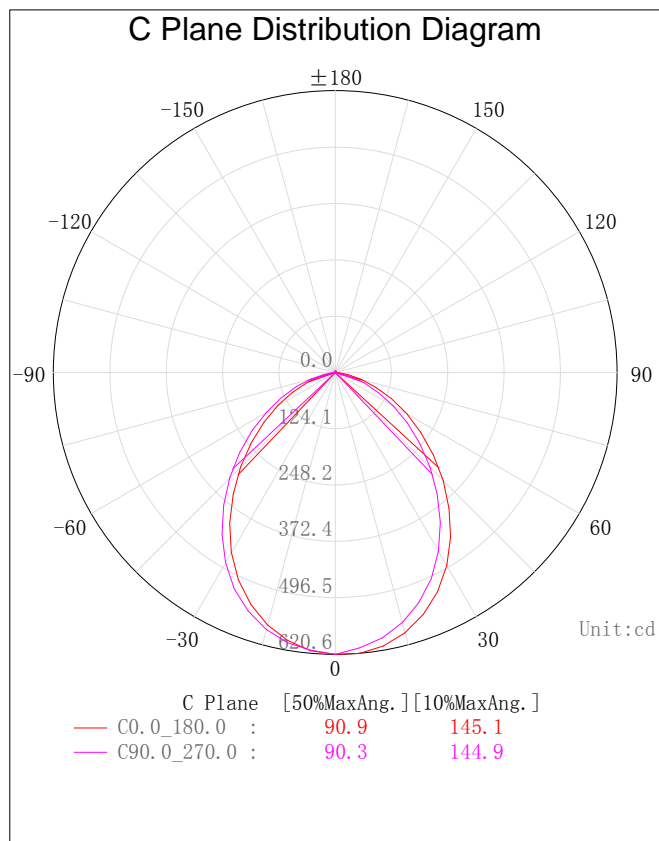

IES Indoor Report

Photometric Filename:ICD0LR16015WCCT-WH 3K.IES

3D Light Intensity Distribution Modal

Lum. Name: ICDLR16015WCCT-WH	Lum. Catalog: LED DOWNLIGHT	Test ID:
Lamp Name: 3000K	Lamp Catalog: SMD2835	Test Lab:
Manufacture:	Test Machine:GON-2000	Test Date: 2020/05/31

3D Light Intensity Distribution Modal

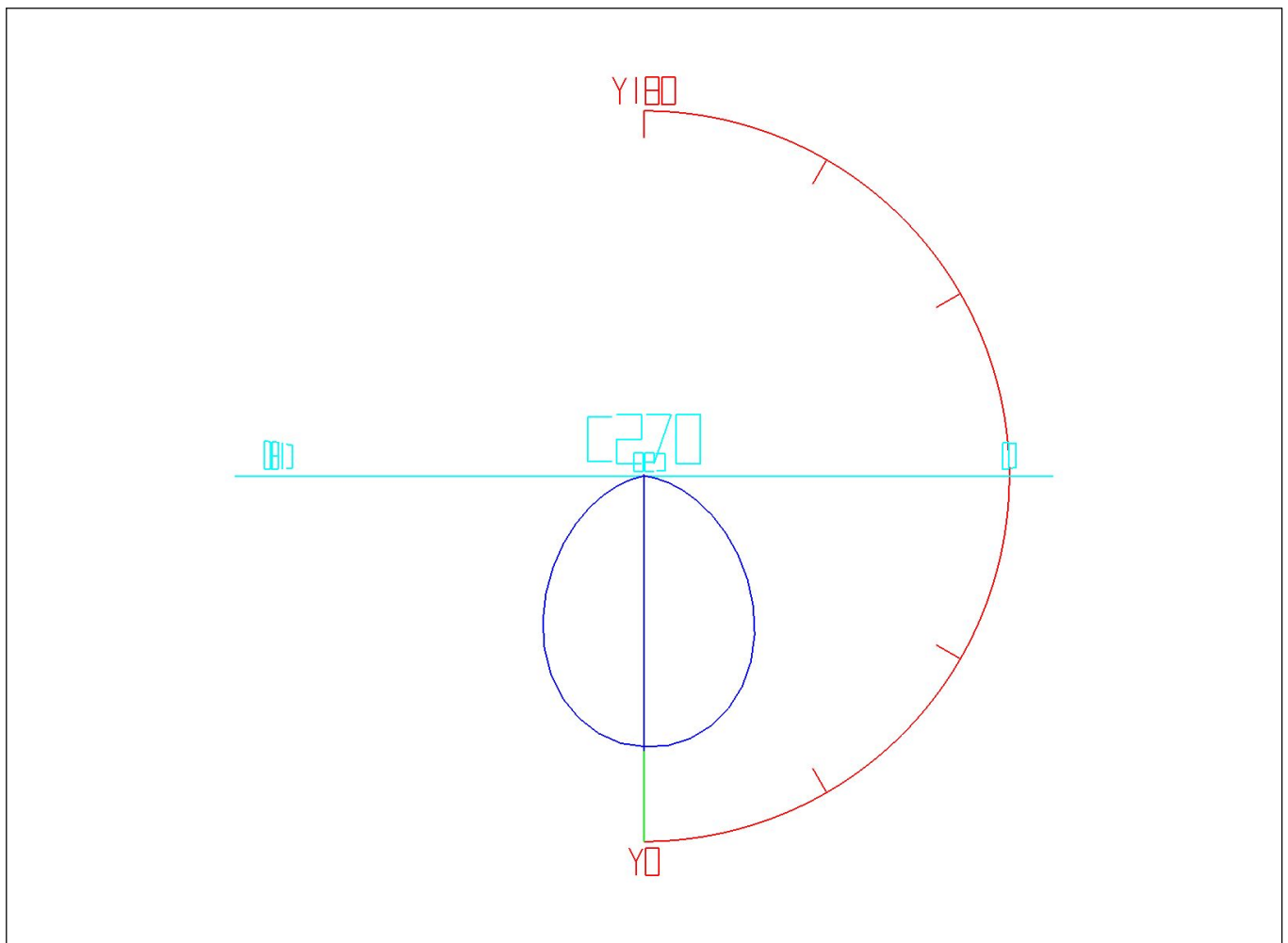

Curves: 3D Model ——— Fixture ——— Vert. HUD ——— Hori. HUD ———
View Angles: Orient:0 Tilt:0 Roll:0 Spin:0

IES Indoor Report

Photometric Filename:ICD0LR16015WCCT-WH 3K.IES

Zonal Flux Tabulation

Zone (y)	Zone Flux (lm)	Sums Flux (lm)	Zone%Lamp	Sums%Lamp
0.0-5.0	14.76	14.76	1.11	1.11
5.0-10.0	43.50	58.26	3.27	4.38
10.0-15.0	70.14	128.40	5.28	9.66
15.0-20.0	93.34	221.74	7.02	16.68
20.0-25.0	111.93	333.67	8.42	25.11
25.0-30.0	124.82	458.49	9.39	34.50
30.0-35.0	131.35	589.84	9.88	44.38
35.0-40.0	131.59	721.43	9.90	54.28
40.0-45.0	126.14	847.56	9.49	63.77
45.0-50.0	115.95	963.51	8.72	72.50
50.0-55.0	102.15	1065.67	7.69	80.18
55.0-60.0	85.93	1151.59	6.47	86.65
60.0-65.0	68.31	1219.90	5.14	91.79
65.0-70.0	50.23	1270.13	3.78	95.57
70.0-75.0	32.77	1302.90	2.47	98.03
75.0-80.0	17.28	1320.18	1.30	99.33
80.0-85.0	6.05	1326.23	0.46	99.79
85.0-90.0	0.94	1327.17	0.07	99.86
90.0-95.0	0.00	1327.17	0.00	99.86
95.0-100.0	0.00	1327.17	0.00	99.86
100.0-105.0	0.00	1327.17	0.00	99.86
105.0-110.0	0.00	1327.17	0.00	99.86
110.0-115.0	0.00	1327.17	0.00	99.86
115.0-120.0	0.00	1327.17	0.00	99.86
120.0-125.0	0.00	1327.17	0.00	99.86
125.0-130.0	0.00	1327.17	0.00	99.86
130.0-135.0	0.00	1327.17	0.00	99.86
135.0-140.0	0.04	1327.21	0.00	99.86
140.0-145.0	0.14	1327.35	0.01	99.87
145.0-150.0	0.24	1327.59	0.02	99.89
150.0-155.0	0.31	1327.90	0.02	99.91
155.0-160.0	0.33	1328.23	0.03	99.94
160.0-165.0	0.32	1328.55	0.02	99.96
165.0-170.0	0.27	1328.82	0.02	99.98
170.0-175.0	0.18	1329.01	0.01	100.00
175.0-180.0	0.07	1329.07	0.00	100.00

IES Indoor Report

Photometric Filename:ICD0LR16015WCCT-WH 3K.IES

Rectangle ISO Lighting Intensity Diagram

Lum. Name: ICDLR16015WCCT-WH	Lum. Catalog: LED DOWNLIGHT	Test ID:
Lamp Name: 3000K	Lamp Catalog: SMD2835	Test Lab:
Manufacture:	Test Machine:GON-2000	Test Date: 2020/05/31

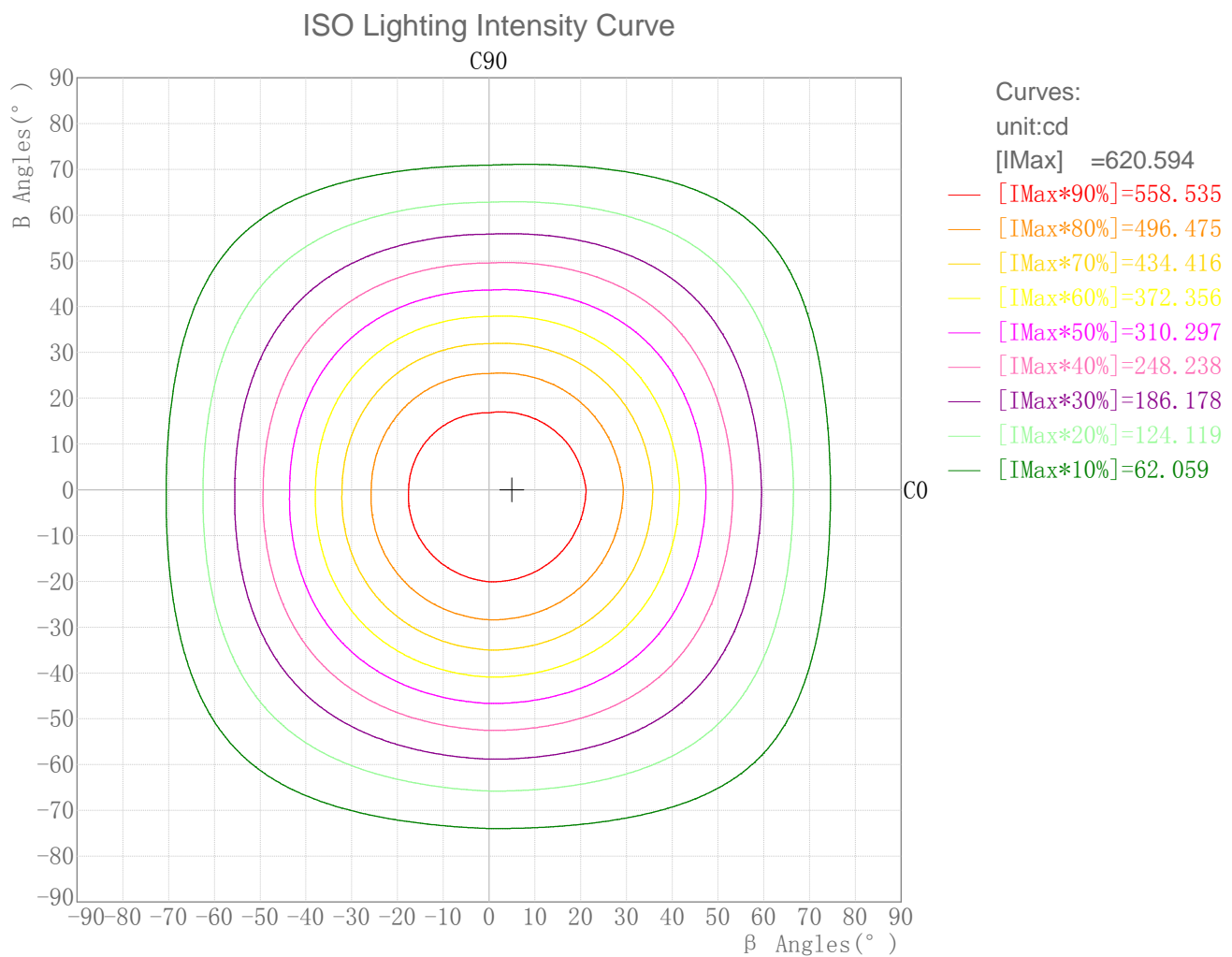

IES Indoor Report

Photometric Filename:ICDLR16015WCCT-WH 3K.IES

Plane ISO-Illuminance Diagram

Lum. Name: ICDLR16015WCCT-WH	Lum. Catalog: LED DOWNLIGHT	Test ID:
Lamp Name: 3000K	Lamp Catalog: SMD2835	Test Lab:
Manufacture:	Test Machine:GON-2000	Test Date: 2020/05/31

Plane ISO-Illuminance Curve

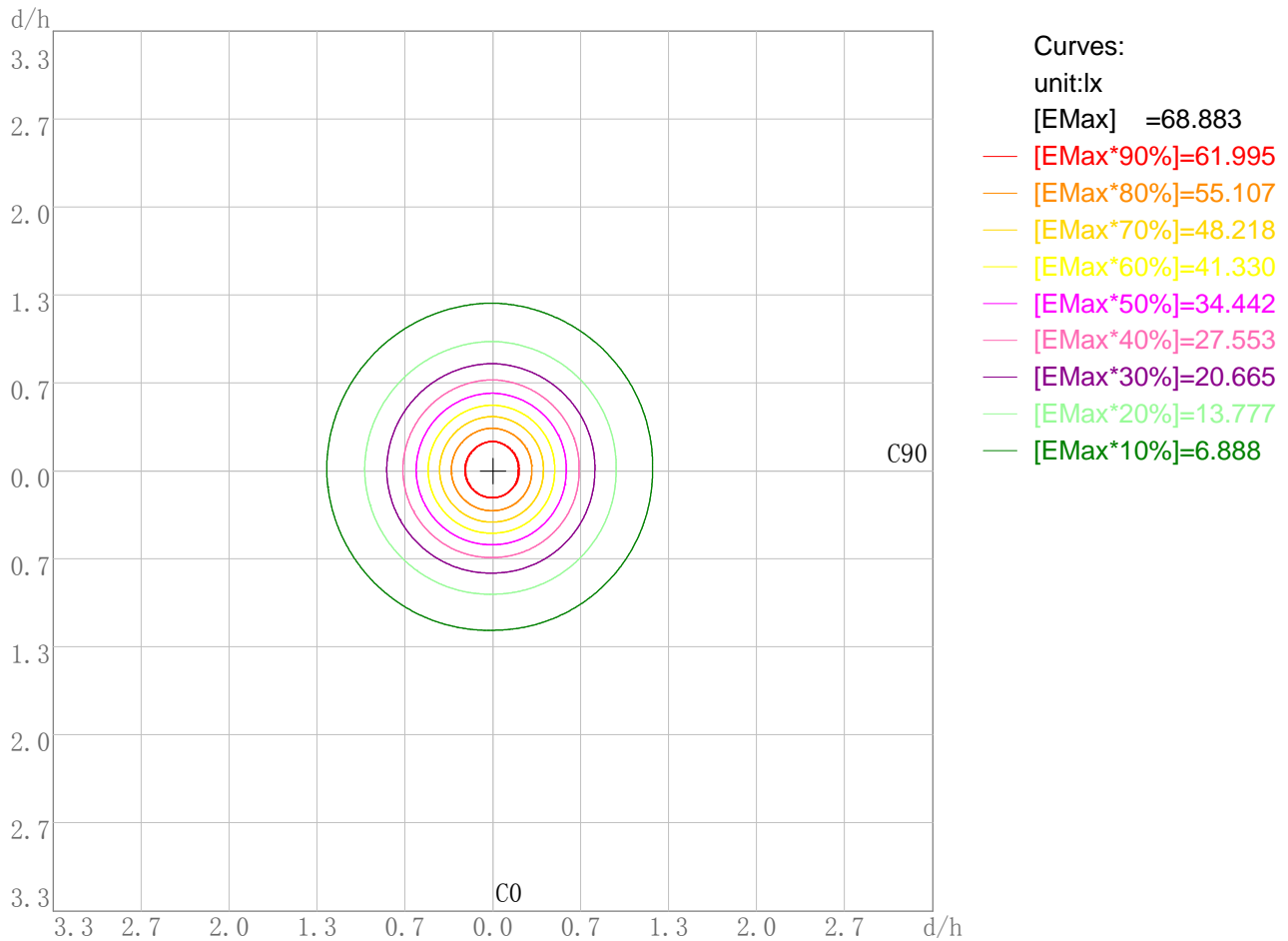

Working Plane Luminaire Mounting Height(m): 3.00
 Working Plane Maximum Illuminance(lx): 68.88
 Working Plane Maximum Illuminance Position(d/h):H0.0 V0.0

IES Indoor Report

Photometric Filename:ICD0LR16015WCCT-WH 3K.IES

3D Plane ISO Illuminance Diagram

Lum. Name: ICDLR16015WCCT-WH	Lum. Catalog: LED DOWNLIGHT	Test ID:
Lamp Name: 3000K	Lamp Catalog: SMD2835	Test Lab:
Manufacture:	Test Machine:GON-2000	Test Date: 2020/05/31

3D Plane Illuminance Modal

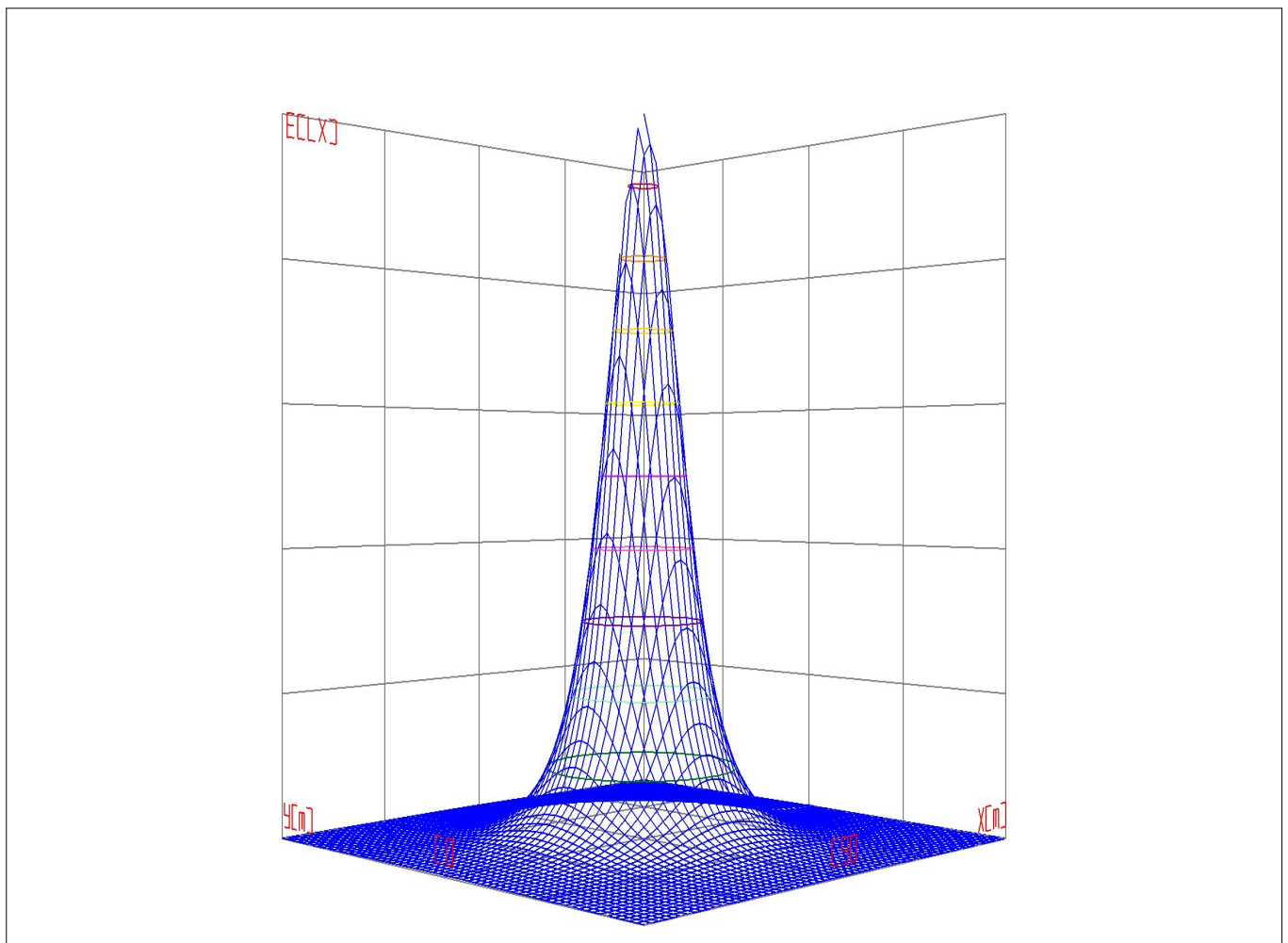

Curves: 3D Model — 90% — 80% — 70% — 60% — 50% — 40% — 30% — 20% — 10% —
View Angles(deg): 0 Height(m): 3.0 Distance(m): 10.0

IES Indoor Report

Photometric Filename:ICD0LR16015WCCT-WH 3K.IES

Space ISO Illuminance Diagram

Lum. Name: ICDLR16015WCCT-WH	Lum. Catalog: LED DOWNLIGHT	Test ID:
Lamp Name: 3000K	Lamp Catalog: SMD2835	Test Lab:
Manufacture:	Test Machine:GON-2000	Test Date: 2020/05/31

Space ISO Illuminance Curve

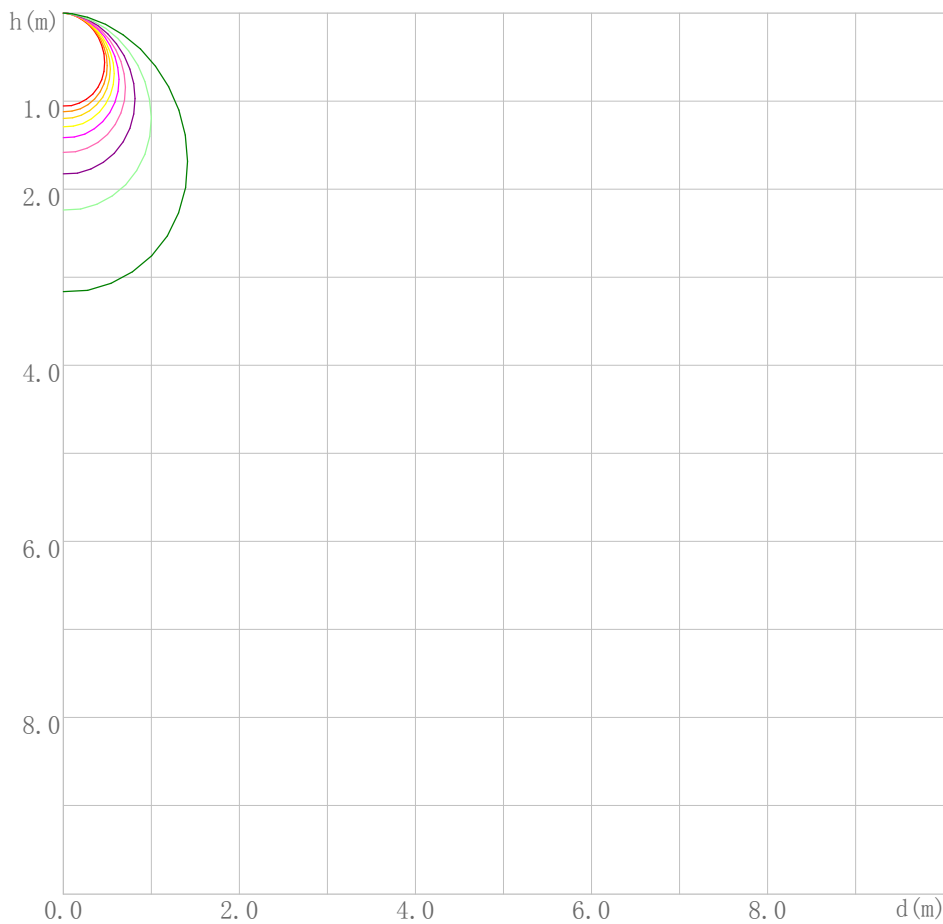

- Curves:
unit:lx
[EMax] =619.949
- [EMax*90%]=557.954
 - [EMax*80%]=495.959
 - [EMax*70%]=433.964
 - [EMax*60%]=371.969
 - [EMax*50%]=309.974
 - [EMax*40%]=247.980
 - [EMax*30%]=185.985
 - [EMax*20%]=123.990
 - [EMax*10%]=61.995

Space Plane Maximum Illuminance and @Angle:619.95,0.0deg
Plane Maximum Lighting Intensity and @Angle:620.594cd,0deg

IES Indoor Report

Photometric Filename:ICD0LR16015WCCT-WH 3K.IES

Illuminance-Distance Diagram

Lum. Name: ICDLR16015WCCT-WH	Lum. Catalog: LED DOWNLIGHT	Test ID:
Lamp Name: 3000K	Lamp Catalog: SMD2835	Test Lab:
Manufacture:	Test Machine:GON-2000	Test Date: 2020/05/31

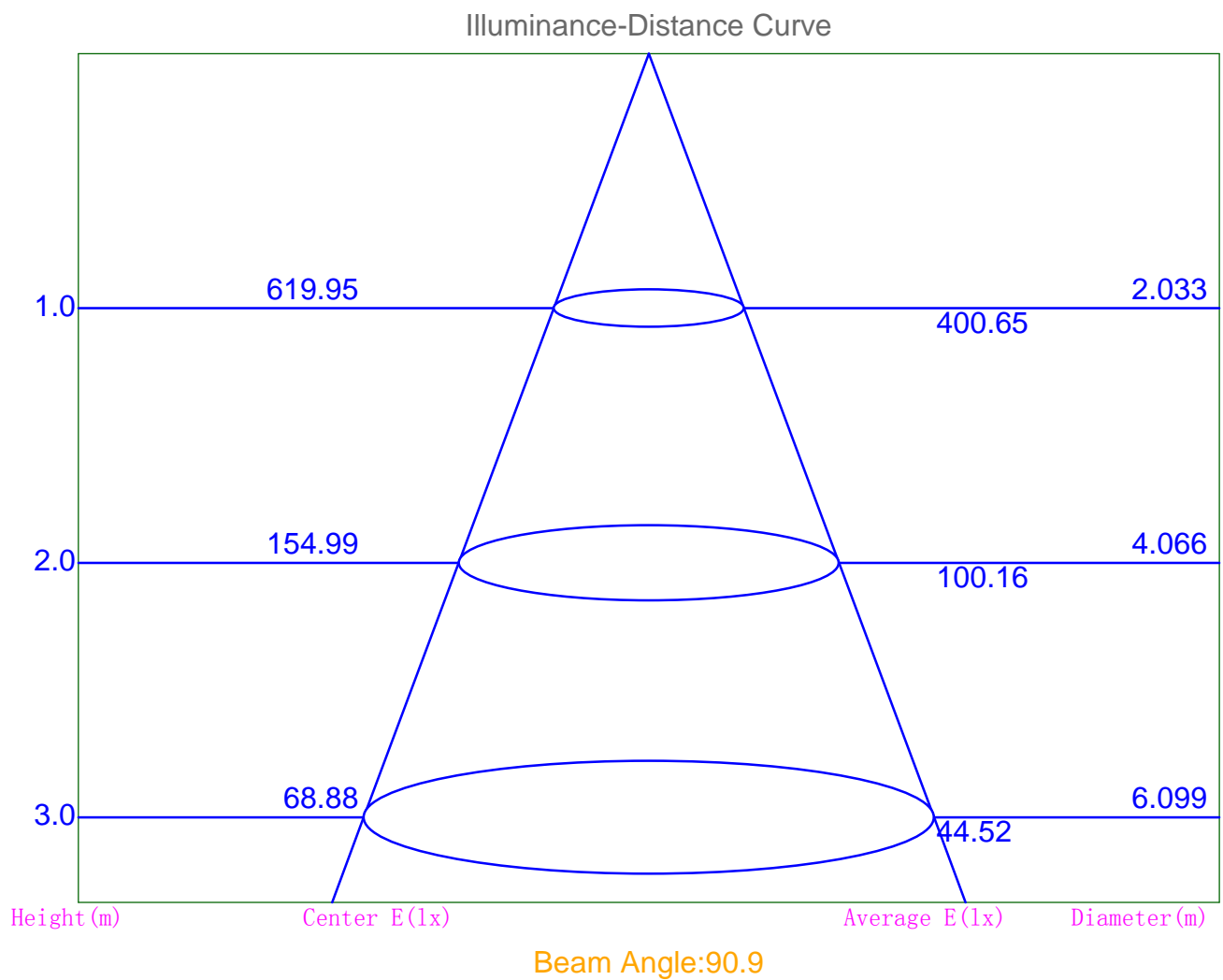

IES Indoor Report

Photometric Filename:ICDLR16015WCCT-WH 3K.IES

Indoor Luminance Limiting Curves

Lum. Name: ICDLR16015WCCT-WH	Lum. Catalog: LED DOWNLIGHT	Test ID:
Lamp Name: 3000K	Lamp Catalog: SMD2835	Test Lab:
Manufacture:	Test Machine:GON-2000	Test Date: 2020/05/31

Glare Grade Table

GI	Quality	Using Illuminance							
		a	b	c	d	e	f	g	h
1.15	A	2000	1000	500	<=300				
1.5	B		2000	1000	500	<=300			
1.85	C			2000	1000	500	<=300		
2.2	D				2000	1000	500	<=300	
2.55	E	a				2000	1000	500	<=300
			b	c	d	e	f	g	h

Luminance Table

Gama (deg)	45	50	55	60	65	70	75	80	85
C0	14416	13312	12174	11008	9792	8444	6929	4936	2660
C90	12682	11491	10254	8966	7579	6013	4179	1984	0

Luminance Limiting Curve

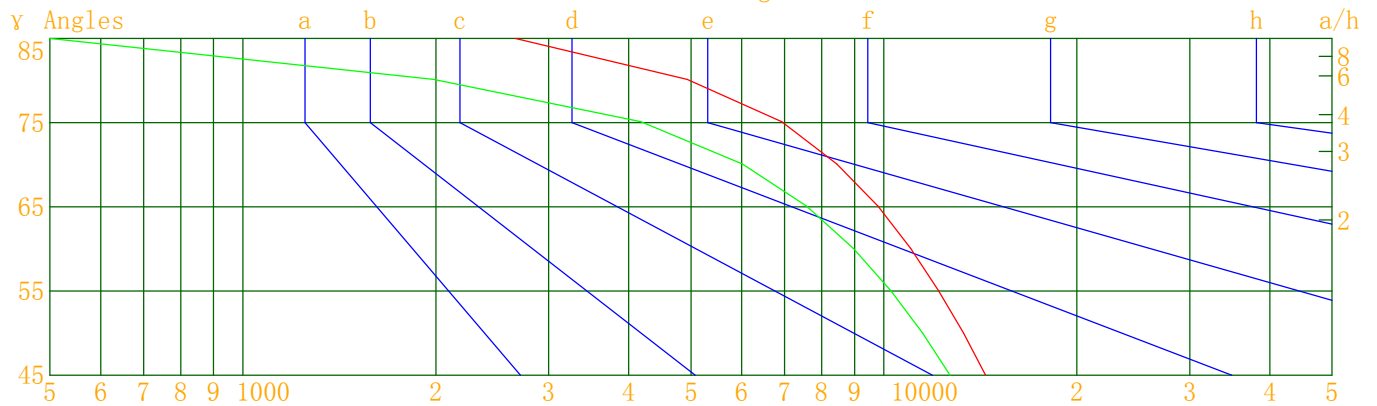

Luminous Size: Length(m)=0.160 Width(m)=0.160 Height(m)=0.046 Area(m²)=0.032960
 Luminous Type: Without Luminous Side
 Luminous Curves: C0-C180 Color: — C90-C270 Color: —

IES Indoor Report

Photometric Filename:ICDLR16015WCCT-WH 3K.IES

Indoor Budgetary Estimate Table

Lum. Name: ICDLR16015WCCT-WH	Lum. Catalog: LED DOWNLIGHT	Test ID:
Lamp Name: 3000K	Lamp Catalog: SMD2835	Test Lab:
Manufacture:	Test Machine:GON-2000	Test Date: 2020/05/31

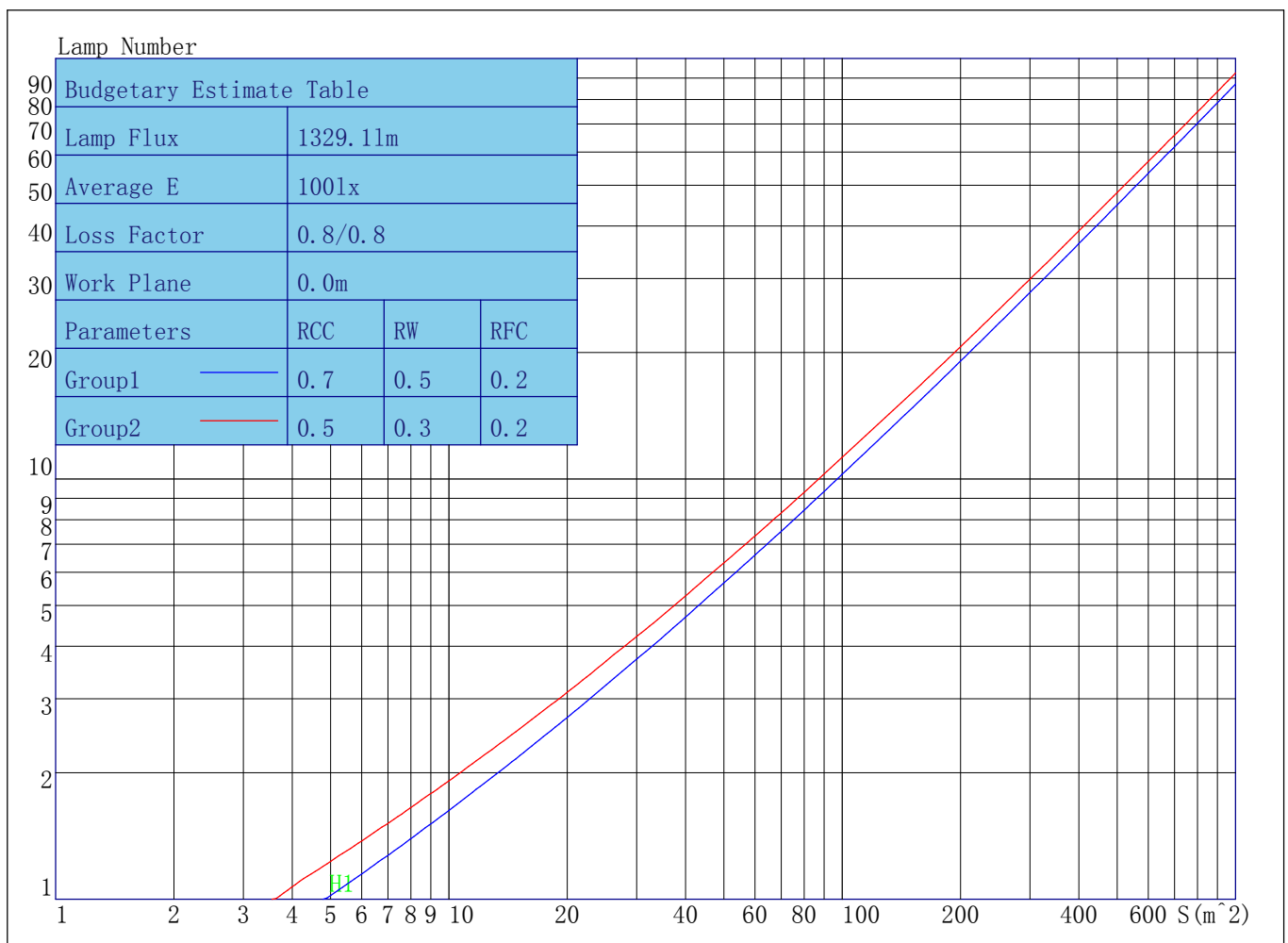

Parameters1: Rhocc = 0.7 Rhow = 0.5 Rhofc = 0.2 LLF = 0.8
 Parameters2: Rhocc = 0.5 Rhow = 0.3 Rhofc = 0.2 LLF = 0.8
 Average Illuminance(lx): 100 Cavity Height: H1(m) = 2

IES Indoor Report

Photometric Filename:ICD0LR16015WCCT-WH 3K.IES

Indoor Coefficient of Utilization Table

Lum. Name: ICDLR16015WCCT-WH	Lum. Catalog: LED DOWNLIGHT	Test ID:
Lamp Name: 3000K	Lamp Catalog: SMD2835	Test Lab:
Manufacture:	Test Machine:GON-2000	Test Date: 2020/05/31

Coefficients of Utilization - Zonal Cavity Method																		
Coef.	Effective Floor Cavity Reflectance RFC=0.20																	
RhoCC (%)	80				70				50			30			10			0
RhoW (%)	70	50	30	10	70	50	30	10	50	30	10	50	30	10	50	30	10	0
RCR	Coefficient of Utilization(%)																	
0	119	119	119	119	116	116	116	116	111	111	111	106	106	106	102	102	102	100
1	110	106	103	99	108	104	101	98	100	97	94	96	94	92	92	91	89	87
2	101	94	88	83	99	92	87	82	89	84	80	86	82	78	83	79	77	75
3	93	84	76	71	91	82	75	70	79	74	69	77	72	68	74	70	66	64
4	86	75	67	61	84	74	66	60	71	65	60	69	63	59	67	62	58	56
5	80	68	59	53	78	67	59	53	65	58	52	63	57	52	61	56	51	49
6	74	61	53	47	72	60	53	47	59	52	46	57	51	46	56	50	46	44
7	69	56	48	42	67	55	47	42	54	47	42	52	46	41	51	45	41	39
8	64	51	43	38	63	51	43	38	49	42	37	48	42	37	47	41	37	35
9	60	47	40	34	59	47	39	34	46	39	34	45	38	34	44	38	34	32
10	56	44	36	31	55	43	36	31	42	36	31	41	35	31	41	35	31	29

IES Indoor Report

Photometric Filename:ICDLR16015WCCT-WH 3K.IES

Unified Glare Rating Table

Lum. Name: ICDLR16015WCCT-WH	Lum. Catalog: LED DOWNLIGHT	Test ID:
Lamp Name: 3000K	Lamp Catalog: SMD2835	Test Lab:
Manufacture:	Test Machine:GON-2000	Test Date: 2020/05/31

Unified Glare Rating Table

Ceiling RCC	0.70	0.70	0.50	0.50	0.30	0.70	0.70	0.50	0.50	0.30	
Wall RW	0.50	0.30	0.50	0.30	0.30	0.50	0.30	0.50	0.30	0.30	
Floor RFC	0.20	0.20	0.20	0.20	0.20	0.20	0.20	0.20	0.20	0.20	
Room Size	Vewed crosswise					Vewed endwise					
X=2H	Y=2H	32.5	35.8	33.2	36.4	37.0	31.5	34.8	32.2	35.4	36.0
	Y=3H	35.7	39.0	36.4	39.6	40.2	34.0	37.3	34.8	37.9	38.5
	Y=4H	37.7	40.5	38.4	41.1	41.7	35.6	38.4	36.4	39.0	39.6
	Y=6H	38.5	41.2	39.2	41.8	42.4	36.0	38.7	36.7	39.3	39.9
	Y=8H	38.7	41.4	39.4	42.0	42.6	36.0	38.7	36.7	39.3	39.9
	Y=12H	38.7	41.4	39.5	42.0	42.6	35.9	38.6	36.7	39.2	39.8
X=4H	Y=2H	33.5	36.2	34.2	36.8	37.4	32.7	35.5	33.5	36.1	36.7
	Y=3H	36.8	39.6	37.5	40.2	40.8	35.4	38.2	36.2	38.8	39.4
	Y=4H	37.2	38.7	38.2	39.6	40.4	35.5	37.0	36.4	37.8	38.6
	Y=6H	38.3	39.7	39.3	40.5	41.3	36.1	37.4	37.0	38.3	39.1
	Y=8H	38.6	39.9	39.6	40.8	41.5	36.2	37.5	37.1	38.3	39.1
	Y=12H	37.9	38.9	38.9	39.9	40.7	35.2	36.3	36.3	37.3	38.1
X=8H	Y=4H	37.3	38.6	38.3	39.5	40.3	35.7	37.0	36.6	37.8	38.6
	Y=6H	37.7	38.5	38.7	39.5	40.4	35.5	36.4	36.6	37.4	38.2
	Y=8H	37.5	38.2	38.6	39.2	40.2	35.2	35.8	36.3	36.9	37.8
	Y=12H	37.7	38.3	38.8	39.4	40.3	35.2	35.8	36.3	36.9	37.8
X=12H	Y=4H	36.4	37.5	37.5	38.4	39.3	34.8	35.8	35.8	36.8	37.6
	Y=6H	37.1	37.8	38.2	38.9	39.8	35.0	35.7	36.1	36.8	37.7
	Y=8H	37.5	38.1	38.6	39.2	40.1	35.1	35.8	36.3	36.8	37.8
Variations with the objver position at spacings											
	S=1.0H	3.1/-1.4					3.3/-0.7				
	S=1.5H	-1.4/-21.7					-0.4/-19.9				
	S=2.0H	-1.4/-21.7					-0.4/-19.9				

IES Indoor Report

Photometric Filename:ICD0LR16015WCCT-WH 3K.IES

Candela Tabulation

V/H	C0.0	C90.0	C180.0	C270.0
Υ 0.0	619.95	619.95	619.95	619.95
Υ 5.0	620.59	608.36	614.84	613.72
Υ 10.0	610.96	592.98	598.98	603.70
Υ 15.0	592.97	569.77	574.86	585.42
Υ 20.0	566.63	538.71	543.19	558.98
Υ 25.0	532.67	500.16	503.39	525.11
Υ 30.0	490.82	453.66	456.55	482.83
Υ 35.0	442.46	403.03	404.19	434.30
Υ 40.0	389.93	349.28	349.53	382.10
Υ 45.0	335.97	295.57	294.45	328.12
Υ 50.0	282.04	243.45	241.26	274.41
Υ 55.0	230.15	193.86	191.10	222.99
Υ 60.0	181.41	147.77	144.82	174.84
Υ 65.0	136.39	105.57	102.69	130.46
Υ 70.0	95.19	67.78	65.24	90.20
Υ 75.0	59.11	35.65	33.59	54.72
Υ 80.0	28.25	11.35	10.14	25.55
Υ 85.0	7.64	0.00	0.00	6.08
Υ 90.0	0.00	0.00	0.00	0.00
Υ 95.0	0.00	0.00	0.00	0.00
Υ 100.0	0.00	0.00	0.00	0.00
Υ 105.0	0.00	0.00	0.00	0.00
Υ 110.0	0.00	0.00	0.00	0.00
Υ 115.0	0.00	0.00	0.00	0.00
Υ 120.0	0.00	0.00	0.00	0.00
Υ 125.0	0.00	0.00	0.00	0.00
Υ 130.0	0.00	0.00	0.00	0.00
Υ 135.0	0.00	0.00	0.00	0.00
Υ 140.0	0.22	0.05	0.32	0.25
Υ 145.0	0.72	0.44	0.79	0.53
Υ 150.0	1.02	0.92	1.15	0.99
Υ 155.0	1.49	1.24	1.63	1.28
Υ 160.0	1.78	1.66	1.96	1.69
Υ 165.0	2.19	1.95	2.30	2.05
Υ 170.0	2.44	2.30	2.65	2.32
Υ 175.0	2.66	2.53	2.83	2.60
Υ 180.0	2.79	2.79	2.79	2.79
