

Indoor Luminaire Photometric Data

Description Information

Lum. Name: ICDLR12WCCT-6K	Lum. Catalog: LED DOWNLIGHT	Test ID:
Lamp Name: 6000K	Lamp Catalog: SMD2835	Test Date: 2019/03/22
Manufacture:	ShldAngle(°):	Test Machine:GON-2000
Test Lab:	Frequency(Hz):	Lamp CCT(K): Ra:
Lum. Size(W*L*H):0.108m*0.108m*0.042m	Lum. Area(m2):0.016	Lum. W(kg): 2.000
Test System: C, γ	Test Step: C=90.0 γ=5.0	Temp.(°C): 25
		Humidity(%):

Character Parameter

Lamp Speciality Parameter		Luminaire Speciality Parameter	
Rated Flux(lm): 1017.170	Luminaire Flux: 1017.167lm	Field Angle(10%Imax): 144.0	
Rated Power(W):	Luminaire Efficiency: 100.00%	Down Lumens&Percent: 1004.792lm 98.78%	
Rated Voltage(V):	Luminaire EER(lm/W): 81.700	Up Lumens&Percent: 12.374lm 1.22%	
Tested Power(W): 12.450	Max. Cand. (cd): 472.791	S/MH: C0_a180=1.138 C90_270=1.137	
Lamps' Inside: 1	Max Cand@Ang. (°): C=0.0 γ=0.0	CIE Type: Semi-Direct	
Tested Electric:U=237.8V, I=0.054A, PF=0.000	Beam Angle(50%Imax): 90.7	ErP Φuse(120°): 863.966lm	
Lamp Size(W*L*H):0.108m*0.108m*0.042m	Left=-44.9 Right=45.8	IRF: 129.032%	

Lighting Distribution Diagram

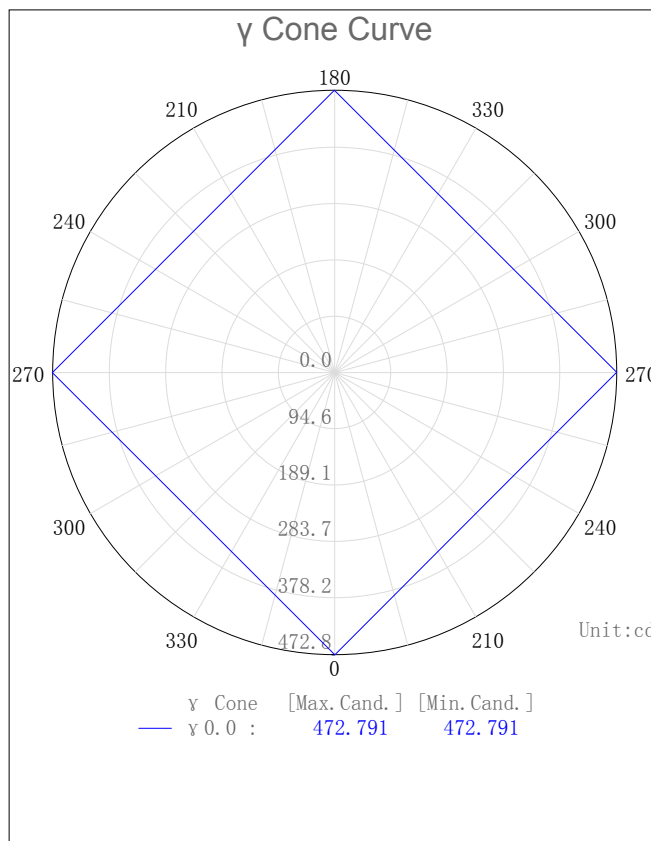
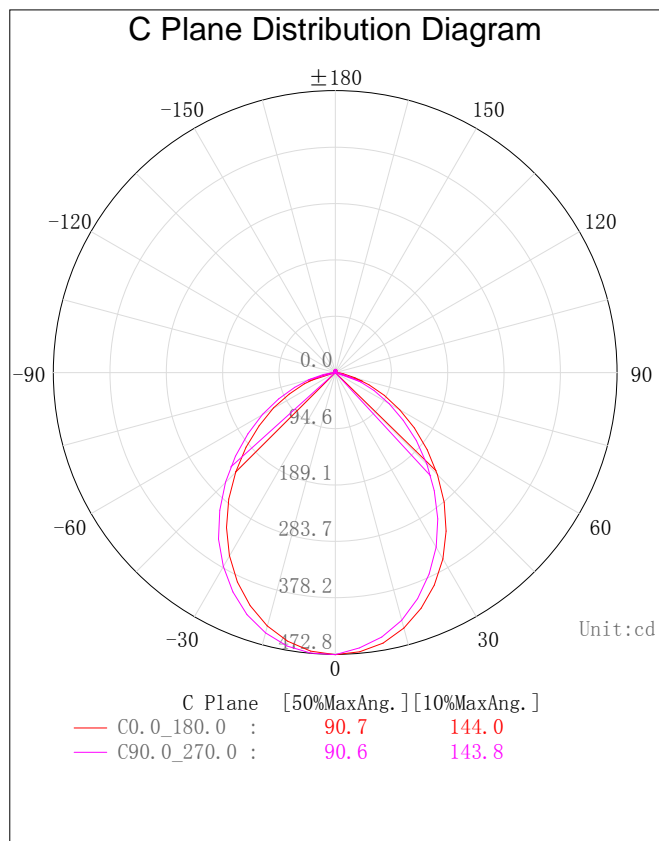

3D Light Intensity Distribution Modal

Lum. Name: ICDLR12WCCT-6K	Lum. Catalog: LED DOWNLIGHT	Test ID:
Lamp Name: 6000K	Lamp Catalog: SMD2835	Test Lab:
Manufacture:	Test Machine:GON-2000	Test Date: 2019/03/22

3D Light Intensity Distribution Modal

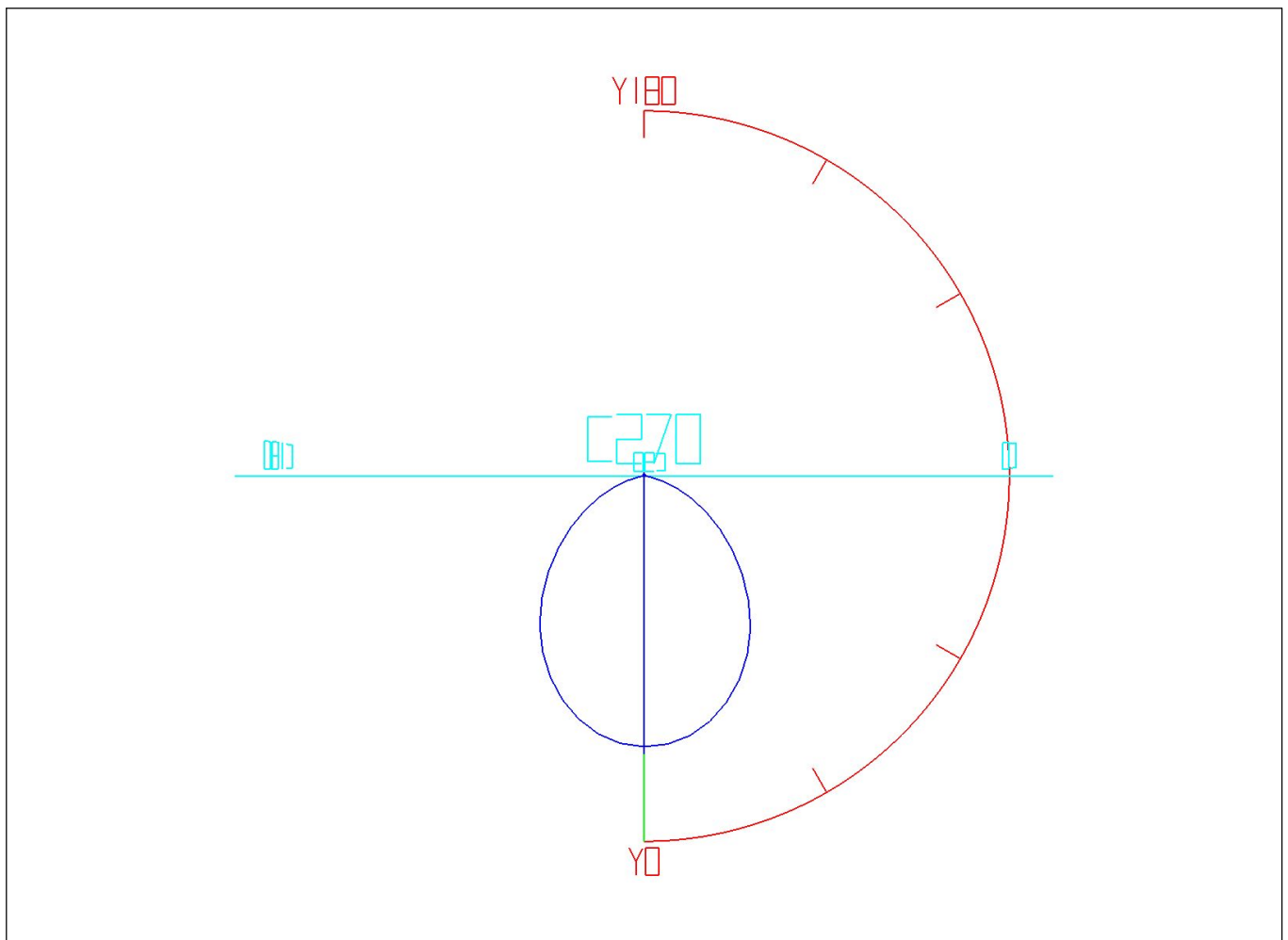

Curves: 3D Model — 3D Model — Fixture — Fixture — Vert. HUD — Vert. HUD — Hori. HUD — Hori. HUD —
View Angles: Orient:0 Tilt:0 Roll:0 Spin:0

IES Indoor Report

Photometric Filename:ICDLR12WCCT-6K.IES

Zonal Flux Tabulation

Zone (y)	Zone Flux (lm)	Sums Flux (lm)	Zone%Lamp	Sums%Lamp
0.0-5.0	11.26	11.26	1.11	1.11
5.0-10.0	33.18	44.43	3.26	4.37
10.0-15.0	53.38	97.82	5.25	9.62
15.0-20.0	70.84	168.65	6.96	16.58
20.0-25.0	84.75	253.40	8.33	24.91
25.0-30.0	94.54	347.94	9.29	34.21
30.0-35.0	99.80	447.74	9.81	44.02
35.0-40.0	100.27	548.01	9.86	53.88
40.0-45.0	96.17	644.18	9.45	63.33
45.0-50.0	88.34	732.52	8.68	72.02
50.0-55.0	77.66	810.18	7.64	79.65
55.0-60.0	64.99	875.18	6.39	86.04
60.0-65.0	51.15	926.32	5.03	91.07
65.0-70.0	37.03	963.35	3.64	94.71
70.0-75.0	23.54	986.90	2.31	97.02
75.0-80.0	12.02	998.91	1.18	98.21
80.0-85.0	4.58	1003.49	0.45	98.66
85.0-90.0	1.30	1004.79	0.13	98.78
90.0-95.0	0.33	1005.12	0.03	98.82
95.0-100.0	0.28	1005.40	0.03	98.84
100.0-105.0	0.35	1005.76	0.03	98.88
105.0-110.0	0.48	1006.23	0.05	98.92
110.0-115.0	0.61	1006.85	0.06	98.99
115.0-120.0	0.74	1007.59	0.07	99.06
120.0-125.0	0.86	1008.45	0.08	99.14
125.0-130.0	0.96	1009.41	0.09	99.24
130.0-135.0	1.03	1010.44	0.10	99.34
135.0-140.0	1.07	1011.50	0.10	99.44
140.0-145.0	1.07	1012.57	0.11	99.55
145.0-150.0	1.03	1013.60	0.10	99.65
150.0-155.0	0.96	1014.57	0.09	99.74
155.0-160.0	0.86	1015.43	0.08	99.83
160.0-165.0	0.72	1016.15	0.07	99.90
165.0-170.0	0.55	1016.70	0.05	99.95
170.0-175.0	0.35	1017.05	0.03	99.99
175.0-180.0	0.12	1017.17	0.01	100.00

Rectangle ISO Lighting Intensity Diagram

Lum. Name: ICDLR12WCCT-6K	Lum. Catalog: LED DOWNLIGHT	Test ID:
Lamp Name: 6000K	Lamp Catalog: SMD2835	Test Lab:
Manufacture:	Test Machine:GON-2000	Test Date: 2019/03/22

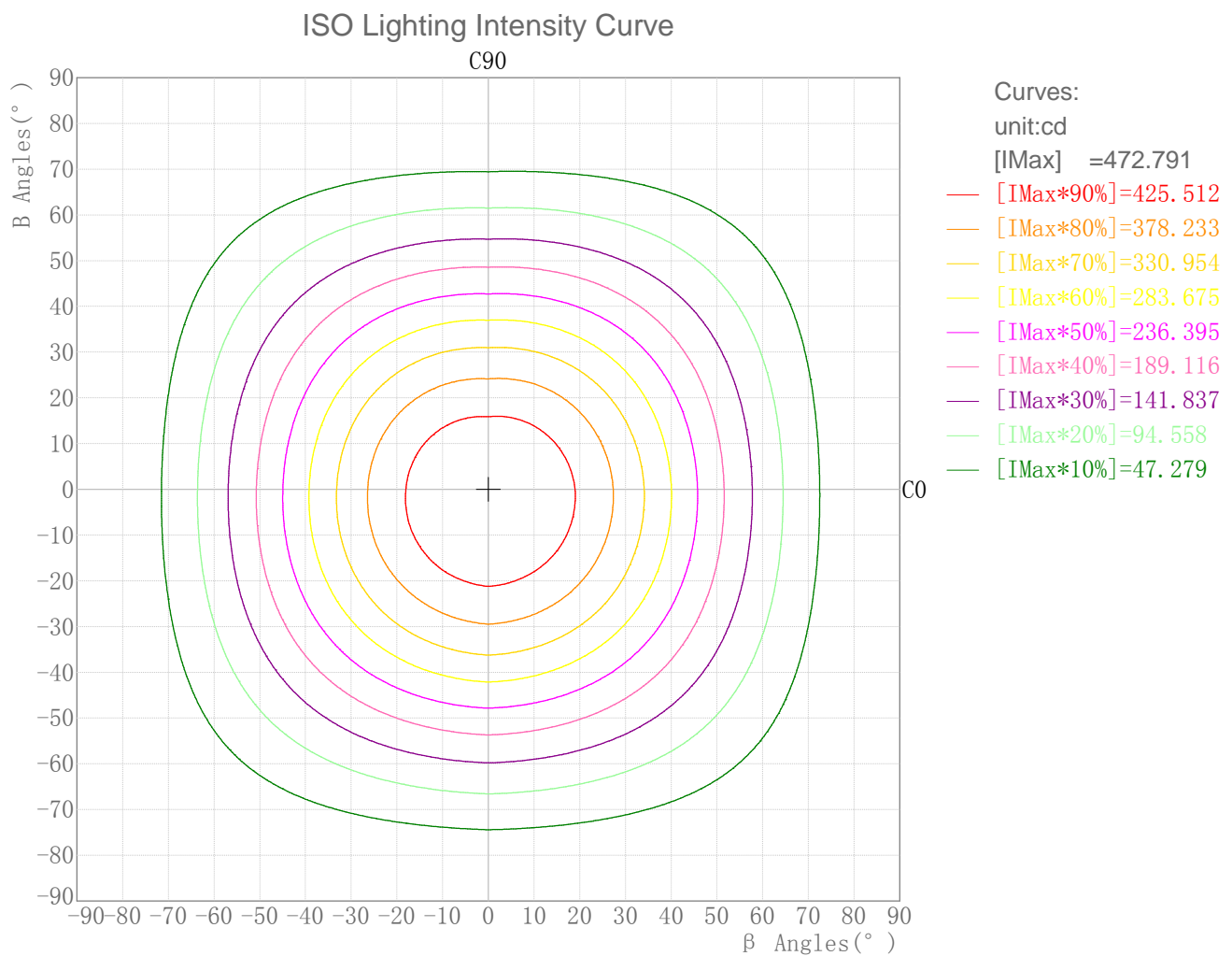

Maximum Light Intensity(cd): 472.79
Maximum Cand.@Angle: H=0.0°,V=0.0°

Plane ISO-Illuminance Diagram

Lum. Name: ICDLR12WCCT-6K	Lum. Catalog: LED DOWNLIGHT	Test ID:
Lamp Name: 6000K	Lamp Catalog: SMD2835	Test Lab:
Manufacture:	Test Machine:GON-2000	Test Date: 2019/03/22

Plane ISO-Illuminance Curve

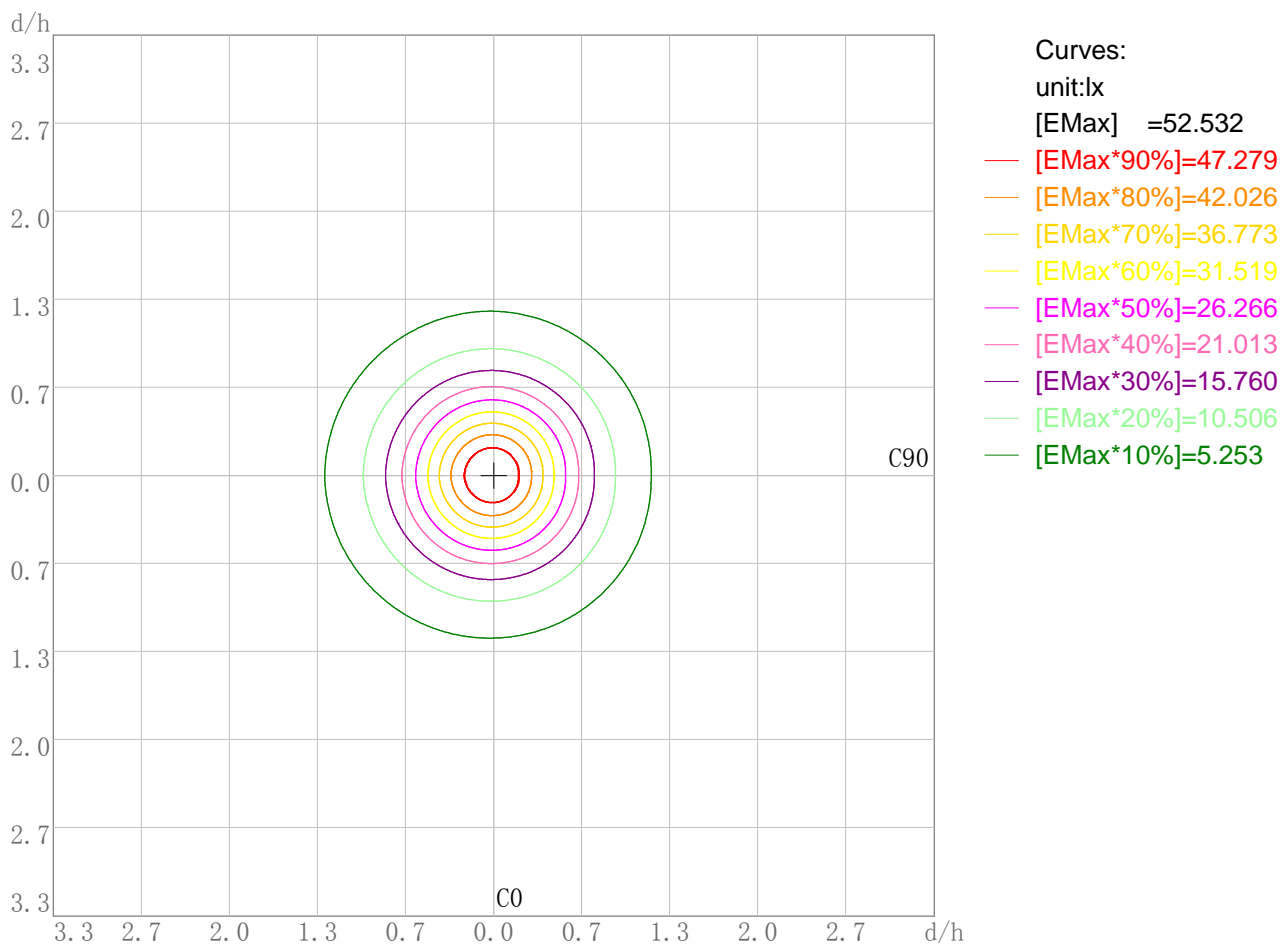

Working Plane Luminaire Mounting Height(m): 3.00
 Working Plane Maximum Illuminance(lx): 52.53
 Working Plane Maximum Illuminance Position(d/h):H0.0 V0.0

3D Plane ISO Illuminance Diagram

Lum. Name: ICDLR12WCCT-6K	Lum. Catalog: LED DOWNLIGHT	Test ID:
Lamp Name: 6000K	Lamp Catalog: SMD2835	Test Lab:
Manufacture:	Test Machine:GON-2000	Test Date: 2019/03/22

3D Plane Illuminance Modal

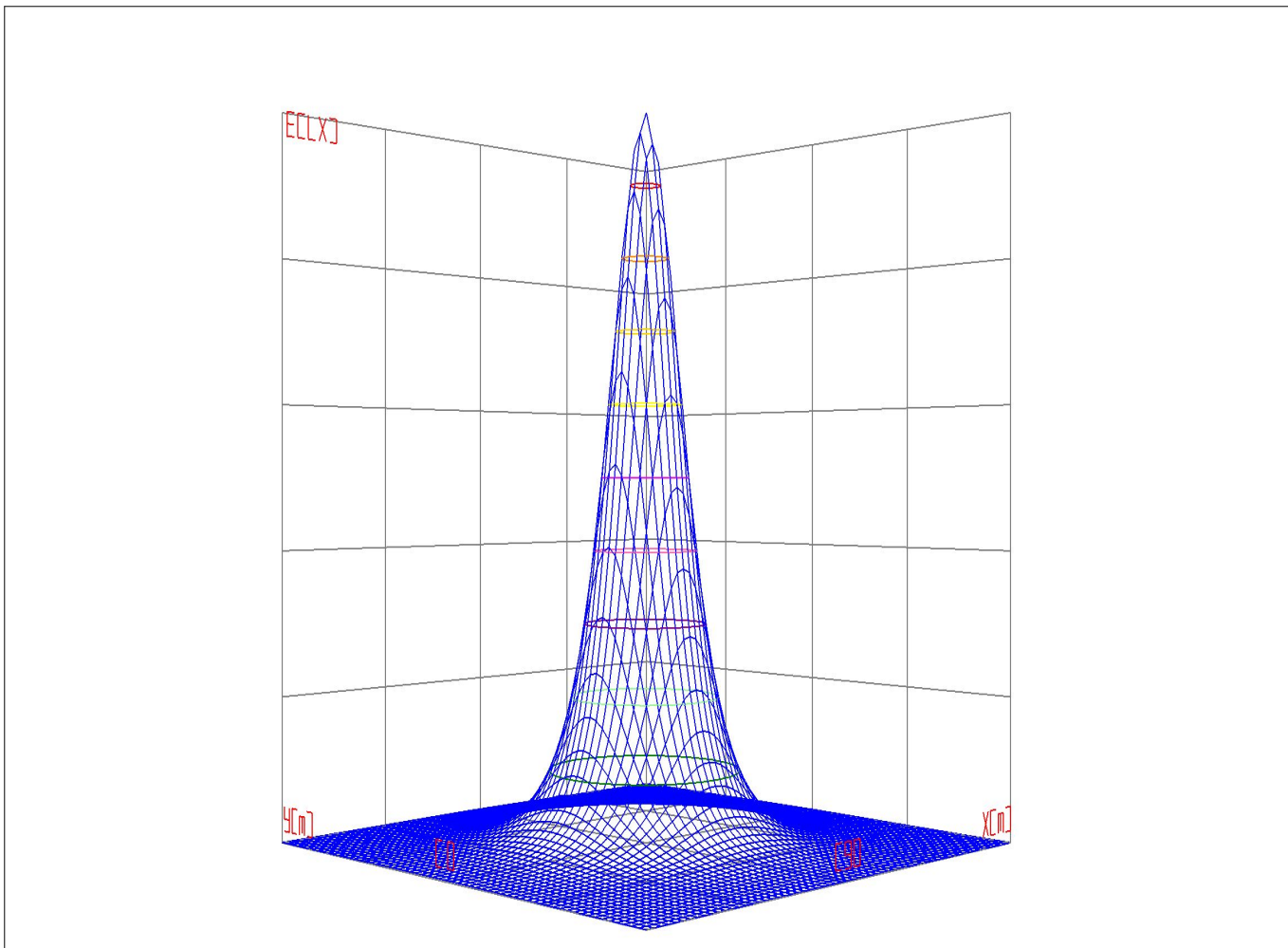

Curves: 3D Model — 90% — 80% — 70% — 60% — 50% — 40% — 30% — 20% — 10% —
View Angles(deg): 0 Height(m): 3.0 Distance(m): 10.0

Space ISO Illuminance Diagram

Lum. Name: ICDLR12WCCT-6K	Lum. Catalog: LED DOWNLIGHT	Test ID:
Lamp Name: 6000K	Lamp Catalog: SMD2835	Test Lab:
Manufacture:	Test Machine:GON-2000	Test Date: 2019/03/22

Space ISO Illuminance Curve

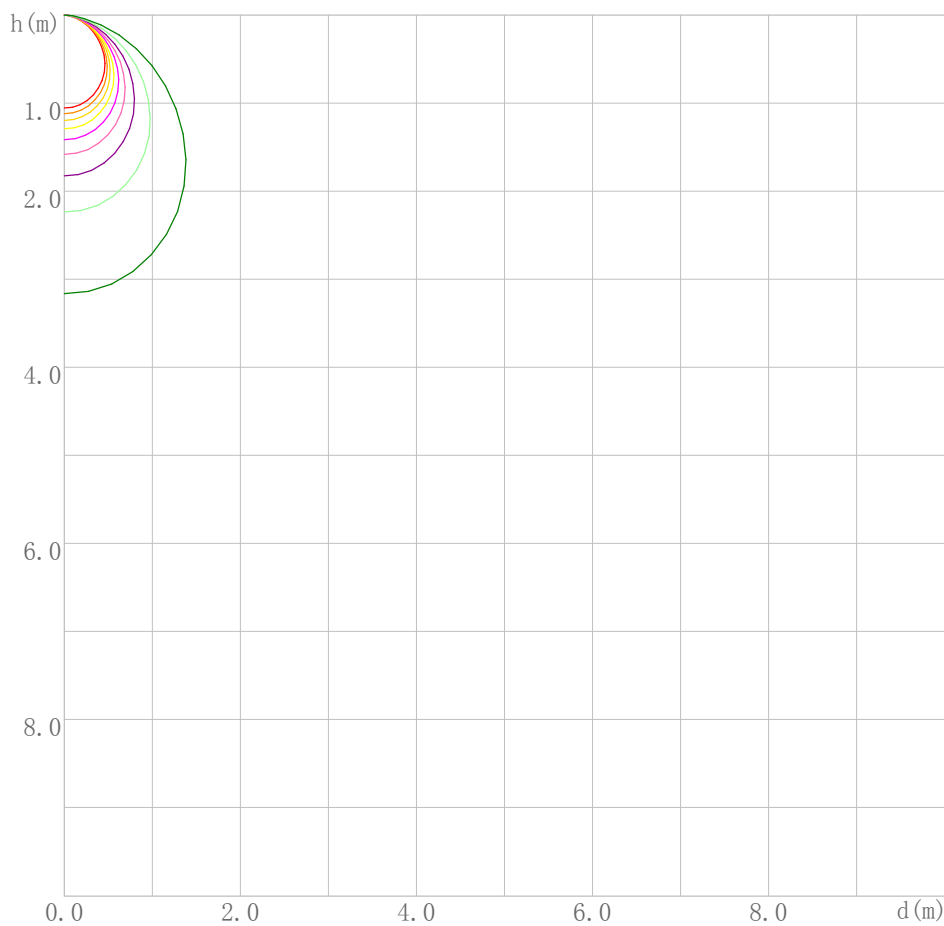

- Curves:
unit:lx
[EMax] =472.791
- [EMax*90%]=425.512
 - [EMax*80%]=378.233
 - [EMax*70%]=330.954
 - [EMax*60%]=283.675
 - [EMax*50%]=236.395
 - [EMax*40%]=189.116
 - [EMax*30%]=141.837
 - [EMax*20%]=94.558
 - [EMax*10%]=47.279

Space Plane Maximum Illuminance and @Angle:472.79,0.0deg
Plane Maximum Lighting Intensity and @Angle:472.791cd,0deg

Illuminance-Distance Diagram

Lum. Name: ICDLR12WCCT-6K	Lum. Catalog: LED DOWNLIGHT	Test ID:
Lamp Name: 6000K	Lamp Catalog: SMD2835	Test Lab:
Manufacture:	Test Machine:GON-2000	Test Date: 2019/03/22

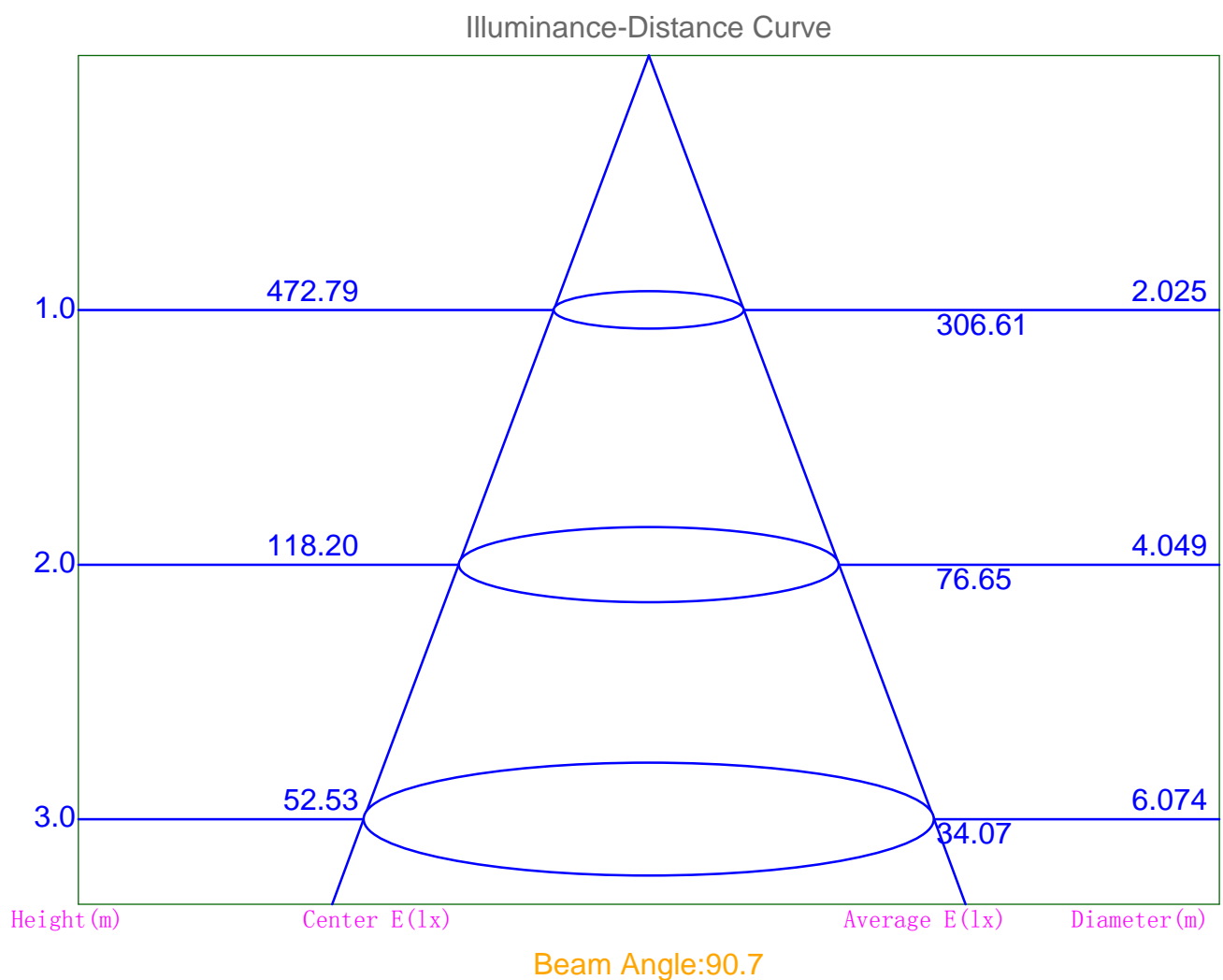

Indoor Luminance Limiting Curves

Lum. Name: ICDLR12WCCT-6K	Lum. Catalog: LED DOWNLIGHT	Test ID:
Lamp Name: 6000K	Lamp Catalog: SMD2835	Test Lab:
Manufacture:	Test Machine:GON-2000	Test Date: 2019/03/22

Glare Grade Table

GI	Quality	Using Illuminance							
		a	b	c	d	e	f	g	h
1.15	A	2000	1000	500	<=300				
1.5	B		2000	1000	500	<=300			
1.85	C			2000	1000	500	<=300		
2.2	D				2000	1000	500	<=300	
2.55	E	a				2000	1000	500	<=300
			b	c	d	e	f	g	h

Luminance Table

Gama (deg)	45	50	55	60	65	70	75	80	85
C0	21182	19364	17454	15444	13289	10909	8135	5089	3837
C90	19001	17047	15011	12856	10537	7955	5014	2127	393

Luminance Limiting Curve

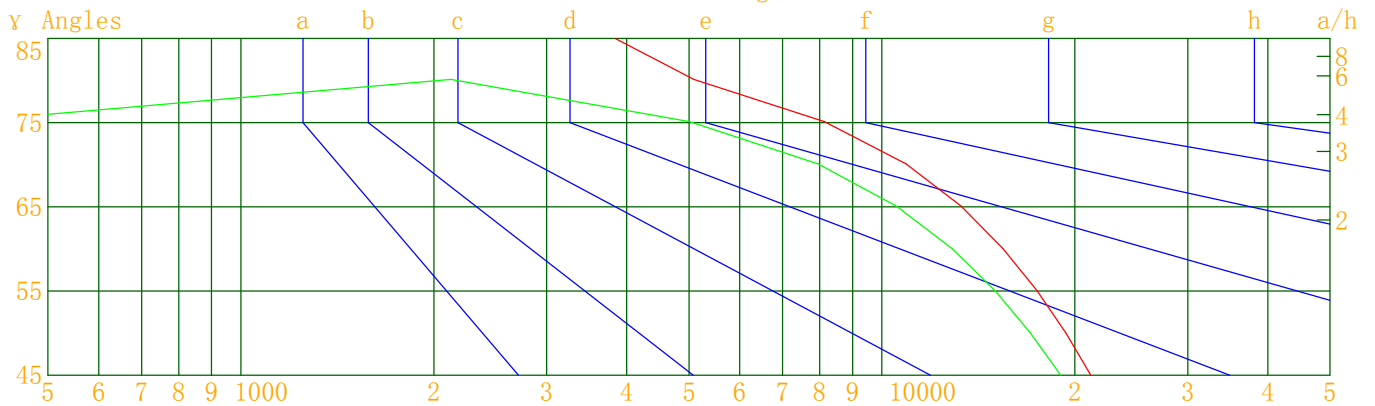

Luminous Size: Length(m)=0.108 Width(m)=0.108 Height(m)=0.042 Area(m^2)=0.016200
 Luminous Type: Without Luminous Side
 Luminous Curves: C0-C180 Color: — C90-C270 Color: —

Indoor Budgetary Estimate Table

Lum. Name: ICDLR12WCCT-6K	Lum. Catalog: LED DOWNLIGHT	Test ID:
Lamp Name: 6000K	Lamp Catalog: SMD2835	Test Lab:
Manufacture:	Test Machine:GON-2000	Test Date: 2019/03/22

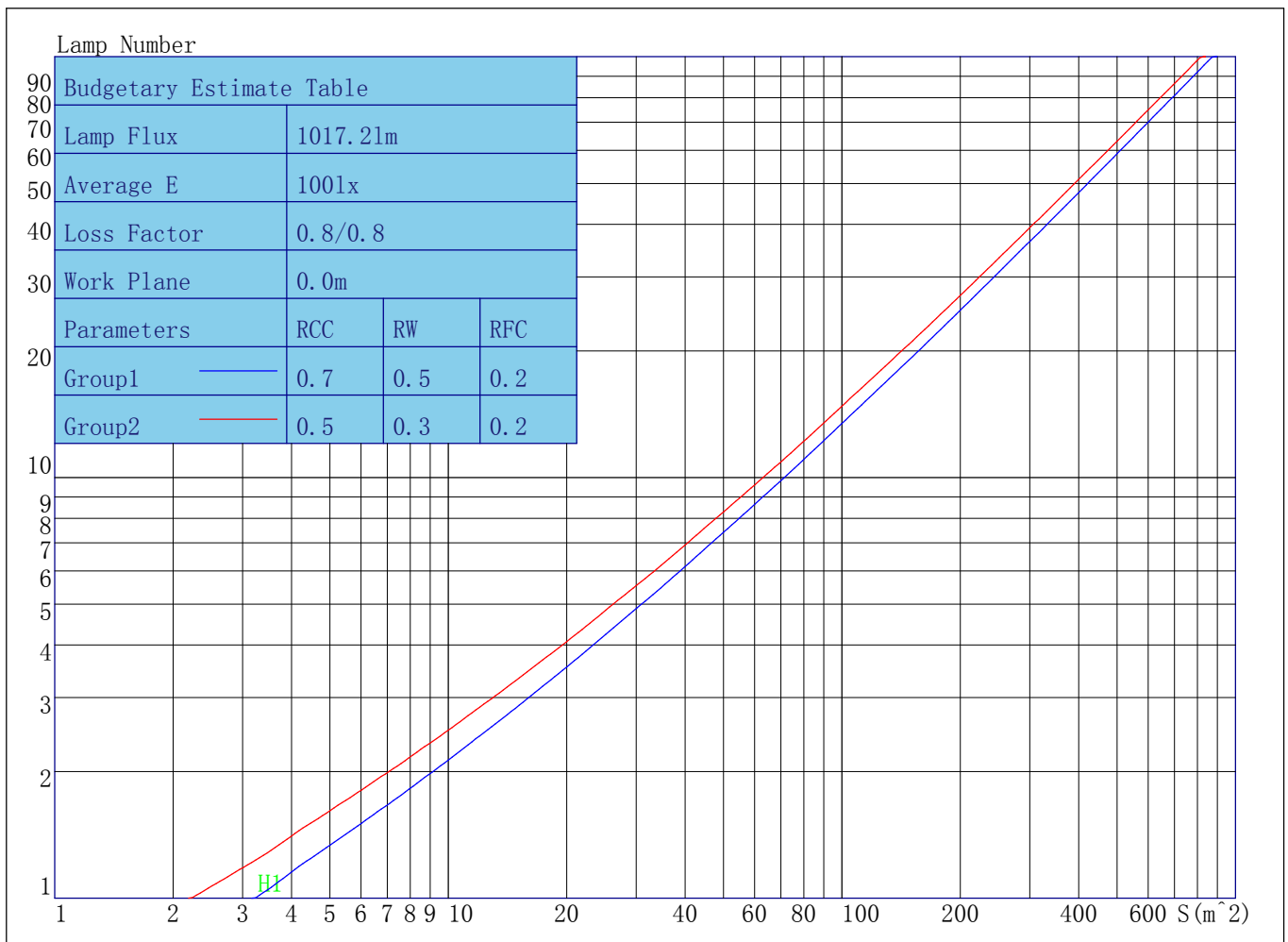

Parameters1: Rhocc = 0.7 Rhow = 0.5 Rhofc = 0.2 LLF = 0.8
 Parameters2: Rhocc = 0.5 Rhow = 0.3 Rhofc = 0.2 LLF = 0.8
 Average Illuminance(lx): 100 Cavity Height: H1(m) = 2

Indoor Coefficient of Utilization Table

Lum. Name: ICDLR12WCCT-6K	Lum. Catalog: LED DOWNLIGHT	Test ID:
Lamp Name: 6000K	Lamp Catalog: SMD2835	Test Lab:
Manufacture:	Test Machine:GON-2000	Test Date: 2019/03/22

Coefficients of Utilization - Zonal Cavity Method																		
Coef.	Effective Floor Cavity Reflectance RFC=0.20																	
RhoCC (%)	80				70				50			30			10			0
RhoW (%)	70	50	30	10	70	50	30	10	50	30	10	50	30	10	50	30	10	0
RCR	Coefficient of Utilization(%)																	
0	119	119	119	119	116	116	116	116	110	110	110	105	105	105	101	101	101	99
1	110	106	102	99	107	104	100	97	99	97	94	95	93	91	91	90	88	86
2	101	94	88	83	99	92	87	82	88	84	80	85	81	78	82	79	76	74
3	93	84	76	71	91	82	75	70	79	73	68	76	71	67	74	69	66	64
4	86	75	67	61	84	74	66	60	71	65	59	69	63	59	66	62	58	56
5	79	68	59	53	77	66	59	53	64	57	52	62	56	52	60	55	51	49
6	74	61	53	47	72	60	52	47	58	52	46	57	51	46	55	50	45	43
7	69	56	48	42	67	55	47	42	53	47	41	52	46	41	51	45	41	39
8	64	51	43	38	62	51	43	38	49	42	37	48	42	37	47	41	37	35
9	60	47	40	34	59	47	39	34	45	39	34	44	38	34	43	38	33	32
10	56	44	36	31	55	43	36	31	42	36	31	41	35	31	40	35	31	29

Unified Glare Rating Table

Lum. Name: ICDLR12WCCT-6K	Lum. Catalog: LED DOWNLIGHT	Test ID:
Lamp Name: 6000K	Lamp Catalog: SMD2835	Test Lab:
Manufacture:	Test Machine:GON-2000	Test Date: 2019/03/22

Unified Glare Rating Table

Ceiling RCC	0.70	0.70	0.50	0.50	0.30	0.70	0.70	0.50	0.50	0.30
Wall RW	0.50	0.30	0.50	0.30	0.30	0.50	0.30	0.50	0.30	0.30
Floor RFC	0.20	0.20	0.20	0.20	0.20	0.20	0.20	0.20	0.20	0.20
Room Size	Vewed crosswise					Vewed endwise				
X=2H Y=2H	36.8	40.1	37.6	40.8	41.4	36.0	39.2	36.8	39.9	40.5
Y=3H	39.6	42.8	40.4	43.5	44.1	38.2	41.4	38.9	42.1	42.7
Y=4H	41.3	44.0	42.1	44.7	45.3	39.5	42.2	40.3	42.9	43.6
Y=6H	41.8	44.4	42.6	45.1	45.8	39.7	42.4	40.5	43.1	43.7
Y=8H	41.9	44.5	42.7	45.2	45.9	39.7	42.3	40.5	43.0	43.7
Y=12H	41.9	44.5	42.7	45.2	45.9	39.7	42.3	40.5	43.0	43.6
X=4H Y=2H	37.7	40.4	38.5	41.1	41.7	37.0	39.7	37.8	40.4	41.1
Y=3H	40.6	43.3	41.4	44.0	44.6	39.4	42.1	40.2	42.8	43.4
Y=4H	40.6	42.1	41.6	43.0	43.9	39.1	40.6	40.1	41.5	42.4
Y=6H	41.4	42.7	42.4	43.6	44.5	39.5	40.8	40.5	41.8	42.6
Y=8H	41.6	42.8	42.6	43.8	44.6	39.5	40.8	40.6	41.8	42.6
Y=12H	40.8	41.8	41.9	42.8	43.8	38.6	39.7	39.8	40.7	41.7
X=8H Y=4H	40.7	42.0	41.7	42.9	43.7	39.2	40.5	40.3	41.4	42.3
Y=6H	40.6	41.5	41.8	42.5	43.5	38.9	39.7	40.0	40.8	41.7
Y=8H	40.4	41.0	41.6	42.2	43.2	38.5	39.1	39.7	40.3	41.3
Y=12H	40.5	41.2	41.7	42.3	43.3	38.4	39.1	39.6	40.2	41.2
X=12H Y=4H	39.7	40.8	40.9	41.8	42.8	38.3	39.3	39.4	40.4	41.3
Y=6H	40.1	40.8	41.3	41.9	42.9	38.3	39.0	39.5	40.2	41.2
Y=8H	40.3	41.0	41.5	42.1	43.1	38.4	39.1	39.6	40.2	41.2
Variations with the objver position at spacings										
S=1.0H	3.3/-1.3					3.5/-0.9				
S=1.5H	-1.3/-22.4					-0.4/-20.9				
S=2.0H	-1.3/-22.4					-0.4/-20.9				

IES Indoor Report
Photometric Filename:ICDLR12WCCT-6K.IES

Candela Tabulation

V/H	C0.0	C90.0	C180.0	C270.0
Y 0.0	472.79	472.79	472.79	472.79
Y 5.0	470.23	463.81	468.96	472.38
Y 10.0	460.65	450.42	457.68	465.47
Y 15.0	443.89	430.13	439.77	451.79
Y 20.0	420.82	403.65	416.18	431.83
Y 25.0	393.33	372.93	387.38	406.02
Y 30.0	360.90	338.27	354.21	375.06
Y 35.0	324.40	299.87	317.60	340.69
Y 40.0	284.12	258.75	277.21	301.35
Y 45.0	242.64	217.66	235.92	259.91
Y 50.0	201.64	177.52	194.86	218.53
Y 55.0	162.18	139.48	155.84	178.71
Y 60.0	125.09	104.13	118.99	140.30
Y 65.0	90.98	72.14	85.13	104.79
Y 70.0	60.45	44.08	54.97	72.45
Y 75.0	34.11	21.02	29.27	43.97
Y 80.0	14.31	5.98	10.70	20.27
Y 85.0	5.42	0.56	3.11	7.06
Y 90.0	0.99	0.00	0.00	1.85
Y 95.0	0.94	0.00	0.00	1.02
Y 100.0	0.99	0.07	0.13	1.01
Y 105.0	1.19	0.40	0.39	1.09
Y 110.0	1.39	0.70	0.78	1.35
Y 115.0	1.69	1.12	1.15	1.53
Y 120.0	1.93	1.45	1.51	1.84
Y 125.0	2.31	1.86	1.88	2.10
Y 130.0	2.58	2.23	2.29	2.40
Y 135.0	2.94	2.53	2.63	2.76
Y 140.0	3.21	2.95	3.01	2.99
Y 145.0	3.55	3.23	3.34	3.33
Y 150.0	3.81	3.56	3.67	3.60
Y 155.0	4.11	3.88	3.99	3.87
Y 160.0	4.39	4.12	4.31	4.22
Y 165.0	4.64	4.42	4.57	4.43
Y 170.0	4.85	4.56	4.83	4.69
Y 175.0	5.01	4.77	5.00	4.89
Y 180.0	5.02	5.02	5.02	5.02
