

IES Indoor Report

Photometric Filename:ICDLR12512WCCT-3K.IES

Indoor Luminaire Photometric Data

Description Information

Lum. Name: ICDLR12512WCCT-3K	Lum. Catalog: LED DOWNLIGHT	Test ID:
Lamp Name: 3000K	Lamp Catalog: SMD2835	Test Date: 2019/03/22
Manufacture:	ShldAngle(°):	Test Machine:GON-2000
Test Lab:	Frequency(Hz):	Lamp CCT(K): Ra:
Lum. Size(W*L*H):0.108m*0.108m*0.042m	Lum. Area(m2):0.016	Lum. W(kg): 2.000
Test System: C, γ	Test Step: C=90.0 γ=5.0	Temp.(°C): 25
		Humidity(%):

Character Parameter

Lamp Speciality Parameter		Luminaire Speciality Parameter	
Rated Flux(lm): 962.760	Luminaire Flux: 962.765lm	Field Angle(10%Imax): 143.9	
Rated Power(W):	Luminaire Efficiency: 100.00%	Down Lumens&Percent: 951.160lm 98.79%	
Rated Voltage(V):	Luminaire EER(lm/W): 76.898	Up Lumens&Percent: 11.605lm 1.21%	
Tested Power(W): 12.520	Max. Cand. (cd): 450.736	S/MH: C0_a180=1.138 C90_270=1.127	
Lamps' Inside: 1	Max Cand@Ang. (°): C=0.0 γ=0.0	CIE Type: Semi-Direct	
Tested Electric:U=238.0V, I=0.054A, PF=0.000	Beam Angle(50%Imax): 90.4	ErP Φuse(120°): 818.483lm	
Lamp Size(W*L*H):0.108m*0.108m*0.042m	Left=-44.8 Right=45.6	IRF: 129.773%	

Lighting Distribution Diagram

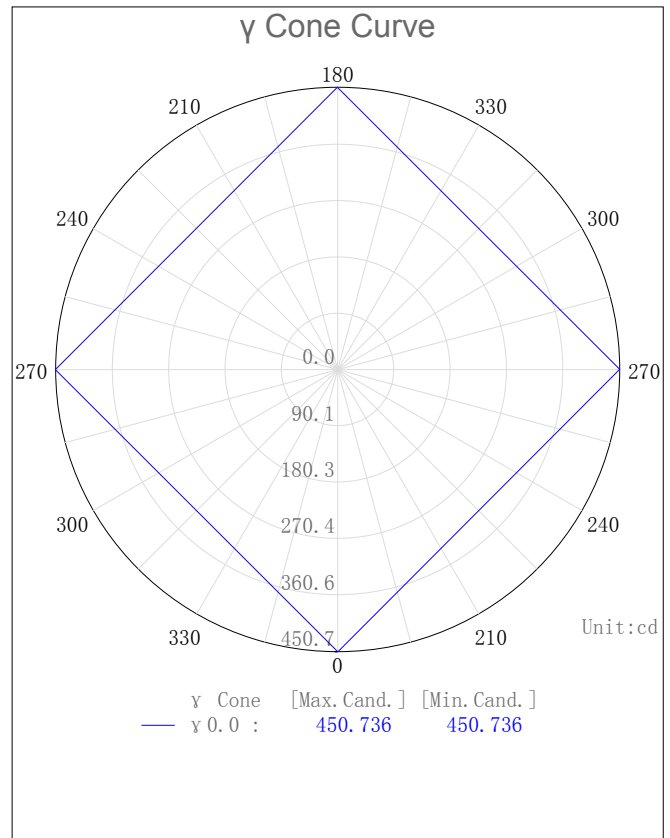
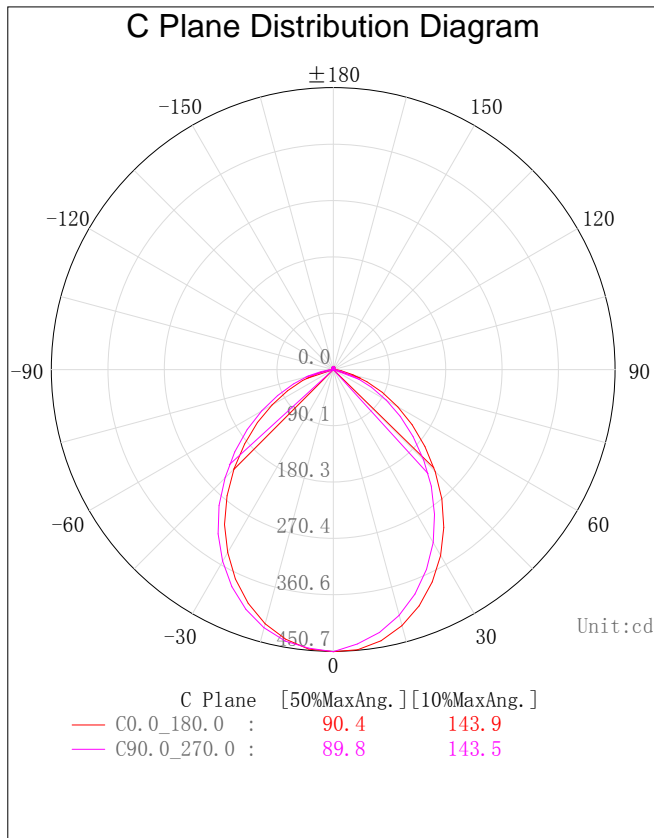

IES Indoor Report

Photometric Filename:ICDLR12512WCCT-3K.IES

3D Light Intensity Distribution Modal

Lum. Name: ICDLR12512WCCT-3K	Lum. Catalog: LED DOWNLIGHT	Test ID:
Lamp Name: 3000K	Lamp Catalog: SMD2835	Test Lab:
Manufacture:	Test Machine:GON-2000	Test Date: 2019/03/22

3D Light Intensity Distribution Modal

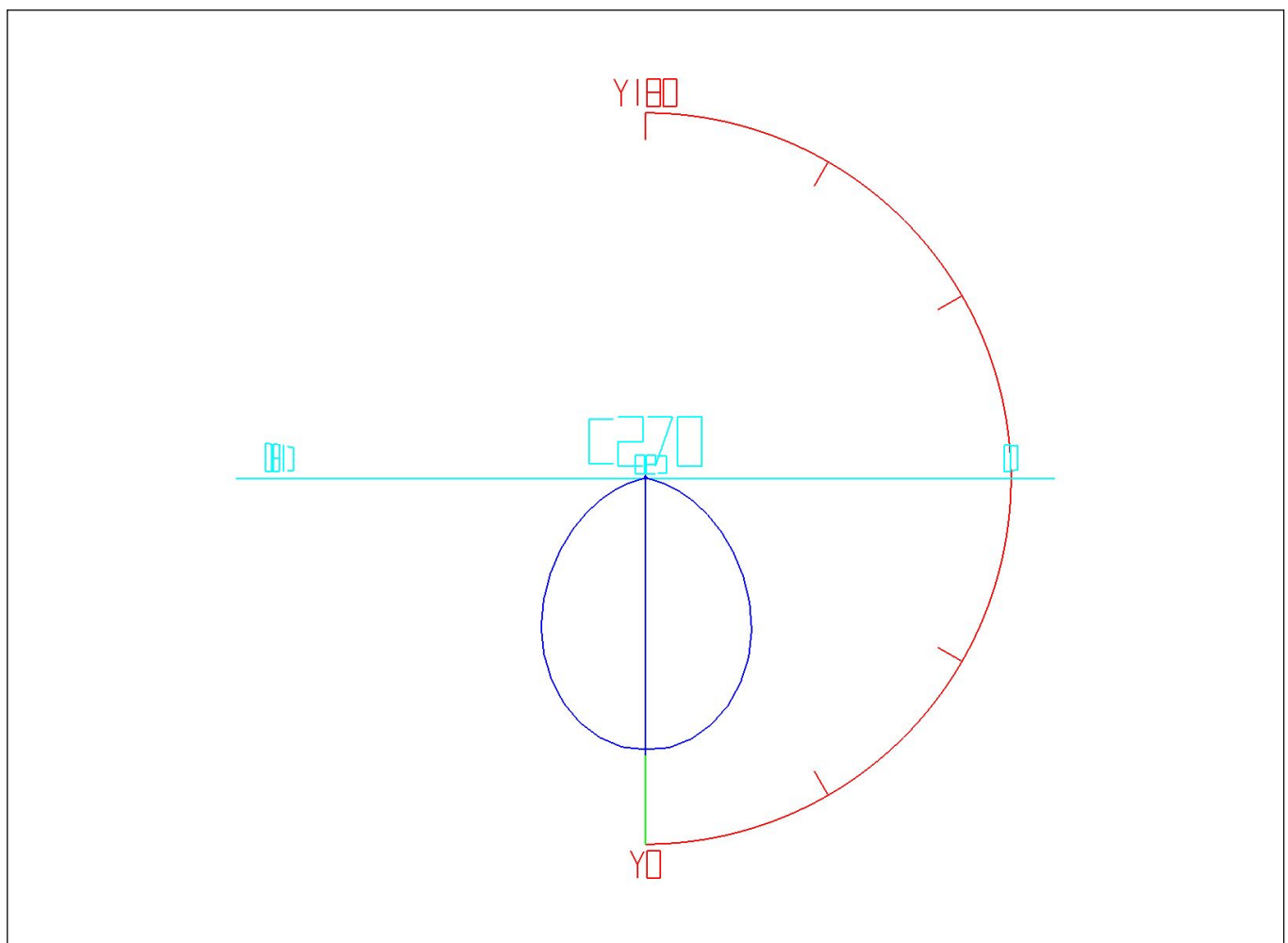

Curves: 3D Model — Fixture — Vert. HUD — Hori. HUD —
View Angles: Orient:0 Tilt:0 Roll:0 Spin:0

IES Indoor Report

Photometric Filename:ICDLR12512WCCT-3K.IES

Zonal Flux Tabulation

Zone (y)	Zone Flux (lm)	Sums Flux (lm)	Zone%Lamp	Sums%Lamp
0.0-5.0	10.73	10.73	1.11	1.11
5.0-10.0	31.58	42.30	3.28	4.39
10.0-15.0	50.77	93.07	5.27	9.67
15.0-20.0	67.34	160.41	6.99	16.66
20.0-25.0	80.49	240.90	8.36	25.02
25.0-30.0	89.67	330.57	9.31	34.34
30.0-35.0	94.56	425.14	9.82	44.16
35.0-40.0	94.89	520.02	9.86	54.01
40.0-45.0	90.91	610.93	9.44	63.46
45.0-50.0	83.43	694.36	8.67	72.12
50.0-55.0	73.29	767.66	7.61	79.74
55.0-60.0	61.31	828.96	6.37	86.10
60.0-65.0	48.24	877.20	5.01	91.11
65.0-70.0	34.90	912.10	3.62	94.74
70.0-75.0	22.16	934.26	2.30	97.04
75.0-80.0	11.32	945.57	1.18	98.22
80.0-85.0	4.34	949.91	0.45	98.67
85.0-90.0	1.25	951.16	0.13	98.80
90.0-95.0	0.34	951.50	0.03	98.83
95.0-100.0	0.27	951.77	0.03	98.86
100.0-105.0	0.33	952.10	0.03	98.89
105.0-110.0	0.45	952.54	0.05	98.94
110.0-115.0	0.57	953.11	0.06	99.00
115.0-120.0	0.69	953.80	0.07	99.07
120.0-125.0	0.80	954.61	0.08	99.15
125.0-130.0	0.90	955.50	0.09	99.25
130.0-135.0	0.96	956.46	0.10	99.35
135.0-140.0	0.99	957.46	0.10	99.45
140.0-145.0	1.00	958.46	0.10	99.55
145.0-150.0	0.97	959.43	0.10	99.65
150.0-155.0	0.91	960.33	0.09	99.75
155.0-160.0	0.81	961.14	0.08	99.83
160.0-165.0	0.68	961.81	0.07	99.90
165.0-170.0	0.52	962.33	0.05	99.96
170.0-175.0	0.32	962.65	0.03	99.99
175.0-180.0	0.11	962.76	0.01	100.00

IES Indoor Report

Photometric Filename:ICDLR12512WCCT-3K.IES

Rectangle ISO Lighting Intensity Diagram

Lum. Name: ICDLR12512WCCT-3K	Lum. Catalog: LED DOWNLIGHT	Test ID:
Lamp Name: 3000K	Lamp Catalog: SMD2835	Test Lab:
Manufacture:	Test Machine:GON-2000	Test Date: 2019/03/22

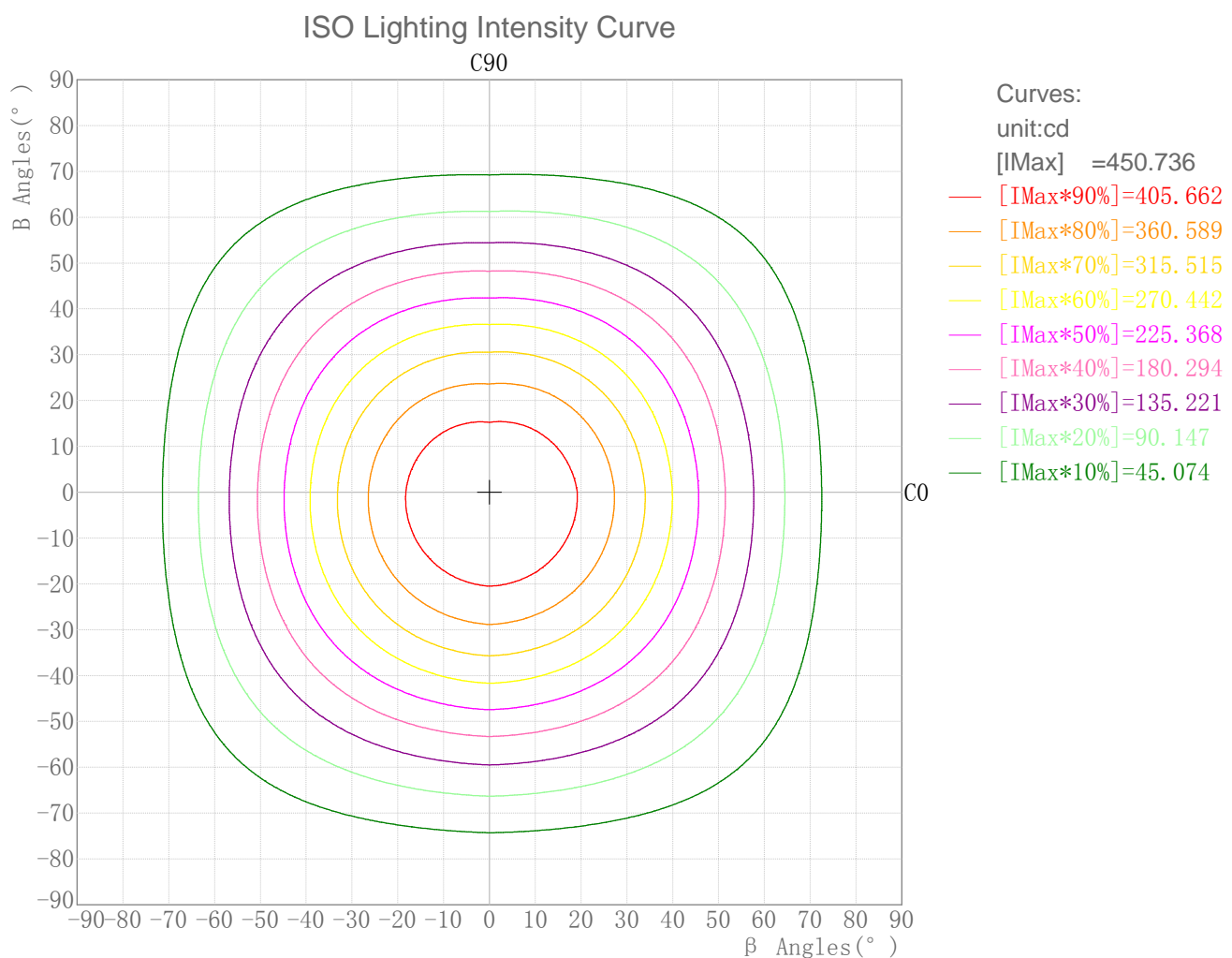

Maximum Light Intensity(cd): 450.74

Maximum Cand.@Angle: H=0.0°,V=0.0°

IES Indoor Report

Photometric Filename:ICDLR12512WCCT-3K.IES

Plane ISO-Illuminance Diagram

Lum. Name: ICDLR12512WCCT-3K	Lum. Catalog: LED DOWNLIGHT	Test ID:
Lamp Name: 3000K	Lamp Catalog: SMD2835	Test Lab:
Manufacture:	Test Machine:GON-2000	Test Date: 2019/03/22

Plane ISO-Illuminance Curve

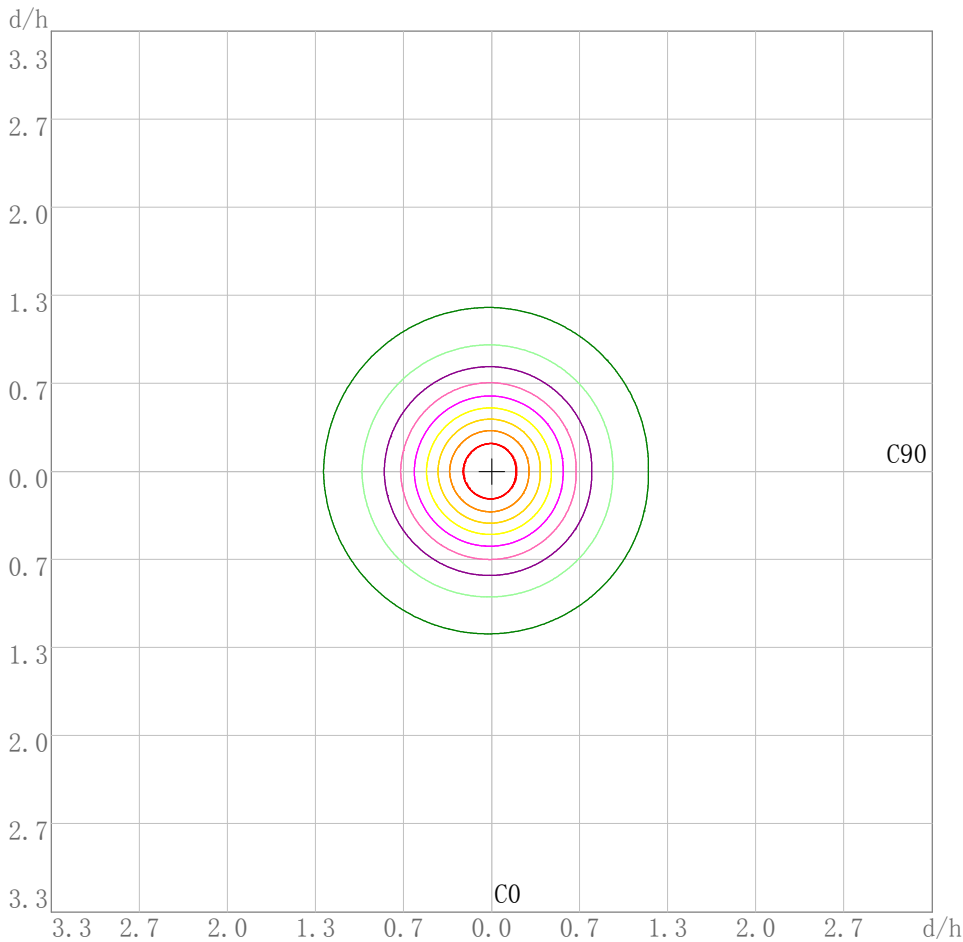

- Curves:
unit:lx
- [EMax] =50.082
 - [EMax*90%]=45.074
 - [EMax*80%]=40.065
 - [EMax*70%]=35.057
 - [EMax*60%]=30.049
 - [EMax*50%]=25.041
 - [EMax*40%]=20.033
 - [EMax*30%]=15.025
 - [EMax*20%]=10.016
 - [EMax*10%]=5.008

Working Plane Luminaire Mounting Height(m): 3.00
 Working Plane Maximum Illuminance(lx): 50.08
 Working Plane Maximum Illuminance Position(d/h):H0.0 V0.0

3D Plane ISO Illuminance Diagram

Lum. Name: ICDLR12512WCCT-3K	Lum. Catalog: LED DOWNLIGHT	Test ID:
Lamp Name: 3000K	Lamp Catalog: SMD2835	Test Lab:
Manufacture:	Test Machine:GON-2000	Test Date: 2019/03/22

3D Plane Illuminance Modal

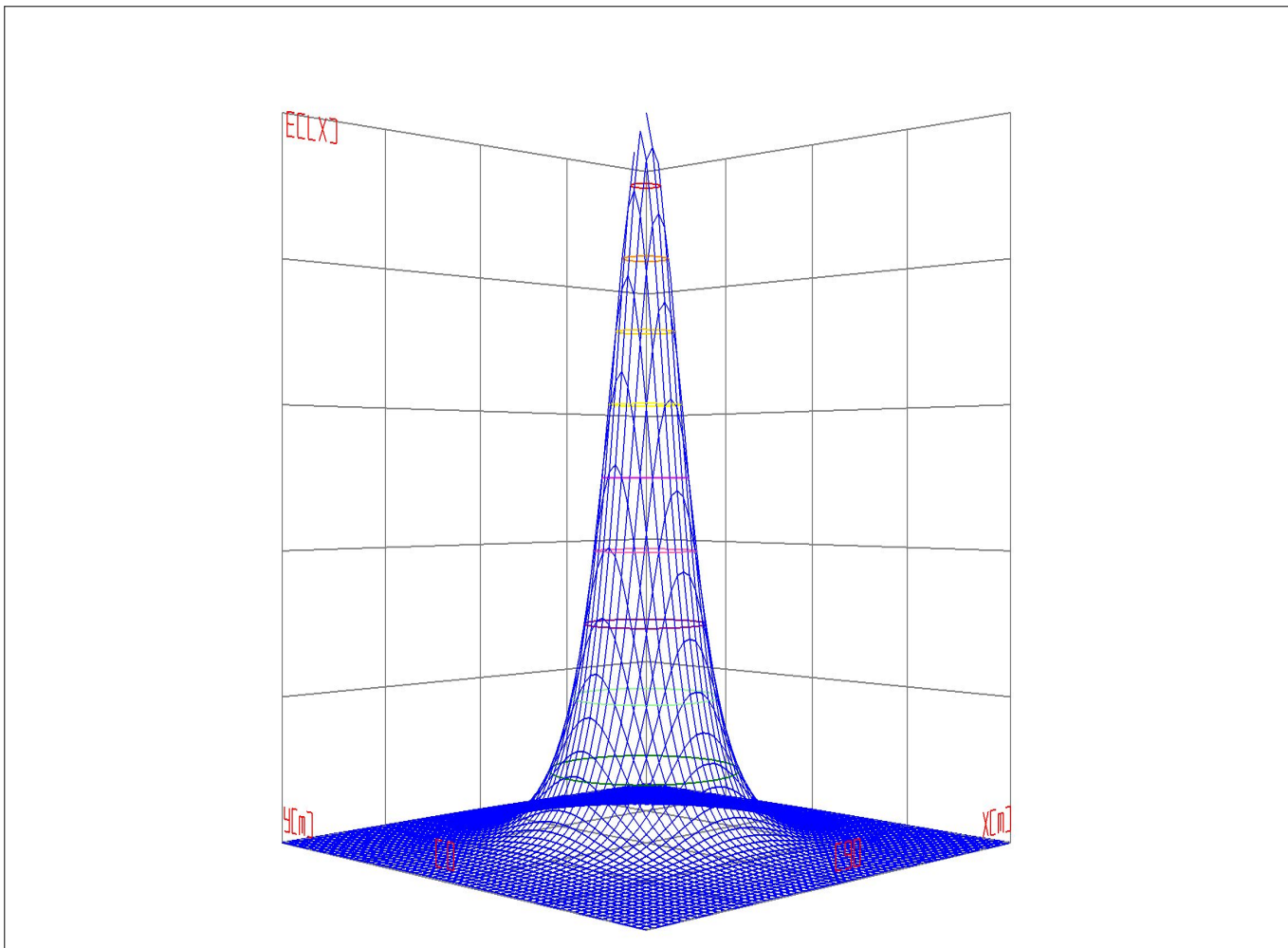

Curves: 3D Model — 90% — 80% — 70% — 60% — 50% — 40% — 30% — 20% — 10% —
View Angles(deg): 0 Height(m): 3.0 Distance(m): 10.0

Space ISO Illuminance Diagram

Lum. Name: ICDLR12512WCCT-3K	Lum. Catalog: LED DOWNLIGHT	Test ID:
Lamp Name: 3000K	Lamp Catalog: SMD2835	Test Lab:
Manufacture:	Test Machine:GON-2000	Test Date: 2019/03/22

Space ISO Illuminance Curve

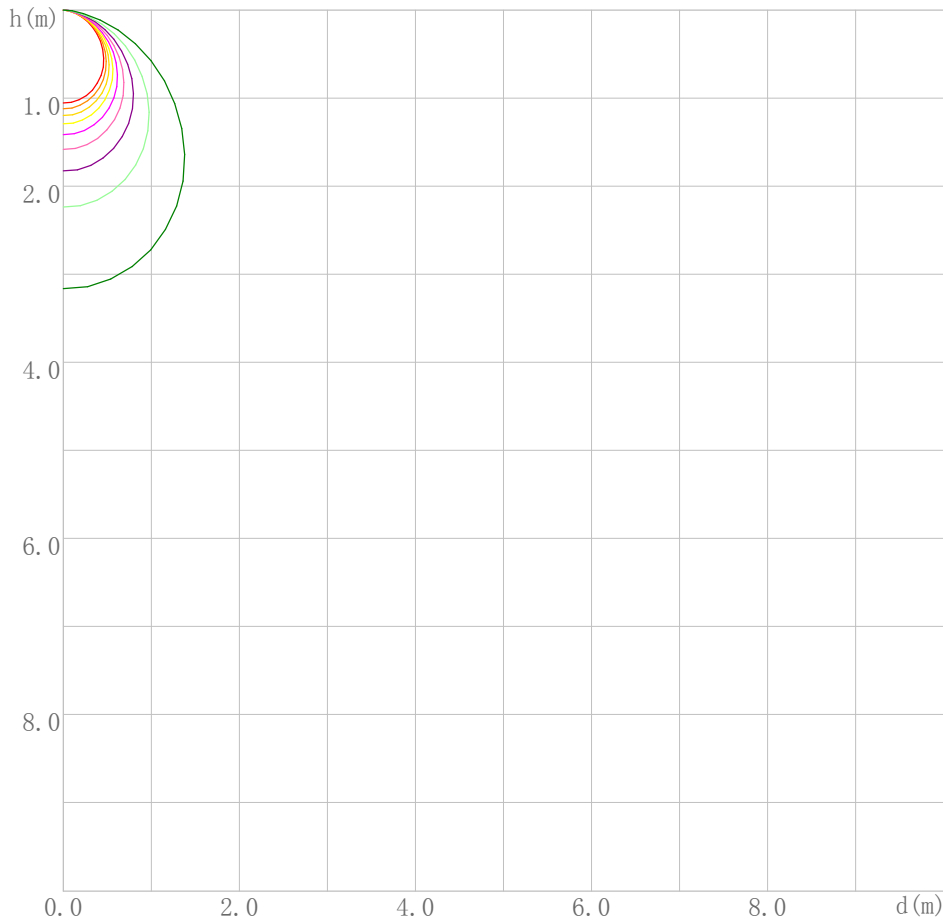

- Curves:
unit:lx
[EMax] =450.736
- [EMax*90%]=405.662
 - [EMax*80%]=360.589
 - [EMax*70%]=315.515
 - [EMax*60%]=270.442
 - [EMax*50%]=225.368
 - [EMax*40%]=180.294
 - [EMax*30%]=135.221
 - [EMax*20%]=90.147
 - [EMax*10%]=45.074

Space Plane Maximum Illuminance and @Angle:450.74,0.0deg
Plane Maximum Lighting Intensity and @Angle:450.736cd,0deg

Illuminance-Distance Diagram

Lum. Name: ICDLR12512WCCT-3K	Lum. Catalog: LED DOWNLIGHT	Test ID:
Lamp Name: 3000K	Lamp Catalog: SMD2835	Test Lab:
Manufacture:	Test Machine:GON-2000	Test Date: 2019/03/22

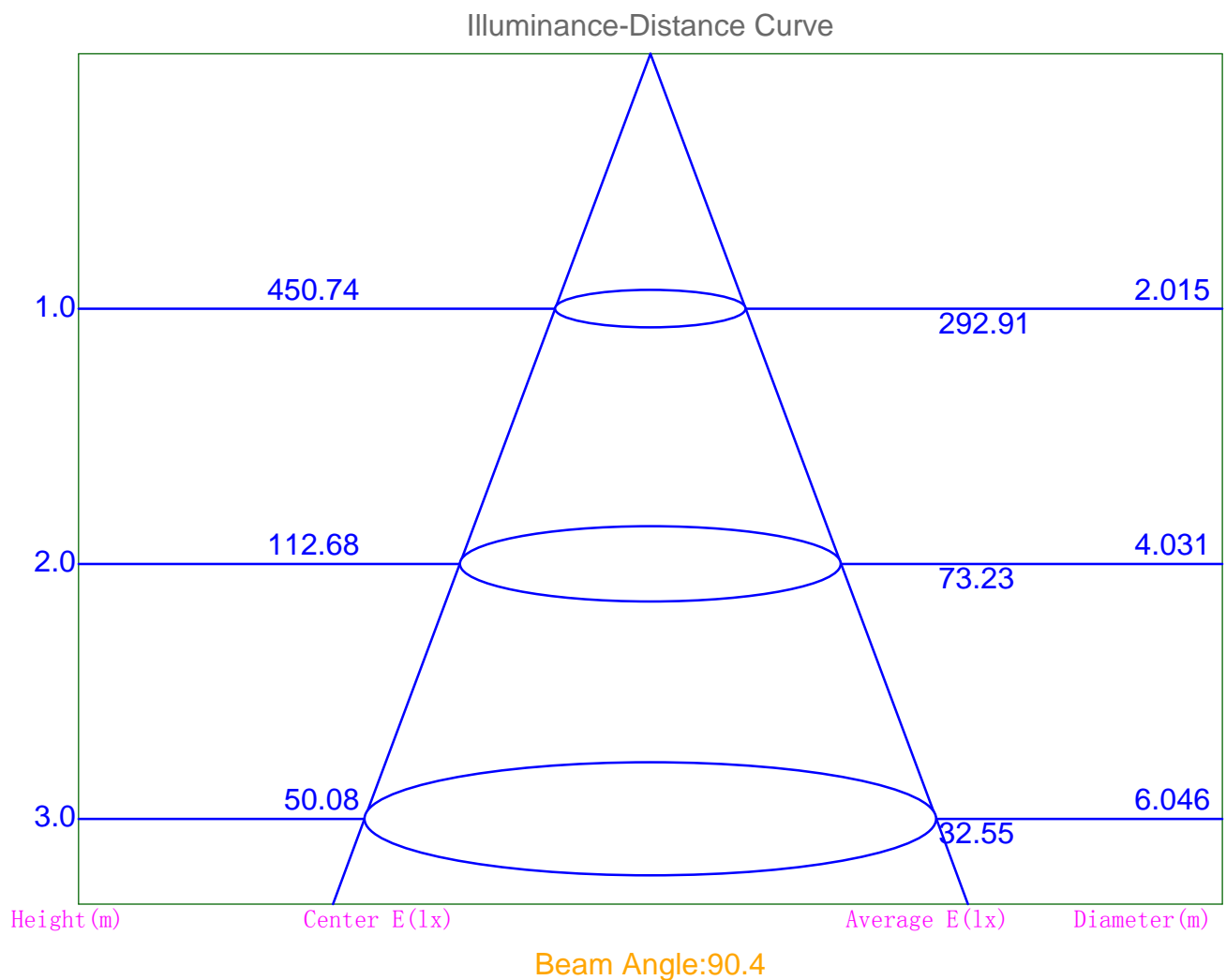

Indoor Luminance Limiting Curves

Lum. Name: ICDLR12512WCCT-3K	Lum. Catalog: LED DOWNLIGHT	Test ID:
Lamp Name: 3000K	Lamp Catalog: SMD2835	Test Lab:
Manufacture:	Test Machine:GON-2000	Test Date: 2019/03/22

Glare Grade Table

GI	Quality	Using Illuminance							
		a	b	c	d	e	f	g	h
1.15	A	2000	1000	500	<=300				
1.5	B		2000	1000	500	<=300			
1.85	C			2000	1000	500	<=300		
2.2	D				2000	1000	500	<=300	
2.55	E	a				2000	1000	500	<=300
			b	c	d	e	f	g	h

Luminance Table

Gama (deg)	45	50	55	60	65	70	75	80	85
C0	20114	18372	16580	14688	12665	10409	7786	4936	3759
C90	17868	16019	14093	12060	9856	7396	4602	1924	319

Luminance Limiting Curve

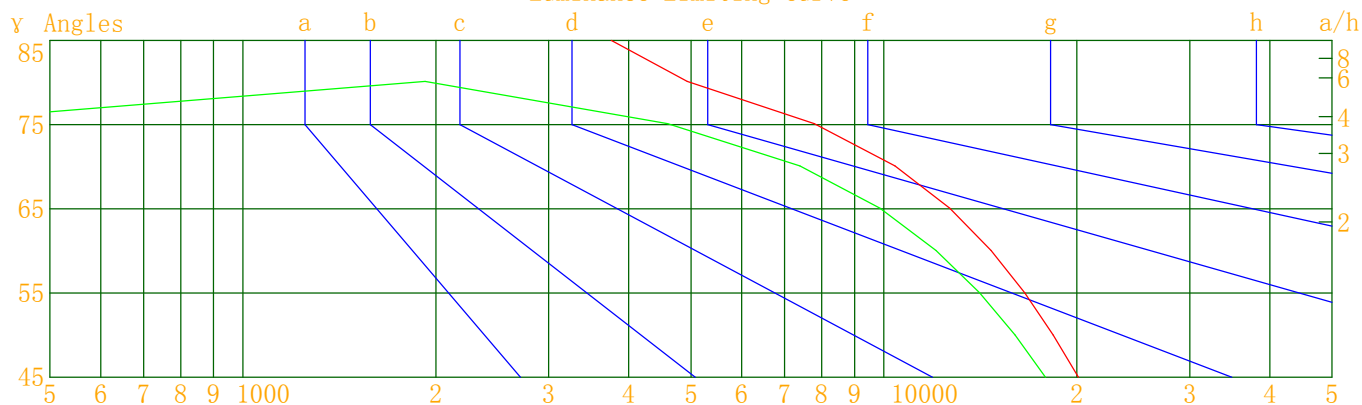

Luminous Size: Length(m)=0.108 Width(m)=0.108 Height(m)=0.042 Area(m^2)=0.016200
 Luminous Type: Without Luminous Side
 Luminous Curves: C0-C180 Color: — C90-C270 Color: —

Indoor Budgetary Estimate Table

Lum. Name: ICDLR12512WCCT-3K	Lum. Catalog: LED DOWNLIGHT	Test ID:
Lamp Name: 3000K	Lamp Catalog: SMD2835	Test Lab:
Manufacture:	Test Machine:GON-2000	Test Date: 2019/03/22

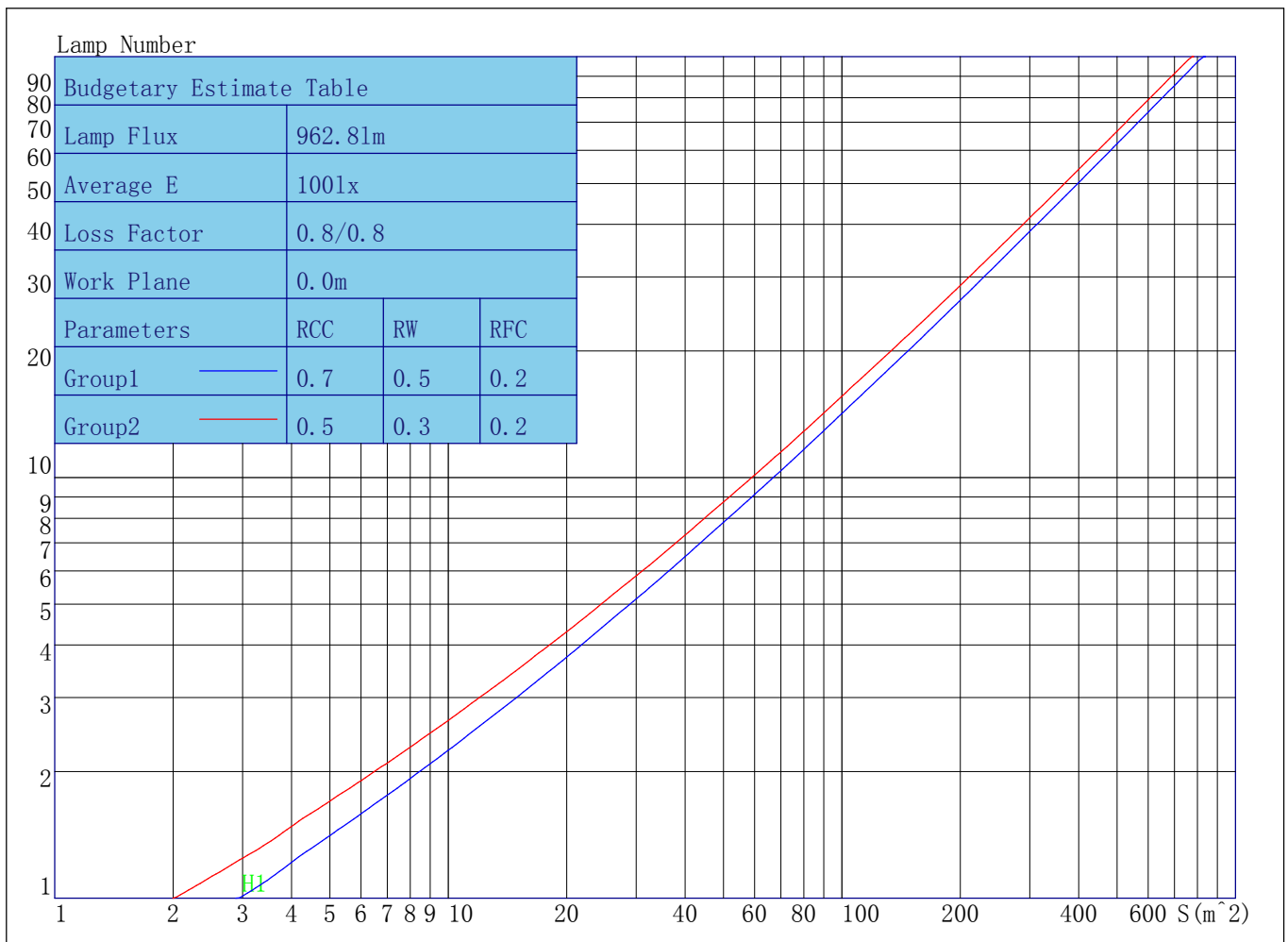

Parameters1: Rhocc = 0.7 Rhow = 0.5 Rhofc = 0.2 LLF = 0.8
 Parameters2: Rhocc = 0.5 Rhow = 0.3 Rhofc = 0.2 LLF = 0.8
 Average Illuminance(lx): 100 Cavity Height: H1(m) = 2

IES Indoor Report

Photometric Filename:ICDLR12512WCCT-3K.IES

Indoor Coefficient of Utilization Table

Lum. Name: ICDLR12512WCCT-3K	Lum. Catalog: LED DOWNLIGHT	Test ID:
Lamp Name: 3000K	Lamp Catalog: SMD2835	Test Lab:
Manufacture:	Test Machine:GON-2000	Test Date: 2019/03/22

Coefficients of Utilization - Zonal Cavity Method																		
Coef.	Effective Floor Cavity Reflectance RFC=0.20																	
RhoCC (%)	80				70				50			30			10			0
RhoW (%)	70	50	30	10	70	50	30	10	50	30	10	50	30	10	50	30	10	0
RCR	Coefficient of Utilization(%)																	
0	119	119	119	119	116	116	116	116	110	110	110	105	105	105	101	101	101	99
1	110	106	102	99	107	104	100	97	99	97	94	95	93	91	91	90	88	86
2	101	94	88	83	99	92	87	82	88	84	80	85	81	78	82	79	76	74
3	93	84	76	71	91	82	75	70	79	73	69	76	71	67	74	70	66	64
4	86	75	67	61	84	74	66	60	71	65	60	69	63	59	66	62	58	56
5	79	68	59	53	77	67	59	53	64	58	52	62	56	52	60	55	51	49
6	74	61	53	47	72	60	53	47	59	52	46	57	51	46	55	50	45	43
7	69	56	48	42	67	55	47	42	54	47	42	52	46	41	51	45	41	39
8	64	51	43	38	63	51	43	38	49	42	37	48	42	37	47	41	37	35
9	60	47	40	34	59	47	39	34	46	39	34	44	38	34	43	38	34	32
10	56	44	36	31	55	43	36	31	42	36	31	41	35	31	40	35	31	29

IES Indoor Report

Photometric Filename:ICDLR12512WCCT-3K.IES

Unified Glare Rating Table

Lum. Name: ICDLR12512WCCT-3K	Lum. Catalog: LED DOWNLIGHT	Test ID:
Lamp Name: 3000K	Lamp Catalog: SMD2835	Test Lab:
Manufacture:	Test Machine:GON-2000	Test Date: 2019/03/22

Unified Glare Rating Table

Ceiling RCC	0.70	0.70	0.50	0.50	0.30	0.70	0.70	0.50	0.50	0.30
Wall RW	0.50	0.30	0.50	0.30	0.30	0.50	0.30	0.50	0.30	0.30
Floor RFC	0.20	0.20	0.20	0.20	0.20	0.20	0.20	0.20	0.20	0.20
Room Size	Vewed crosswise					Vewed endwise				
X=2H Y=2H	36.9	40.1	37.7	40.8	41.4	35.9	39.1	36.7	39.8	40.5
Y=3H	39.6	42.8	40.4	43.5	44.2	38.1	41.3	38.9	42.0	42.6
Y=4H	41.3	44.0	42.1	44.7	45.4	39.4	42.1	40.2	42.8	43.5
Y=6H	41.8	44.5	42.6	45.2	45.8	39.6	42.3	40.4	43.0	43.6
Y=8H	41.9	44.6	42.7	45.3	45.9	39.6	42.2	40.4	42.9	43.6
Y=12H	42.0	44.6	42.8	45.3	45.9	39.6	42.2	40.4	42.9	43.5
X=4H Y=2H	37.7	40.4	38.5	41.1	41.8	37.0	39.7	37.8	40.4	41.0
Y=3H	40.6	43.3	41.4	44.0	44.6	39.3	42.0	40.1	42.7	43.4
Y=4H	40.7	42.1	41.7	43.0	43.9	39.0	40.5	40.0	41.4	42.3
Y=6H	41.4	42.7	42.4	43.7	44.5	39.4	40.7	40.5	41.7	42.5
Y=8H	41.6	42.9	42.6	43.8	44.7	39.5	40.7	40.5	41.7	42.5
Y=12H	40.8	41.8	42.0	42.9	43.8	38.5	39.6	39.7	40.6	41.6
X=8H Y=4H	40.7	42.0	41.7	42.9	43.8	39.1	40.4	40.2	41.3	42.2
Y=6H	40.7	41.5	41.8	42.6	43.5	38.8	39.6	39.9	40.7	41.6
Y=8H	40.4	41.1	41.6	42.2	43.2	38.4	39.0	39.6	40.2	41.2
Y=12H	40.6	41.2	41.8	42.3	43.4	38.4	39.0	39.5	40.1	41.1
X=12H Y=4H	39.8	40.8	40.9	41.8	42.8	38.2	39.2	39.3	40.3	41.2
Y=6H	40.1	40.8	41.3	42.0	43.0	38.2	38.9	39.4	40.1	41.1
Y=8H	40.4	41.0	41.6	42.2	43.2	38.3	39.0	39.5	40.1	41.1
Variations with the objver position at spacings										
S=1.0H	3.3/-1.4					3.5/-0.9				
S=1.5H	-1.4/-22.5					-0.4/-20.9				
S=2.0H	-1.4/-22.5					-0.4/-20.9				

IES Indoor Report

Photometric Filename:ICDLR12512WCCT-3K.IES

Candela Tabulation

V/H	C0.0	C90.0	C180.0	C270.0
Y 0.0	450.74	450.74	450.74	450.74
Y 5.0	449.60	440.34	448.43	447.30
Y 10.0	440.03	426.63	437.64	440.65
Y 15.0	423.77	406.91	420.61	427.36
Y 20.0	402.06	381.94	397.62	408.14
Y 25.0	374.77	352.33	369.60	383.20
Y 30.0	343.61	319.36	337.67	353.85
Y 35.0	308.39	282.76	302.48	320.59
Y 40.0	269.84	243.75	263.55	283.50
Y 45.0	230.41	204.68	223.75	244.45
Y 50.0	191.31	166.81	184.85	205.33
Y 55.0	154.06	130.95	147.65	167.40
Y 60.0	118.97	97.68	112.60	131.59
Y 65.0	86.71	67.48	80.53	98.18
Y 70.0	57.67	40.98	51.80	67.94
Y 75.0	32.65	19.30	27.37	41.36
Y 80.0	13.89	5.41	9.91	19.29
Y 85.0	5.31	0.45	2.83	6.76
Y 90.0	1.03	0.00	0.00	1.85
Y 95.0	0.96	0.00	0.00	1.07
Y 100.0	0.97	0.00	0.04	0.97
Y 105.0	1.17	0.28	0.33	1.13
Y 110.0	1.39	0.63	0.65	1.25
Y 115.0	1.61	0.94	1.03	1.49
Y 120.0	1.88	1.35	1.34	1.76
Y 125.0	2.15	1.65	1.77	1.99
Y 130.0	2.47	2.07	2.09	2.32
Y 135.0	2.72	2.33	2.45	2.54
Y 140.0	3.08	2.69	2.81	2.85
Y 145.0	3.30	3.02	3.09	3.12
Y 150.0	3.63	3.28	3.47	3.34
Y 155.0	3.88	3.63	3.71	3.67
Y 160.0	4.14	3.83	4.02	3.89
Y 165.0	4.35	4.09	4.32	4.18
Y 170.0	4.57	4.30	4.52	4.41
Y 175.0	4.68	4.44	4.66	4.61
Y 180.0	4.71	4.71	4.71	4.71
