

Indoor Luminaire Photometric Data

Description Information

Lum. Name: ICDLR10W4K-WH	Lum. Catalog: LED DOWNLIGHT	Test ID:
Lamp Name: 4000K	Lamp Catalog: SMD5630	Test Date: 2019/06/12
Manufacture:	ShldAngle(°):	Test Machine:GON-2000
Test Lab:	Frequency(Hz):	Lamp CCT(K): Ra:
Lum. Size(W*L*H):0.085m*0.085m*0.035m	Lum. Area(m2):0.010	Lum. W(kg): 2.000
Test System: C, γ	Test Step: C=90.0 γ=5.0	Temp.(°C): 25
		Humidity(%):

Character Parameter

Lamp Speciality Parameter		Luminaire Speciality Parameter	
Rated Flux(lm): 768.570	Luminaire Flux: 768.572lm	Field Angle(10%Imax): 150.3	
Rated Power(W):	Luminaire Efficiency: 100.00%	Down Lumens&Percent: 768.549lm 100.00%	
Rated Voltage(V):	Luminaire EER(lm/W): 75.056	Up Lumens&Percent: 0.023lm 0.00%	
Tested Power(W): 10.240	Max. Cand. (cd): 346.852	S/MH: C0_a180=1.130 C90_270=1.129	
Lamps' Inside: 1	Max Cand@Ang. (°): C=270.0 γ=5.0	CIE Type: Semi-Direct	
Tested Electric:U=238.1V, I=0.053A, PF=0.000	Beam Angle(50%Imax): 91.3	ErP Φuse(120°): 635.337lm	
Lamp Size(W*L*H):0.085m*0.085m*0.035m	Left=-43.0 Right=48.3	IRF: 126.540%	

Lighting Distribution Diagram

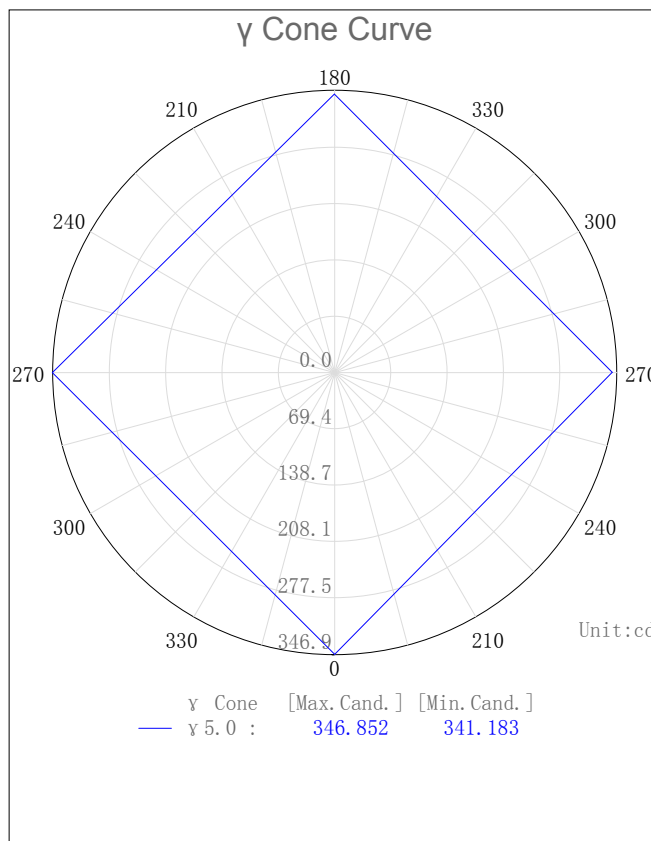
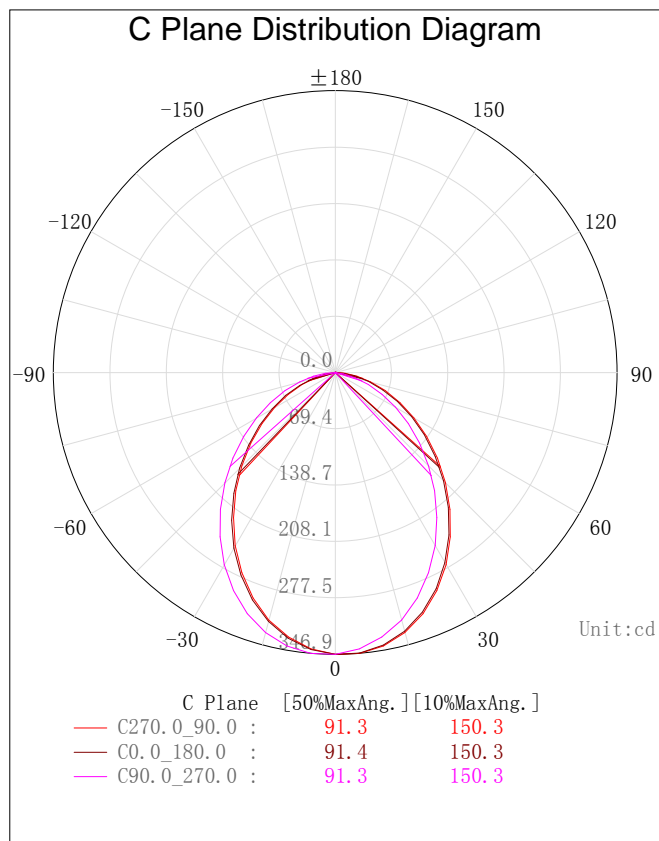

3D Light Intensity Distribution Modal

Lum. Name: ICDLR10W4K-WH	Lum. Catalog: LED DOWNLIGHT	Test ID:
Lamp Name: 4000K	Lamp Catalog: SMD5630	Test Lab:
Manufacture:	Test Machine:GON-2000	Test Date: 2019/06/12

3D Light Intensity Distribution Modal

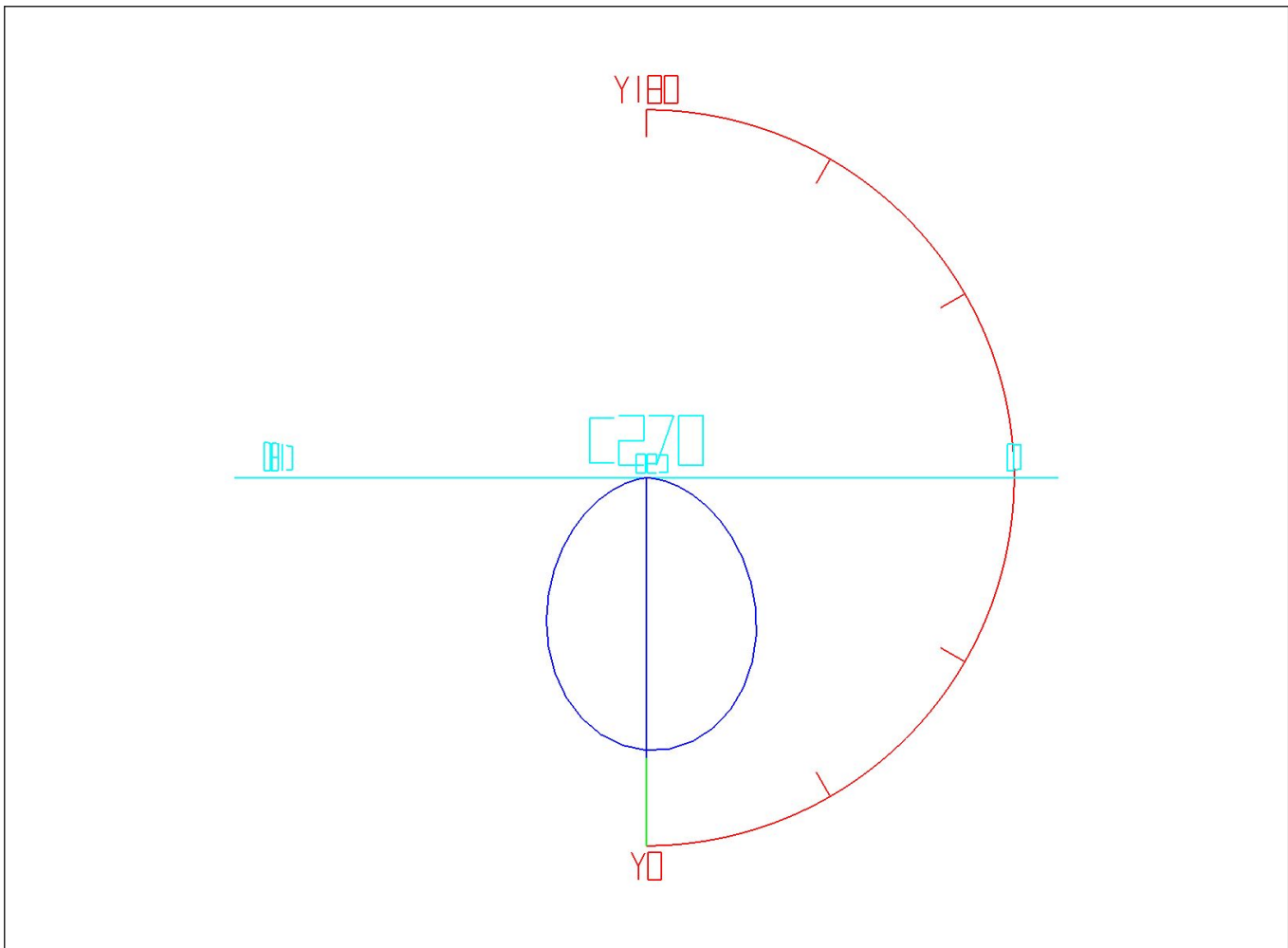

Curves: 3D Model ——— Fixture ——— Vert. HUD ——— Hori. HUD ———
View Angles: Orient:0 Tilt:0 Roll:0 Spin:0

IES Indoor Report

Photometric Filename:ICDLR10W4K-WH.IES

Zonal Flux Tabulation

Zone (y)	Zone Flux (lm)	Sums Flux (lm)	Zone%Lamp	Sums%Lamp
0.0-5.0	8.26	8.26	1.07	1.07
5.0-10.0	24.33	32.59	3.17	4.24
10.0-15.0	39.11	71.70	5.09	9.33
15.0-20.0	51.83	123.53	6.74	16.07
20.0-25.0	61.85	185.38	8.05	24.12
25.0-30.0	68.79	254.17	8.95	33.07
30.0-35.0	72.49	326.66	9.43	42.50
35.0-40.0	73.04	399.70	9.50	52.01
40.0-45.0	70.74	470.44	9.20	61.21
45.0-50.0	66.04	536.48	8.59	69.80
50.0-55.0	59.42	595.90	7.73	77.53
55.0-60.0	51.40	647.30	6.69	84.22
60.0-65.0	42.42	689.73	5.52	89.74
65.0-70.0	32.93	722.65	4.28	94.03
70.0-75.0	23.39	746.04	3.04	97.07
75.0-80.0	14.36	760.41	1.87	98.94
80.0-85.0	6.58	766.98	0.86	99.79
85.0-90.0	1.56	768.55	0.20	100.00
90.0-95.0	0.02	768.57	0.00	100.00
95.0-100.0	0.00	768.57	0.00	100.00
100.0-105.0	0.00	768.57	0.00	100.00
105.0-110.0	0.00	768.57	0.00	100.00
110.0-115.0	0.00	768.57	0.00	100.00
115.0-120.0	0.00	768.57	0.00	100.00
120.0-125.0	0.00	768.57	0.00	100.00
125.0-130.0	0.00	768.57	0.00	100.00
130.0-135.0	0.00	768.57	0.00	100.00
135.0-140.0	0.00	768.57	0.00	100.00
140.0-145.0	0.00	768.57	0.00	100.00
145.0-150.0	0.00	768.57	0.00	100.00
150.0-155.0	0.00	768.57	0.00	100.00
155.0-160.0	0.00	768.57	0.00	100.00
160.0-165.0	0.00	768.57	0.00	100.00
165.0-170.0	0.00	768.57	0.00	100.00
170.0-175.0	0.00	768.57	0.00	100.00
175.0-180.0	0.00	768.57	0.00	100.00

Rectangle ISO Lighting Intensity Diagram

Lum. Name: ICDLR10W4K-WH	Lum. Catalog: LED DOWNLIGHT	Test ID:
Lamp Name: 4000K	Lamp Catalog: SMD5630	Test Lab:
Manufacture:	Test Machine:GON-2000	Test Date: 2019/06/12

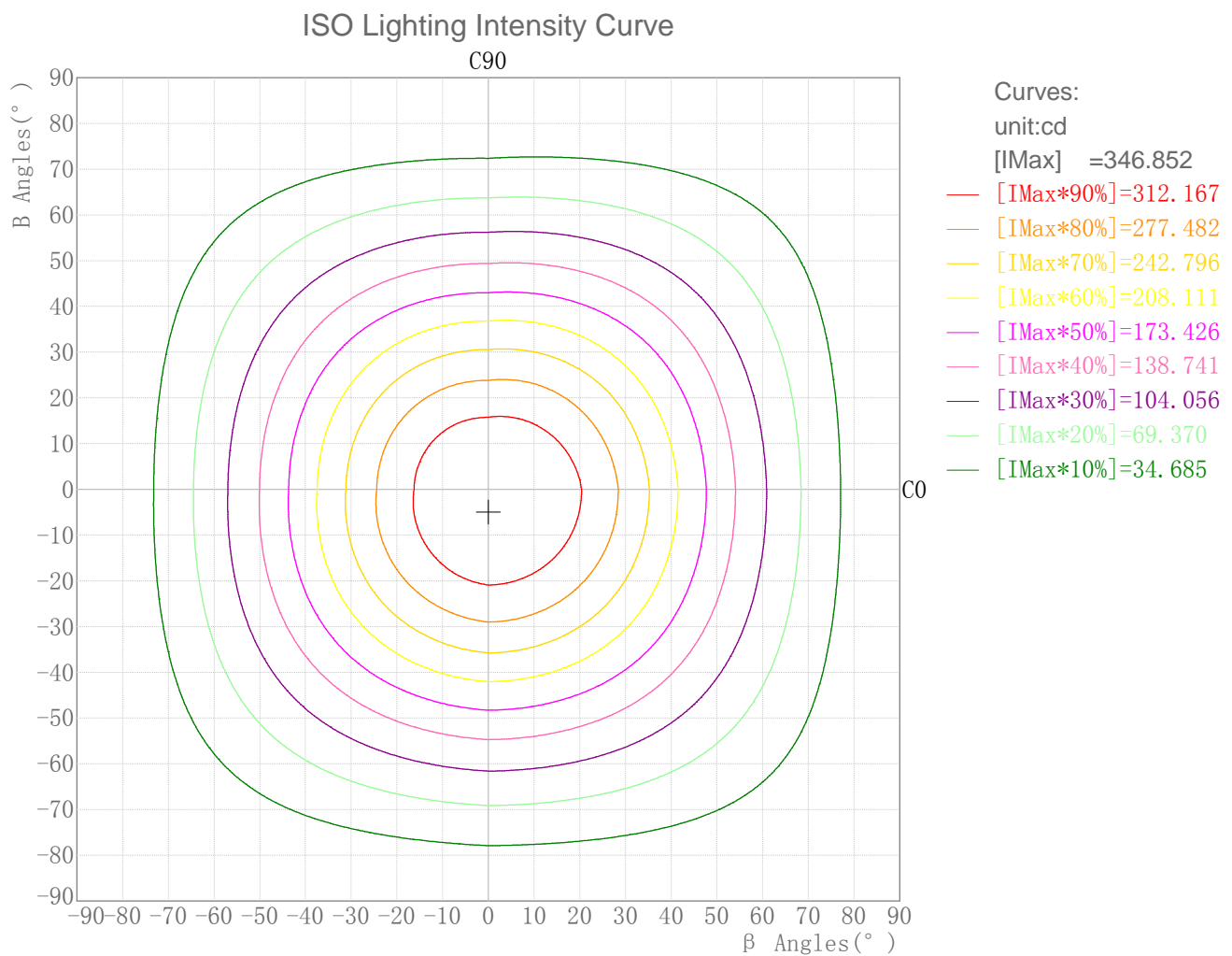

Maximum Light Intensity(cd): 346.85
Maximum Cand.@Angle: H=-0.0°,V=-5.0°

Plane ISO-Illuminance Diagram

Lum. Name: ICDLR10W4K-WH	Lum. Catalog: LED DOWNLIGHT	Test ID:
Lamp Name: 4000K	Lamp Catalog: SMD5630	Test Lab:
Manufacture:	Test Machine:GON-2000	Test Date: 2019/06/12

Plane ISO-Illuminance Curve

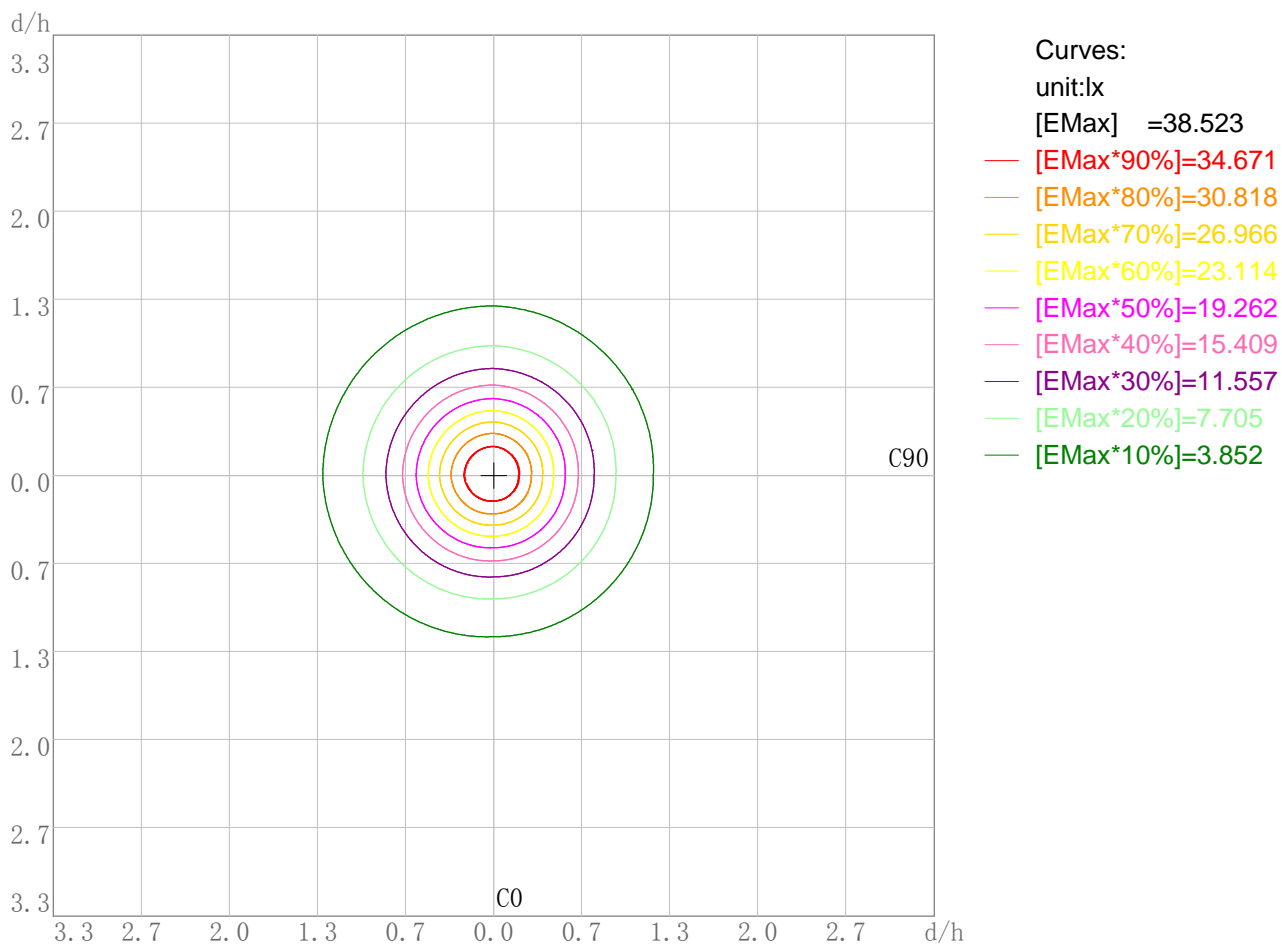

Working Plane Luminaire Mounting Height(m): 3.00
 Working Plane Maximum Illuminance(lx): 38.52
 Working Plane Maximum Illuminance Position(d/h):H0.0 V0.0

3D Plane ISO Illuminance Diagram

Lum. Name: ICDLR10W4K-WH	Lum. Catalog: LED DOWNLIGHT	Test ID:
Lamp Name: 4000K	Lamp Catalog: SMD5630	Test Lab:
Manufacture:	Test Machine:GON-2000	Test Date: 2019/06/12

3D Plane Illuminance Modal

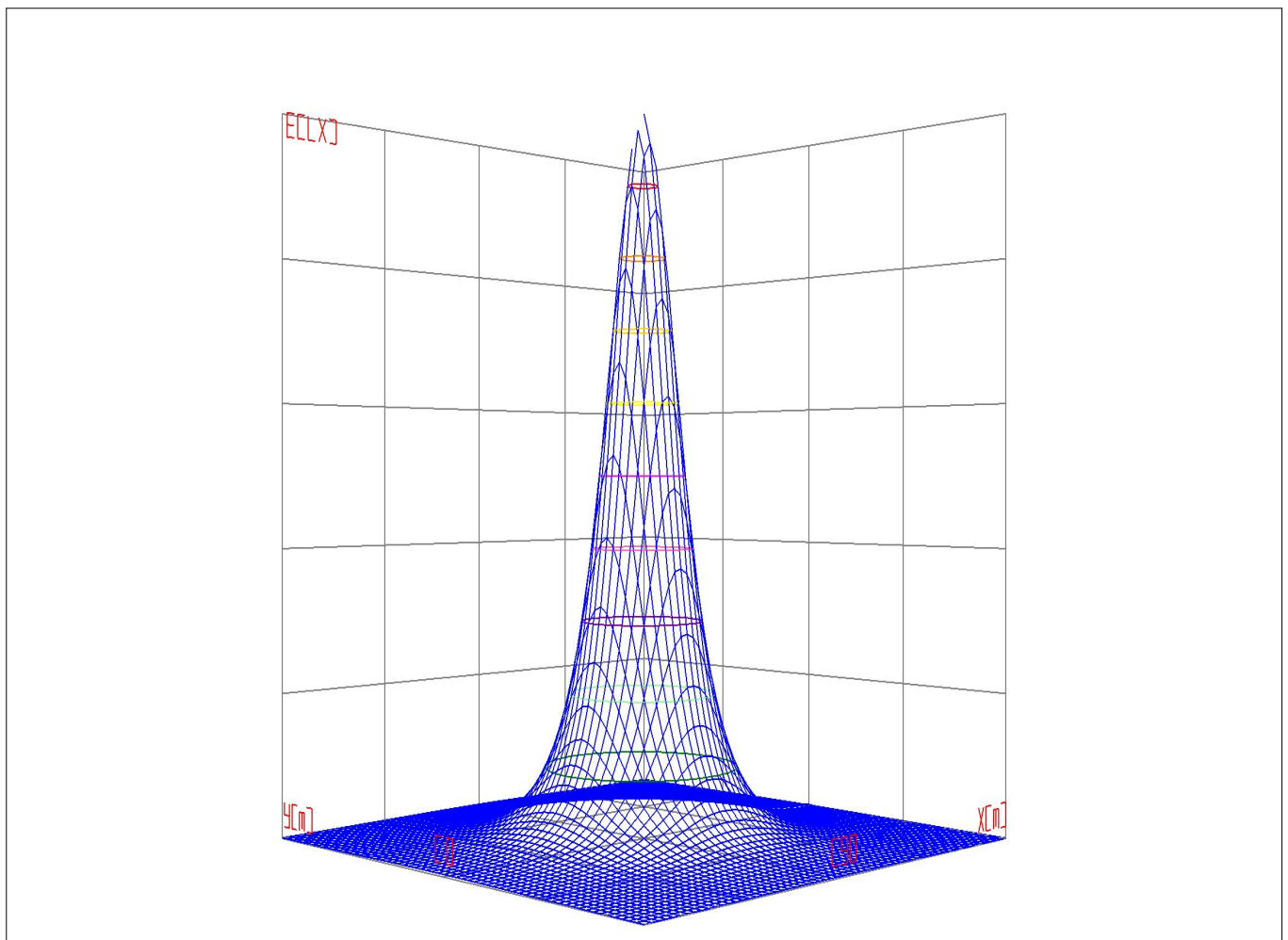

Curves: 3D Model — 90% — 80% — 70% — 60% — 50% — 40% — 30% — 20% — 10% —
View Angles(deg): 0 Height(m): 3.0 Distance(m): 10.0

Space ISO Illuminance Diagram

Lum. Name: ICDLR10W4K-WH	Lum. Catalog: LED DOWNLIGHT	Test ID:
Lamp Name: 4000K	Lamp Catalog: SMD5630	Test Lab:
Manufacture:	Test Machine:GON-2000	Test Date: 2019/06/12

Space ISO Illuminance Curve

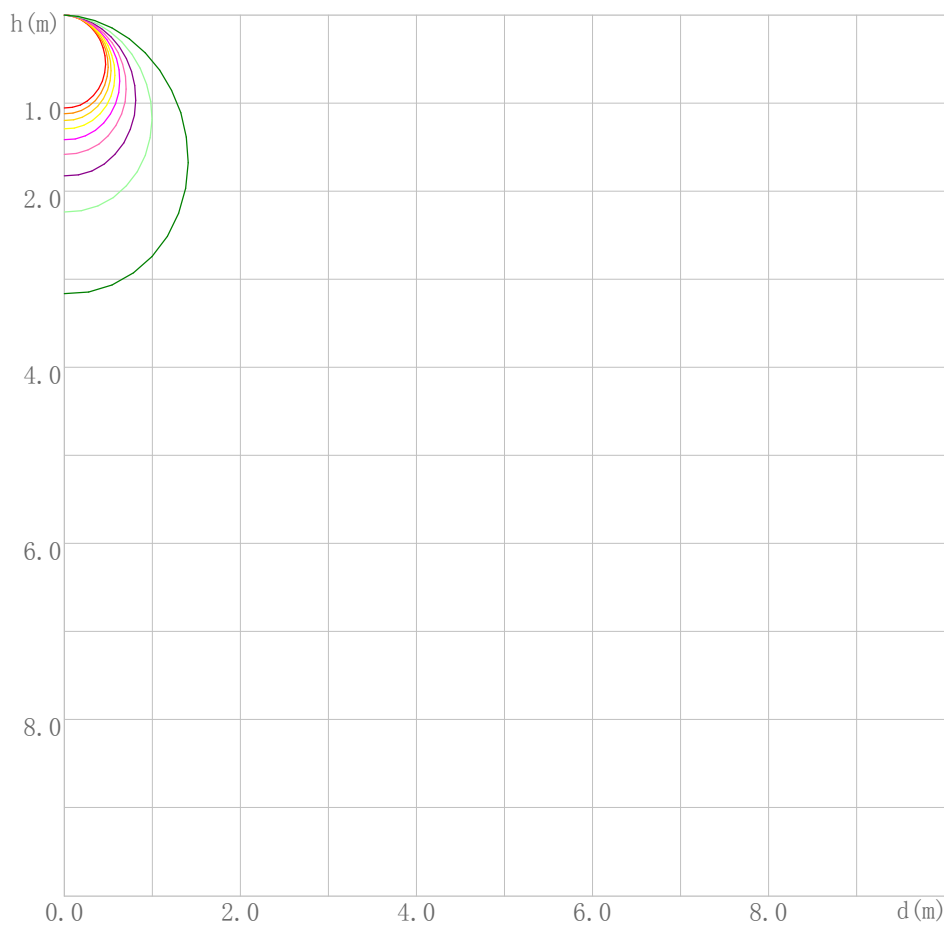

- Curves:
unit:lx
[EMax] =346.707
- [EMax*90%]=312.036
 - [EMax*80%]=277.366
 - [EMax*70%]=242.695
 - [EMax*60%]=208.024
 - [EMax*50%]=173.354
 - [EMax*40%]=138.683
 - [EMax*30%]=104.012
 - [EMax*20%]=69.341
 - [EMax*10%]=34.671

Space Plane Maximum Illuminance and @Angle:346.71,0.0deg
Plane Maximum Lighting Intensity and @Angle:346.707cd,0deg

Illuminance-Distance Diagram

Lum. Name: ICDLR10W4K-WH	Lum. Catalog: LED DOWNLIGHT	Test ID:
Lamp Name: 4000K	Lamp Catalog: SMD5630	Test Lab:
Manufacture:	Test Machine:GON-2000	Test Date: 2019/06/12

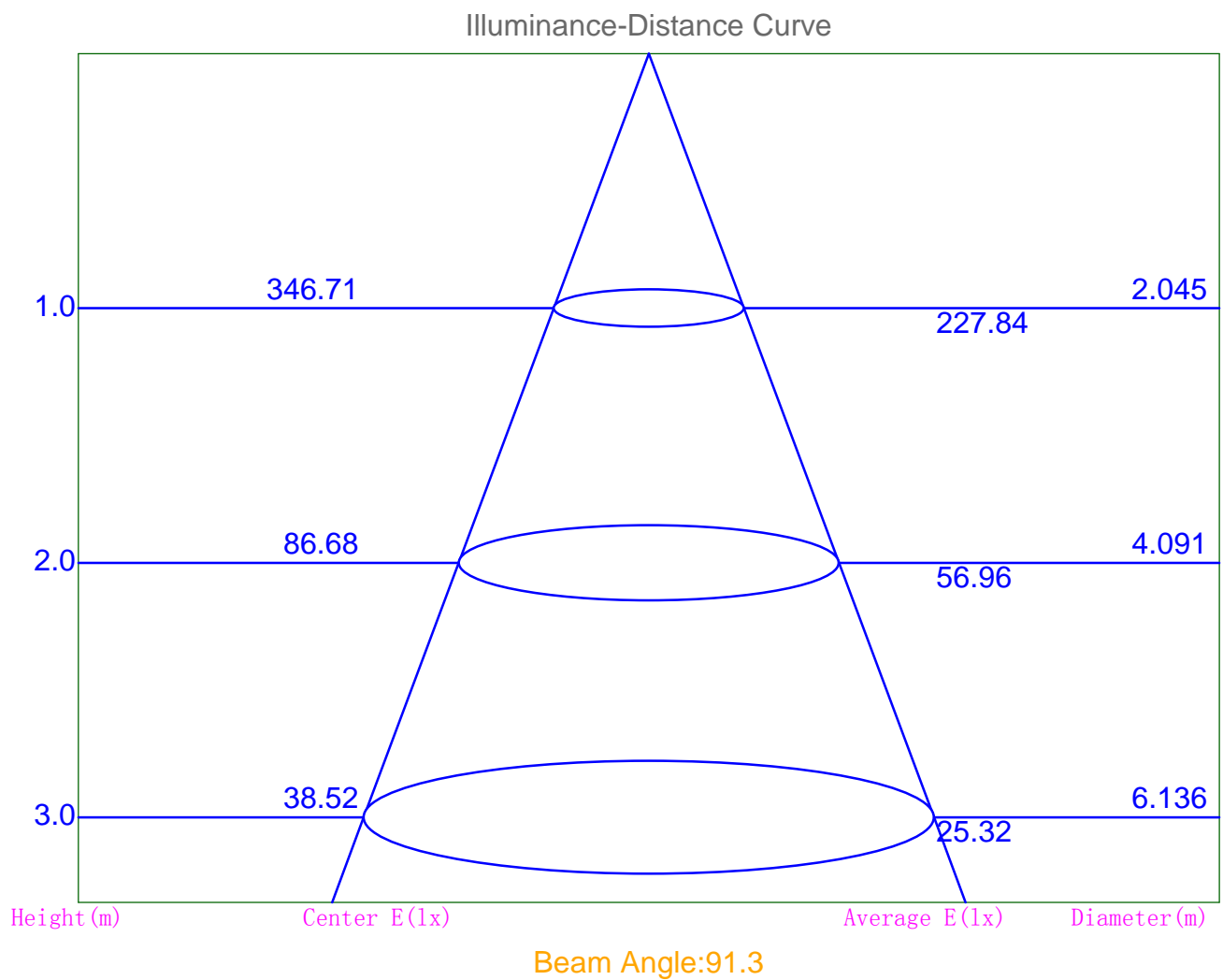

Indoor Luminance Limiting Curves

Lum. Name: ICDLR10W4K-WH	Lum. Catalog: LED DOWNLIGHT	Test ID:
Lamp Name: 4000K	Lamp Catalog: SMD5630	Test Lab:
Manufacture:	Test Machine:GON-2000	Test Date: 2019/06/12

Glare Grade Table

GI	Quality	Using Illuminance							
		a	b	c	d	e	f	g	h
1.15	A	2000	1000	500	<=300				
1.5	B		2000	1000	500	<=300			
1.85	C			2000	1000	500	<=300		
2.2	D				2000	1000	500	<=300	
2.55	E	a				2000	1000	500	<=300
			b	c	d	e	f	g	h

Luminance Table

Gama (deg)	45	50	55	60	65	70	75	80	85
C0	26119	24492	22854	21223	19573	17852	15927	13748	10856
C90	22493	20645	18762	16822	14737	12373	9562	5736	0

Luminance Limiting Curve

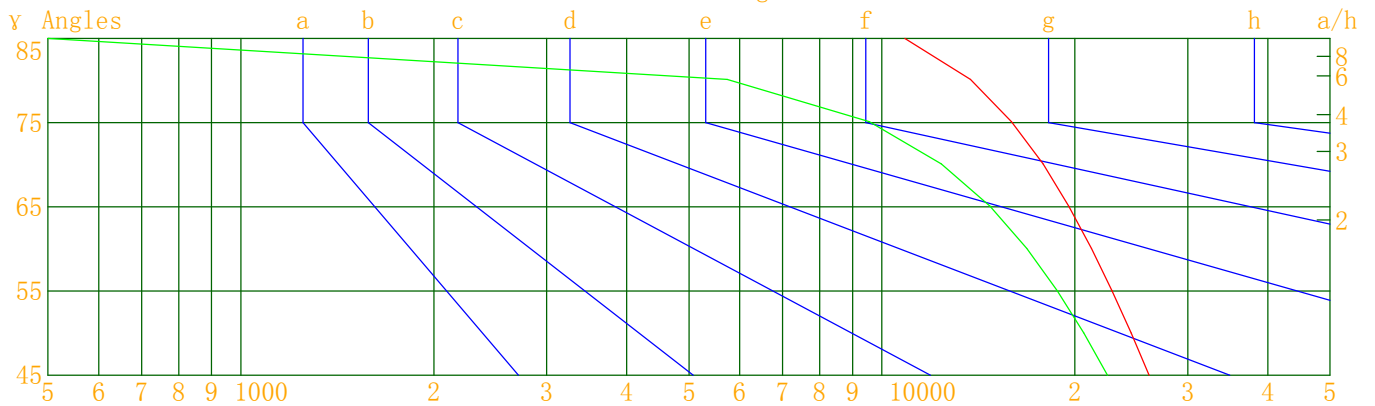

Luminous Size: Length(m)=0.085 Width(m)=0.085 Height(m)=0.035 Area(m²)=0.010200
 Luminous Type: Without Luminous Side
 Luminous Curves: C0-C180 Color: — C90-C270 Color: —

Indoor Budgetary Estimate Table

Lum. Name: ICDLR10W4K-WH	Lum. Catalog: LED DOWNLIGHT	Test ID:
Lamp Name: 4000K	Lamp Catalog: SMD5630	Test Lab:
Manufacture:	Test Machine:GON-2000	Test Date: 2019/06/12

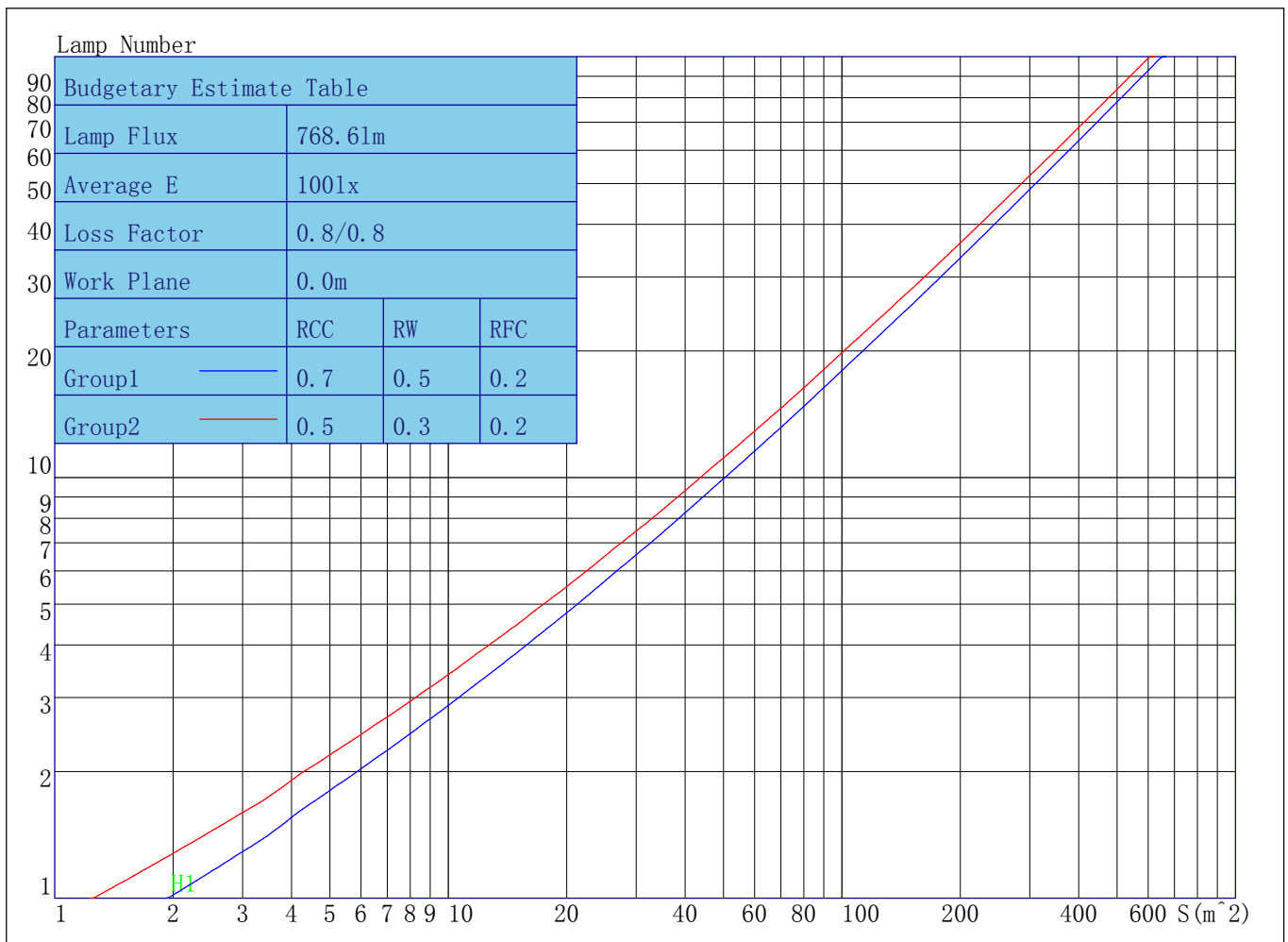

Parameters1: Rhocc = 0.7 Rhow = 0.5 Rhofc = 0.2 LLF = 0.8
 Parameters2: Rhocc = 0.5 Rhow = 0.3 Rhofc = 0.2 LLF = 0.8
 Average Illuminance(lx): 100 Cavity Height: H1(m) = 2

Indoor Coefficient of Utilization Table

Lum. Name: ICDLR10W4K-WH	Lum. Catalog: LED DOWNLIGHT	Test ID:
Lamp Name: 4000K	Lamp Catalog: SMD5630	Test Lab:
Manufacture:	Test Machine:GON-2000	Test Date: 2019/06/12

Coefficients of Utilization - Zonal Cavity Method																		
Coef.	Effective Floor Cavity Reflectance RFC=0.20																	
RhoCC (%)	80				70				50			30			10			0
RhoW (%)	70	50	30	10	70	50	30	10	50	30	10	50	30	10	50	30	10	0
RCR	Coefficient of Utilization(%)																	
0	119	119	119	119	116	116	116	116	111	111	111	106	106	106	102	102	102	100
1	110	105	102	98	107	103	100	97	99	96	93	95	93	91	92	90	88	86
2	101	93	87	81	98	91	85	81	88	83	79	84	80	77	82	78	75	73
3	92	83	75	69	90	81	74	68	78	72	67	75	70	66	73	69	65	63
4	85	74	66	59	83	72	65	59	70	63	58	68	62	57	66	61	57	54
5	79	66	58	52	77	65	57	51	63	56	51	61	55	50	60	54	50	48
6	73	60	52	46	71	59	51	45	57	50	45	56	49	45	54	49	44	42
7	68	55	46	41	66	54	46	40	53	45	40	51	45	40	50	44	40	38
8	63	50	42	37	62	50	42	36	48	41	36	47	41	36	46	40	36	34
9	59	46	38	33	58	46	38	33	45	38	33	44	37	33	43	37	33	31
10	56	43	35	30	54	42	35	30	41	35	30	41	34	30	40	34	30	28

Unified Glare Rating Table

Lum. Name: ICDLR10W4K-WH	Lum. Catalog: LED DOWNLIGHT	Test ID:
Lamp Name: 4000K	Lamp Catalog: SMD5630	Test Lab:
Manufacture:	Test Machine:GON-2000	Test Date: 2019/06/12

Unified Glare Rating Table

Ceiling RCC	0.70	0.70	0.50	0.50	0.30	0.70	0.70	0.50	0.50	0.30
Wall RW	0.50	0.30	0.50	0.30	0.30	0.50	0.30	0.50	0.30	0.30
Floor RFC	0.20	0.20	0.20	0.20	0.20	0.20	0.20	0.20	0.20	0.20
Room Size	Vewed crosswise					Vewed endwise				
X=2H Y=2H	41.7	45.1	42.4	45.7	46.3	40.5	43.9	41.3	44.6	45.1
Y=3H	45.4	48.8	46.1	49.5	50.0	43.5	46.9	44.2	47.5	48.1
Y=4H	47.8	50.7	48.6	51.4	51.9	45.4	48.3	46.1	48.9	49.5
Y=6H	49.1	52.0	49.9	52.6	53.1	46.0	48.8	46.7	49.4	50.0
Y=8H	49.6	52.4	50.3	53.0	53.6	46.1	48.9	46.8	49.5	50.1
Y=12H	49.8	52.6	50.5	53.2	53.8	46.0	48.8	46.8	49.4	50.0
X=4H Y=2H	42.7	45.7	43.5	46.3	46.8	42.0	44.9	42.7	45.5	46.1
Y=3H	46.7	49.6	47.4	50.2	50.8	45.2	48.1	45.9	48.7	49.3
Y=4H	47.6	49.2	48.5	50.1	50.8	45.6	47.2	46.5	48.1	48.8
Y=6H	49.3	50.8	50.3	51.6	52.4	46.6	48.0	47.5	48.9	49.6
Y=8H	49.9	51.3	50.9	52.2	52.9	46.8	48.2	47.7	49.0	49.8
Y=12H	49.4	50.6	50.5	51.6	52.4	45.9	47.1	46.9	48.0	48.9
X=8H Y=4H	47.8	49.2	48.7	50.1	50.8	45.9	47.3	46.9	48.2	48.9
Y=6H	48.8	49.7	49.8	50.7	51.6	46.2	47.2	47.3	48.1	49.0
Y=8H	49.0	49.8	50.1	50.8	51.7	46.1	46.8	47.2	47.8	48.7
Y=12H	49.5	50.2	50.6	51.3	52.2	46.1	46.8	47.2	47.9	48.8
X=12H Y=4H	46.9	48.0	47.9	49.0	49.8	45.0	46.2	46.1	47.1	48.0
Y=6H	48.3	49.1	49.4	50.1	51.0	45.8	46.5	46.9	47.6	48.5
Y=8H	49.0	49.7	50.1	50.7	51.7	46.1	46.8	47.2	47.8	48.7
Variations with the objver position at spacings										
S=1.0H	2.9/-1.6					3.0/-0.4				
S=1.5H	-1.6/-20.9					-0.4/-18.9				
S=2.0H	-1.6/-20.9					-0.4/-18.9				

IES Indoor Report
Photometric Filename:ICDLR10W4K-WH.IES

Candela Tabulation

V/H	C0.0	C90.0	C180.0	C270.0
Y 0.0	346.71	346.71	346.71	346.71
Y 5.0	346.26	341.18	341.93	346.85
Y 10.0	340.47	330.58	331.91	341.64
Y 15.0	329.52	315.10	316.99	331.17
Y 20.0	313.71	295.28	297.73	315.86
Y 25.0	293.60	271.89	274.81	296.16
Y 30.0	270.05	245.81	249.18	272.89
Y 35.0	244.04	218.20	221.83	247.01
Y 40.0	216.49	190.03	193.81	219.61
Y 45.0	188.38	162.23	166.03	191.68
Y 50.0	160.58	135.36	139.05	164.01
Y 55.0	133.70	109.76	113.50	137.23
Y 60.0	108.24	85.79	89.47	111.77
Y 65.0	84.37	63.53	67.03	87.81
Y 70.0	62.28	43.17	46.45	65.54
Y 75.0	42.05	25.24	28.06	45.16
Y 80.0	24.35	10.16	12.59	27.12
Y 85.0	9.65	0.00	1.05	11.90
Y 90.0	0.00	0.00	0.00	0.26
Y 95.0	0.00	0.00	0.00	0.00
Y 100.0	0.00	0.00	0.00	0.00
Y 105.0	0.00	0.00	0.00	0.00
Y 110.0	0.00	0.00	0.00	0.00
Y 115.0	0.00	0.00	0.00	0.00
Y 120.0	0.00	0.00	0.00	0.00
Y 125.0	0.00	0.00	0.00	0.00
Y 130.0	0.00	0.00	0.00	0.00
Y 135.0	0.00	0.00	0.00	0.00
Y 140.0	0.00	0.00	0.00	0.00
Y 145.0	0.00	0.00	0.00	0.00
Y 150.0	0.00	0.00	0.00	0.00
Y 155.0	0.00	0.00	0.00	0.00
Y 160.0	0.00	0.00	0.00	0.00
Y 165.0	0.00	0.00	0.00	0.00
Y 170.0	0.05	0.00	0.00	0.00
Y 175.0	0.13	0.00	0.06	0.03
Y 180.0	0.12	0.12	0.12	0.12
