

Indoor Luminaire Photometric Data

Description Information

Luminary Name: PLUTOHB 120W 6000K		Lum. Catalog:	Test ID: adm
Lamp Name:		Lamp Catalog:	Test Date: 2024-04-10
Manufacture: Eurotech Lighting Ltd		Shld. Ang(°):	Test Machine:
Test Lab:		Frequency(Hz):	Lamp CCT(K): Ra:
Lum. Size (W*L*H): 0.000m*0.000m*0.000m		Lum. Area (m2): 0.000	Lum. W (kg):
Test System: C, γ	Test Step: C=45.0 γ=1.0	Temp. (°C):	Humidity (%):

Character Parameter

Lamp Speciality Parameter		Luminaire Speciality Parameter	
Rated Flux(lm): 20468.301	Luminary Flux(lm): 20471.654	Field Angle(10%Imax): 126.5(°)	
Rated Power(W):	Luminary Efficiency: 100.02%	Down Lumens&Percent: 20204.632lm 98.70%	
Rated Voltage(V):	Luminary EER(lm/W): 170.030	Up Lumens&Percent: 267.023lm 1.30%	
Tested Power(W): 120.400	Max. Candela(cd): 9885.900	S/MH: C0_a180=1.353 C90_270=1.347	
Lamps' Inside: 1	Max Cand@Ang. (°): C=45.0 γ=4.0	CIE Type: Semi-Direct	
Tested Electrics(V, A, pf):	Beam Angle(50%Imax): 89.2(°)	ErP Φuse(120°): 19083.133lm	
Lamp Size(W*L*H): 0.000m*0.000m*0.000m	Left=-45.0°, Right=44.3°	IRF (%): 118.897	

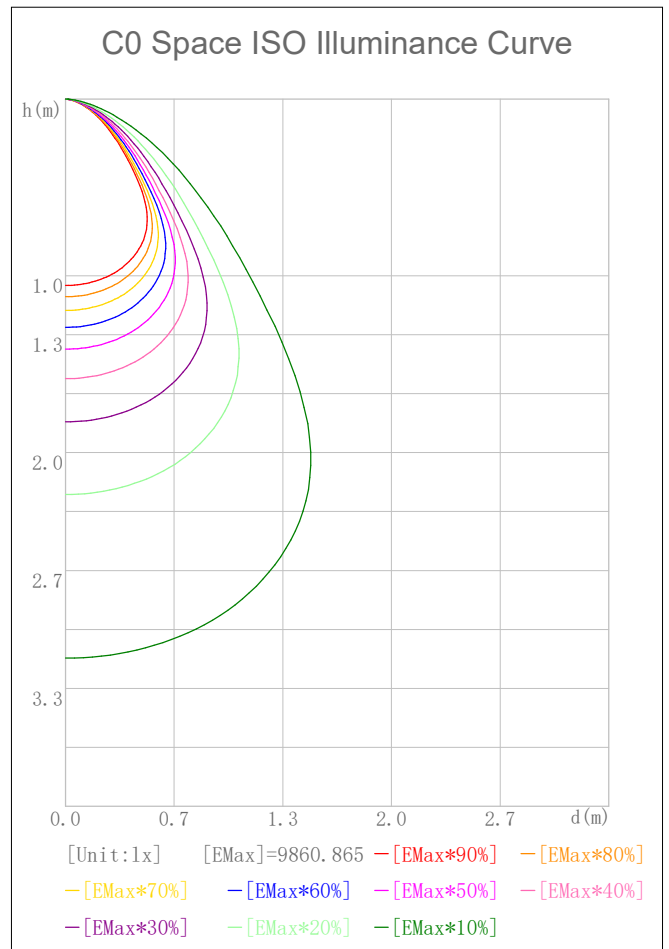
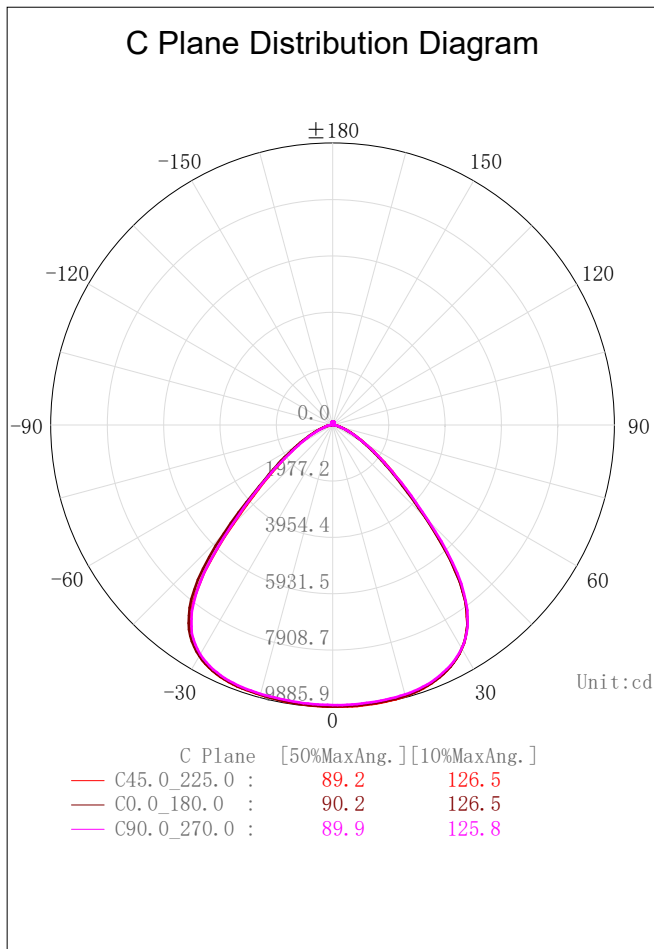

2D Plane Light Intensity Distribution Curve

Lum. Name: PLUTOHB 120W 6000K	Lum. Catalog:	Test ID: adm1
Lamp Name:	Lamp Catalog:	Test Lab:
Manufacture: Eurotech Lighting Ltd	Test Machine:	Test Date: 2024-04-10

C Plane Distribution Diagram

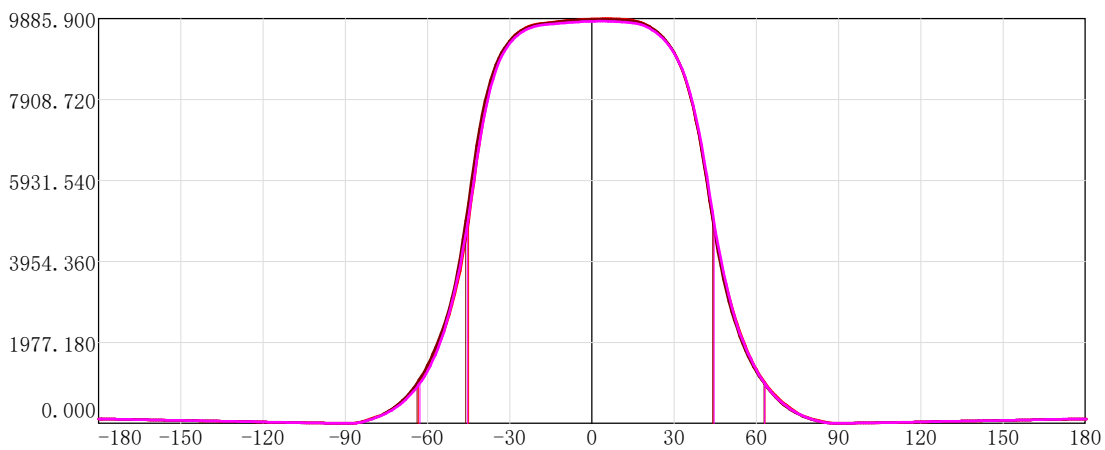
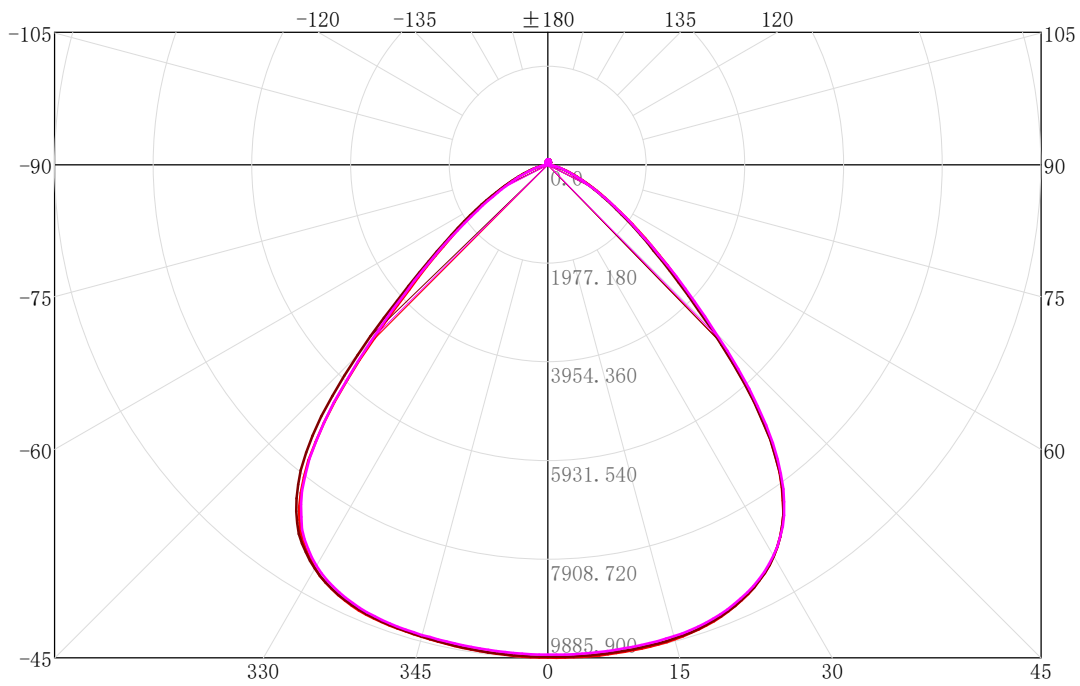

	C Plane	[50%MaxAng.]	[10%MaxAng.]	Unit:cd
—	C45.0_225.0 :	89.2	126.5	
—	C0.0_180.0 :	90.2	126.5	
—	C90.0_270.0 :	89.9	125.8	

3D Light Intensity Distribution Modal

Lum. Name: PLUTOHB 120W 6000K	Lum. Catalog:	Test ID: adm
Lamp Name:	Lamp Catalog:	Test Lab:
Manufacture: Eurotech Lighting Ltd	Test Machine:	Test Date: 2024-04-10

3D Light Intensity Distribution Modal

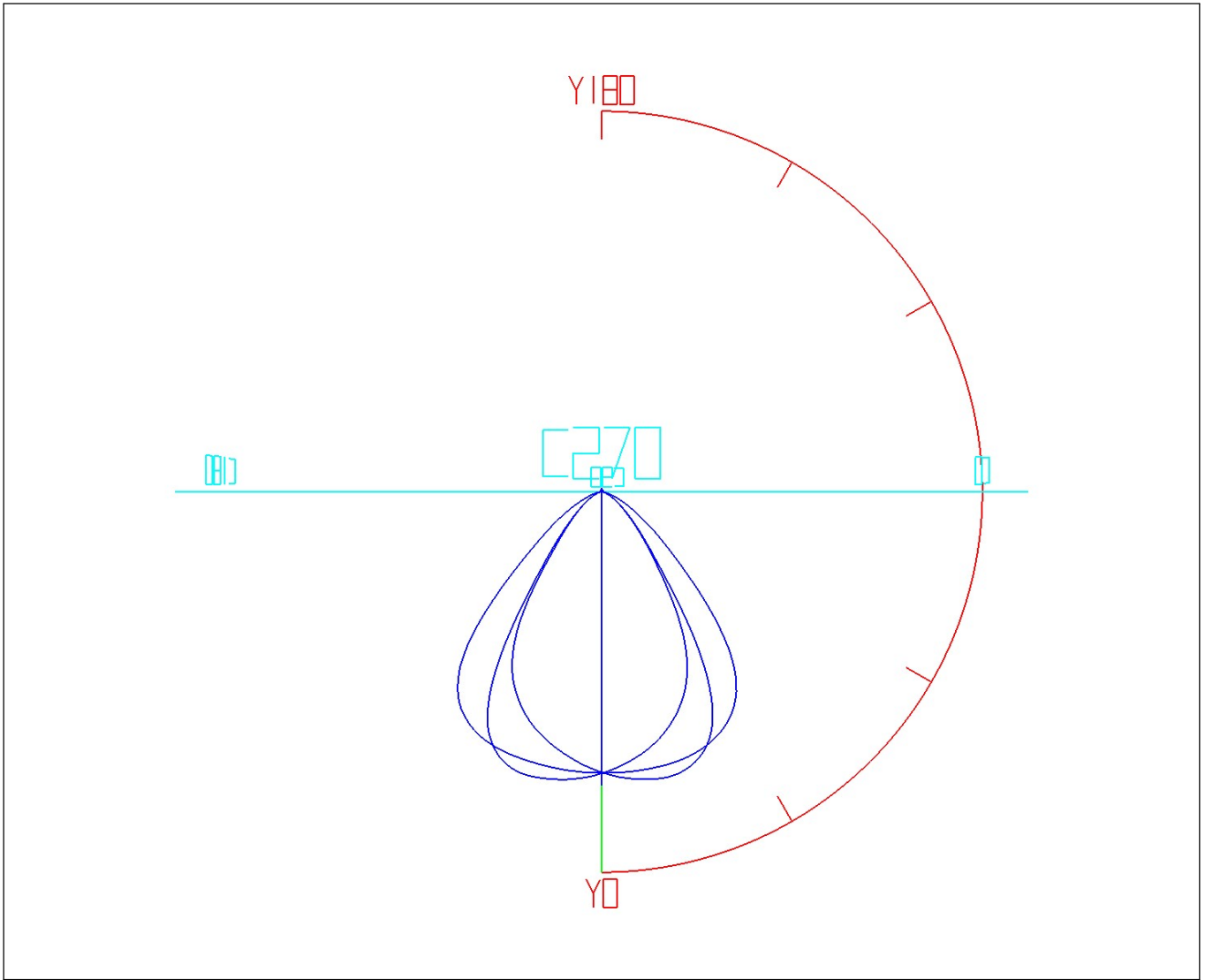

Curves: 3D Model ——— Fixture ——— Vert. HUD ——— Hori. HUD ———
View Angles: Orient:0 Tilt:0 Roll:0 Spin:0

IES Indoor Report
Photometric Filename:120W-6000K.ies

Zonal Flux Tabulation

Zone (γ)	Zone Flux (lm)	Sums Flux (lm)	Zone%Lamp	Sums%Lamp	Zone (γ)	Zone Flux (lm)	Sums Flux (lm)	Zone%Lamp	Sums%Lamp
0.0-1.0	9.42	9.42	0.05	0.05	47.0-48.0	316.39	16585.74	1.55	81.03
1.0-2.0	28.27	37.69	0.14	0.18	48.0-49.0	293.69	16879.44	1.43	82.47
2.0-3.0	47.11	84.80	0.23	0.41	49.0-50.0	273.75	17153.19	1.34	83.80
3.0-4.0	65.92	150.72	0.32	0.74	50.0-51.0	254.57	17407.75	1.24	85.05
4.0-5.0	84.70	235.42	0.41	1.15	51.0-52.0	237.06	17644.81	1.16	86.21
5.0-6.0	103.45	338.87	0.51	1.66	52.0-53.0	221.17	17865.98	1.08	87.29
6.0-7.0	122.14	461.02	0.60	2.25	53.0-54.0	205.71	18071.69	1.01	88.29
7.0-8.0	140.78	601.80	0.69	2.94	54.0-55.0	191.49	18263.17	0.94	89.23
8.0-9.0	159.36	761.16	0.78	3.72	55.0-56.0	177.78	18440.95	0.87	90.10
9.0-10.0	177.87	939.03	0.87	4.59	56.0-57.0	164.75	18605.70	0.80	90.90
10.0-11.0	196.29	1135.33	0.96	5.55	57.0-58.0	153.23	18758.93	0.75	91.65
11.0-12.0	214.63	1349.96	1.05	6.60	58.0-59.0	141.89	18900.82	0.69	92.34
12.0-13.0	232.89	1582.84	1.14	7.73	59.0-60.0	131.08	19031.90	0.64	92.98
13.0-14.0	251.02	1833.86	1.23	8.96	60.0-61.0	120.91	19152.82	0.59	93.57
14.0-15.0	269.02	2102.88	1.31	10.27	61.0-62.0	111.22	19264.04	0.54	94.12
15.0-16.0	286.88	2389.76	1.40	11.68	62.0-63.0	102.53	19366.57	0.50	94.62
16.0-17.0	304.56	2694.32	1.49	13.16	63.0-64.0	93.93	19460.51	0.46	95.08
17.0-18.0	322.08	3016.40	1.57	14.74	64.0-65.0	85.81	19546.32	0.42	95.50
18.0-19.0	339.32	3355.72	1.66	16.39	65.0-66.0	78.62	19624.94	0.38	95.88
19.0-20.0	356.29	3712.01	1.74	18.14	66.0-67.0	71.61	19696.55	0.35	96.23
20.0-21.0	372.97	4084.99	1.82	19.96	67.0-68.0	65.00	19761.55	0.32	96.55
21.0-22.0	389.23	4474.22	1.90	21.86	68.0-69.0	58.79	19820.35	0.29	96.83
22.0-23.0	405.07	4879.29	1.98	23.84	69.0-70.0	53.00	19873.34	0.26	97.09
23.0-24.0	420.44	5299.73	2.05	25.89	70.0-71.0	47.83	19921.17	0.23	97.33
24.0-25.0	435.26	5734.98	2.13	28.02	71.0-72.0	42.64	19963.81	0.21	97.54
25.0-26.0	449.56	6184.55	2.20	30.22	72.0-73.0	37.66	20001.48	0.18	97.72
26.0-27.0	463.10	6647.64	2.26	32.48	73.0-74.0	33.24	20034.72	0.16	97.88
27.0-28.0	475.92	7123.56	2.33	34.80	74.0-75.0	29.03	20063.75	0.14	98.02
28.0-29.0	488.02	7611.58	2.38	37.19	75.0-76.0	25.22	20088.97	0.12	98.15
29.0-30.0	498.95	8110.53	2.44	39.62	76.0-77.0	21.80	20110.77	0.11	98.25
30.0-31.0	508.77	8619.30	2.49	42.11	77.0-78.0	18.73	20129.50	0.09	98.34
31.0-32.0	517.30	9136.61	2.53	44.64	78.0-79.0	16.17	20145.67	0.08	98.42
32.0-33.0	524.37	9660.98	2.56	47.20	79.0-80.0	13.84	20159.51	0.07	98.49
33.0-34.0	529.98	10190.96	2.59	49.79	80.0-81.0	11.66	20171.17	0.06	98.55
34.0-35.0	532.92	10723.88	2.60	52.39	81.0-82.0	9.62	20180.79	0.05	98.60
35.0-36.0	533.44	11257.33	2.61	55.00	82.0-83.0	7.66	20188.44	0.04	98.63
36.0-37.0	531.62	11788.95	2.60	57.60	83.0-84.0	5.70	20194.14	0.03	98.66
37.0-38.0	526.32	12315.27	2.57	60.17	84.0-85.0	3.86	20198.01	0.02	98.68
38.0-39.0	518.11	12833.38	2.53	62.70	85.0-86.0	2.42	20200.42	0.01	98.69
39.0-40.0	505.69	13339.08	2.47	65.17	86.0-87.0	1.42	20201.84	0.01	98.70
40.0-41.0	489.55	13828.63	2.39	67.56	87.0-88.0	0.98	20202.82	0.00	98.70
41.0-42.0	470.56	14299.18	2.30	69.86	88.0-89.0	0.91	20203.74	0.00	98.71
42.0-43.0	447.02	14746.21	2.18	72.04	89.0-90.0	0.89	20204.63	0.00	98.71
43.0-44.0	421.15	15167.36	2.06	74.10	90.0-91.0	0.93	20205.56	0.00	98.72
44.0-45.0	394.23	15561.59	1.93	76.03	91.0-92.0	0.96	20206.53	0.00	98.72
45.0-46.0	366.76	15928.35	1.79	77.82	92.0-93.0	0.99	20207.52	0.00	98.73
46.0-47.0	341.01	16269.36	1.67	79.49	93.0-94.0	1.07	20208.59	0.01	98.73

IES Indoor Report
Photometric Filename:120W-6000K.ies

Zonal Flux Tabulation - (Cont.)

Zone (γ)	Zone Flux (lm)	Sums Flux (lm)	Zone%Lamp	Sums%Lamp	Zone (γ)	Zone Flux (lm)	Sums Flux (lm)	Zone%Lamp	Sums%Lamp
94.0-95.0	1.14	20209.73	0.01	98.74	141.0-142.0	4.49	20362.53	0.02	99.48
95.0-96.0	1.19	20210.92	0.01	98.74	142.0-143.0	4.47	20367.00	0.02	99.51
96.0-97.0	1.26	20212.18	0.01	98.75	143.0-144.0	4.43	20371.43	0.02	99.53
97.0-98.0	1.35	20213.53	0.01	98.76	144.0-145.0	4.40	20375.83	0.02	99.55
98.0-99.0	1.44	20214.97	0.01	98.76	145.0-146.0	4.37	20380.20	0.02	99.57
99.0-100.0	1.49	20216.46	0.01	98.77	146.0-147.0	4.34	20384.53	0.02	99.59
100.0-101.0	1.59	20218.04	0.01	98.78	147.0-148.0	4.29	20388.82	0.02	99.61
101.0-102.0	1.69	20219.74	0.01	98.79	148.0-149.0	4.23	20393.04	0.02	99.63
102.0-103.0	1.80	20221.53	0.01	98.79	149.0-150.0	4.17	20397.21	0.02	99.65
103.0-104.0	1.91	20223.44	0.01	98.80	150.0-151.0	4.11	20401.33	0.02	99.67
104.0-105.0	2.02	20225.46	0.01	98.81	151.0-152.0	4.05	20405.38	0.02	99.69
105.0-106.0	2.13	20227.59	0.01	98.82	152.0-153.0	3.98	20409.35	0.02	99.71
106.0-107.0	2.24	20229.83	0.01	98.83	153.0-154.0	3.90	20413.25	0.02	99.73
107.0-108.0	2.33	20232.16	0.01	98.85	154.0-155.0	3.82	20417.07	0.02	99.75
108.0-109.0	2.43	20234.59	0.01	98.86	155.0-156.0	3.74	20420.82	0.02	99.77
109.0-110.0	2.53	20237.12	0.01	98.87	156.0-157.0	3.65	20424.47	0.02	99.79
110.0-111.0	2.62	20239.74	0.01	98.88	157.0-158.0	3.56	20428.04	0.02	99.80
111.0-112.0	2.73	20242.47	0.01	98.90	158.0-159.0	3.47	20431.51	0.02	99.82
112.0-113.0	2.87	20245.33	0.01	98.91	159.0-160.0	3.36	20434.87	0.02	99.84
113.0-114.0	2.99	20248.32	0.01	98.93	160.0-161.0	3.25	20438.12	0.02	99.85
114.0-115.0	3.08	20251.40	0.02	98.94	161.0-162.0	3.14	20441.26	0.02	99.87
115.0-116.0	3.16	20254.56	0.02	98.96	162.0-163.0	3.02	20444.28	0.01	99.88
116.0-117.0	3.26	20257.82	0.02	98.97	163.0-164.0	2.90	20447.18	0.01	99.90
117.0-118.0	3.39	20261.22	0.02	98.99	164.0-165.0	2.77	20449.95	0.01	99.91
118.0-119.0	3.50	20264.72	0.02	99.01	165.0-166.0	2.63	20452.59	0.01	99.92
119.0-120.0	3.61	20268.33	0.02	99.02	166.0-167.0	2.49	20455.07	0.01	99.94
120.0-121.0	3.68	20272.01	0.02	99.04	167.0-168.0	2.34	20457.41	0.01	99.95
121.0-122.0	3.77	20275.78	0.02	99.06	168.0-169.0	2.18	20459.60	0.01	99.96
122.0-123.0	3.87	20279.66	0.02	99.08	169.0-170.0	2.02	20461.62	0.01	99.97
123.0-124.0	3.95	20283.60	0.02	99.10	170.0-171.0	1.85	20463.48	0.01	99.98
124.0-125.0	4.02	20287.63	0.02	99.12	171.0-172.0	1.67	20465.15	0.01	99.98
125.0-126.0	4.09	20291.72	0.02	99.14	172.0-173.0	1.50	20466.65	0.01	99.99
126.0-127.0	4.17	20295.89	0.02	99.16	173.0-174.0	1.31	20467.96	0.01	100.00
127.0-128.0	4.25	20300.14	0.02	99.18	174.0-175.0	1.12	20469.08	0.01	100.00
128.0-129.0	4.28	20304.43	0.02	99.20	175.0-176.0	0.92	20470.00	0.00	100.01
129.0-130.0	4.32	20308.75	0.02	99.22	176.0-177.0	0.72	20470.72	0.00	100.01
130.0-131.0	4.37	20313.12	0.02	99.24	177.0-178.0	0.52	20471.24	0.00	100.01
131.0-132.0	4.41	20317.53	0.02	99.26	178.0-179.0	0.31	20471.55	0.00	100.02
132.0-133.0	4.46	20321.99	0.02	99.29	179.0-180.0	0.10	20471.65	0.00	100.02
133.0-134.0	4.48	20326.48	0.02	99.31					
134.0-135.0	4.50	20330.98	0.02	99.33					
135.0-136.0	4.53	20335.51	0.02	99.35					
136.0-137.0	4.52	20340.03	0.02	99.37					
137.0-138.0	4.51	20344.54	0.02	99.40					
138.0-139.0	4.51	20349.05	0.02	99.42					
139.0-140.0	4.50	20353.55	0.02	99.44					
140.0-141.0	4.49	20358.04	0.02	99.46					

Rectangle ISO Lighting Intensity Diagram

Lum. Name: PLUTOHB 120W 6000K	Lum. Catalog:	Test ID: adm
Lamp Name:	Lamp Catalog:	Test Lab:
Manufacture: Eurotech Lighting Ltd	Test Machine:	Test Date: 2024-04-10

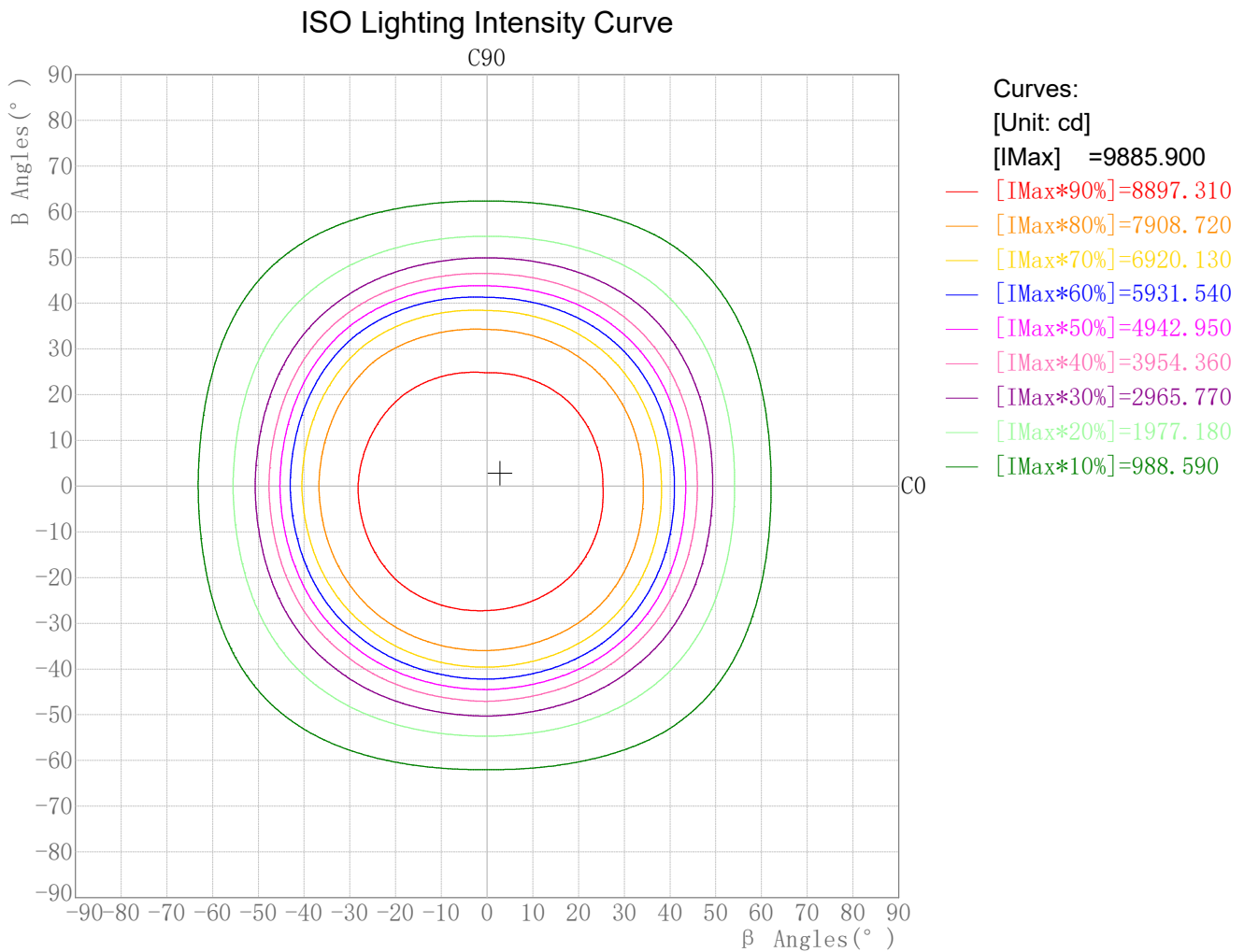

Maximum Light Intensity(cd): 9885.90
Maximum Cand.@Angle: H=2.8°,V=2.8°

Plane ISO-Illuminance Diagram

Lum. Name: PLUTOHB 120W 6000K	Lum. Catalog:	Test ID: adm
Lamp Name:	Lamp Catalog:	Test Lab:
Manufacture: Eurotech Lighting Ltd	Test Machine:	Test Date: 2024-04-10

Plane ISO-Illuminance Curve

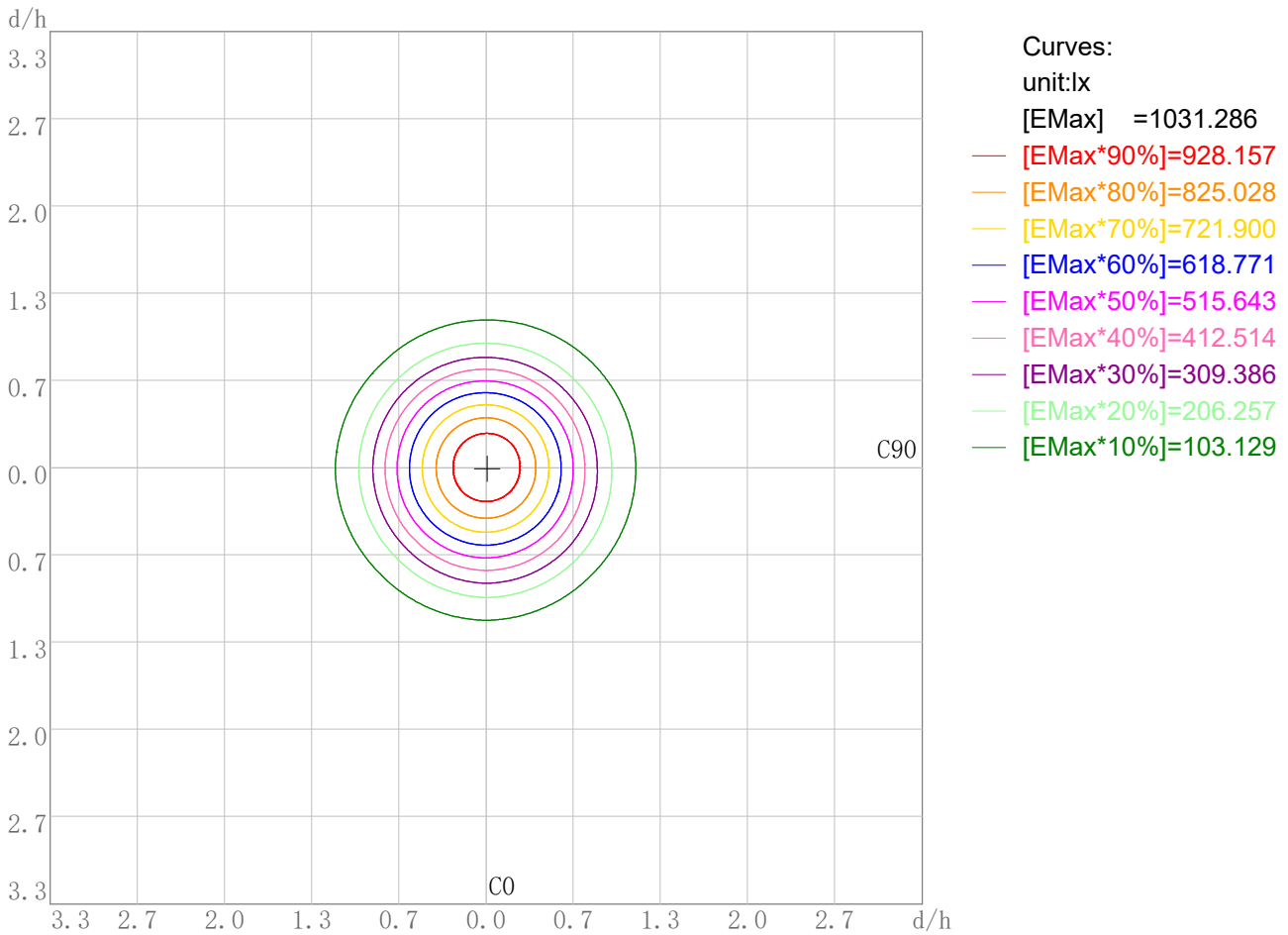

Working Plane Luminaire Mounting Height(m): 3.00
 Working Plane Maximum Illuminance(lx): 1031.29
 Working Plane Maximum Illuminance Position(d/h):H0.0 V0.0

3D Plane ISO Illuminance Diagram

Lum. Name: PLUTOHB 120W 6000K	Lum. Catalog:	Test ID: adm1
Lamp Name:	Lamp Catalog:	Test Lab:
Manufacture: Eurotech Lighting Ltd	Test Machine:	Test Date: 2024-04-10

3D Plane Illuminance Modal

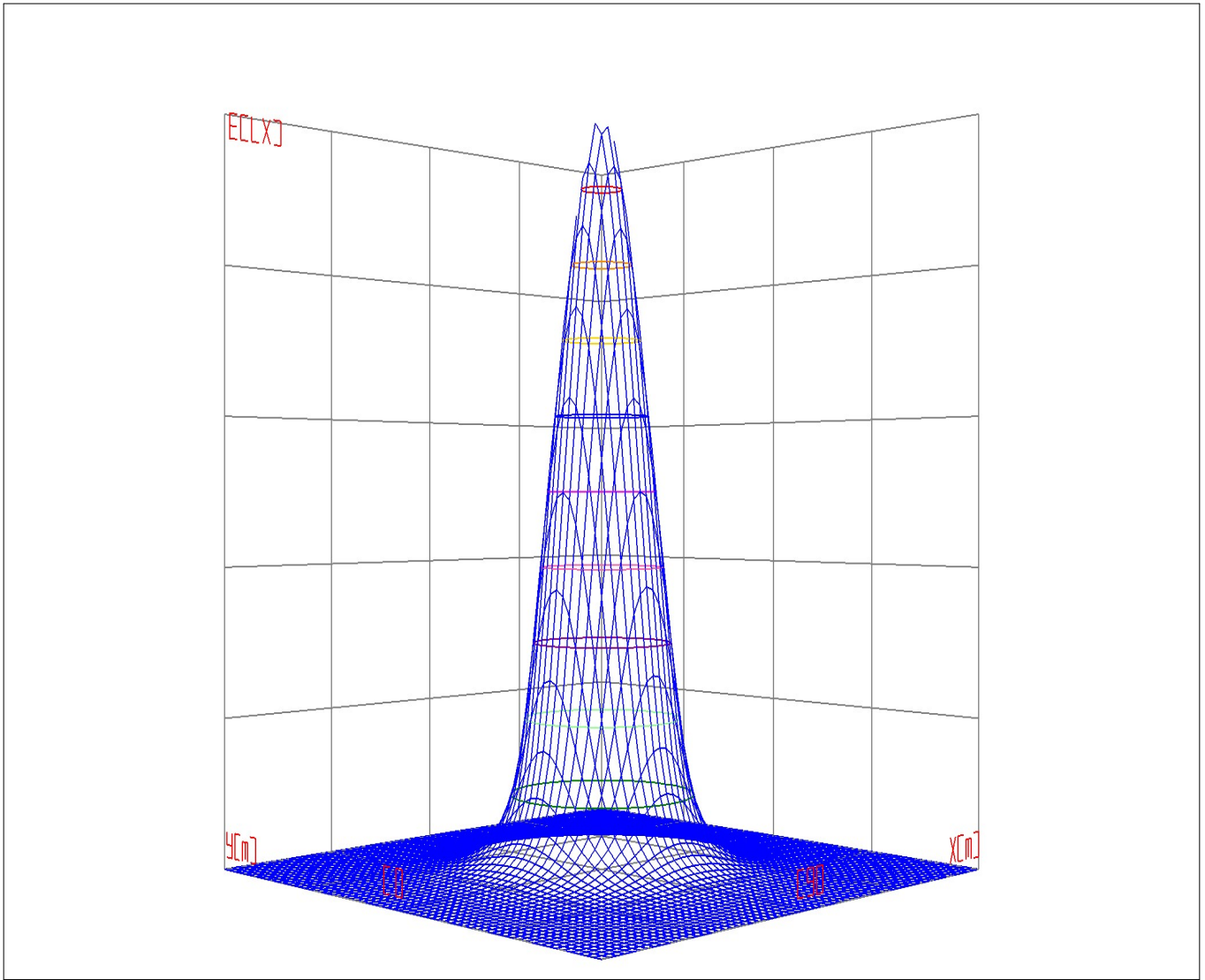

Curves: 3D Model — 90% — 80% — 70% — 60% — 50% — 40% — 30% — 20% — 10% —
View Angles(deg): 0 Height(m): 3.0 Distance(m): 10.0

Space ISO Illuminance Diagram

Lum. Name: PLUTOHB 120W 6000K	Lum. Catalog:	Test ID: adm
Lamp Name:	Lamp Catalog:	Test Lab:
Manufacture: Eurotech Lighting Ltd	Test Machine:	Test Date: 2024-04-10

Space ISO Illuminance Curve

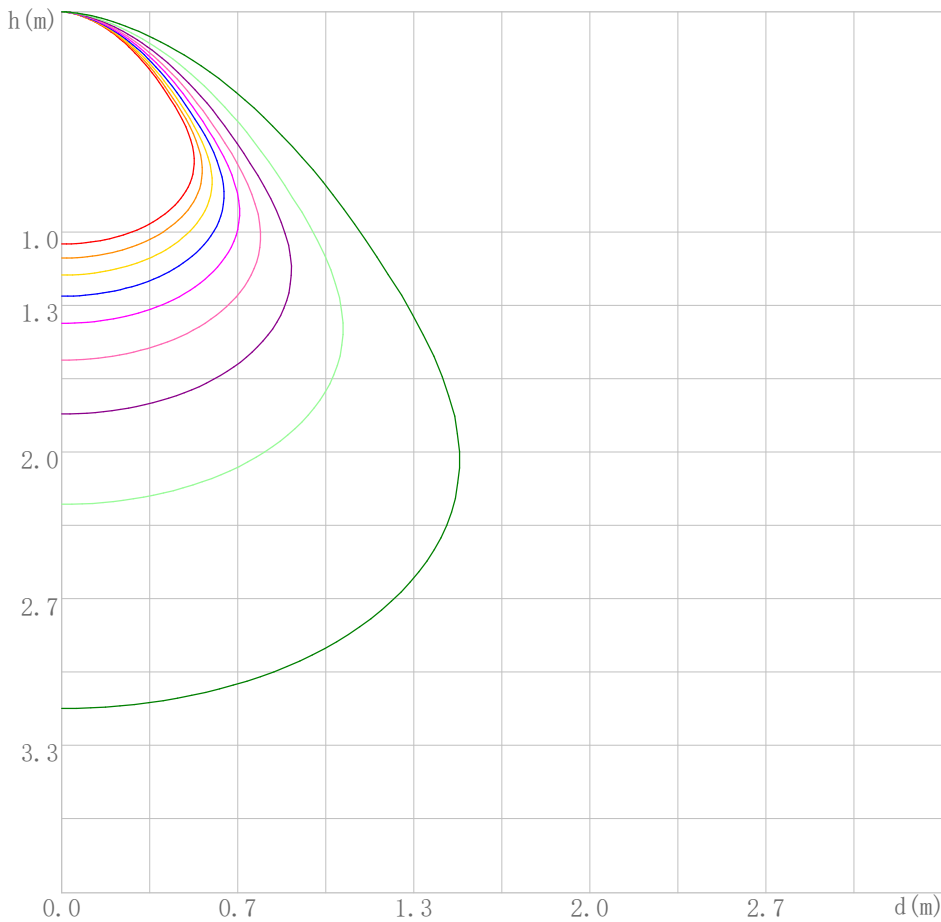

- Curves:
 [Unit: lx]
 [EMax] =9860.865
- [EMax*90%]=8874.779
 - [EMax*80%]=7888.692
 - [EMax*70%]=6902.606
 - [EMax*60%]=5916.519
 - [EMax*50%]=4930.433
 - [EMax*40%]=3944.346
 - [EMax*30%]=2958.260
 - [EMax*20%]=1972.173
 - [EMax*10%]=986.087

Space Plane Maximum Illuminance and @Angle:9860.87lx,0.0deg
 Plane Maximum Lighting Intensity and @Angle:9866.535cd,0deg

Illuminance-Distance Diagram

Lum. Name: PLUTOHB 120W 6000K	Lum. Catalog:	Test ID: admi
Lamp Name:	Lamp Catalog:	Test Lab:
Manufacture: Eurotech Lighting Ltd	Test Machine:	Test Date: 2024-04-10

Illuminance-Distance Curve

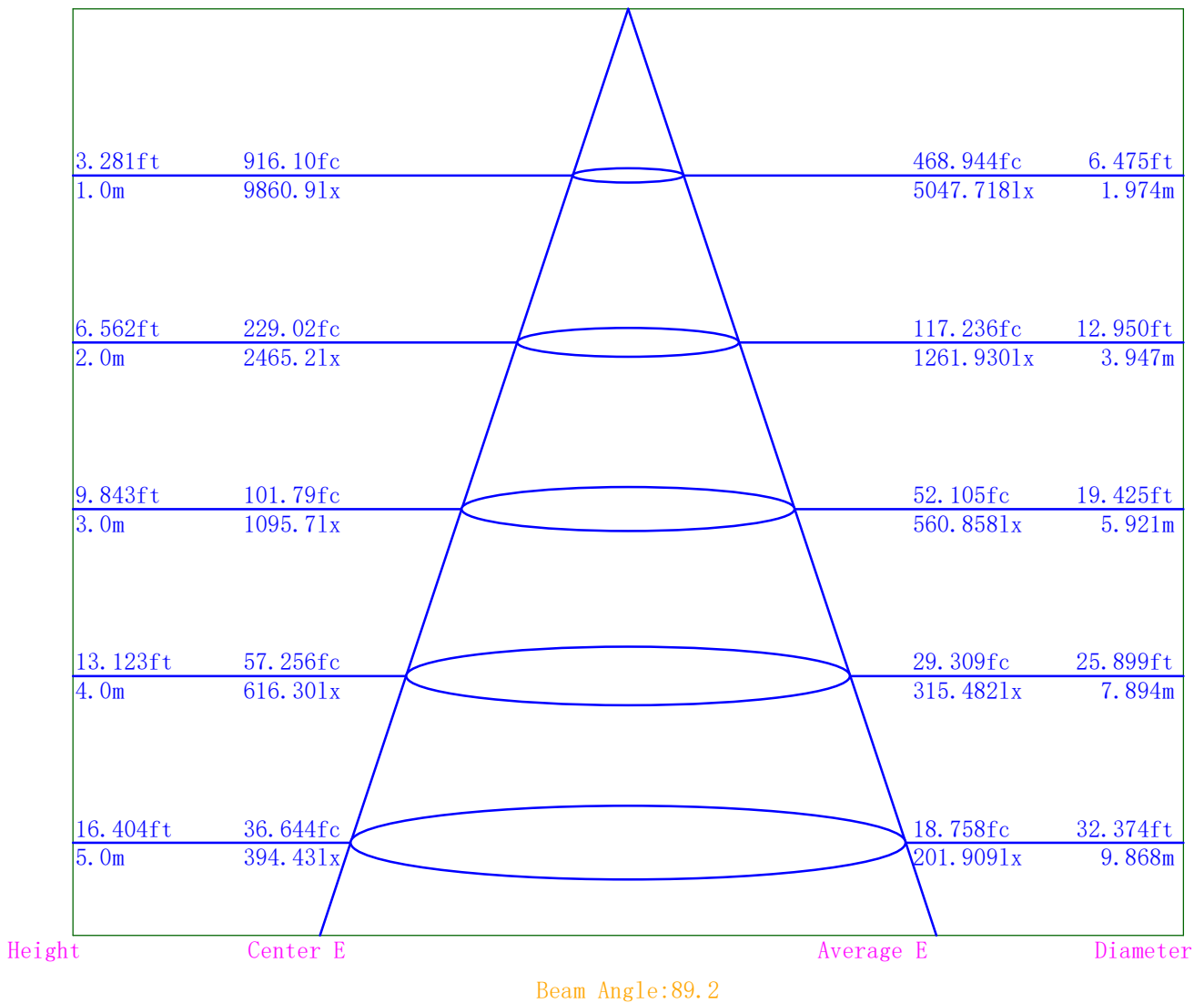

Indoor Luminance Limiting Curves

Lum. Name: PLUTOHB 120W 6000K	Lum. Catalog:	Test ID: adm1
Lamp Name:	Lamp Catalog:	Test Lab:
Manufacture: Eurotech Lighting Ltd	Test Machine:	Test Date: 2024-04-10

Glare Grade Table

GI	Quality	Using Illuminance							
		a	b	c	d	e	f	g	h
1.15	A	2000	1000	500	<=300				
1.5	B		2000	1000	500	<=300			
1.85	C			2000	1000	500	<=300		
2.2	D				2000	1000	500	<=300	
2.55	E	a				2000	1000	500	<=300
			b	c	d	e	f	g	h

Luminance Table

Gama (deg)	45	50	55	60	65	70	75	80	85
C0	0	0	0	0	0	0	0	0	0
C90	0	0	0	0	0	0	0	0	0

Luminance Limiting Curve

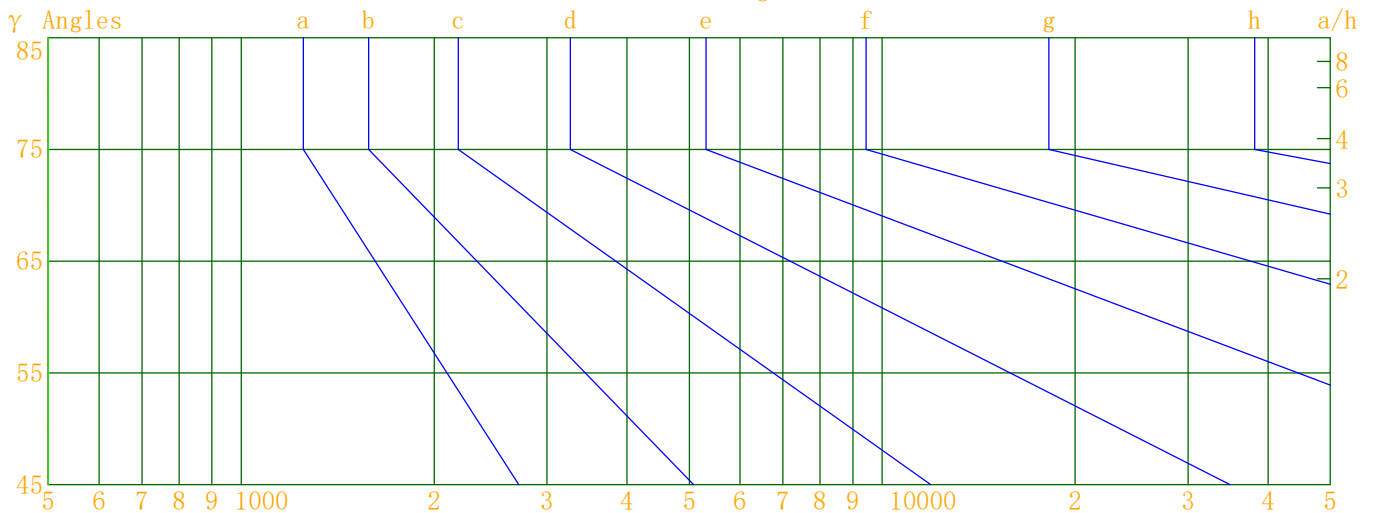

Luminous Size: Length(m)=0.000 Width(m)=0.000 Height(m)=0.000 Area(m²)=0.000000
 Luminous Type: Without Luminous Side
 Luminous Curves: C0-C180 Color: — C90-C270 Color: —

Indoor Budgetary Estimate Table

Lum. Name: PLUTOHB 120W 6000K	Lum. Catalog:	Test ID: adm
Lamp Name:	Lamp Catalog:	Test Lab:
Manufacture: Eurotech Lighting Ltd	Test Machine:	Test Date: 2024-04-10

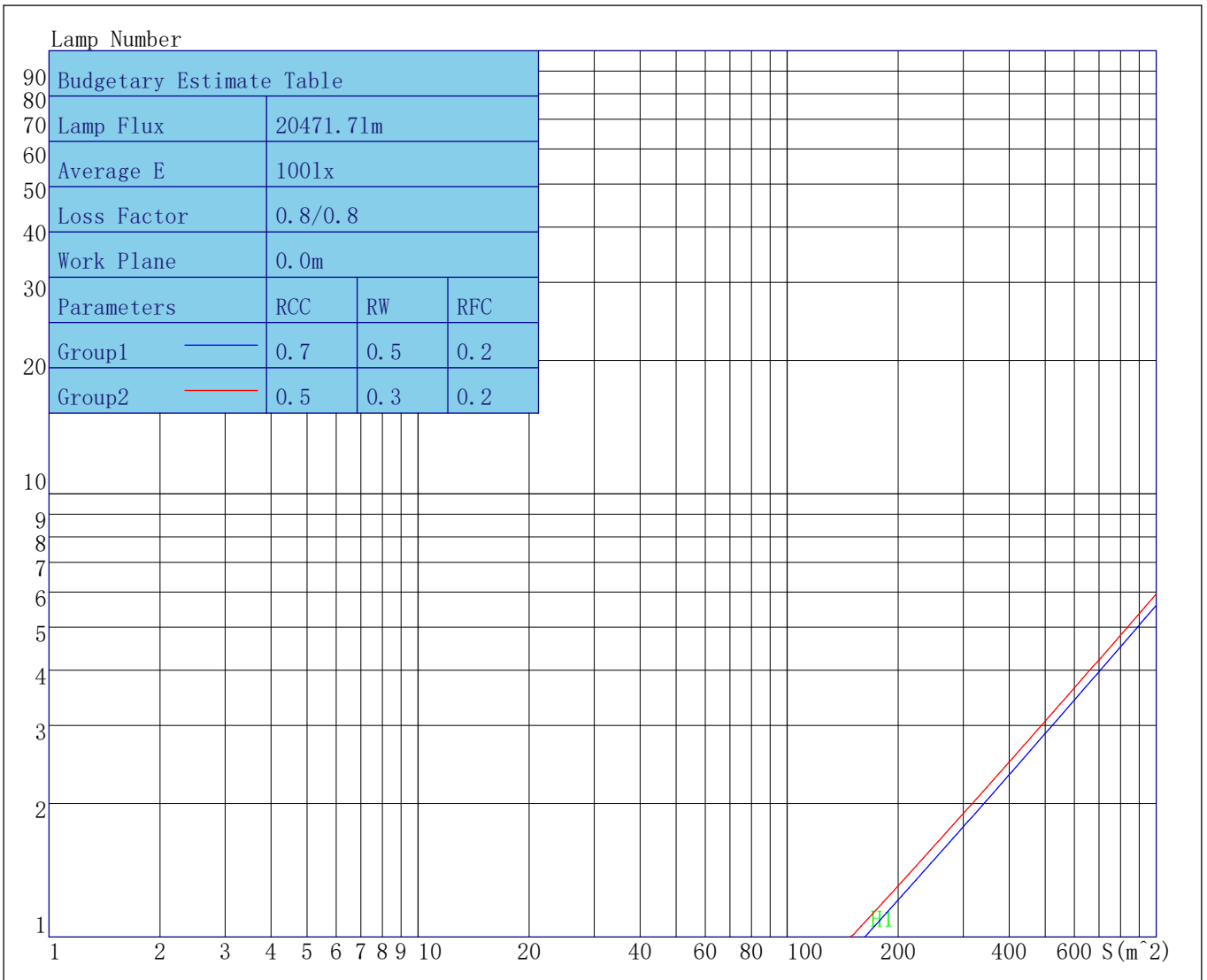

Parameters1: Rhocc = 0.7 Rhow = 0.5 Rhofc = 0.2 LLF = 0.8
Parameters2: Rhocc = 0.5 Rhow = 0.3 Rhofc = 0.2 LLF = 0.8
Average Illuminance(lx): 100 Cavity Height: H1(m) = 2

Indoor Coefficient of Utilization Table

Lum. Name: PLUTOHB 120W 6000K	Lum. Catalog:	Test ID: admi
Lamp Name:	Lamp Catalog:	Test Lab:
Manufacture: Eurotech Lighting Ltd	Test Machine:	Test Date: 2024-04-10

Coefficients of Utilization - Zonal Cavity Method																					
Coef.	Effective Floor Cavity Reflectance RFC=0.20																				
RhoCC (%)	80				70				50				30				10				0
RhoW (%)	70	50	30	10	70	50	30	10	50	30	10	50	30	10	50	30	10	50	30	10	0
RCR	Coefficient of Utilization (%)																				
0	119	119	119	119	116	116	116	116	110	110	110	105	105	105	101	101	101	99			
1	111	108	104	102	109	105	102	100	101	99	96	97	95	93	93	92	90	88			
2	103	97	92	87	101	95	90	86	92	88	84	88	85	82	85	82	80	78			
3	96	88	81	76	94	86	80	75	83	78	74	80	76	72	78	74	71	69			
4	89	79	72	67	87	78	71	66	76	70	65	73	68	64	71	67	63	61			
5	83	72	65	59	81	71	64	59	69	63	58	67	61	57	65	60	57	55			
6	77	66	58	53	75	65	58	52	63	57	52	61	56	51	60	55	51	49			
7	72	60	53	47	70	60	52	47	58	51	47	57	51	46	55	50	46	44			
8	67	56	48	43	66	55	48	43	53	47	42	52	46	42	51	46	42	40			
9	63	51	44	39	62	51	44	39	49	43	39	48	43	38	47	42	38	36			
10	59	48	40	36	58	47	40	35	46	40	35	45	39	35	44	39	35	33			

IES Indoor Report
Photometric Filename:120W-6000K.ies

Unified Glare Rating Table

Lum. Name: PLUTOHB 120W 6000K	Lum. Catalog:	Test ID: admi
Lamp Name:	Lamp Catalog:	Test Lab:
Manufacture: Eurotech Lighting Ltd	Test Machine:	Test Date: 2024-04-10

Unified Glare Rating Table

Ceiling RCC	0.70	0.70	0.50	0.50	0.30	0.70	0.70	0.50	0.50	0.30	
Wall RW	0.50	0.30	0.50	0.30	0.30	0.50	0.30	0.50	0.30	0.30	
Floor RFC	0.20	0.20	0.20	0.20	0.20	0.20	0.20	0.20	0.20	0.20	
Room Size	Vewed crosswise					Vewed endwise					
X=2H	Y=2H	9.1	10.4	9.5	10.8	11.1	9.1	10.4	9.5	10.8	11.1
	Y=3H	9.0	10.1	9.4	10.5	10.9	9.0	10.1	9.4	10.5	10.9
	Y=4H	8.9	10.0	9.3	10.4	10.8	8.9	10.0	9.3	10.4	10.8
	Y=6H	8.8	9.8	9.3	10.2	10.6	8.8	9.8	9.3	10.2	10.6
	Y=8H	8.8	9.7	9.2	10.1	10.6	8.8	9.7	9.2	10.1	10.6
	Y=12H	8.7	9.6	9.2	10.0	10.5	8.7	9.6	9.2	10.0	10.5
X=4H	Y=2H	8.9	10.0	9.3	10.4	10.8	8.9	10.0	9.3	10.4	10.8
	Y=3H	8.8	9.6	9.2	10.1	10.5	8.8	9.6	9.2	10.1	10.5
	Y=4H	8.7	9.4	9.1	9.9	10.4	8.7	9.4	9.1	9.9	10.4
	Y=6H	8.6	9.3	9.1	9.7	10.2	8.6	9.3	9.1	9.7	10.2
	Y=8H	8.5	9.2	9.0	9.6	10.1	8.5	9.2	9.0	9.6	10.1
	Y=12H	8.5	9.0	9.0	9.5	10.0	8.5	9.0	9.0	9.5	10.0
X=8H	Y=4H	8.5	9.2	9.0	9.6	10.1	8.5	9.2	9.0	9.6	10.1
	Y=6H	8.4	8.9	9.0	9.5	10.0	8.4	8.9	9.0	9.5	10.0
	Y=8H	8.4	8.8	8.9	9.4	9.9	8.4	8.8	8.9	9.4	9.9
	Y=12H	8.3	8.7	8.9	9.2	9.8	8.3	8.7	8.9	9.2	9.8
X=12H	Y=4H	8.5	9.0	9.0	9.5	10.0	8.5	9.0	9.0	9.5	10.0
	Y=6H	8.4	8.8	8.9	9.3	9.9	8.4	8.8	8.9	9.3	9.9
	Y=8H	8.3	8.7	8.9	9.2	9.8	8.3	8.7	8.9	9.2	9.8
Variations with the objverer position at spacings											
S=1.0H	0.0/0.0					0.0/0.0					
S=1.5H	0.0/0.0					0.0/0.0					
S=2.0H	0.0/0.0					0.0/0.0					
Reduced UGR Table:											
Nordic Standard Table:	BKO					BKO					
Correction Value	0.0					0.0					

o the CIE Pub. 117, data has been corrected, refers to the lamp's lumens 8.2flm.

IES Indoor Report
Photometric Filename:120W-6000K.ies

Candela Tabulation

V/H	C0.0	C45.0	C90.0	C135.0	C180.0	C225.0	C270.0	C315.0
γ 0.0	9860.87	9875.55	9816.13	9837.16	9860.87	9875.55	9816.13	9837.16
γ 1.0	9864.21	9877.89	9818.13	9838.50	9859.86	9871.88	9814.46	9837.50
γ 2.0	9863.87	9879.89	9821.15	9838.83	9860.54	9872.55	9813.79	9838.17
γ 3.0	9866.54	9881.89	9819.48	9836.16	9856.52	9868.21	9812.13	9836.83
γ 4.0	9866.54	9885.90	9819.48	9835.50	9854.18	9862.54	9807.79	9837.16
γ 5.0	9866.54	9885.56	9819.80	9832.83	9848.84	9855.85	9803.45	9836.50
γ 6.0	9865.87	9885.56	9818.80	9831.16	9843.84	9850.51	9799.44	9833.49
γ 7.0	9863.20	9883.56	9814.79	9826.15	9842.50	9844.84	9794.77	9830.16
γ 8.0	9861.87	9881.89	9813.79	9820.13	9836.50	9840.84	9790.10	9825.48
γ 9.0	9859.52	9880.22	9810.46	9815.80	9828.49	9836.16	9782.42	9823.15
γ 10.0	9856.19	9877.56	9807.45	9810.79	9823.15	9830.16	9778.08	9819.13
γ 11.0	9851.51	9873.88	9802.78	9807.12	9814.79	9821.48	9773.40	9813.13
γ 12.0	9847.51	9870.21	9798.78	9801.78	9807.12	9813.46	9765.39	9811.12
γ 13.0	9843.51	9865.21	9795.44	9797.11	9800.11	9805.12	9762.39	9807.45
γ 14.0	9834.83	9856.85	9787.10	9789.10	9790.77	9796.11	9755.38	9801.45
γ 15.0	9824.82	9845.51	9779.42	9782.42	9783.76	9789.10	9754.05	9795.77
γ 16.0	9812.13	9827.15	9767.40	9774.07	9775.75	9781.09	9747.04	9787.76
γ 17.0	9798.11	9807.79	9752.71	9766.06	9768.73	9774.75	9740.36	9778.42
γ 18.0	9778.42	9788.76	9735.01	9754.05	9760.72	9769.40	9732.36	9767.73
γ 19.0	9749.71	9762.06	9710.65	9738.36	9750.38	9761.06	9720.33	9750.38
γ 20.0	9721.67	9732.36	9682.61	9722.33	9739.70	9751.04	9707.98	9731.68
γ 21.0	9686.95	9695.64	9650.91	9703.64	9724.67	9738.03	9692.29	9707.98
γ 22.0	9644.22	9650.57	9608.18	9676.60	9704.65	9720.66	9669.93	9677.27
γ 23.0	9603.83	9603.50	9563.45	9647.24	9682.94	9697.97	9646.22	9643.55
γ 24.0	9546.09	9551.09	9510.37	9609.51	9655.24	9667.26	9612.52	9599.83
γ 25.0	9487.68	9495.02	9453.63	9565.79	9621.86	9631.21	9574.13	9557.77
γ 26.0	9425.58	9425.92	9391.88	9518.04	9584.48	9589.48	9533.74	9505.03
γ 27.0	9345.13	9344.80	9320.11	9455.63	9531.74	9539.41	9479.00	9440.61
γ 28.0	9263.02	9262.68	9239.99	9398.55	9479.67	9484.00	9422.25	9374.18
γ 29.0	9166.22	9169.56	9150.20	9326.78	9418.57	9416.24	9356.16	9298.40
γ 30.0	9054.73	9055.40	9039.71	9240.66	9340.46	9327.11	9274.71	9202.94
γ 31.0	8931.23	8936.57	8929.22	9149.87	9255.68	9234.99	9181.58	9103.80
γ 32.0	8787.02	8783.35	8785.02	9041.38	9156.54	9124.49	9072.42	8980.63
γ 33.0	8627.47	8622.12	8640.82	8926.55	9051.05	9002.99	8949.25	8843.10
γ 34.0	8448.54	8445.20	8470.58	8790.36	8920.20	8866.80	8807.05	8688.55
γ 35.0	8217.55	8211.55	8250.27	8622.12	8760.99	8683.54	8614.44	8481.26
γ 36.0	7992.57	7982.55	8035.30	8445.54	8581.73	8482.26	8410.15	8258.28
γ 37.0	7725.86	7719.18	7756.57	8213.22	8366.43	8230.24	8186.84	8015.27
γ 38.0	7401.07	7406.75	7486.19	7966.53	8130.10	7944.51	7903.45	7694.15
γ 39.0	7084.96	7093.98	7170.08	7696.82	7871.74	7621.05	7589.67	7372.70
γ 40.0	6675.72	6694.08	6807.57	7351.01	7530.92	7240.51	7213.14	6982.82
γ 41.0	6292.85	6325.57	6419.36	7007.51	7187.77	6838.62	6838.62	6575.57
γ 42.0	5877.60	5904.64	6031.82	6598.95	6786.87	6384.31	6417.69	6125.28
γ 43.0	5434.98	5465.01	5595.53	6137.63	6334.58	5888.94	5928.67	5629.58
γ 44.0	5009.05	5046.09	5177.62	5684.32	5876.93	5431.98	5487.38	5139.56
γ 45.0	4611.15	4675.91	4739.99	5159.25	5391.25	4921.58	5040.08	4672.91
γ 46.0	4188.89	4269.67	4378.83	4700.27	4944.95	4501.67	4609.48	4219.60

IES Indoor Report
Photometric Filename:120W-6000K.ies

Candela Tabulation - (Cont.)

V/H	C0. 0	C45. 0	C90. 0	C135. 0	C180. 0	C225. 0	C270. 0	C315. 0
γ 47. 0	3851. 41	3948. 89	4029. 67	4252. 65	4493. 65	4115. 46	4235. 28	3850. 74
γ 48. 0	3522. 29	3645. 46	3701. 87	3827. 38	4070. 06	3728. 91	3851. 41	3486. 57
γ 49. 0	3238. 55	3371. 07	3407. 79	3463. 53	3698. 53	3441. 84	3540. 64	3218. 86
γ 50. 0	2979. 86	3127. 06	3133. 74	3155. 10	3362. 39	3165. 45	3242. 56	2979. 19
γ 51. 0	2728. 17	2869. 70	2852. 01	2885. 06	3067. 65	2899. 41	2957. 49	2730. 17
γ 52. 0	2524. 55	2647. 39	2635. 71	2672. 76	2821. 30	2666. 09	2708. 81	2529. 22
γ 53. 0	2330. 28	2441. 10	2397. 70	2441. 10	2588. 31	2442. 76	2477. 15	2350. 64
γ 54. 0	2122. 65	2247. 16	2207. 44	2249. 83	2388. 02	2252. 50	2237. 82	2162. 38
γ 55. 0	1954. 75	2065. 91	2041. 20	2070. 58	2204. 44	2064. 90	2044. 21	2004. 48
γ 56. 0	1781. 51	1888. 99	1862. 96	1897. 67	2015. 83	1883. 98	1846. 59	1845. 93
γ 57. 0	1639. 30	1727. 43	1714. 41	1745. 79	1857. 95	1729. 77	1683. 36	1704. 40
γ 58. 0	1510. 79	1584. 23	1581. 89	1608. 26	1703. 06	1597. 24	1543. 50	1576. 55
γ 59. 0	1383. 61	1446. 03	1436. 02	1467. 73	1550. 51	1450. 37	1397. 97	1443. 36
γ 60. 0	1268. 12	1327. 53	1315. 52	1353. 91	1419. 66	1334. 54	1277. 46	1324. 19
γ 61. 0	1155. 29	1208. 36	1191. 34	1232. 73	1282. 80	1217. 72	1153. 29	1207. 36
γ 62. 0	1060. 49	1108. 56	1086. 20	1126. 58	1171. 32	1111. 56	1050. 15	1101. 88
γ 63. 0	966. 03	1006. 75	984. 72	1033. 45	1069. 17	1019. 10	959. 02	1010. 76
γ 64. 0	874. 90	912. 28	888. 25	936. 65	960. 35	917. 63	863. 21	911. 94
γ 65. 0	792. 79	831. 84	806. 47	853. 20	866. 88	835. 18	786. 43	833. 51
γ 66. 0	716. 01	758. 40	730. 02	771. 08	785. 43	760. 74	717. 68	760. 74
γ 67. 0	640. 90	685. 30	654. 25	695. 31	704. 33	682. 29	645. 24	685. 96
γ 68. 0	575. 80	621. 54	591. 83	631. 22	636. 23	618. 86	580. 15	616. 20
γ 69. 0	510. 05	553. 44	529. 74	561. 45	567. 46	555. 45	518. 73	551. 44
γ 70. 0	456. 98	501. 37	474. 67	505. 38	509. 05	501. 04	464. 65	494. 37
γ 71. 0	404. 56	451. 97	425. 93	450. 97	456. 64	446. 97	416. 59	441. 95
γ 72. 0	354. 50	397. 56	370. 86	393. 88	400. 23	392. 22	365. 18	390. 55
γ 73. 0	314. 10	350. 16	328. 80	344. 15	354. 50	340. 81	322. 46	342. 15
γ 74. 0	276. 05	302. 42	289. 08	294. 41	314. 10	298. 09	286. 41	300. 42
γ 75. 0	238. 67	258. 36	251. 02	251. 69	273. 38	259. 03	249. 02	254. 02
γ 76. 0	207. 29	220. 31	217. 97	218. 64	237. 00	229. 32	219. 64	214. 97
γ 77. 0	175. 58	188. 59	184. 92	187. 93	196. 61	199. 28	188. 26	184. 26
γ 78. 0	146. 87	161. 56	154. 55	165. 57	167. 90	177. 58	160. 56	159. 56
γ 79. 0	123. 84	138. 86	131. 85	145. 87	141. 53	155. 22	136. 86	139. 53
γ 80. 0	102. 81	119. 84	108. 49	128. 51	113. 83	131. 18	112. 50	122. 51
γ 81. 0	83. 12	104. 48	87. 46	113. 16	90. 46	110. 83	90. 13	105. 48
γ 82. 0	65. 10	88. 79	66. 76	96. 80	71. 77	87. 46	69. 43	88. 12
γ 83. 0	48. 73	73. 11	51. 74	79. 11	55. 74	65. 10	49. 73	69. 10
γ 84. 0	33. 05	58. 41	36. 39	58. 75	36. 72	41. 73	32. 71	47. 07
γ 85. 0	20. 36	38. 72	23. 04	35. 05	24. 37	27. 38	22. 04	30. 71
γ 86. 0	13. 68	25. 71	15. 35	23. 37	13. 02	11. 68	10. 01	19. 02
γ 87. 0	7. 68	14. 02	8. 34	11. 68	7. 01	9. 01	7. 01	10. 35
γ 88. 0	8. 34	10. 01	8. 34	10. 01	7. 01	8. 34	7. 01	9. 34
γ 89. 0	8. 34	8. 68	8. 34	8. 68	7. 34	8. 34	7. 01	8. 34
γ 90. 0	8. 34	8. 34	9. 01	9. 01	8. 01	7. 68	7. 34	7. 68
γ 91. 0	9. 34	8. 34	9. 68	8. 68	8. 01	9. 01	8. 01	9. 34
γ 92. 0	9. 01	9. 34	8. 68	9. 01	7. 68	9. 68	8. 34	8. 34
γ 93. 0	10. 35	9. 68	9. 68	10. 35	8. 01	9. 68	8. 34	9. 01

IES Indoor Report
Photometric Filename:120W-6000K.ies

Candela Tabulation - (Cont.)

V/H	C0.0	C45.0	C90.0	C135.0	C180.0	C225.0	C270.0	C315.0
γ 94.0	10.35	10.01	10.68	10.35	9.01	10.35	9.68	11.01
γ 95.0	11.01	11.01	10.68	11.01	10.68	11.01	10.01	10.01
γ 96.0	12.01	10.01	11.68	11.35	11.35	10.01	10.68	11.68
γ 97.0	13.02	12.01	12.01	11.68	11.35	11.35	11.68	12.68
γ 98.0	14.35	12.68	13.68	13.35	12.68	12.01	11.35	13.35
γ 99.0	14.35	13.68	13.68	13.68	13.02	13.68	12.68	13.68
γ 100.0	14.68	14.35	14.02	13.68	12.01	14.68	13.35	15.35
γ 101.0	16.69	15.35	15.69	15.35	13.35	15.69	14.68	16.35
γ 102.0	17.35	16.35	16.69	16.69	15.02	15.02	14.68	17.02
γ 103.0	18.35	18.02	17.69	17.35	16.02	18.35	16.02	17.69
γ 104.0	20.02	18.35	17.35	19.02	17.35	19.02	16.69	19.36
γ 105.0	21.69	18.69	19.69	20.36	18.02	20.02	17.69	20.69
γ 106.0	21.37	21.37	21.02	20.36	18.69	20.36	20.02	22.37
γ 107.0	23.37	22.04	23.04	21.37	20.69	20.36	21.37	23.37
γ 108.0	23.70	22.37	23.37	22.70	21.37	21.69	21.69	23.70
γ 109.0	25.37	24.71	23.70	24.37	23.04	23.04	23.37	25.04
γ 110.0	26.37	25.04	25.37	25.04	24.04	23.70	24.71	25.37
γ 111.0	28.04	25.71	27.04	25.71	24.37	25.71	25.37	26.37
γ 112.0	29.04	26.71	27.38	27.04	26.37	26.37	27.71	28.71
γ 113.0	30.71	29.38	29.71	30.38	27.71	27.38	28.71	29.38
γ 114.0	30.71	30.71	31.38	31.71	27.71	29.38	29.71	30.71
γ 115.0	32.71	31.71	32.05	32.71	28.38	31.05	31.05	32.38
γ 116.0	33.72	31.38	33.38	32.38	29.38	32.38	32.71	33.38
γ 117.0	35.05	35.05	34.38	34.38	31.71	33.72	33.72	35.38
γ 118.0	36.39	36.39	35.72	35.38	34.05	34.38	35.05	37.39
γ 119.0	37.72	37.05	37.72	37.05	36.39	35.72	37.05	38.39
γ 120.0	39.72	39.06	39.39	38.39	36.05	37.72	38.05	39.39
γ 121.0	40.39	40.06	40.72	38.72	37.05	39.39	39.06	40.06
γ 122.0	42.39	42.06	41.39	41.39	39.72	40.72	40.72	42.06
γ 123.0	42.73	42.73	43.06	42.39	41.06	42.06	43.06	42.73
γ 124.0	44.73	44.40	44.73	43.73	42.39	43.06	44.06	43.73
γ 125.0	45.73	46.40	45.40	43.39	44.40	44.06	45.40	46.73
γ 126.0	47.40	47.40	47.07	46.40	45.40	45.06	45.73	47.07
γ 127.0	49.07	48.73	50.07	47.73	47.40	46.73	47.73	48.07
γ 128.0	51.07	50.07	51.07	49.40	48.73	47.40	49.40	49.40
γ 129.0	51.74	51.40	51.07	49.73	49.07	48.73	50.40	50.07
γ 130.0	52.74	52.40	53.41	50.74	50.74	50.74	52.07	52.40
γ 131.0	54.41	53.41	54.41	52.40	51.74	50.74	53.41	53.41
γ 132.0	56.08	54.74	55.41	54.41	52.74	52.40	54.74	54.41
γ 133.0	56.74	56.41	57.41	55.74	54.74	55.07	56.41	55.41
γ 134.0	57.41	57.08	57.41	57.08	56.41	55.41	56.41	56.41
γ 135.0	59.41	58.75	59.41	58.41	58.08	57.41	57.74	58.08
γ 136.0	60.75	59.41	60.75	58.41	59.08	58.41	59.75	59.08
γ 137.0	61.42	60.41	60.75	60.08	60.41	59.08	60.08	60.08
γ 138.0	62.42	62.08	62.42	61.08	60.41	60.41	62.08	61.08
γ 139.0	64.43	62.75	64.10	62.42	61.42	60.75	63.08	62.08
γ 140.0	65.10	63.43	64.76	63.08	63.08	62.08	63.43	64.10

IES Indoor Report
Photometric Filename:120W-6000K.ies

Candela Tabulation - (Cont.)

V/H	C0.0	C45.0	C90.0	C135.0	C180.0	C225.0	C270.0	C315.0
γ 141.0	66.76	65.10	66.76	64.43	64.10	64.10	65.43	64.76
γ 142.0	66.43	66.43	67.77	65.76	65.43	65.43	67.43	66.43
γ 143.0	68.77	67.10	69.10	67.43	66.43	66.43	67.77	66.43
γ 144.0	69.77	68.43	69.43	68.10	68.10	67.77	69.10	67.43
γ 145.0	71.10	69.77	69.43	68.43	68.77	69.43	70.77	69.10
γ 146.0	72.44	70.77	71.77	69.77	70.10	70.77	71.44	71.44
γ 147.0	74.44	72.44	72.44	72.10	70.77	71.44	72.77	71.77
γ 148.0	74.44	73.44	72.77	73.11	72.44	72.77	73.77	73.11
γ 149.0	75.44	74.44	75.11	73.11	73.44	73.77	75.44	73.44
γ 150.0	76.44	75.78	75.44	75.44	74.77	75.44	76.11	74.77
γ 151.0	78.45	77.11	77.11	76.11	75.78	76.44	77.44	76.44
γ 152.0	79.11	78.45	78.78	76.44	77.11	77.44	78.11	77.44
γ 153.0	80.45	80.11	80.11	78.11	78.45	78.45	79.45	78.45
γ 154.0	80.78	80.11	80.78	81.45	78.78	80.45	80.11	79.45
γ 155.0	82.45	81.78	82.45	81.45	80.78	81.78	81.78	81.11
γ 156.0	82.78	82.78	83.45	83.45	81.78	82.45	83.45	83.12
γ 157.0	85.79	84.45	85.12	84.12	83.45	83.12	84.45	83.12
γ 158.0	86.45	85.45	86.45	85.45	85.12	84.45	86.12	85.79
γ 159.0	88.46	87.46	88.12	87.12	85.79	86.12	86.45	86.79
γ 160.0	89.46	88.12	88.46	87.12	87.12	86.79	88.79	88.46
γ 161.0	92.13	90.46	90.46	89.79	87.79	88.46	88.12	89.12
γ 162.0	93.13	90.46	91.79	92.13	90.13	89.79	90.79	90.79
γ 163.0	93.80	92.13	93.46	92.46	91.46	91.13	91.46	92.13
γ 164.0	95.47	93.80	95.13	94.13	92.80	92.13	92.80	93.46
γ 165.0	96.47	95.13	96.80	96.13	94.13	94.46	94.80	95.13
γ 166.0	97.47	95.80	97.80	97.13	95.80	95.80	95.13	96.80
γ 167.0	98.47	97.80	98.13	98.47	97.80	98.13	96.47	97.80
γ 168.0	99.80	98.80	101.14	99.47	98.80	99.47	98.80	98.13
γ 169.0	100.80	99.80	101.81	100.80	99.80	100.14	100.14	100.14
γ 170.0	102.81	102.14	103.47	102.81	101.47	101.14	101.47	101.81
γ 171.0	102.47	103.14	103.14	103.47	102.81	102.47	101.47	102.81
γ 172.0	104.14	103.81	105.81	104.81	104.14	102.47	103.47	102.47
γ 173.0	105.48	105.14	106.49	105.48	104.81	104.14	105.14	104.14
γ 174.0	106.14	106.49	106.49	106.14	105.81	105.81	106.81	104.81
γ 175.0	107.16	106.49	108.16	108.16	106.49	106.14	107.82	105.81
γ 176.0	108.16	106.14	107.16	108.49	107.49	106.81	107.49	107.49
γ 177.0	108.16	107.16	109.16	107.49	107.82	107.49	109.49	107.82
γ 178.0	108.16	107.49	109.49	108.82	108.16	107.49	109.16	107.82
γ 179.0	109.16	109.49	110.16	108.49	109.16	107.16	109.83	108.49
γ 180.0	109.49	109.16	110.83	109.49	109.49	108.16	110.16	109.16