

# Glow - Spotlight

## Model: Glow

### Installation Instructions

All installations must be carried out by a qualified electrician following local regulations. Make sure that the power is switched off before installation. Please read and follow the 'Installation instructions' and 'Safety instructions' sections carefully before commencing installation.

Installation of this model can change from time to time please read instructions every time before installation. For detailed specification, please go to our website [eurotechlighting.co.nz](http://eurotechlighting.co.nz)

Code:	Colour:	IP Rating:	Kelvins:	Lumens:	Material:	Voltage:	Wattage:
GLOW-3-CO	Copper	IP20	3000K	320lm per head	Iron & Acrylic	230V	6W per head
GLOW-3-CH	Chrome						

#### Product Information

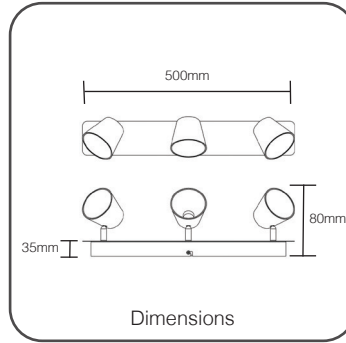
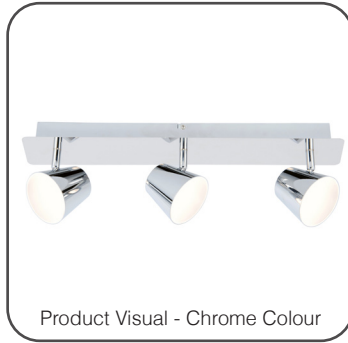
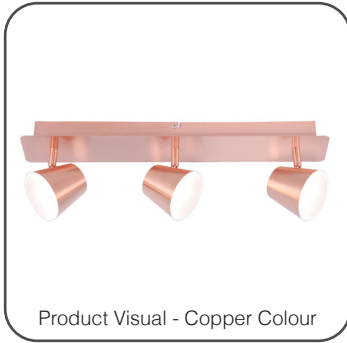

#### Installation Instructions

1. Make sure power is turned off. Unscrew screws at top.
2. Gently knock the provided plastic expansion tubes provided into the pre-drilled holes, ensuring the plastic tubes are flush with the mounting surface.
3. Mount metal backplate to the mounting surface. Fitting can be surface mounted on walls or ceiling.
4. Looking at the back of the fitting connect the wires leading from the LED luminaire, ensuring the relevant colour wires match each other. Connect your mains power wires, following the same colour sequencing.  
Blue = Negative, Brown = Positive & Yellow / Green = Earth
5. Once all wires are connected. Place your LED luminaire into place & reattach screws at the side of the fitting.
6. Ensure installation is correct before switching on the fitting to test.

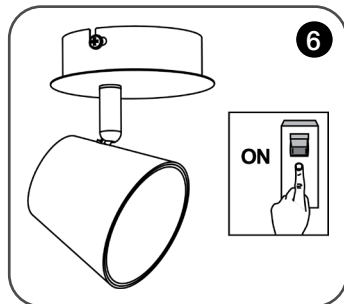
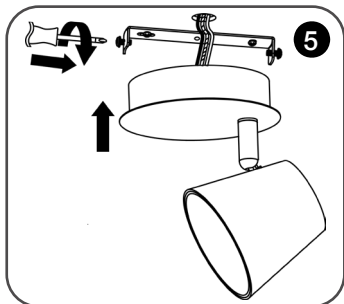
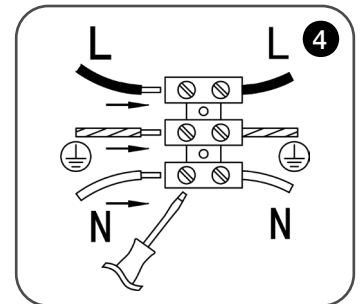
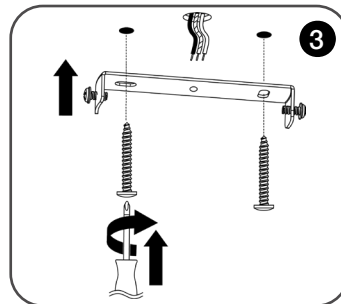
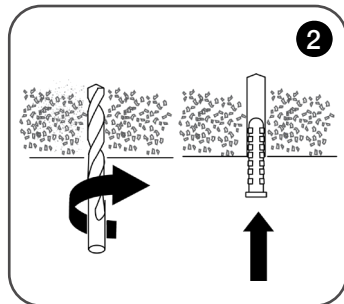
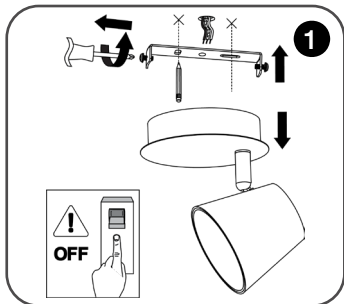

#### Safety Instructions

Read these instructions carefully before commencing installation.

1. The light source contained in this luminaire shall only be replaced by the manufacturer or this service agent or a similar qualified person.
2. This LED luminaire must be installed by a licensed electrician ONLY following all local regulations.
3. Ensure that the cables will not be squeezed or damaged by sharp edges.
4. Clean the light with a soft cloth and a standard PH-neutral detergent.
5. Misuse of/or changes to the appliance shall void all warranties.
6. Do not install on a surface that is not suitable or deformed.
7. Do not install on or above a surface with a high temperature.
8. There should not be any materials that are corrosive, explosive.



For detailed specification, please go to our website [eurotechlighting.co.nz](http://eurotechlighting.co.nz)