

TecMicro Oxygen Sensor



User Manual

Version 5

Gas Models	Liquid Models
TS-401 Trace 0-2,000ppm	TS-405 Trace 0-200 ppb
TS-402 Low 0-5,000ppm (5%)	TS-406 Low 0-2,000ppb (2mg/L)
TS-403 Medium 0-220,000 ppm (22%)	TS-407 Medium 0-10 mg/L
TS-404 High Range 0-100%	TS-408 High Range 0-40 mg/L



Contents

Introduction	1
Package Contents	1
Installing the Sensor	1
TecService Software	2
Settings Options	3
Start Log Button	3
Information Menu.....	3
Files Menu.....	4
Adjustment Menu (Calibration).....	5
Sensor Cap Menu – Sensor Cap Replacement.....	7
Maintenance	10
Cleaning.....	10
RS485 Commands	11
Command Structure and Syntax.....	11
Sensor Commands	11
Data String.....	11
Error Codes	12
Half-Duplex	12
Example Data Output.....	12
Specifications	13
Mechanical Specifications.....	13
Wiring Diagram	13
Models – Gas.....	14
Models - Liquid.....	15
Support.....	16

Introduction

TecMicro is an ATEX-rated optochemical sensor that determines the oxygen content in liquids and gases. It works according to the principle of fluorescence quenching. The decay time of the fluorescence event measured is proportional to the oxygen concentration in the sample.

The TecMicro sensor automatically calculates the oxygen concentration taking into account the media temperature and outputs this data as digital values. The data output is RS485 non Modbus. The sensor-specific calibration constants are stored inside the sensor.

An RS485 to USB cable is included to test and calibrate the sensor using the included software.

Package Contents

- TecSense TecMicro Sensor
- USB stick with the following files:
 - Declaration of Conformity including the calibration parameter
 - TecService.exe software for reading and displaying data via USB, testing and calibration
 - List of calibration parameters
 - Manual
- RS485 to USB Cable with power supply

Installing the Sensor

The sensor uses ½" fine thread to install from outside the gas or liquid container.

Before installing the sensor remove the black protective cap. Check that the elastomer seal is present on the flange at the union nut and fasten the sensor with a 24mm torque wrench to 10 Nm (7.38 ft-lbs) of torque. Do not overtighten.

Once the sensor is properly installed, it can be tested using the TecService software.

TecService Software

The TecMicro comes with a software utility on the USB key that allows you to graph the oxygen level over time, to save your data, to calibrate the sensor, to update the calibration when a new sensor cap is installed, and to provide feedback if service is required. Use of this program is important to the long-term accuracy of the TecMicro sensor. Therefore, it is recommended you run this once every 90 days to verify the remaining lifespan and accuracy of your sensor.

To install and run the TecService program:

1. On the USB key provided, find and open the TecServiceVXX.zip file.
2. Drag or copy the \TecService folder to your PC's hard drive. You must copy all the files in the \TecService folder.
3. Double-click to run the TecService Installer.msi program.
4. Click the "Port" dropdown to scan the list of available COM ports and find the TecMicro.
5. Click the "Measure" button to start a measurement.

Main Screen

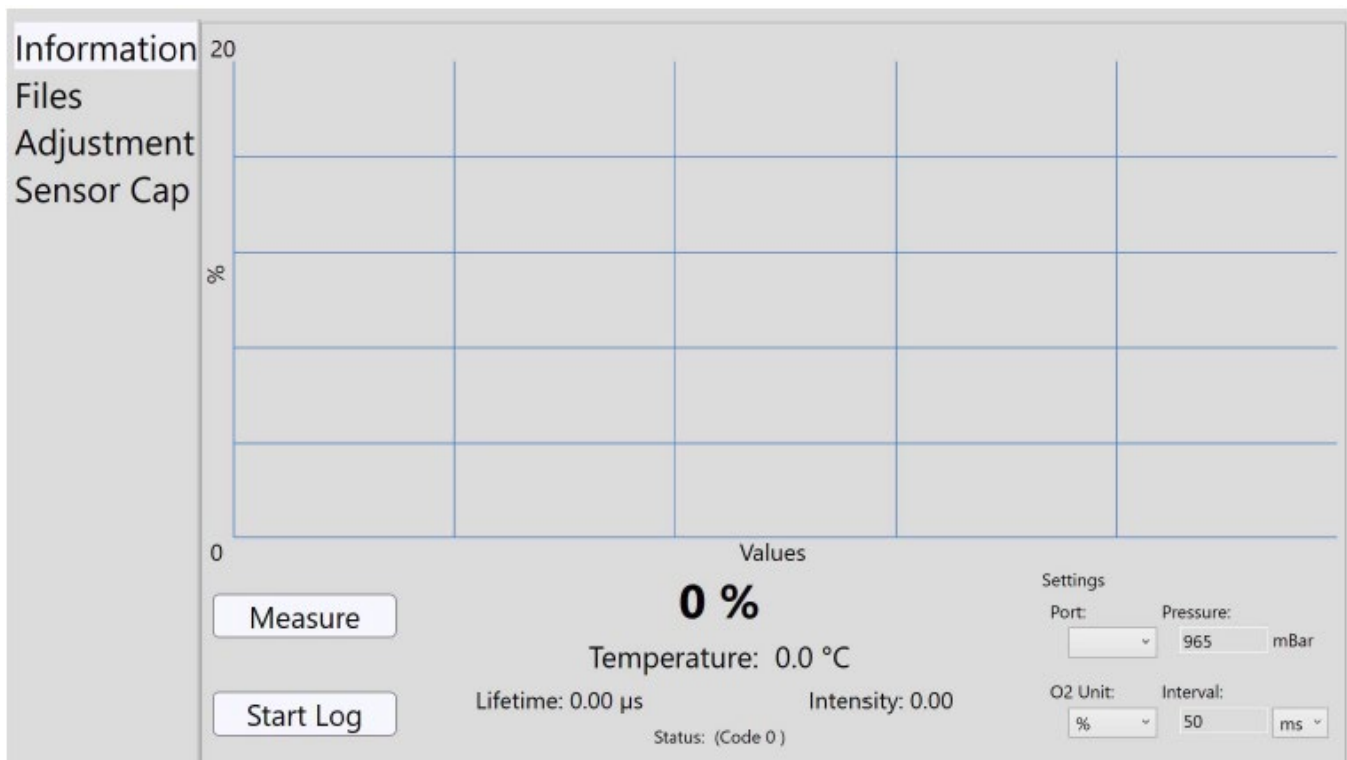

The center and the bottom of the screen displays the following:

- Measured oxygen concentration and on the graph over time
- Sample temperature
- Life time of the fluorescence quenching process
- Fluorescence intensity

The measurement function is always active.

Settings Options

- USB port used
- Pressure: Insert the gas pressure (not necessary for measurement in fluids)
- O2 Unit: Definition of the unit of O2 concentration
- Interval: Definition of the measurement interval

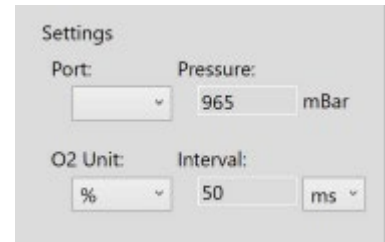

Start Log Button

To Start Data Logging

1. Select the appropriate settings on the right side
2. Enter the proper pressure if gases are measured
3. Click the “Measure” button on the left lower side
4. If the sensor is not connected the warning “No sensor detected” will display
5. Click the “Start Log” button to store the measured data

Stop Data Logging

1. Click the “Measure” button on the left lower side
2. To save the logged data or view old log files see the “Files” menu option below

Information Menu

This screen is used to verify the specific TecMicro sensor you are using and the current calibration set stored in the sensor’s memory.

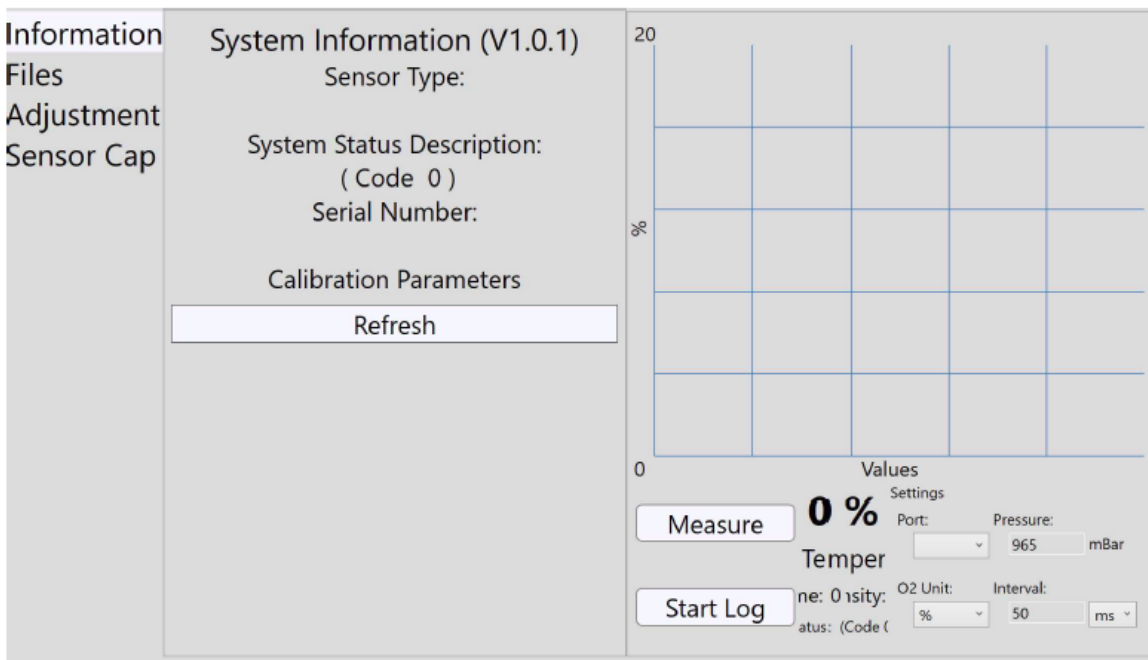

This information is important because it allows you to review the current sensor error codes including the lifetime left for the sensor cap.

- 00 System OK
- 01 No optical sensor detected
- 02 No Temperature sensor detected
- 04 Cap change recommended
- 08 Cap worn out – exchange sensor cap
- 16 Temperature out of range
- 32 Overload error
- 64 Settings configuration error

Files Menu

This menu shows the directories where the measurement data are stored and a list of the stored data created with the TecService program.

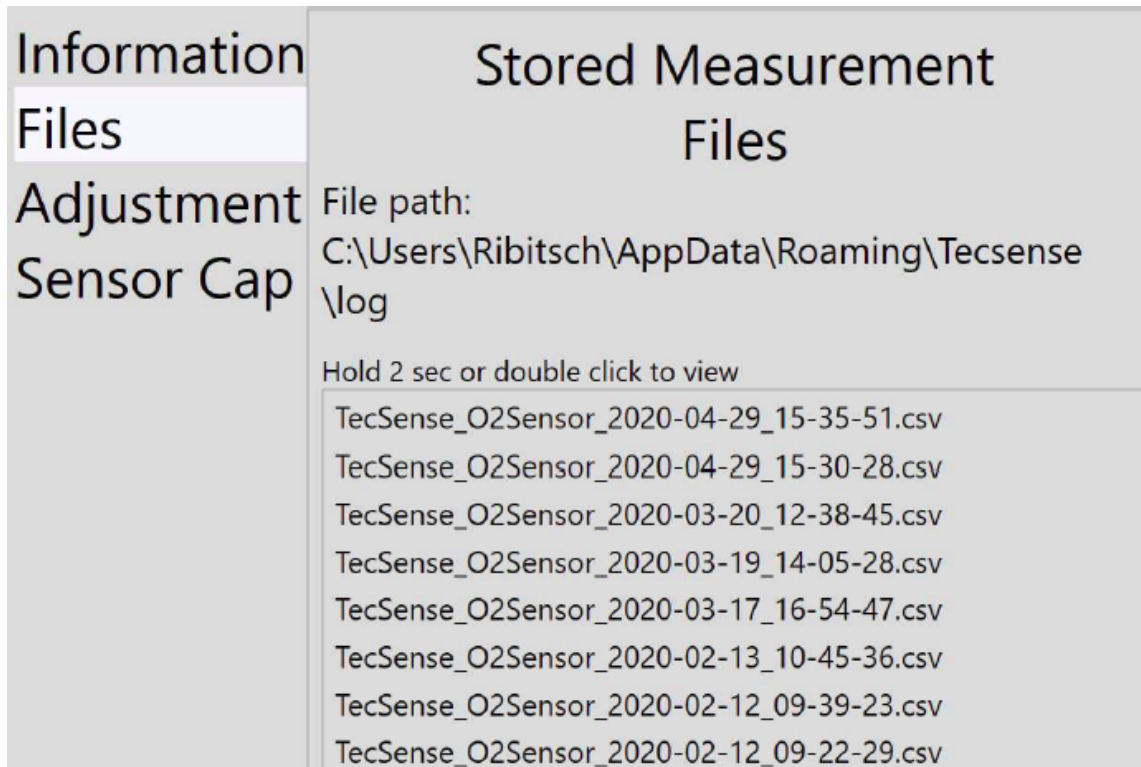

The data logs are stored in csv format with the following columns:

Date and time	Milliseconds since start	O2 value	Life time	Intensity	Pressure	Temperature
---------------	--------------------------	----------	-----------	-----------	----------	-------------

Adjustment Menu (Calibration)

This option allows you to single point recalibrate the sensor.

Single Point calibration should normally be carried out every 6 months using the TecService program and a test gas flowed past the sensor using a T-connector.

Preparation

The TecMicro is screwed into a ½ inch T connector as shown with pneumatic hose coupling at both ends. This part number TS-101 (in stainless steel) is available on our website.

One end of the hose is connected to a tank of test gas with a regulator set at a flow of 1L/minute.



The other end should be connected to a mechanical pressure regulator set to 100Mbar.



If no mechanical pressure regulator is available, a 100-200 ml glass bottle with a rubber cap with 3 outlets can be used as an "emergency" regulator. This ensures that the test is performed without pressure.



Before you begin calibration, flow the test gas across the sensor for at least 10 minutes to insure that it is fully immersed in test gas. The test gas must always be adapted to the measuring temperature and the sensor flushed with nitrogen without pressure.

Operating the adjustment button on the upper left side will offer the following calibration options:

- 0%
- Working
- End

The screenshot shows a software interface for sensor adjustment. On the left is a sidebar with menu items: Information, Files, Adjustment (highlighted), and Sensor Cap. The main panel is titled 'Adjustment' and contains the following elements:

- Text: 'Choose the O2 concentration to adjust with:'
- Radio buttons: 0 %, Working, End
- Text: 'Give the adjustment a name (optional):'
- Text input field for the name.
- 'Start' button.
- Table of adjustment records:

Name	Date
Original	20.01.2020
16:18	20.01.2020
16:19	20.01.2020

Single Point Adjustment with 100% Nitrogen

For single point or 0% adjustment, the T-fitting and tubing are purged for several minutes with N₂ (N₂ 5.0) as previously described. When you are confident the system has been purged, press “Start”. to display the current oxygen value and “Accept” to change the current oxygen level to your new zero point. The new calibration parameter is stored and used.

If the new calibration adjustment data set is not given a name, a default date/time stamp name will be used automatically.

Known Gas (Working) Adjustment

A test gas with a defined concentration, e.g. 2% can be used to adjust the sensor to a working point. This kind of adjustment may be used when a process is set to an oxygen concentration with a specific target, e.g. 2%.

WARNING: Working or End adjustments cannot be used outside the stated range of the sensor.

To use a “Working” gas adjustment, prepare for calibration by following the same steps as single-point adjustment, except use a target test gas that matches your working concentration.

End Point Adjustment

Like a Known-Gas Working Adjustment, an End Point Adjustment can be made if a known gas of the highest oxygen level the sensor will read is present.

To use an End Point gas adjustment, prepare for calibration by following the same steps as single-point adjustment, except use a target test gas that matches your working concentration. For medium range (gas) sensors, the known end point can be fresh air.

After Adjustment

Once you click "Accept adjustment" one of the following codes will be transmitted:

- 00 System OK
- 01 No optical sensor detected
- 02 No Temperature sensor detected
- 04 Cap change recommended
- 08 Cap worn out – exchange sensor cap
- 16 Temperature out of range
- 32 Overload error
- 64 Settings configuration error

Note the code carefully. For any codes except for 00-System OK you should first remedy the issue before attempting a calibration adjustment again. If you are unable to fix the problem, contact us with the code.

After the new calibration is accepted the adjustment parameters are calculated and stored in the sensor memory and a copy of is saved as a file with the date of their creation. This new set of calibration parameters can be recalled from the Adjustment menu. The factory calibration parameters are stored in the software under the name “Original” and can be retrieved at any time.

Sensor Cap Menu – Sensor Cap Replacement

Each sensor cap is uniquely calibrated at the factory. When a new sensor cap is installed, this option allows you to install the new cap’s calibration values into the TecMicro sensor.

While the sensor is designed to last for years, the sensor cap (the part that contacts the gas or liquid) is subject to chemical changes from contact with the measured gas or liquid which makes it necessary to change it regularly. The change interval depends on the

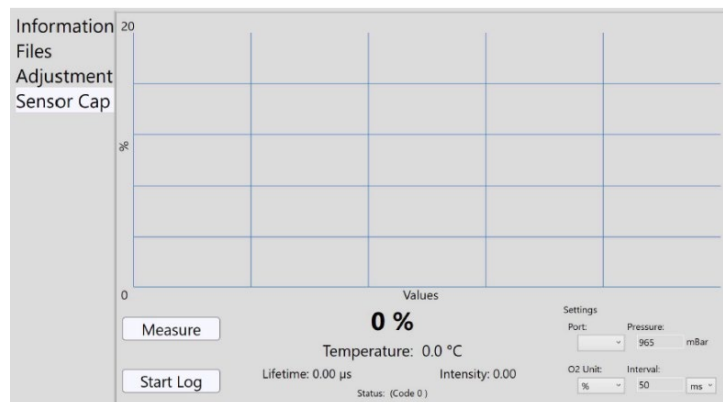

chemical load. For example, while the standard lifetime of the sensor cap is 6 months, it can last for up to 1 year for standard CIP processes.

The sensor gives a warning when approx. 80% of the sensor cap's service life has been reached, or signals when the sensor cap chemistry has worn out to such an extent that the measuring accuracy can no longer be maintained.

Tools and Instructions

To replace the sensor cap, follow the instructions below.

1. If the sensor cap is used in liquid, let it dry before proceeding.
2. Remove the sensor cap from the holder using 11 and 12mm wrenches as shown.

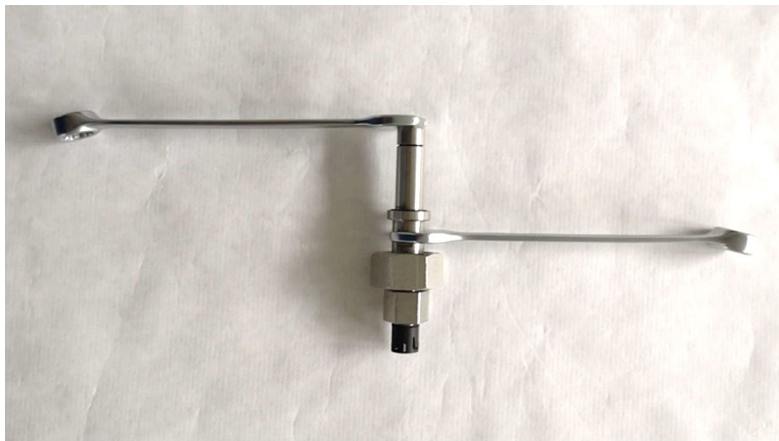

With the cap removed, the tip of the sensor optics is exposed. Touching or damage to the glass optics will destroy the sensor.



Replace the sensor cap and tighten with a precision torque wrench to 10 Nm (7.38 ft-lbs) of torque. Do not overtighten.

Updating the Cap's Factory Profile File

Each new sensor cap comes with a unique set of calibration profile parameters that must be loaded into the sensor's memory when the cap is replaced. To add the new profile:

1. Connect the sensor to a PC via a USB connection.
2. Plug in the USB stick (if supplied with the new sensor cap) or have the profile file emailed with the cap saved to your hard drive.
3. Start the TecService software. Insure you have a connection to the TecMicro sensor.
4. Select the Sensor-Cap option on the menu.
5. Click one of the 2 options: "Load the file received as email" or "Load from TecSense USB Stick" depending on how the .json calibration file was delivered. Click "Open" to use the file.
6. Wait for the file to be opened and installed into the TecMicro sensor's memory. The new file will overwrite the old sensor cap profile, and the sensor is ready to begin measurement again.

Status Check

After replacing the sensor cap and updating the cap profile, it is strongly recommended that you perform a calibration using the TecSense software program and pure nitrogen test gas. For more information, see the calibration procedure in the manual.

IMPORTANT

Each cap's calibration profile is exactly matched to a sensor cap at the factory. Using a different sensor cap's profile can drastically change the sensor's readings. If you inadvertently use the wrong sensor cap profile repeat the instructions above with the correct file.

Before installing the sensor at the measuring position remove the black protective cap. Check that the elastomer seal is present on the flange at the union nut and fasten the sensor with a 24mm torque wrench to 10 Nm (7.38 ft-lbs) of torque. Do not overtighten.

Maintenance

Apart from infrequent cleaning of the sensor cap (sometimes necessary when used with turbid liquids or gases with high dust content) or replacement of the sensor cap, no maintenance is required by the user. Replacing the sensor cap and entering the new calibration parameters is described above.

Cleaning

The sensors with specification "Clean in Place" (trace sensors for fluids) are equipped with a protective coating for standard CIP and SIP processes. All other need specific soft cleaning that the sensor chemistry is not damaged.

If cleaning is required, e.g. a deposited layer on the sensor membrane, cleaning with a water jet under low pressure or by swiveling in a mild cleaning solution or in 40% ethanol and subsequent rinsing with clear water is recommended.

Under no circumstances should the sensor surface be cleaned with a cloth or hard object.

Under no circumstances should the devices be exposed to direct sunlight or UV radiation, as this will dramatically reduce the life of the sensor.

RS485 Commands

The supplied connection cable is plugged into the TecMicro with a 4-pin round plug. Please ensure that the white markings on both parts of the connector match. This cable is used for power supply and data transfer.

Command Structure and Syntax

COMMAND SYNTAX: CMP/ R / N
 COMMAND <CR><LF>
 CMD R/N/

Each command has to be terminated by <CR><LF> to be recognized by the sensor. Unfinished commands can fill the buffer and lead to the sensor software crashing. Responses end with <CR><LF>.

Sensor Commands

Command	Explanation	Returns
?, C, c	Request list of commands	Table of commands
S	Start continuous measurement mode	53 character data strings
s	Stop continuous measurement mode	
R, r	Restart the system	
M, m	Start single measurement	53 character data string
O	Read calibration values	Table of calibration values
O X Y	Send new calibration value Y for X. Example: O tau_a0 045.485687	Table of calibration values with changed value

Data String

Name	Format	Example	Notes
O2 concentration	07.0f	0148568	Gas: ppm, fluid: ppb
Lifetime (tau)	010.6f	045.485687	
Amplitude	09.2f	013547.00	
Temperature	05.2f	21.56	Centigrade
Error code	02d	01	See table below

Error Codes

Code	Meaning	Notes
00	Sensor working correctly	
01	No optical sensor detected	
02	No temperature sensor detected	
04	Cap change recommended	80% service life detected
08	Cap worn out – exchange cap	
16	Temperature out of range	
32	Overload error	
64	Settings configuration error	

Half-Duplex

The RS 485 connection is half-duplex. This means that while the sensor is sending data, it cannot receive a command.

Example Data Output

Example of data stream, 53 characters with single spaces between values:

```
0148568 045.485687 013487.00 21.56 01\r\n
```

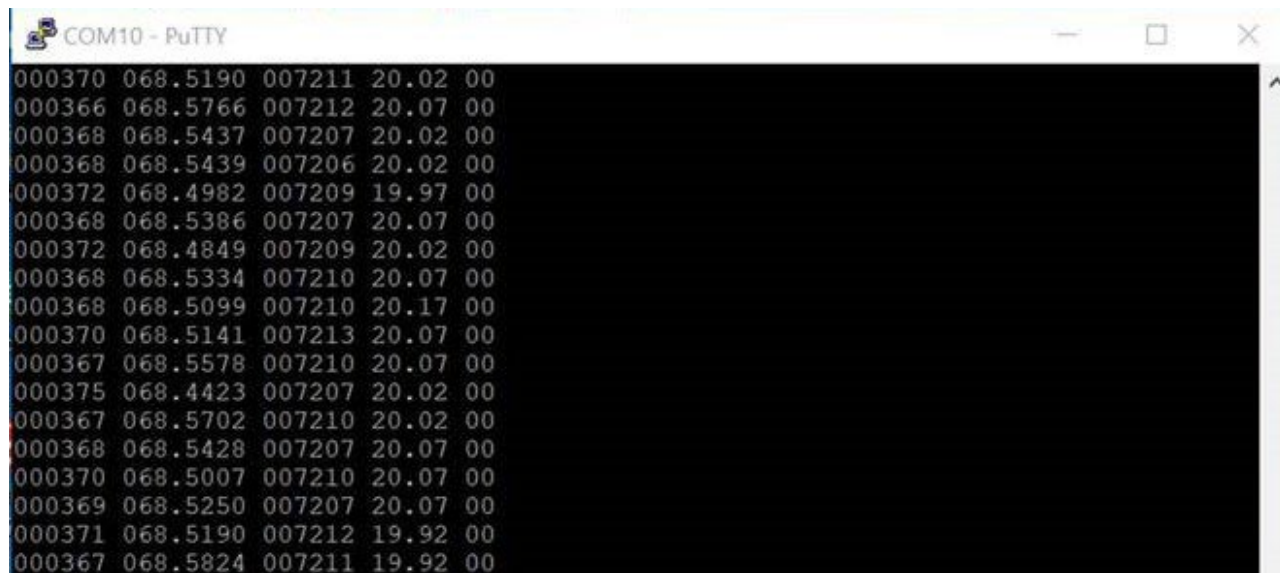

The screenshot shows a PuTTY terminal window titled 'COM10 - PuTTY'. The terminal displays a data stream consisting of 17 lines of text. Each line contains five values separated by single spaces: a 6-digit hexadecimal-like code, a 6-digit decimal value, a 6-digit hexadecimal-like code, a 4-digit decimal value, and a 2-digit hexadecimal-like code. The data stream is as follows:

```
000370 068.5190 007211 20.02 00
000366 068.5766 007212 20.07 00
000368 068.5437 007207 20.02 00
000368 068.5439 007206 20.02 00
000372 068.4982 007209 19.97 00
000368 068.5386 007207 20.07 00
000372 068.4849 007209 20.02 00
000368 068.5334 007210 20.07 00
000368 068.5099 007210 20.17 00
000370 068.5141 007213 20.07 00
000367 068.5578 007210 20.07 00
000375 068.4423 007207 20.02 00
000367 068.5702 007210 20.02 00
000368 068.5428 007207 20.07 00
000370 068.5007 007210 20.07 00
000369 068.5250 007207 20.07 00
000371 068.5190 007212 19.92 00
000367 068.5824 007211 19.92 00
```

Specifications

Mechanical Specifications

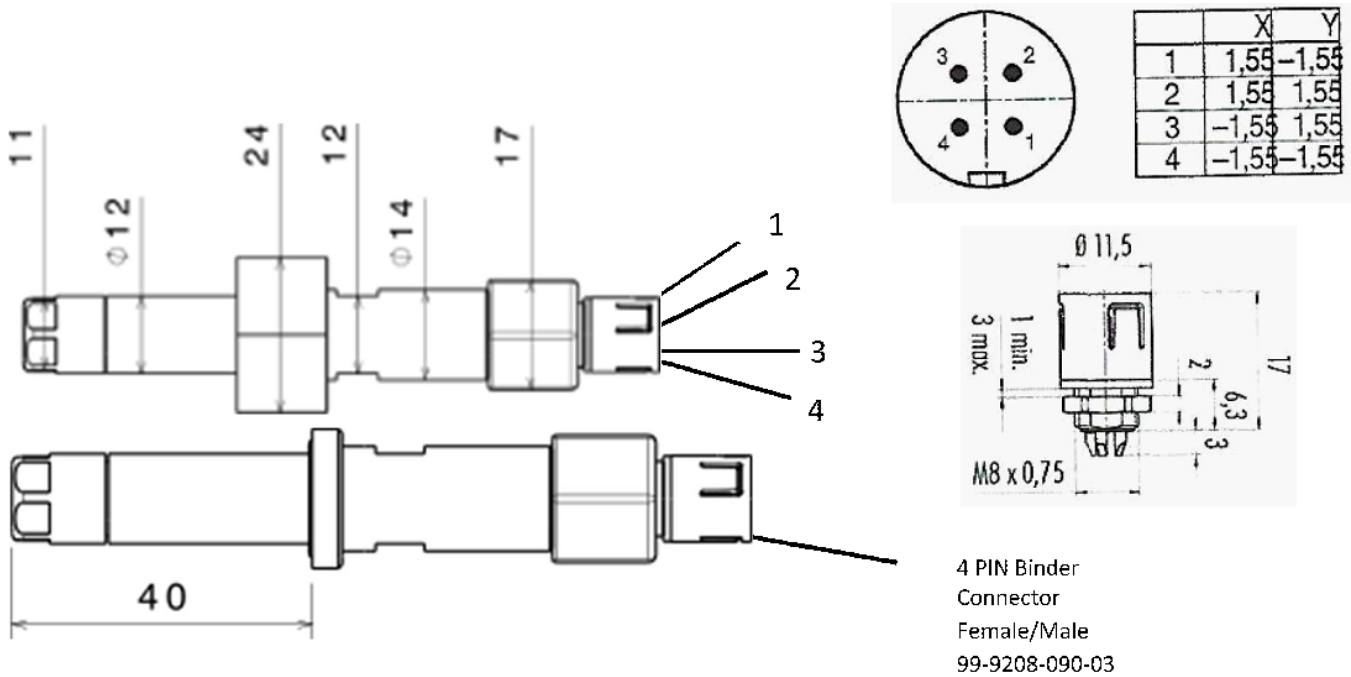

Dimensions: 12 x 60mm

Material: St. 1.4404 or Teflon

Case: St. 1.4404

Data exchange: RS485 non Modbus

Working temperature: 4°C - 60°C

Response time: 3 - 30 seconds depending on protective layer

Power supply: 5VDC, current consumption 100 mA

Trace sensors for fluids are equipped with a protective coating for standard Clean in Place and Sterilize in Place processes

Wiring Diagram

Wire	Signal	Pin
White	24VDC	3
Brown	Ground	4
Yellow	RS485+ (A)	2
Green	RS485- (B)	1
Connection: RS485 115.2K, 8/N/1 Non-Modbus, Half Duplex		

Models – Gas

TS-System Range	TS-401 Gas Trace 0-2000 ppm O2		TS-402 Gas Low Range 0-5% O2		TS-403 Gas Medium Range 0-22% O2		TS-404 Gas High Range 0-100% O2	
	Range	Accuracy	Range	Accuracy	Range	Accuracy	Range	Accuracy
	0-100ppm	± 2% Mev**	0-0.5%	± 2% Mev**	0-5%	± 2% Mev**	0-5%	± 3% Mev**
100-1000ppm	±3% Mv*	0.5-2.5%	±3% Mv*	5-15%	±3% Mv*	5-22%	±4% Mv*	
1000-2000ppm	± 4% Mv*	2.5-5%	±5% Mv*	15-22%	± 3% Mv*	22-100%	± 5% Mv*	
Resolution	1ppm		0.001%		0.001%		0.001%	
Response time at 25°C/ 77°F	< 15s		5 sec w/o protective layer		5 sec w/o protective layer		5 sec w/o protective layer	
Max. Pressure	5bar		5 bar		5 bar		5 bar	
Temp. range Min./Max	-10°C/ +60°C		-10°C / +60°C		-10°C / +60°C		-10°C / +60°C	
	14°F/140°F		14°F/140°F		14°F/140°F		14°F/140°F	
Medium	Gas		Gas		Gas		Gas	
Average lifetime LED	10,000 hours minimum		10,000 hours minimum		10,000 hours minimum		10,000 hours minimum	
Power supply	5VDC		5VDC		5VDC		5VDC	
Data Interface	USB / RS485		USB / RS485		USB / RS485		USB / RS485	
Temperature compensation	4 - 40°C		4 - 40°C		4 - 40°C		4 - 40°C	
	39 - 104°F		39 - 104°F		39 - 104°F		39 - 104°F	
Pressure compensation	STP by default. Changed in software		STP by default. Changed in software		STP by default. Changed in software		STP by default. Changed in software	
Data Output	Digital		Digital		Digital		Digital	
Cleaning	No organic solvents, 40% EtOH		No organic solvents, 40% EtOH		No organic solvents, 40% EtOH		No organic solvents, 40% EtOH	
Parts touching sample	St.1.4404/ PTFE/ Glass		St.1.4404/ PTFE/ Glass		St.1.4404/ PTFE/ Glass		St.1.4404/ PTFE/ Glass	
Connection	1/2" hex nut		1/2" hex nut		1/2" hex nut		1/2" hex nut	
Protection	IP65		IP65		IP65		IP65	
Guaranteed Sensor cap lifetime @ 5-60°C, no corrosive gases or hydrocarbons	1 year		1 year		1 year		1 year	
Sensor cap replacement interval	1 year. May be longer if verified in software		1 year. May be longer if verified in software		1 year. May be longer if verified in software		1 year. May be longer if verified in software	
Expected lifetime of cap under defined conditions	1 year		2 years		2 years		2 years	
Recommended zero point adjustment by customer	3 months		3 months		3 months		3 months	
Full service interval by manufacturer	3 years		3 years		3 years		3 years	

**Mev = measured end value

*Mv = measured value

Models - Liquid

TS-System Measurement range	TS-405 Fluid Trace 0 - 200 ppb		TS-406 Fluid Low Range 0 - 2000 ppb (2mg/L)		TS-407 Fluid Med. Range 0 - 10mg/L		TS-408 Fluid High Range 0 - 40mg/L	
	Range	Accuracy	Range	Accuracy	Range	Accuracy	Range	Accuracy
	0-200 ppb	± 2% Mv*	0-200ppb	± 2% Mev**	0-2 mg/L	± 2% Mev**	0-2 mg/L	± 2% Mev**
			200-1000 ppb	± 3% Mv*	2-8 mg/L	±3% Mv*	2-8 mg/L	±4% Mv*
			1000-2000 ppb	± 2% Mv*	8-10 mg/L	± 5% Mv*	8-10 mg/L	± 4% Mv*
							10-40 mg/L	± 5% Mv*
Resolution	1ppb		1ppb		0.001 mg/L		0.001 mg/L	
Response time at 25°C	<20s		<20s		<20s		<20s	
Max. Pressure	20 bar		20 bar		20 bar		20 bar	
Temp. range Min./Max	-10°C/ 60°C		-10°C/ 60°C		-10°C/ 60°C		-10°C/ 60°C	
	14°F/140°F		14°F/140°F		14°F/140°F		14°F/140°F	
Medium	Fluid		Fluid		Fluid		Fluid	
Average lifetime LED	10.000 hours min.		10.000 hours min.		10.000 hours min.		10.000 hours min.	
Power supply	5VDC		5VDC		5VDC		5VDC	
Data Interface	USB / RS485		USB / RS485		USB / RS485		USB / RS485	
Temperature compensation	4 - 40°C		4 - 40°C		4 - 40°C		4 - 40°C	
	39.2 - 104°F		39.2 - 104°F		39.2 - 104°F		39.2 - 104°F	
Data Output	RS485		RS485		RS485		RS485	
Cleaning	No organic solvents, 40% EtOH		No organic solvents, 40% EtOH		No organic solvents, 40% EtOH		No organic solvents, 40% EtOH	
Parts touching sample	St.1.4404/ PTFE/ Glass		St.1.4404/ PTFE/ Glass		St.1.4404/ PTFE/ Glass		St.1.4404/ PTFE/ Glass	
Connection	1/2" hex nut		1/2" hex nut		1/2" hex nut		1/2" hex nut	
Protection	IP65		IP65		IP65		IP65	
Guaranteed lifetime of sensor cap C5 (5-90°C or 41-194°F; CIP/SIP every 5th day)	6 months		6 months					
Guaranteed lifetime of sensor cap C3/C6/C10 in water w. protective layer (5 - 60°C or 41-140°F. pH 3-9)					12 months		12 months	
Sensor cap replacement interval	6 months. May be longer if verified in TecService software.		6 months. May be longer if verified in TecService software.		6 months. May be longer if verified in TecService software.		6 months. May be longer if verified in TecService software.	
Expected lifetime of cap under defined conditions	1 year		1 year		2 years		2 years	
Recommended zero-point adjustment interval by customer	3 months		3 months		3 months		3 months	
Full service interval by Manufacturer (includes necessary retrofitting)	3 years		3 years		3 years		3 years	

**Mev = measured end value

*Mv = measured value

Support

The quickest way to obtain technical support is via email. Please include a clear, concise definition of the problem and any relevant troubleshooting information or steps taken so far, so we can duplicate the problem and quickly respond to your inquiry.

Warranty

The TecPen comes with a (1) one year warranty starting from the date it was shipped to the buyer. For more information visit our website:

<https://www.GasLab.com/pages/terms-conditions>

Contact Us

We are here to help! For information or technical support, please contact us.

support@gaslab.com

(386) 872-7668

www.GasLab.com

GasLab, Inc.

131 Business Center Dr. Ste. 3

Ormond Beach, FL 32174 USA

