

Wireless Temperature & Humidity Sensor 900MHz LoRaWAN[®]

RN310 User Guide

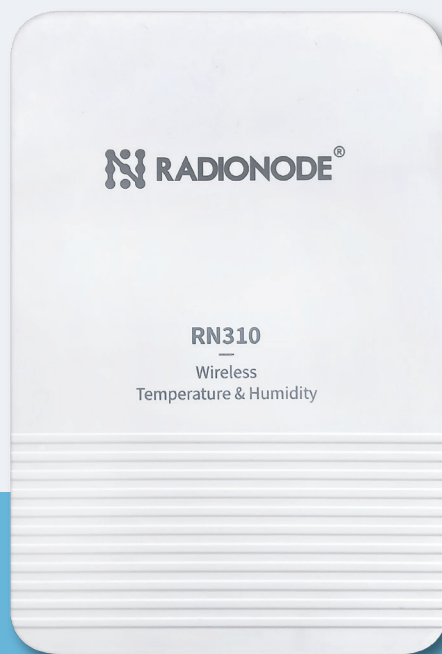

CONTENTS

About this Manual	03
Safety Precautions	03
Certifications	03
Intellectual Property Rights	04
Contact	04
Introduction	05
Key Features	06
Exterior	06
Product Components	07
Configuration	08
Turning on the RN310 and NFC communication Setup	08
Registering on Radionode 365 Cloud	10
Detailed Configuration Instructions	11
LoRaWAN Settings	11
Basic LoRaWAN Settings	11
LoRaWAN Frequency Settings	13
Basic Settings	14
Data Storage	15
Advanced Settings	16
Calibration Settings	16
Threshold Settings	16
Maintenance	17
Update	17
Backup	18
Reset to Factory Default	19
Installation	20
Screw Version	20
Magnetic Version	20
Data Format	21
Basic Information	21
Sensor Data	22
Downlink Commands	23
Historical Data Enquiry	24

About this Manual

This document contains instructions for usage and installation of the RADIONODE® RN310. Product specifications and certain features herein may be subject to change without prior notice. Figures used in this manual are for explanatory purposes only, and may differ from your system depending on installation conditions. Software screenshots may change after software updates.

Safety Precautions

DEKIST will not shoulder responsibility for any loss or damage resulting from not following the instructions of this operating guide.

The device must not be disassembled or remodeled in any way.

In order to protect the security of the device, please change device password when first configuration. The default password is 123456.

Do not place the device close to objects with naked flames.

Do not place the device where the temperature is below/above the operating range.

The device is not intended to be used as a reference sensor, and DEKIST will not should responsibility for any damage which may result from inaccurate readings.

The battery should be removed from the device if it is not to be used for an extended period. Otherwise, the battery might leak and damage the device. Never leave a discharged battery in the battery compartment.

Make sure all batteries are newest when install, or battery life will be reduced.

The device must never be subjected to shocks or impacts.

Certifications



이 기기는 사용 중 전파 혼신 가능성이 있으며, 타 기기로부터 유해한 혼신을 받을 수 있습니다.

Intellectual Property Rights

© 2011-2023(주)DEKIST. All rights reserved.

All information in this guide is protected by copyright law. Whereby, no organization or individual shall copy or reproduce the whole or part of this user guide by any means without written authorization from Xiamen DEKIST IoT Co., Ltd.

Contact

For assistance, please contact DEKIST technical support:

Email: master@dekist.com

Support portal: help.radionode365.com

Tel: +82-(0)70-7529-4359

Fax: +82-(0)31-8039-4400

Address: Tower-1801, 13, Heungdeok 1-ro, Giheung-gu, Yongin-si, Gyeonggi-do, Republic of Korea

Introduction

RN310 is a simple, compact and powerful LoRaWAN® temperature & humidity sensor. It is equipped with high-precision sensors and IP67 waterproof design, applicable for accurate temperature and humidity data detection in various harsh environments. FDA-approved food-grade material's enclosure allow it to be placed in freezers and refrigerators and in contact with food or medicines safely.

In addition to LoRaWAN® technology with low power consumption, it has built-in high-capacity batteries available for usage for up to 5 years without battery replacement. Moreover, RN310 is compatible with both DEKIST LoRaWAN® Gateway and DEKIST IoT Cloud to achieve remote data monitoring and management. It is suitable for both indoor and outdoor applications such as cold chain transportation, agricultural greenhouse, office buildings, hospitals, factories, etc.

Key Features

- Uses high-precision sensor, capable of sensor subtle changes in temperature and humidity
- IP67 waterproof enclosure with multi-level structure and sealing ring design enabling strong waterproof performance for harsh environments
- Uses FDA-approved food-grade material's enclosure, which is safe for contact with food or medicines
- Ultra-low power consumption and standby with 5400mAh built-in replaceable batteries, ensuring durable battery life
- Wall mounting or magnet version optional for multiple installation scenarios
- Anti-theft and anti-slip pad design on back cover to secure firm and sturdy installation
- Long range data transmission for up to 15 kilometers in rural areas
- Equipped with NFC for easy configuration
- Compliant with standard LoRaWAN® gateways and network servers
- Quick and easy management with DEKIST IoT Cloud solution

Exterior

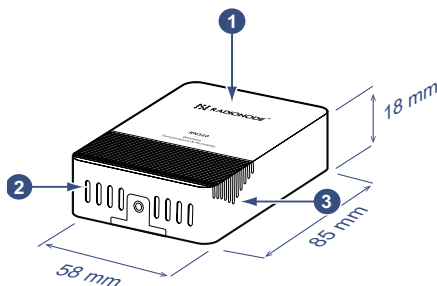

① NFC Area

② Vent

③ Vent

Product Components



1 × RN310
Sensor

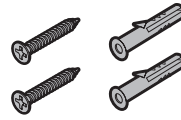

Wall Mounting Kits
(Screw version only)



1 × Fixing Screw
(Screw version only)



1x Mirror Holder



If any of the above items is missing or damaged, please contact your sales Representative.

Configuration

Turning on the RN310 and NFC communication Setup

RN310 sensor can be monitored and configured via NFC. Please refer the following steps to complete configuration.

1. Download and install "RNTools" App from Google Play or Apple App Store.

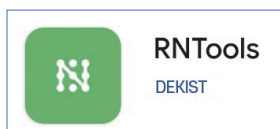

2. Enable NFC on the smartphone and launch RNTools.
3. While the RNTools app is in the 'Ready to Scan' state, place your smartphone in the NFC area to read device information. At this point, the 'Device Status' in the 'Status' menu will be OFF. Pressing this button will bring up the 'Ready to Scan' pop-up again. When you proceed with NFC touch again at this point, a message saying 'Booting' will appear, indicating that the power is turned on.

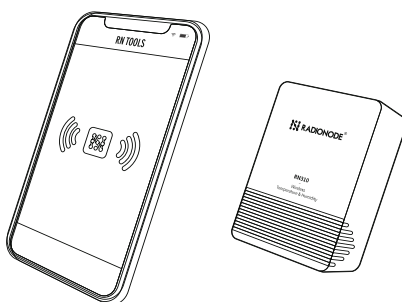

Note:

- 1) Ensure the location of smartphone NFC area and it's recommended to take off phone case.
- 2) If the smartphone fails to read/write configurations via NFC, keep the phone away and back to try again.
- 3) RN310 sensor can also be configured by dedicated NFC reader, which can be purchased from DEKIST IoT.

4. Once the device is successfully recognized, the RNTools app will display the device's basic information and settings. At this point, go to the "Status" menu, and slide the button under "Device Status" to activate it (ON).
5. You can configure the device by pressing the 'Read'/'Write' buttons in the app. For device security, please change the initially set password when configuring it for the first time. The default password is 123456.

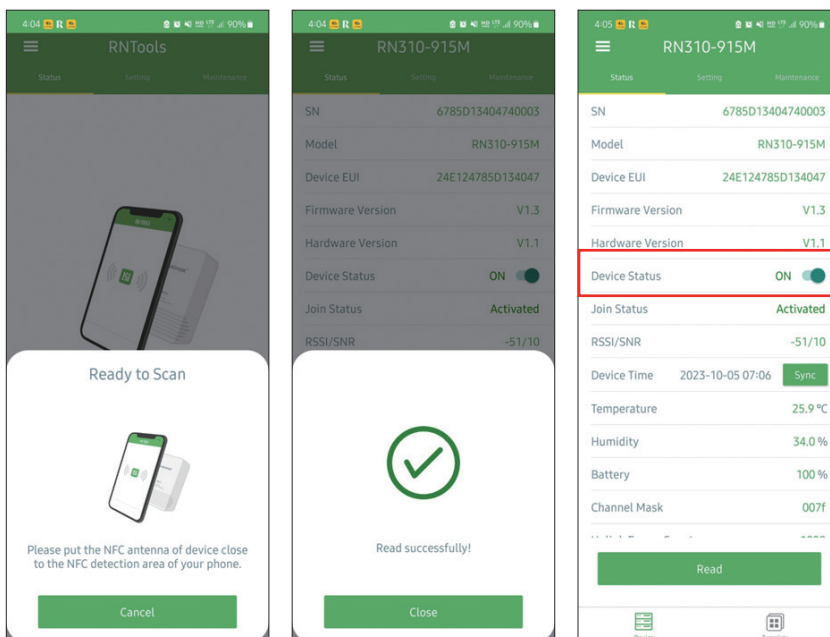

Registering on Radionode 365 Cloud

To register your RN310 product on Radionode365, you need to have a LoRa gateway already registered on Radionode365. Follow these steps to register your RN310:

1. Remove the rectangular panel(mirror holder) on the back of the RN310 to access the QR code and device information.



2. Scan the QR code on the back of the device, which will take you to the device registration web page. Log in with your Radionode365 account information.
3. Verify that the automatically retrieved DeviceEUI information matches the information on the back of the device. Then, click the "Search" button.
4. After confirming the device information, including model name, MAC, and IP, click the "Next" button.
5. Enter the device name that you want to manage on Radionode365. Select the channel to register, input the channel name and measurement unit, and click the "Next" button.
6. Your device and channel registration is complete. Additional settings can be configured at s2.radionode365.com. For related help and assistance, visit the support portal at help.radionode365.com.



Ensure that a Radionode365 registration sticker is attached to a gateway connected to the internet nearby, as this is required to register the device



Detailed Configuration Instructions

LoRaWAN settings is used for configuring the transmission parameters in LoRaWAN® network.

LoRaWAN Frequency Settings:

Go to “Setting → LoRaWAN Setting” of “RNTools “App to configure join type, App EUI, App Key and other information. You can also keep all settings by default.

The screenshot displays the 'LoRaWAN Settings' screen for the RN310-915M device. The settings are as follows:

- Device EUI:** 24E124785D134047
- * APP EUI:** 942fc06f6aa5c881
- * Application Port:** 85
- Join Type:** OTAA
- * Application Key:** *****
- LoRaWAN Version:** V1.0.3
- Work Mode:** Class A
- RX2 Data Rate:** DR0 (SF12, 125 kHz)
- RX2 Frequency:** 921900000
- * Support Frequency:** KR920

At the bottom, there is a 'Write' button and a '922.1' field with minus and plus buttons. The bottom navigation bar shows 'Device' and 'Template' icons.

Parameters	Description
Device EUI	Unique ID of the device which can also be found on the label.
App EUI	Default App EUI is 24E124C0002A0001.
Application Port	The port is used for sending and receiving data, default port is 85.
Join Type	OTAA and ABP mode are available.
Application Key	Appkey for OTAA mode, default is 5572404C696E6B4C6F52613230313823.
Device Address	DevAddr for ABP mode, default is the 5th to 12th digits of SN.
Network Session Key	Nwkskey for ABP mode, default is 5572404C696E6B4C6F52613230313823.
Application Session Key	Appskey for ABP mode, default is 5572404C696E6B4C6F52613230313823.
L o R a W A N Version	V1.0.2, V1.0.3, V1.1 are available.
Work Mode	It's fixed as Class A.
RX2 Data Rate	RX2 data rate to receive downlinks.
RX2 Frequency	RX2 frequency to receive downlinks. Unit: Hz
Spread Factor	If ADR is disabled, the device will send data via this spread factor.
Confirmed Mode	If the device does not receive ACK packet from network server, it will resend data once.
Rejoin Mode	Reporting interval \leq 30 mins: the device will send a specific number of LinkCheckReq MAC packets to the network server every 30 mins to validate connectivity; If there is no response, the device will re-join the network. Reporting interval $>$ 30 mins: the device will send a specific number of LinkCheckReq MAC packets to the network server every reporting interval to validate connectivity; If there is no response, the device will re-join the network.
Set the number of packets sent	When Rejoin Mode is enabled, you can configure the number of LinkCheckReq packets sent.
ADR Mode	Allow the network server to adjust the device's data rate.
Tx Power	Select the wireless output.

Note:

- 1) Select OTAA mode if you use Radionode365 to manage devices.
- 2) Only OTAA mode supports rejoin mode.

LoRaWAN Frequency Settings:

Go to "Setting → LoRaWAN Setting" of RNTools App to select supported frequency and select channels to send uplinks. Make sure the channels match the LoRaWAN® gateway.

Support Frequency
KR920
<input checked="" type="checkbox"/> - 922.1 +
<input checked="" type="checkbox"/> - 922.3 +
<input checked="" type="checkbox"/> - 922.5 +
<input type="checkbox"/> - 920 +
<input type="checkbox"/> - 920 +

If frequency is one of CN470/AU915/US915, you can enter the index of the channel that you want to enable in the input box, making them separated by commas.

Examples

- 1, 40: Enabling Channel 1 and Channel 40
- 1-40: Enabling Channel 1 to Channel 40
- 1-40, 60: Enabling Channel 1 to Channel 40 and Channel 60
- All: Enabling all channels
- Null: Indicates that all channels are disabled

Basic Settings

Go to "Setting → General Setting" of RNTools App to change the reporting interval, etc.

Parameters	Description
Reporting Interval	Reporting interval of transmitting current sensor values to network server. Default: 10 mins, <ul style="list-style-type: none">▪ Range: 1-1080 mins
Temperature Unit	Change the temperature unit displayed on the RNTools. Note: <ol style="list-style-type: none">1) The temperature unit in the reporting package is fixed as °C.2) Please modify the threshold settings if the unit is changed.
Data Storage	Disable or enable data storage locally. (see section 3.4.3 to export data)
Data Retransmission	Disable or enable data retransmission. (see section 3.4.4)
Change Password	Change the password for RNTools App or software to read/write this device.

Data Storage

RN310 sensor exports data via RNTools App. The device will record the data according to reporting interval even not joining network.

1. Go to **“Setting → General Setting”** of RNTools App to enable data storage feature.
2. Go to **“Maintenance”** of RNTools App, click **“Export”**, then select the data time range and click **“Confirm”** to export data. RNTools App can export last 7 days’ data at most.

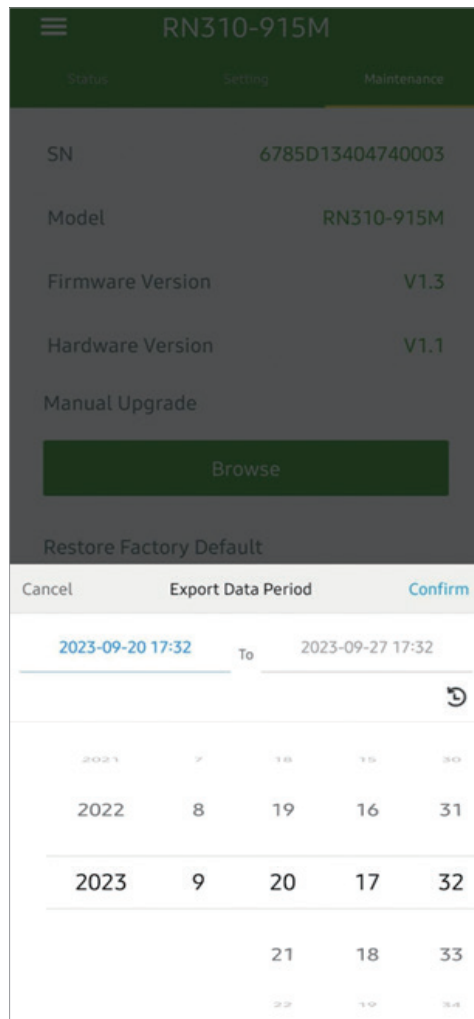

3. Click **“Data Cleaning”** to clear all stored data inside the device.



Advanced Settings

Calibration Settings

RNTools supports numerical calibration for all items. Go to “Device → Settings → Data Collection Settings” of RNTools App to type the calibration value and save, the device will add the calibration value to raw value.

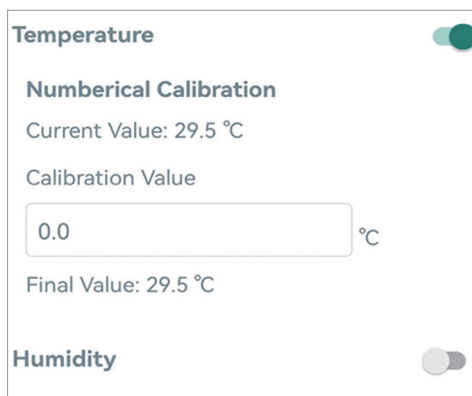

Temperature

Numerical Calibration

Current Value: 29.5 °C

Calibration Value

°C

Final Value: 29.5 °C

Humidity

Threshold Settings

Go to “Device → Settings → Threshold Settings” of RNTools App to enable the threshold settings and input the threshold, it will upload the current data once instantly when temperature is over or below the threshold. Note that when you change the temperature unit, please re-configure the threshold.

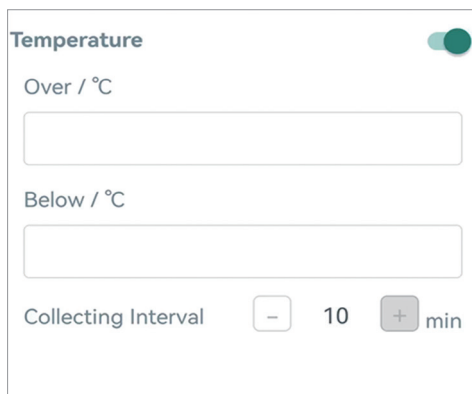

Temperature

Over / °C

Below / °C

Collecting Interval 10 min

Maintenance

Update

RNTools App:

1. Download firmware from www.radioode365.com to your smartphone.
2. Open RNTools App and click "Browse" to import firmware and upgrade the device.

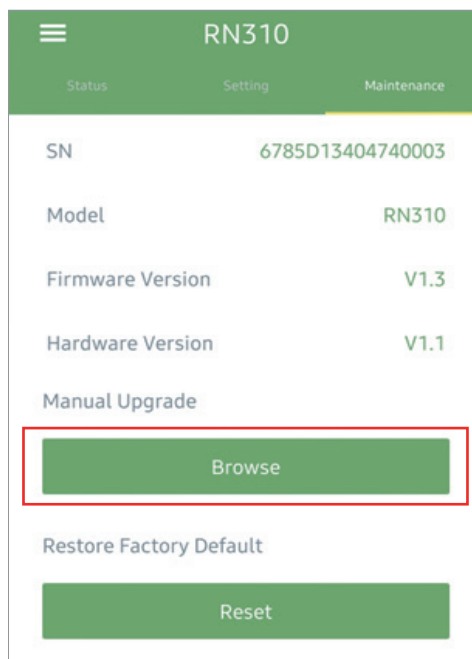

Note:

- 1) Operation on RNTools is not supported during the upgrade.
- 2) Only Android version RNTools supports the upgrade feature.

Backup

RN310 sensor supports configuration backup for easy and quick device configuration in bulk. Backup is allowed only for devices with the same model and LoRaWAN® frequency band.

RNTools App:

1. Go to "Template" page on the App and save current settings as a template. You can also edit the template file.
2. Select one template file that saved in the smartphone and click "Write", then attach it to another device to write configuration.

Note: Slide the template item to the left to edit or delete it. Click the template to edit the configurations.

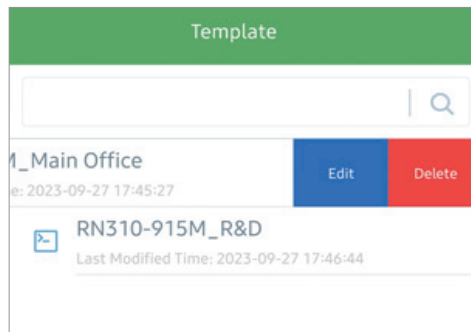

Reset to Factory Default

Please select one of following methods to reset device:

Please select one of following methods to reset device:

Via Hardware: Hold on reset button inside the device more than 10s.

Via RNTools App: Go to "Maintenance" to click "Reset", then attach smart phone with NFC area to device to complete reset.

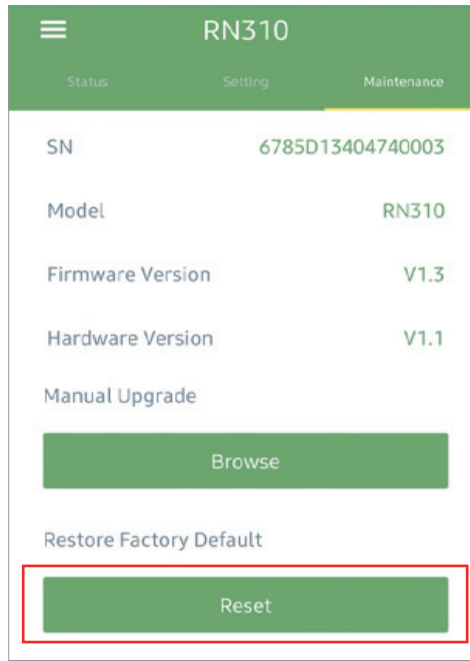

Installation

Screw Version

1. Remove the backplate on the back of the device, screw the wall plugs into the wall and fix the backplate with screws on it, then install back the device. Note that the vent of device should not face upwards when installing.

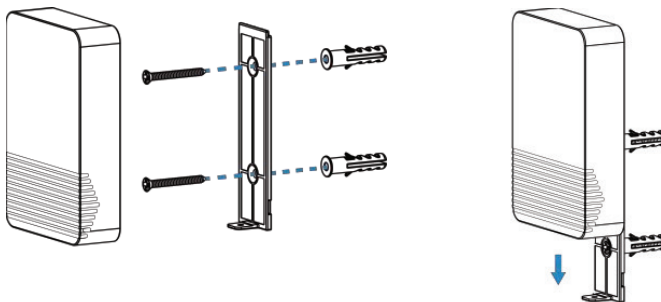

2. Fix the bottom of the device to the cover with a fixing screw.

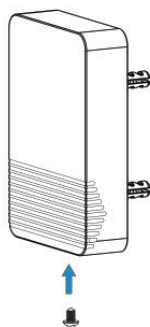

Magnetic Version

Attached the device to a magnetic surface such as the metal surface of the refrigerator, freezer, freight container, etc. The back of the device is equipped with anti-slip pad to secure firm and sturdy installation. Note that the vent should not face upwards.

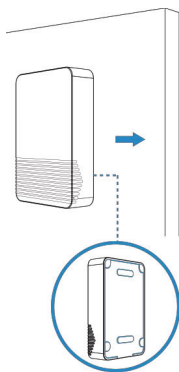

Data Format

All data are based on following format (HEX), the Data field should follow little-endian:

Channel1	1 Byte
Type1	1 Byte
Data1	N Bytes
Channel2	1 Byte
Type2	1 Byte
Data2	M Bytes
Channel 3	1 Byte
...	...

For decoder examples please find files on

<https://help.radionode365.com>

Basic Information

RN310 sensors report basic information of sensor whenever joining the network.

Channel	Type	Description
ff	01(Protocol Version)	01=>V1
	09 (Hardware Version)	01 40 => V1.4
	0a (Software Version)	01 14 => V1.14
	0b (Power On)	Device is on
	0f (Device Type)	00: Class A, 01: Class B, 02: Class C
	16 (Device SN)	16 digits

Example:

ff166785c38226020003 ff090110ff0a0101ff0f00

Channel	Type	Value	Channel	Type	Value
ff	16 (Device SN)	6785c38226020003	ff	09 (Hardware version)	0110 (V1.1)
ff	0a (Software version)	0101 (V1.1)	ff	0f (Device Type)	00 (Class A)

Sensor Data

RN310 sensors report sensor data according to reporting interval (10mins by default).

Item	Channel	Type	Description
Battery Level	01	75	UINT8, Unit: %
Temperature	03	67	INT16, Unit: °C, Resolution: 0.1 °C
Humidity	04	68	UINT8, Unit: %RH, Resolution: 0.5 %RH

Example:

017564 03672201 046850					
Channel	Type	Value	Channel	Type	Value
01	75 (Battery Level)	64=>100%	03	67 (Temperature)	22 01=>01 22=>290 Temp =290*0.1 =29°C
Channel	Type	Value			
04	68 (Humidity)	50=>80 Hum =100*0.5 =69%			

Downlink Commands

RN310 sensors support downlink commands to configure the device. The application port is 85 by default.

Channel	Type	Description
ff	02(Set Collecting Interval)	2 Bytes, unit: s
	03(Set Reporting Interval)	2 Bytes, unit: s
	06 (Set Threshold Alarm)	9 Bytes, CTRL(1B)+Min(2B)+Max(2B)+00000000(4B) CTRL: Bit0~Bit2: 000-disable 001-below (minimum threshold) 010-over (maximum threshold) 011-within 100-below or above Bit3~Bit7: 11001
	10 (Reboot)	ff (Reserved)

Example:

1. Set reporting interval as 20 minutes.

ff03b004

Channel	Type	Value
ff	03 (Set Reporting Interval)	b0 04=>04 b0=1200s =20 minutes

2. When temperature is below 20°C or over 30°C, it will upload current value immediately.

ff06ccc8002c0100000000

Channel	Type	Value
ff	06 (Set Threshold Alarm)	Ctrl: cc=>11001 100 100=> below or over Min: c8 00=>00 c8= 20 °C Max: 2c01 => 01 2c= 30 °C

3. Reboot the device.

ff10ff

Channel	Type	Value
ff	10 (Reboot)	ff (Reserved)

Historical Data Enquiry

RN310 sensors support sending downlink commands to enquire historical data for specified time point or time range. Before that, ensure the device time is correct and data storage feature was enabled to store the data.

Command format:

Channel	Type	Description
fd	6b (Enquire data in time point)	4 Bytes, unix timestamp
fd	6c (Enquire data in time range)	Start time (4 bytes) + End time (4 bytes), Unix timestamp
fd	6d (Stop query data report)	ff
ff	6a (Report Interval)	2 Bytes, unit: s, range: 30~1200s (60s by default)

Reply format:

Channel	Type	Description
fc	6b/6c	00: data enquiry success 01: time point or time range invalid 02: no data in this time or time range
20	ce (Historical Data)	Data time stamp (4 Bytes) + Data Contents (Mutable)

Note:

1. The device only uploads no more than 300 data records per range enquiry.
2. When enquiring the data in time point, it will upload the data which is closest to the search point within the reporting interval range. For example, if the device reporting interval is 10 minutes and users send command to search for 17:00's data, if the device find there is data stored in 17:00, it will upload this data; if not, it will search for data between 16:50 to 17:10 and upload the data which is closest to 17:00.

Example:

1. Enquire historical data between 2022/10/12 15:15:00 to 2022/10/12 16:35:00.

fd6c 74694663 347c4663

Channel	Type	Value
fd	6c (Enquire data in time range)	Start time: 74694663 => 63466974 = 1665558900 =2022/10/12 15:15:00 End time: 347c4663 => 63467c34 = 1665563700 =2022/10/12 16:35:00

Reply:

fc6c00

Channel	Type	Value
fc	6c (Enquire data in time range)	00: data enquiry success

20ce 9e744663 1001 5d

Channel	Type	Time Stamp	Value
20	ce (Historical Data)	56991a63 => 2022/10/12 16:03:53	Temperature: 1001=>0110=27.2°C Humidity: 5d=>93=56.5%

DEKIST
Embedded Web Service

© 2023 DEKIST Co., Ltd.

Telephone 1566-4359

Fax (+82) 31-8039-4400

Email master@dekist.com

#A1801, 13, Heungdeok 1-ro, Giheung-gu, Yongin-si, Gyeonggi-do, Korea 16954