

此页不印刷（本文件共24页）

SIZE:90mm X 120mm

材质: 封面铜版纸 内页: 书纸

工艺: 封面过亚膜

 PANTONE Black C

注意：不要随便删减空白页（特别是封面内页不能出现印刷内容）

TOGUARD®

CE80A

TOUCH SCREEN STREAMING
VIDEO REAR VIEW MIRROR

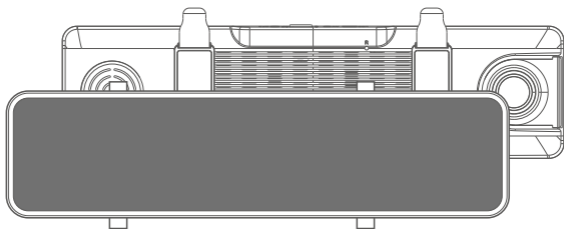

If you have any other questions or problems, Please feel free to contact us at

support@tguard.cc

We have professional team at your service, and your satisfaction is guaranteed.

V20201224

Important Notice:

- **NOTICE** : Due to the high power consumption of this unit, it should always be connected to an external power supply we provided inside package. This camera should not power on without external power supply connected.
- This product is intended for use in motor vehicle only. DO NOT install the device where it might block the driver's view of road (including the mirrors) or the deployment of the airbag.
- Before using this device, please insert the memory card first, and need to format micro SD card to FAT32 format on PC firstly, then format the memory card in camera menu.
- This device records video at high resolution, Be sure to use high speed memory card, U3 or above is recommended, 16GB or 32GB cards are recommended.
- We do recommend doing a benchmark test and make sure the unit is working perfectly before installing the unit on your vehicle.
- Be sure the lens is clean and there is nothing blocking the lens.
- Make sure you are using the original included power adapter to power the unit.
- DO NOT leave the device in direct sunlight for a long period of time or where the temperature could go above 170°F(75°C).
- The GPS function have to work with customized GPS module, please download "GX player". Please contact the seller for details.

Installation Guide

1. Before installation, please insert a high speed memory card in the unit and format the memory card in the unit setting, also do a simple test to make sure the unit is working perfectly.
2. Mount the mirror over the original rearview mirror and use the included rubber ring to fix it. Make sure the mirror is in the right place and secured.
3. Adjust the mirror angle according to your driving position, make sure the mirror is right in place and the view is clear.
4. Adjust the angle of the lens. Make sure you get best coverage over the hood and the road ahead, so you can record what happens.
5. Connect the power adapter to the mirror and the cigarette lighter, then route the power cable along the interior trim board, you can route it as indicated below, and hide the excess cable in the gaps for good looking.



6. The rearview camera should be installed at the rear end of the car, normally the best place is above the number plate. The camera can be fixed with the sticker or the screw. You can see the diagram for reference.

(NOTE: Please check whether the backup camera is installed upside down before you install screws.)

7. The excess RED lead near the rear view camera is used for reverse status sensing. Connect the RED cable to the positive lead of the reverse lamp power.

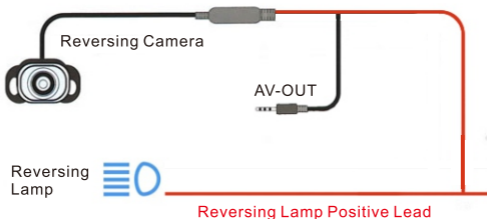

8. Route the backup camera cable to the front of the car and connect it to the main unit. There are 2 pictures for reference.

(NOTICE: Holes might need to be drilled to pass the cable and please check whether the cable for backup camera is long for your car before you install it.)



Wiring Method A



Wiring Method B

9. After the installation is completed, please start the engine and have a test run, make sure all functions are working.

NOTICE: The wiring and the installation requires certain hand work and some professional electrician skills, if you are not sure about it, please get some professional help.

Adjust the Reversing Camera

Adjust the reversing camera angle, the best angle is the the camera can cover the rear of the car and the ground surface under the rear end.

NOTICE:

When the car is in reverse, the rear camera will automatically display in full screen, and turn to the lowest angle, so you can see the ground surface under the rear end while reversing.

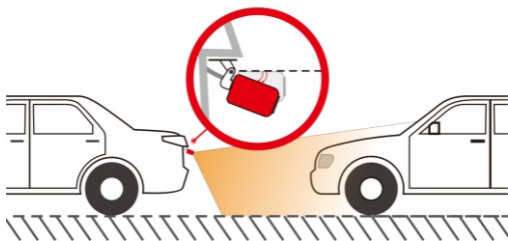

Interface and Button Functions

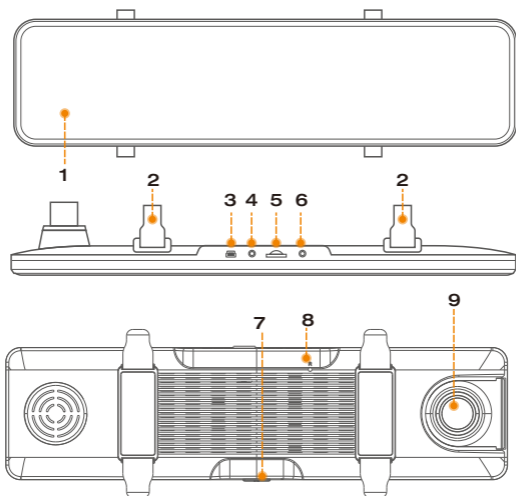

1.Touch screen

2.Securing clip

3.Mini USB

4.Real camera interface

5.Memory card slot

6.GPS interface(Optional)

7.Power

8.Reset

9.Lens

Power button

NOTICE :

Due to safety reasons and high performance of the CE80A mirror, the power consumption of the CE80A is relatively high, it should always be connected to external power supply to ensure working normally.

Power On/ Power Off

Long press the power button for 3 seconds to power off the unit.

Turn off / Turn on Screen Display

When the unit is on, short press the power button to turn off the screen display, enter the power saving mode(the recording is still working with screen off); Short press the power button or touch the screen to reactivate screen display again.





Reset button

If the recorder somehow crashes or malfunctions, press the [RESET] key to reset the unit and press the [POWER] button again to restart the device.

The main interface and Operations

When the mirror is powered properly, when you start the car engine, the unit will automatically power on and start recording. In the video recording interface, touch the screen to call up tool bar.



	Click to turn ON/OFF audio recording in video.
	Click to take a photo.
	Click to start/stop video recording.
	Click to enter Setup menu.
	Click to manually lock current video.

Shortcut Operation

In the recording interface, there are several shortcut operation:



1. In the recording interface, slide horizontally to the right to enter Playback Mode.

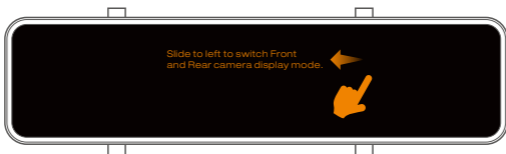

2. In the recording interface, slide horizontally to the left to switch Front and Rear camera display mode.

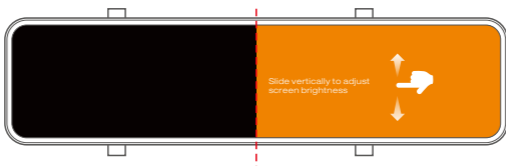

3. In the main recording interface and on the Right side of the screen, slide vertically up and down to adjust screen brightness.

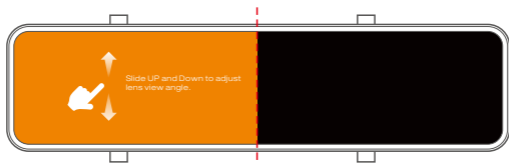

4. In the main recording interface and on the Left side of the screen, slide vertically up and down to move lens view angle.

Playback Mode



1. Return to the video interface.
2. Front video folder.
3. Rear video folder.

4. Front lock recording folder.
5. Rear lock recording folder.
6. Front photo folder.
7. Rear photo folder.

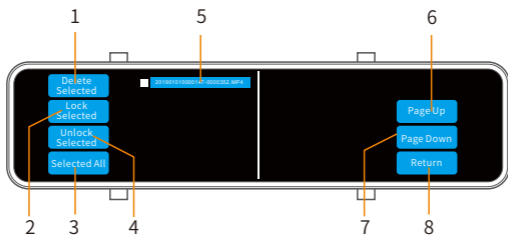

- 1.Delete selected files
- 2.Lock selected file
- 3.Select all
- 4.Unlock selected files
- 5.Video file, click to play
- 6.Turn page
- 7.Turn page
- 8.Return to the previous menu

Setup Menu

Setup	Option	How it works
Resolution	4K (F) + 1080P(R) 1080P (F) + 1080P(R)	Adjust video resolution, F for Front Camera, R for rear camera.
Loop Record	1 min / 3 mins / 5 mins	Adjust Loop Recording video clip length.
Record Audio	OFF / ON	Turn ON / OFF audio recording.
G-Sensor	OFF / Low / Middle / High	Adjust G-sensor lock sensitivity.
Parking Guard	OFF / Low / Middle / High	Adjust Parking Guard sensitivity.
License	Adjustable	Setup your car license plate number, and watermarked in video.
Screen Saver	OFF / 1 min / 3 mins/ 5 mins	Setup the screen saver activated time.
Video Encode	H.264/H.265	Ajust video encode. Under the front4K recording, the video encodingformat cannot be switched
Frequency	50Hz / 60Hz	Setup local power frequency.
Key Voice	ON / OFF	Turn ON / OFF operation prompt.
Speaker	OFF/ Low / Middle / High	Adjust the speaker volume.
Boot Sound	ON / OFF	Turn ON / OFF system boot up notification.
Stream Media	ON / OFF	Turn ON / OFF streaming media mode.
Language	English / Chinese / Japanese / Russian / German / French / Spanish / Italian	Setup the system menu language.

Setup	Option	How it works
Date/Time	Adjustable	Setup local date and time.
Default Setiing	Cancel / Confirm	Format the memory card and delete all data.
Default	Cancel / Confirm	Restore the mirror to factory default status.
Time Zone	Adjustable	Setup the time zone according to your location.
Voice Command	ON / OFF	Turn ON / OFF Speech Recognition.
Version		Check software version.
GPS test		Test GPS signal
Speed Calibration	Adjustable	Precision speed
Speed Unit	KM/H or MP/H	Speed unit adjustment

Featured Function

Dual Recording

The CE80A mirror comes with dual channel lens, they can record video in Front 4K (2880*2160) + Rear 1080P (1920*1080) simultaneously.

Loop Record

This function allows you to set video file length to 1/3/5 minutes, Select a value to activate loop recording, so when storage fills up, the CE80A will automatically loop back to the earliest file and record over it.

EG

If set the time 3 minutes, then the unit will keep recording video in 3 minutes clips, When the card is full, the unit will keep recording and overwrite the earliest unprotected 3minutes video file and so forth.

G-Sensor

The CE80A has a built-in Gravity sensor, In the event of a serious vehicle collision or rapid acceleration / deceleration, the G-sensor will be triggered and immediately lock current video file so the file will not be overwritten by loop recording.

Parking Guard

The Parking Monitor is used to protect your car after parking, with this function on, after you stop the car and the unit turns off, it stays in standby, when unit detects significant shock, it will automatically turn on and take a 20 seconds short video, then shut down automatically.

Video recorded under parking monitor will be protected and will not be overwritten by loop recording.

Screen Saver

Set the time after which the unit will automatically turn off screen.

Used to save power and reduce distraction while driving. For example, it is set to 3 minutes, if the unit is not operated in 3 minutes, the unit will automatically turn off screen while the recording is still working, any button operation or touch the screen will reactivate the screen display.

Voice Command

The CE80A features Speech Recognition function. You can use the specified Speech Recognition to complete certain operations. With Speech RecognitionFunction on, the CE80A mirror will act by command you said according to user manual.

The operation and Voice command are as follow:

Voice Command	Operation
screen on	The screen will light up.
screen off	The screen display will turn off.
lock video	Current video file will be locked.
open recorder	The audio recording will be muted.
close recorder	The audio recording will be restored.
front video on	The mirror will display front camera view in full screen.
real video on	The mirror will display rear camera view in full screen.
take photo	The Mirror will take a photo.
record video	Start recording.

NOTICE:

The Voice Command function is greatly affected by the accent. Try reading the commands loud and clear.

Streaming Media

The CE80A mirror features Streaming Media function, with this function on, the camera will display the rear camera view in full screen as default, It will work as a real rearview mirror.

GPS Function

With the optional GPS module connected, the CE80A can display current speed on screen. You can enter the setup menu and check the GPS signal status. The speed unit KM/H and MPH is optional.

NOTICE

The speed displayed is an average speed calculated based on the locations and time,there might be certain errors especially under low speed. It's for reference only.

GPS Logger

With the optional GPS module connected, the CE80A can record real-time GPS coordinate in the video file , it can be reviewed with the customized GPS player.

NOTICE

The GPS playback needs customized player "GXPlayer" (Please contact seller support to get it), for windows operating system only.

Specification:

Model	CE80A
Screen Display	12 inch (11.26 inch)
Screen Resolution	1920*440
Lens	Front and Rear Wide Angle Lens
Video Resolution	Front: 2880*2160/1920*1080P Rear: 1920*1080P
Video Format	MP4
Video Encode	H.264 / H.265
Image Format	JPG
Loop Recording	Built-in
Parking Monitor	Built-in
G-Sensor Lock	Built-in
Microphone	Built-in
Speaker	Built-in
Storage	Micro SD Card Up to 128GB (NOT included)
Operating Temperature	-20~60°C
Storage Temperature	-30~70°C
Operation Humidity	15~85%RH
Power Supply	DC 5V / 3A

Common Problem and Solution

Recorder shows memory full, unable to loop video, etc.

1. First, when a new memory card is used for the first time on the machine. Please format the memory card to FAT32 format on PC then format it in the camera.Or the memory card is previously used on another type of device,it needs to be formatted when used on this camera.Or change another new SANDISK 32G Micro SD CARD.
- 2.Check the sensitivity of G-sensor, If the sensitivity is too high,the bumping and shaking of the camera will trigger the G-sensor,and the file will be locked. Locked files cannot be overwritten.If the lock file is accumulated, there will be no memory card to loop record. When parking monitoring is turned on, shaking will also cause too many stray files, which will also affect the reading and writing of cards.

The device will automatically turn on or turn off.

- 1.Please format the memory card to FAT32 format on PC then format it in the camera.
2. Please check whether the parking guard function is on.With parking monitor on, the device will automatically turn on and record when it detects a collision or shaking.
3. Check the car charger connection status, if the connection is loose, the power supply is not stable, the camera will automatically turn on and off.

The rear camera does not display image

1. Please switch the camera display mode to double check the rear camera status.
2. Please check if the AV plug is properly connected and the cable is plugged in correctly.
3. Try to disconnect the camera and clean the connector with some Medical alcohol connect it again.

Screen operation or button reaction is slow during recording

1. Please check whether the memory card used is a high-speed card (U3), If you use a non-high-speed card, problems such as missed seconds, video playback jams, screen display Colorful stripes, and crashes may occur.
2. Reset the camera if necessary.

Even though set the screen saver, but the screen will randomly come back on.

The power supply might not be stable, please change another car charger to try.

