



**VAMOOSE**  
electric cycle ltd.

**MODEL:**  
**FS ODIN**

**EN**  
2021.V02

**VAMOOSE**

**KENDA**



# ***Congratulations!***

**Thank you for purchasing from Vamoose Electric Cycle Ltd. (Vamoose), and congratulations on being part of the electric cycle movement!**

Vamoose was founded to inspire people to enjoy the outdoors all year round with family, friends, and community. Vamoose strives to excite our customers and exceed their expectations, providing a range of well designed and well priced electric cycles that only use quality brand components.

This Owner's Manual provides an overview of the cycle and some of the key maintenance and operational requirements. Please read this Owner's Manual in its entirety before taking your new cycle for a ride.

**We're glad you're here.**

<http://www.vamoosecycle.com>

Tag us! Facebook: @VamooseCycle

Instagram: vamoose\_cycle

*Contact us at:*

Email: [hello@vamoosecycle.com](mailto:hello@vamoosecycle.com)

Phone: +1.587.991.2133

# Table of Contents

Mission	5
General Information	6
Safety Considerations	7-8
Legal Requirements & Intended Use	9
In the Box	10
Assembly	11
Assembly Instructions	112-15
Torques	16
Controls	17-18
Safety & Operation	19-25
The First Ride	26
Hydraulic Disk Brakes	27
Brake Bedding In	28
Troubleshooting	29-30
Pre-ride Safety	31-32
Limited Warranty	32
Frequently Asked Questions	34-35
Notes	36-37

## NOTICE:

This Owner's Manual contains information about the Vamoose electric cycle. Keep this Owner's Manual with the Vamoose cycle and refer to it for information whenever necessary.

The information contained in this publication is based on the latest information available at the time of publishing. Please note that all instructions and notices are subject to change and update without notice.



## ***MISSION***

**The Vamoose mission is to deliver  
power-assist cycles that will  
rejuvenate and recharge YOU!**

# General Information

## About this Owner's Manual

It is important for you to understand and get familiarized with your new cycle before your first ride. By reading this Owner's Manual prior to riding, you will improve your enjoyment, performance, and comfort from your new cycle.

Please note the following symbols:



### **WARNING**

Warnings, precautions, and potential risks associated with the use of your Vamoose electric cycle.



### **DANGER**

Possible dangers to your life and health if respective calls to action and instructions are ignored.



### **USEFUL NOTE**

Recommendation! Meaningful additional information.



For replacement parts, technical information and warranty assistance, please contact Vamoose Electric Cycle Ltd. directly.



Electric cycles may be dangerous. The operator and owner, jointly and severally, agree to assume all risks, dangers and hazards arising as a result of the cycle completely, of whatever nature, including but not limited to all risk of injury, death, property damage, and damage or loss resulting therefrom to you and others. The operator and owner, jointly and severally, agree to indemnify and save Vamoose Electric Cycle Ltd. and its directors, officers, shareholders, employees, agents and their respective heirs, successors and assigns harmless against any and all claims and liabilities that may arise from the cycle, of whatever nature.



**Negligence or non-compliance with the instructions herein contained in this Owner's Manual renders any warranties of Vamoose null and void. Proper maintenance of your cycle is your responsibility.**



Vamoose shall have no right of control over the cycle after the point of sale. Proper maintenance of your cycle is your responsibility. Vamoose shall have no right of control over the manner in which such work is done and shall, therefore, not assume any responsibility or risk respecting the same. As with all mechanical components, the cycle is subject to wear, stress, and fatigue. Materials and components react to wear, stress, and fatigue in different ways. If the designed life of a component has been exceeded, it may suddenly fail, possibly causing injury or damage.



Indications that the designed life of a component has been exceeded include, but are not limited to, cracks, scratches, and changes in color. Components that have exceeded their designed life should be replaced immediately prior to further use of the cycle.



**DO NOT DISASSEMBLE, MODIFY OR REPLACE ELECTRICAL PARTS OR COMPONENTS.**



Assembly of Vamoose cycles should be done by a professional cycle mechanic. If unsure or uncertain about the proper assembly or configuration of this product, please contact Vamoose Electric Cycle Ltd. directly or a local authorized retailer for support.



Vamoose cycles need regular maintenance and care to operate properly. You should not, at any time, perform work on a Vamoose cycle that is beyond the instructions in this Owner's Manual. Maintenance required that is beyond this Owner's Manual should be done by an E-Cycle specialist or professional cycle mechanic.



**THIS OWNER'S MANUAL IS NOT INTENDED AS A DETAILED SERVICE, REPAIR OR MAINTENANCE MANUAL. PLEASE SEEK ASSISTANCE FROM A QUALIFIED TECHNICIAN FOR SERVICE, REPAIRS OR MAINTENANCE.**



Do **NOT** ride your Vamoose cycle if it has been assembled incorrectly. Riding an incorrectly assembled cycle can put your own safety as well as the safety of others at risk.



**Perform a safety check as described on pages 31-32 of this Owner's Manual before each ride.**



## ***Legal Requirements***



The operator of the cycle must consult the laws and norms of the applicable jurisdiction to determine the requirements and restrictions on the use of the cycle. There may be restrictions, which may include, but may not be limited to, on age of operator, speed, motor wattage, helmet requirement and road accessibility. As it is the operator's responsibility to inform themselves of, and comply with, local laws and norms, Vamoose assumes no risk or liability in the event of non-compliance with the laws and norms of any jurisdiction.



Insurance providers, or specific insurance policies, may not provide coverage for accidents involving the use of this cycle, and the damage that may result therefrom. To determine your coverage, please contact your insurance company or agent.

## ***Intended Use***



**The cycle is intended to be used recreationally, when conditions permit.**

- The cycle is not intended to be used for stunts, jumps, acrobatics, aggressive riding, or similar or like activities.
- The cycle is not intended for use in competitions of any kind.
- The cycle is not intended for commercial use.
- The permitted maximum load of the cycle can not be exceeded at any time.
- Operation parameters, maintenance, guidelines, and service instructions described in this Owner's Manual are part of the intended use.



**Use of the cycle beyond its intended use, as herein described, may result in injury, death, property damage, and damage or loss resulting therefrom to the operator and others.**



**After receiving your new cycle, please check the exterior of the package. If you find any severe damage to the packaging please contact Vamoose by email at [hello@vamoosecycle.com](mailto:hello@vamoosecycle.com).**



The individual assembling the cycle should read the assembly instructions in their entirety before assembling the cycle. Failure to properly assemble the cycle may result in injury, death, property damage, and damage or loss resulting therefrom to the operator and others.

NOTE: This provision appears to condone a DIY assembly, where it was previously recommended that assembly be done by a qualified mechanic.



Open the carton box, remove all zip ties and packing material, and take out your Vamoose cycle carefully. The package should contain the following items:

- Pedals
- Rear light
- Battery Charger
- Vamoose ODIN Cycle
- Lithium Ion Battery
- Keys



Turn off the power and remove the battery from the cycle prior to performing any work on the cycle.

As well, make sure the power is off and the battery is removed during transport of the cycle by vehicle.

Accidental or involuntary activation of the electrical system carries risk of injury, death, property damage, and damage or loss resulting therefrom..



Perform a safety check as described on pages 31-32 of this Owner's Manual before each ride.



Figure 1: Components

# Assembly Instructions

## Installing the Handlebars

The handlebar has two main parts--the bar and the stem. The ODIN handlebar has been removed for shipping, and must be attached in order to ride. Position the bar in the center of the stem and ensure the correct position by aligning the cross hairs printed on the bar (see the pictures in Figure 1 below). Also, the cross hairs will ensure that your grips are properly aligned and in the correct position and the angle of the bar is comfortable.

- Loosen the bolts to put handlebar in place
- Use the reserved 4 bolts to install handlebar as shown in Figure 1 below
- Adjust handlebar angle and fasten the 4 bolts one by one to 6 N.m. (see page 15 for general torque information)
- Check that the forks and the handlebar are facing forward and straight by standing at the front of the handlebar. Grip the front wheel between your legs, hold the handlebar and adjust the handlebar and the body of the cycle to form a 90 degree angle.



Fig. 1: Handlebar installation

## Install Headlight

- The ODIN headlight will come installed, however, removal and reinstallation can be done easily.
- You can adjust the height and angle by loosening the bolt and nut, making the adjustment and then fastening the bolt back.
- Connect the light power cable by connecting the cables identified with green colour ends.

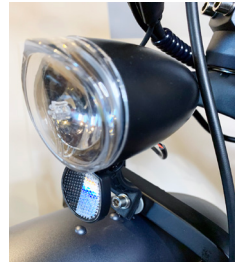
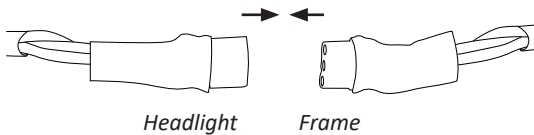

Fig. 2: Headlight



## Install Front Wheel

- Most deliveries of the ODIN electric cycles will arrive with the front wheel mounted.
- In the rare case that it does not come attached, put the front wheel in the middle of the front fork.
- Make sure the brake disc is placed in the center of the caliper gap and the front wheel can rotate freely without any noise. When the brake disc is not in the gap, DO NOT pull the brake lever.
- Install the front wheel and tighten the nuts provided. If your cycle has a quick release, adjust and close tightly.
- The fasten torque of the front wheel should be no less than 35-40 N.m. (no less than 35-40 N.m. for the rear wheel as well).

## Check and Adjust Brakes



- Ensure that the front brake is operated by the right brake handle and the rear brake is operated by the left brake handle.
- Cycle rotors are extremely sharp and may cause harm. If further adjustment is required, please contact a local authorized cycle mechanic to properly adjust the braking mechanisms.

## Install Pedals

- Use the pedal marked with an “L” on the left side and the pedal marked with an “R” on the right side (the side with drive-train gears).
- The right-side pedal has a right-hand thread (removes counterclockwise, installs clockwise); the left side pedal has a left-hand thread (removes clockwise, installs counterclockwise). Be careful not to cross thread the pedals.

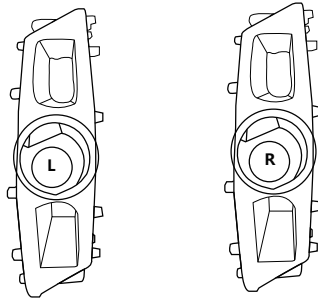

*Fig. 4: Pedals*

## Install the Seat Post

- Insert, remove or adjust the Saddle height

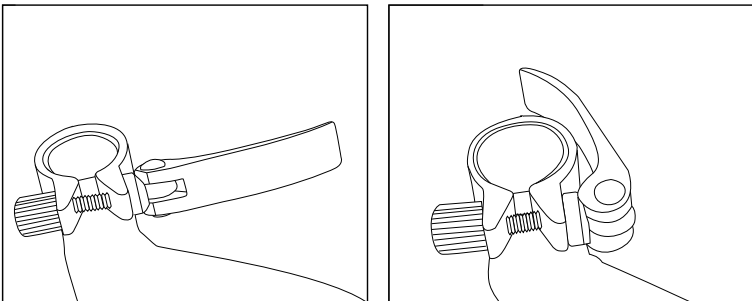

*Fig. 5: Seat Post*

## Charging the Battery

- Make sure to charge the battery before your first ride. Vamoose recommends charging the battery 6-8 hours for the first charge. This helps the lithium ion battery top up for optimum performance.
- On the charger adapter, the red light shows the battery is charging, while the green light indicates charging is complete.



*Fig. 6: Charging the Battery*



*Fig. 7: Battery Warnings*

# Torques

The Vamoose cycle is a piece of precise machinery. For your enjoyment and safety, it is important to ensure the correct torques on individual pieces of equipment. The recommended torque values are as follows:

## RECOMMENDED TORQUES

Torque required (N.m.)

Seat Post .....	16
Saddle .....	16
Handle Bars .....	6
Stem .....	7.5
Brake Levers .....	6
Brake Pinch Bolts .....	7
Shifter .....	6
Shift Cable Pinch Bolts .....	6
Crank Arms .....	42
Chainring Bolts .....	5
Pedals .....	50
Axle Hubs .....	50
Torque Brake Rotos (Front & Rear).....	6
Tighten Derailer .....	9



## Controls

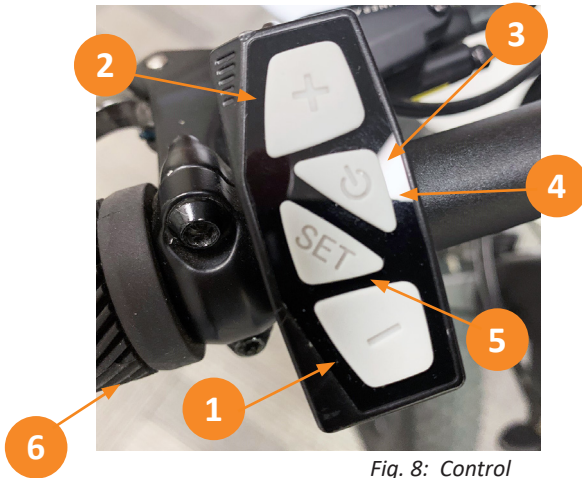

Fig. 8: Control

- 1 ..... PAS Down "-" also by pressing and holding the "-" button the ODIN will engage walking mode at approximately 6 km/h
- 2 ..... PAS Up "+"
- 3 ..... Headlight On/Off (double press)
- 4 ..... Power On/Off (hold)
- 5 ..... Settings Interface

### POWER ON/OFF

- To turn the electrical system on, press and hold the power button as indicated above in Figure 8: Control, Item 4.

### LIGHTS

- On the controls, there is a dual button for the power (hold) and to turn the headlights on or off. Double press the power button to activate.
- Don't forget to switch off the light when you finish riding. This operation helps extend the battery life.

## PEDAL ASSIST SYSTEM (PAS)

- On the left-hand control unit, the PAS system can be engaged, and can be set at 1-5 depending on the desired level of power articulation (can be changed in the Settings Interface).

## REAR MOTOR

- The Vamoose ODIN comes equipped with rear motor propulsion. However, you can choose to ride with or without motor assist power.
- Using the PAS (Pedal Assist) button identified in figure 8, the unit can cycle between 5 levels of pedal assist, with 5 providing the most support.

## BRIEF DISPLAY REVIEW

- To switch on the Vamoose cycle, press the power button on the handlebar. Press the power button again to turn off.
- After switching on the system, you can press the "+" or "-" button to switch between the PAS modes
- Press "+" or "-" to adjust the PAS speed level. There are 5 PAS levels.
- Press the information button for to enter the key settings interface.



Fig. 10: Display

# Safety & Operation

In addition to informing themselves of, and complying with, the laws and norms of the applicable jurisdiction, the operator must also comply with all safe operating practices. The safe operating practices include, but are not limited to:



## HELMET

Always wear an approved helmet, securely and correctly fastened, while riding your Vamoose Electric Cycle, and follow the helmet manufacturer's guidelines for fit, use and care.

## KEYS

The keys are used to lock the battery into place. To remove the battery, turn the key to the "open" position. When riding, ensure that the keys are removed and the battery is firmly locked in place.



## MECHANICAL SAFETY CHECK

Do a visual and mechanical inspection of your Vamoose Electric Cycle before every ride.

- Please review the Pre-Ride Safety Inspection described on pages **30-32** of this Owner's Manual.

## BRAKE CHECK

Check brake operation before each and every ride to ensure optimum performance. In addition, Vamoose Electric Cycles must be inspected and serviced by a qualified cycle mechanic after every 150 kilometers of riding. This inspection and service is important for new cycles as components will go through an initial period of breaking in.

- *Also, see "Bedding-In" procedure on page 27.*



**DISC BRAKE ROTORS CAN BECOME WARM/HOT DURING USE. DO NOT TOUCH WHEN HOT. AS WELL, BRAKES MAY NEED A LONGER DISTANCE TO STOP WHEN WET. BRAKE EARLY AND AVOID SUDDEN STOPS IN INCLEMENT CONDITIONS.**

## SPOKES

Ensure that your spokes are properly maintained with a spoke tensioning completed at each mechanical service of the cycle.



## TIRE AIR PRESSURE

Critical to your fat tire cycle's performance is tire air pressure. Low air pressure in the tires of a fat tire electric cycle can have a material impact on battery life, distance, and probability of a tire puncture. As such, check the tire pressure before every ride. The correct tire pressure will be displayed on the side wall of the tire.

## FRONT SUSPENSION FORK

A suspension fork is made to absorb bump forces while improving the traction and braking control. When in active mode, the fork will rely on "SAG" to keep the front tire in better contact with the ground during braking under most conditions. SAG is the measurement of the amount of suspension fork travel with the rider stationary in their normal riding position. The SAG depends on the position and weight of the rider and should be between 15% and 30% of the fork's max travel (depending on the intended use and preference of the rider). **The suspension is preset from the factory. Please visit a cycle mechanic professional if any adjustments are needed.**

## GEARS

The Vamoose ODIN comes equipped standard with 7 speeds. The gearing is made to provide uphill advantage in the first gear and maximum speed on level or downhill grades in the seventh gear. The rear cassette includes seven sprockets with the largest representing the first gear, while gear seven will have the derailleur positioned around the smallest sprocket. Each position on the gear selector provides a gear change. Please only have a qualified technician make fine tuning adjustments.



**Change gears only while pedaling, but avoid rapid gear changes to ensure the chain stays connected to the front sprocket.**



## CYCLE TRANSPORT

When transporting a Vamoose cycle ensure to use an appropriate carrier capable of handling the weight of the cycle. As well, ensure to remove the battery and cover the cycle with special care to ensure that

all of the electric components (including display, controller, wiring connections and battery connections) are covered from the elements (especially rain) during transport.



### **DISPLAY**

Get to know your display prior to operating the Vamoose Electric Cycle. Although the Vamoose displays are intuitive, it is important to understand the functionality and operation of the display prior to riding.

### **PULLING A TRAILER**

Pulling a trailer, especially a fully loaded trailer, will require additional practice and understanding to operate safely. It is recommended that you **practice pulling the trailer in an area that is free from vehicles, other cyclists, pedestrians, or obstacles to develop the skill required to maneuver and brake safely.**



Although Vamoose Electric Cycles come standard with hydraulic brakes, pulling a heavy load trailer can decrease braking power and lengthen the stopping distance, as well as reduce acceleration and top speeds.

### **KICKSTAND**

All Vamoose cycles come with a kickstand to ensure that the cycles are not laid on the ground, and components such as the derailleur remain in good form.



### **ADDITIONAL PASSENGERS**

Unless otherwise noted, Vamoose Electric Cycles are designed for only one passenger. **DO NOT carry additional passengers.**

### **USE GOOD JUDGMENT**

At all times during the operation of a Vamoose Electric Cycle you must use good judgment. At a minimum, make sure that no straps or loose material (clothing etc.), bags or boxes, or any items are in a position that could be caught in moving components such as the wheels, chain, or handlebars. If you are using a pannier bag or other similar attached bag, ensure that it is secure and stable and not interfering with the operation of the mechanical components of the cycle.

### **HAND THROTTLE CONTROL**

Before you begin riding, turn the main power switch on, then start riding as you would ride a regular, non-motor assisted cycle. After you have begun to ride, slowly twist the throttle towards you. The more you twist the throttle, the more motor power will be applied to the wheels. You may feel the pedals get a “lighter” feel than riding without the motor assisting you. Once you have twisted the throttle all the way, the motor can accelerate you to its full speed of about 32kph or 20mph.



*Fig. 11: Hand Throttle*

### **THROTTLE OVERRIDE**

Engaging the throttle will override the pedal assistance and provide power commensurate to the amount of turn of the throttle - from none, to full power!

### **PEDAL ASSIST (PAS)**

Vamoose cycles come with both pedal assist and throttle capability. The pedal assist mode (PAS) is only active when the pedals are in forward motion. A cadence sensor ring on the bottom bracket spindle rotates and a sensor reads this rotation. To activate, identify the level of pedal assist on the display (1-5,) and begin by first riding as if you are on a normal non-electric cycle. Once the pedals are in motion, the PAS system will activate the motor power. It is suggested that during your initial rides, you use the lower level PAS and work up to the more powerful levels once you are comfortable on the cycle.

### **Free Ride**

All Vamoose cycles are capable of free-riding, that is, powering the cycle with pedal power only.

## **BATTERY AND CHARGER CARE**

Vamoose cycle batteries provide up to 800 charging cycles. However, all lithium ion batteries reduce capacity on each charge. To maintain optimum battery life:

- Keep your battery away from extreme environments. The most suitable temperature for the battery is -10°C to +35°C or 14°F to 95°F. Keep the battery away from heat, fire, or flammable substances and prevent the battery from falling and getting wet. Do not insert metal into the battery.
- Frequent acceleration at full throttle will drain the battery more quickly than you may expect. To conserve battery power, gently apply the throttle, and use lower PAS modes.
- If you are not going to use the battery for a long time, take the battery out of your Vamoose cycle, and store it with 50%-100% battery left. Do not use the battery when it has less than 10% capacity left.
- All Vamoose cycles are splash proof, but not waterproof. Do not put the cycle in water deeper than 7 inches, and ensure that the controller does not get wet.
- If you keep charging your battery for more than 12 hrs and it does not become fully charged, stop charging and contact Vamoose Electric Cycle Ltd.

Proper care and maintenance of the battery will maximize its lifespan and available ride time. Vamoose cycles use Samsung Li-Ion (Lithium Ion) batteries in all of its electric cycles. These are very user friendly batteries when cared for properly.

Please note:

- **FULLY CHARGE BATTERIES BEFORE FIRST USE.** Li-Ion(Lithium Ion) batteries take approximately 4-5 hours to charge.
- Charge batteries at least every 60 days until normal use is resumed.
- Always store cycles with fully charged batteries.
- Never charge the batteries for more than 24 hours
- Always disconnect the charger from the wall outlet and the battery once charging is complete (as indicated by the status on the charger) before storing the cycle.
- Do not store the batteries below 50°Fahrenheit and never allow the batteries to freeze (below 32°Fahrenheit)

- Vamoose cycles are equipped with a 5 minute sleep mode. If no activity is detected after 5 minutes the cycle will go into sleep mode to conserve the battery.
- To Restart, press and hold the power switch. Cycles are not to be stored in the 5 minutes sleep mode. Be sure to turn the power switch "OFF" when the cycle is not in use.
- Always be sure to turn the cycle "OFF" after each use via the ON/OFF power switch. If you have left the power switch on or your product has not been charged for a long period of time, the battery may reach a stage where it will no longer hold charge.
- Be friendly to the environment! Be sure to recycle your old batteries at a local battery recycling center. **Do not throw them in the garbage.**
- Frequent "stops" and "starts" will drain a battery more quickly than sustained, long term use.
- Even with proper care, rechargeable batteries do not last forever.
- Average battery life depends on use and conditions.
- The charger will charge a fully depleted battery in 4-5 hours. The indicator light on the charger will be red when the battery is charging and will turn green when fully charged. Avoid subjecting the battery to high temperatures, such as directly under the sun, for prolonged periods of time.
- Recharge the battery before it becomes completely discharged. Completely discharging the battery will reduce the number of recharging cycles of a battery's life and limit its capacity.
- Never store the battery in a discharged state. After much use, your battery's charge-holding capacity will decrease. If you find that your battery does not hold sufficient charge, please contact your local dealer or Vamoose Electric Cycle Ltd. directly to order a replacement battery.
- If the battery will not be used for an extended period of time, charge it fully and recharge it every 2 months. Store it in a cool, dry place. Your battery is engineered with precision for high capacity and a long, useful life.
- Do not use the battery to power other electrical devices.
- Any improper use or storage of the battery may damage the battery and shorten its life and may cause a fire or an explosion, which may result in injury, death, property damage, and damage or loss resulting therefrom.



If you experience unusual sounds or odors coming from the charger or the battery, unplug the charger immediately and contact Vamoose customer service.

- Recharge the battery after every use.
- Be sure to charge the battery at least once every 60 days, even if the battery is not being used. Doing so will help maximize the life of the battery.
- Always be sure to turn the cycle "OFF" after each use via the ON/OFF power switch.

#### **DO NOTs**

- Do not disassemble or alter the battery or battery charger.
- Do not place the battery near fire or corrosive substances.
- Do not allow any liquids on or inside the battery/charger.
- Do not expose the battery/charger to extreme weather conditions.
- Do not operate the battery/charger if damaged.
- Recharge the battery only with a charger specified by the manufacturer.
- Do not use the battery/charger for any use other than its intended purpose.
- Do not use the battery/charger on non-Vamoose approved products.

## THE FIRST RIDE



It is critical that you become familiar with the operation of the Vamoose Electric Cycle. If you are a first time user of this cycle, we recommend you start with an uncrowded space, away from vehicles, other cyclists, pedestrians, or obstacles etc. to familiarize yourself with the display, controls, features, and performance of the Vamoose Electric Cycle.



Please review the Pre-Ride Safety Inspection described on pages 30-32 of this Owner's Manual.

**NEVER** ... carry a passenger on this cycle. ....

**NEVER** ... modify the cycle with unapproved accessories. ....

**NEVER** ... ride through deep water (it is battery powered after all). ....

**NEVER** ... perform wheelies, jumps or trick stunts (this cycle just isn't made for that type of activity).

**AVOID** ... riding in the rain for extended periods of time (again, it is an electric cycle). ....

**AVOID** ... water contact to the motor, controller, battery and power cables.

**ALWAYS** ... keep both hands on the handlebar. ....

**ALWAYS** ... apply brakes lightly when riding on rocks or loose surfaces. ....

**ALWAYS** ... use caution when going through puddles. ....

**ALWAYS** ... inspect the cycle before riding to ensure a safe ride.



**IF AT ANY TIME YOU NOTICE A PROBLEM, MALFUNCTION OR DAMAGE TO YOUR VAMOOSE ELECTRIC CYCLE STOP RIDING IMMEDIATELY AND TAKE IT TO A PROFESSIONAL Cycle MECHANIC FOR INSPECTION AND SERVICING.**

## Hydraulic Disc Brakes

This Vamoose Electric Cycle comes standard with hydraulic disc brakes for maximum reliability and stopping power. Disc brakes operate by applying pressure to the brake levers which engage the brake pads against the brake rotor, creating friction that slows the wheel. The more pressure that is applied to the brake lever, the more pressure that is generated on the brake rotor, and the faster the cycle will come to a stop.



As a general rule, the rear brake should be engaged first AND during the application of the front brake. Due to the stopping power of the hydraulic brakes, applying only the front brake at high speed may cause the rider to be ejected from the saddle, over the handlebar. Ensuring your weight distribution is in the opposite direction to the breaking force, and applying even pressure to both brake levers when slowing or stopping, is important to the safe operation of the cycle.



Cycles equipped with disc brakes can occasionally make a slight scraping noise when the wheels are turning without the brakes being applied. This is normal.



Fig. 12: Braking components



**NOTE:** Make sure that the brake lever does not contact the handlebar when full hand pressure is applied (figure 12). The contact point should feel firm and solid. If the lever travels all the way to the handlebar or feels spongy, the cycle may require service by a qualified cycle technician.



**If the brakes are not operating correctly, they may require an adjustment by an experienced cycle mechanic.**

## Brake Bedding-In



Vamoose Electric Cycles require a "bedding-in" procedure prior to the first ride to ensure the most consistent, smooth and even braking possible.

For disk brakes, the caliper that squeezes the brake pads on either side of the rotor creates the friction to stop the cycle. Before your first ride, it is important to apply the following bedding-in procedure to ensure a smooth and even coating of the brake pad residue onto the rotor surface. This procedure prevents scratching and scarring on the pads and rotors, and removes any impurities from the brake pad surface.



### STEPS INVOLVED:

Find a safe riding area that will allow for moderate speed. Remain seated during the entire procedure for optimum results.

- Accelerate the cycle to a **moderate speed**, then firmly squeeze the brake levers until you are at walking speed. Repeat this process about twenty times.
- Accelerate the cycle to a **faster speed**, then firmly squeeze the brake levers until you are at walking speed. Repeat this process about ten times.
- Allow the brakes to cool down before your first ride.

**Important Note:** Do not lock up the wheels at any point during the bedding-in procedure.



**DISC BRAKE ROTORS CAN BECOME WARM/HOT DURING USE. DO NOT TOUCH WHEN HOT. AS WELL, BRAKES MAY NEED A LONGER DISTANCE TO STOP WHEN WET. BRAKE EARLY AND AVOID SUDDEN STOPS IN INCLEMENT CONDITIONS.**

# Troubleshooting

## Troubleshooting

If your Vamoose cycle is not working, first check the quick disconnect fittings to make sure they have not come loose or unplugged.

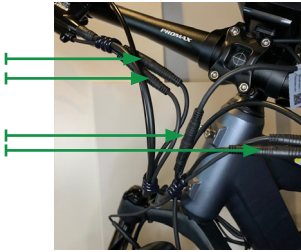

Fig. 13: Disconnect Fittings

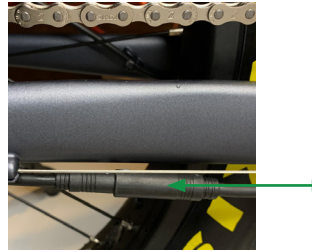

Fig. 14 Motor Disconnect

There are 5 total colored Quick Disconnect fittings to check:

1. Right-hand Throttle - Yellow
2. Left Brake Lever - Red
3. Right Brake Lever - Red
4. Motor - Black 9 Pin
5. C600E Display

Make sure the battery is inserted fully into the cycle. If not fully inserted, the cycle will not receive power and the electronics will not turn on.

If an error occurs in the electronic control system, an error code will appear automatically:

Issue	Description	Solution
The battery charge indicator light is not responsive and the motor does not work.	The battery voltage is low	Immediately charge
	The battery is not providing proper power	Replace the battery
	The battery connection does not work, preventing the battery from being properly secured	Replace the battery
The motor is operating when the throttle is not engaged	The throttle handle is connected incorrectly to the controller	Reconnect per wiring diagram
	The controller is damaged	Replace the controller
The motor stops intermittently	Poor or loose battery connection	Adjust or clean contacts
	The battery moving due to vibration	Check or replace Battery lock
Reduced ride time	The battery is unable to hold charge properly	Replace the battery
	The battery is supplying lower voltage	Battery maintenance or replacement
The battery is not fully charging	The battery is no longer functioning	Replace the battery
	The charger is no longer functioning	Check connections or replace the charger
	Poor contact between the charger plug and the charger socket	Clean or replace the charger socket
The headlight is not working	The headlight switch is not functioning properly	Check the connection and replace the light if required
The controller is no longer functioning	Short-circuit in the controller	Replace the controller

*Table 1: Troubleshooting*

# Pre-Ride Safety Inspection

## MECHANICAL SAFETY CHECK

Routinely check the condition of your cycle. Make sure no fasteners, cables or components have become loose or damaged in any way. As well, perform a visual inspection of the whole cycle before every ride. Inspect the frame for cracks and make sure it is not bent or broken. Also, check the cycle's components including:



### WHEELS

- Check the condition of both tires making sure the tread is in good condition and free from punctures, cracks, and deformations. In addition, ensure that the spokes are tight and not broken.
- Maintain proper tire pressure as indicated on the tire sidewall. Tire pressure is critical to safety, ride enjoyment, and battery life.
- Ensure the wheels are true and properly dished.
- If your cycle has quick release axles, make sure that the locking levers are correctly tensioned and in the closed position.



### BATTERY

- Establish that the batteries are in good operating condition and kept fully charged and properly secured and locked when on the cycle.
- Make certain that the battery is inserted securely: push the battery into its holder until it clicks into the lock. Remove the key from the lock and pull the battery to check if it has indeed locked into place.
- Check the charge status of the battery. Familiarize yourself with battery charging and storage best practices.



### BRAKES SYSTEM

- Ensure both front and rear brakes are in proper working condition, are not excessively worn, and are in the correct working position relative to the rims.
- Pull both brake levers. You should feel an obvious pressure point and the levers should not be able to touch the handle.

### LIGHTING

- Check if the front and rear lights are working properly. Do not cover any lighting or reflectors (if applicable).



### **DISPLAY**

- Check that the front and rear mechanisms are adjusted and functioning properly, with the brake levers attached to the handlebar. Make sure the shift levers and cables are properly lubricated.



### **CABLES**

- Look out for any loose cables. Make sure the male and female plugs are properly connected.
- There should be no strain on any wiring near the fork when turning the handlebar from left to right.
- Verify that the wiring on the frame is secure and free from any moving parts that may damage the wiring. This includes any wires and brake cable lines near the wheel or other moving parts.

### **KICKSTAND**

- Make sure that the kickstand is tightly secured, and not rubbing against the ground or tires.
- Do not sit on a cycle with a kickstand engaged.

### **STEERING**

- Ensure that the handlebar and stem are correctly adjusted and tightened, are set correctly in relation to the forks and direction of travel, and allow for proper steering.
- Check that the headset locking mechanism is properly adjusted and tightened.

### **CHAIN, PEDALS, CRANKS & BEARING**

- Ensure the chain is oiled, clean and runs smoothly (take extra care in wet or dusty conditions).
- Verify that the pedals are securely tightened to the crank. Check headset, wheel bearings, pedal bearings and top and bottom bracket bearings. Confirm the crank is not bent and is secure to the axle.
- Extra care is required in wet or dusty conditions.

### **FRAME AND FORK**

- Check that the frame and fork are not bent or broken. If either are bent or broken, they must be replaced.

### **MOTOR DRIVE ASSEMBLY AND THROTTLE**

- Ensure all motor drive components are correctly mounted and functioning properly



## ***Limited Warranty***

Vamoose Electric Cycle Ltd. (hereinafter referred to as "Vamoose") hereby gives notice to the owner or the operator (hereinafter referred to as the "Owner") of the cycle (hereinafter referred to as the "Cycle") of the provisions of a limited warranty offered by Vamoose to the Owner following the purchase of the Cycle. Vamoose warrants that it has the legal right to sell the Cycle, and that title to the Cycle will be free and clear of all encumbrances and interests as at the date the Owner purchases the Cycle. Vamoose disclaims all other expressed or implied warranties including, but not limited to, the implied warranties of merchantability and fitness for a particular purpose.

All other warranties are those of the relevant supplier or manufacturer and Vamoose hereby assigns to the extent possible in law all rights of Vamoose in any warranty provided to it to the Owner any and all warranties relating to the Cycle provided to it by its suppliers and manufacturers. If any such warranty is not assignable by Vamoose to the Owner, then Vamoose shall: (i) hold such warranty for the benefit of the Owner; and (ii) at the request, sole expense and under the direction of the Owner, take such reasonable action as may be required to preserve or enforce such warranty. All remedies receivable under such warranty may be received by the Owner, or by Vamoose for the benefit of the Owner.

The Owner acknowledges and agrees that its sole and exclusive remedy from Vamoose for any default of the warranty to title of the Cycle will be the replacement or refund of the applicable purchase price of the Cycle. Vamoose's liability, if any, to the Owner is limited to recovery of the original purchase price of the Cycle, or replacement at the same value.

This Limited Warranty is conditional upon the Owner's proper handling, maintenance, and storage of the Cycle, in accordance with the instructions herein contained in this Owner's Manual. Any negligence or non-compliance with the instructions herein contained in this Owner's Manual will render this Limited Warranty null and void.

## ***Frequently Asked Questions***

### **Q. How long does it take to fully charge the battery?**

**A.** Depends on the state of discharge, and the power of the charger. Most Vamoose chargers are between 2-3A and will charge the battery in around 4-5 hours if completely discharged. However, more powerful chargers (including a 5A model) will charge the battery faster. That said, the size of the battery also makes a difference with smaller batteries charging faster than larger ones.

### **Q. What are the energy costs for a Vamoose electric cycle?**

**A.** Vamoose electric cycles are extremely efficient. So much so, that if you charged the cycle every day of the year, it would only cost you about \$35. On average, the cost per full charge will be close to 10 cents. Yep, 10 cents.

### **Q. Can I ride up hills and against strong headwinds on my electric cycle?**

**A.** You betcha! One of the main advantages of cycling on a Vamoose electric cycle is that it increases your average speed when tackling inclines and headwinds. If you provide a reasonable amount of effort, you should be able to tackle anything from a 1 in 10 (10%) gradient up to a 1 in 7 (14%) gradient. Your new Vamoose electric cycle can tackle some of the most arduous journeys with relative ease. You will be amazed!

### **Q. Do I need to pedal an electric cycle?**

**A.** No, all of the Vamoose cycles can be propelled by throttle alone. That said, the value of a pedal assist cycle is that it has a motor to provide support to your efforts. The more pedaling and less power used, the longer the battery life.

### **Q. What happens if I get a flat tire?**

**A.** The tires on our cycles are the same as conventional cycle tires. Simply replace the tube with a tube of the right size and inflate it. No special tires or parts will be needed.

### **Q. What happens when I use the brakes under powered assistance?**

**A.** The motor automatically shuts off power once the brakes lever is activated. This safety feature provides the most optimum situation for braking, protects the motor during brake application, and is required by law in Canada.

**Q. How far will a Vamoose take me?**

**A.** Vamoose cycles are outfitted with large batteries that will take you a great distance. However, the distance available for travel is highly dependent on a number of factors including: motor use, battery size, weight of the rider, type of terrain (steep hills going up vs down), wind resistance, tire air pressure (this is critical), external temperature, and of course, how much pedaling you are doing. That all said, on average a standard calculation for distance is to take the Amp Hours and divide by 20. This will give you an average “miles” calculation. To convert to kilometers, just multiply by approx. 1.6.



***For example:***

The Vamoose ODIN comes standard with a large 48V 15.6Ah battery which provides 748 Amp Hrs.

**748/20x1.6= Approx. 60 km per charge**

**Q. How do I know when the battery is low?**

**A.** All Vamoose cycles come with upgraded displays that provide a visible indicator of battery life. Try not to run the batteries to empty before recharging, but know that these are cycles and are operational without power assist – just pedal to where you can recharge!

**Q. Do I have to wait for the battery to empty before I charge it?**

**A.** No. The batteries we use are Lithium-ion batteries which do not suffer from ‘memory effect’. This means that there is no need to discharge a battery completely before you recharge it again. You can partially recharge the battery at any time without reducing its voltage or lifespan. We recommend recharging the battery after every use, regardless of how far you rode.

**Q. Can I put a trailer on a Vamoose cycle?**

**A.** Yes, you can add a trailer to your Vamoose. Whether you are looking to haul groceries or children, a Vamoose cycle can pull a trailer.

**Q. Can I put a Vamoose on a cycle rack?**

**A.** Yes, just make sure that the cycle rack can hold the weight of a Vamoose. We advise taking the battery off to make it easier to lift and to keep the battery safe.

# Notes

A series of horizontal dotted lines for writing notes.



# VAMOOSÉ

electric cycle ltd.

