



Luath Owner's manual

ISLABIKES

www.islabikes.co.uk

Setting up your Islabike

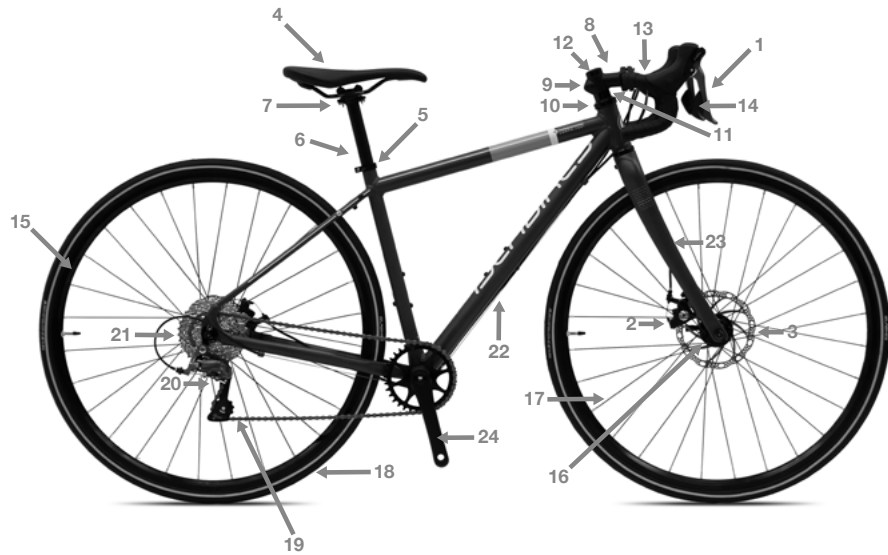

- | | |
|---------------------------|---------------------|
| 1. Brake levers | 13. Handlebars |
| 2. Brake calipers | 14. STI Lever |
| 3. Rotors | 15. Rim |
| 4. Saddle | 16. Hubs |
| 5. Saddle clamp | 17. Spokes |
| 6. Seatpost | 18. Tyres |
| 7. Seatpost clamp | 19. Chain |
| 8. Stem | 20. Rear derailleur |
| 9. Stem bolts | 21. Cassette |
| 10. Headset | 22. Frame |
| 11. Headset spacers | 23. Fork |
| 12. Headset adjuster bolt | 24. Cranks |

Step 1 of 6

Remove front wheel and fork packaging



1. Remove front wheel protection packaging.



2. Remove fork protector.

Step 2 of 6

Install quick release and secure front wheel in fork



1. Install front quick release (QR) skewer from pedal box.

⚠ Ensure QR skewer springs orientation is correct.

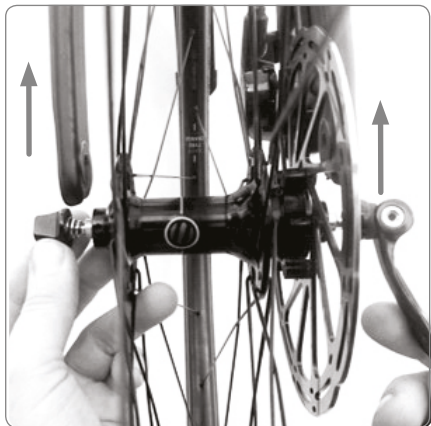
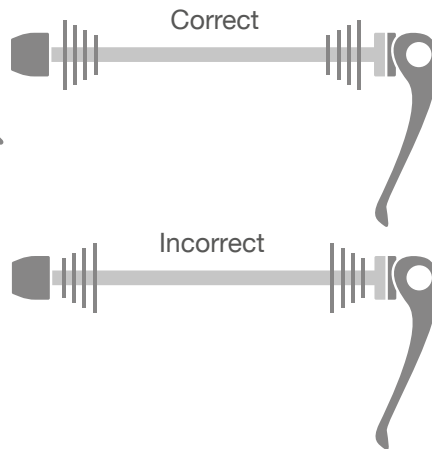

2. Put front wheel into the fork. Ensure (QR) lever is not on gear side. Check this matches the rear wheel.

Step 2 of 6

Install quick release and secure front wheel in fork continued



3. Hold QR lever in fully 'open' position and turn nut clockwise. **Do not fully tighten nut.**



4. Clamp the QR to fully closed position in line with the fork.

ⓘ The QR lever should start to feel tight at 90 degrees as you close – if it is too tight or too loose you can adjust by holding lever 'open' again and turning nut.

⚠ Check front wheel is correctly installed. Firstly, lift the front end of the bike off the ground by the handlebars and strike the top of the wheel firmly with the palm of your hand. Secondly, push and pull the wheel from side to side. If there is no movement from either of these actions the wheel is installed correctly.





Step 3 of 6

Handlebar setup

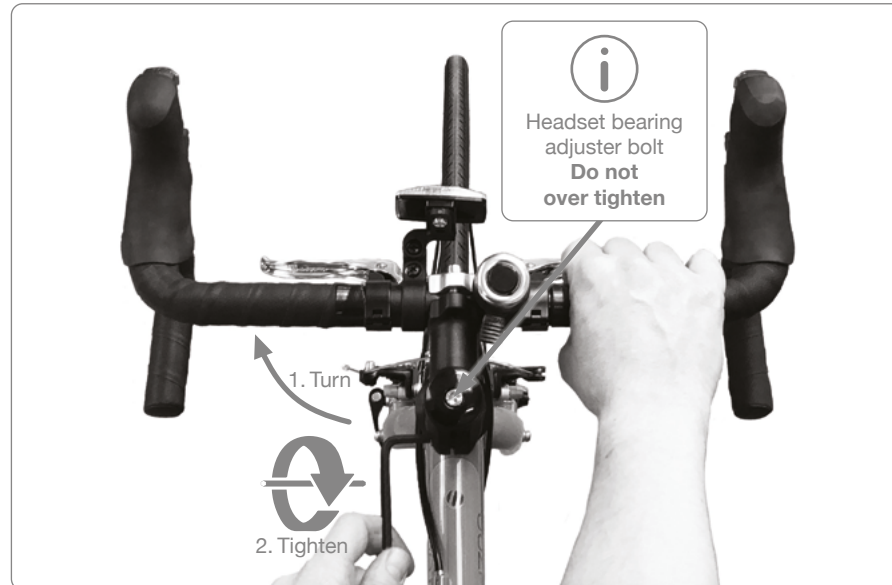
(Only required if mudguards are fitted)



1. Turn handlebars clockwise and align with front wheel.
2. Tighten the stem clamp bolt Max. 7Nm.



-  Note: Do not over tighten headset adjuster bolt. This bolt pre-loads the bearings.
-  The fork steerer tube is carbon fibre construction, which can be seriously damaged by over tightening. **DO NOT EXCEED** Max Torque.
-  Failure to correctly tighten stem clamp bolt may result in serious injury or death. If in doubt, please consult our technical support team on +44 (0) 1584 708 383 or email techsupport@islabikes.co.uk.
-  Before riding check front brake operation is correct. To check this, apply both the front and rear brake, they should feel the same. Secondly, push the bike forward whilst holding the front brake to ensure it is working.

Step 4 of 6

Pedal installation

-  All pedals are supplied in pairs with a specific left and right pedal. This is to prevent the pedals from undoing as you turn the cranks with your feet.
-  Please ensure that you have identified the left and right pedal before installation to avoid damaging the crank arm.

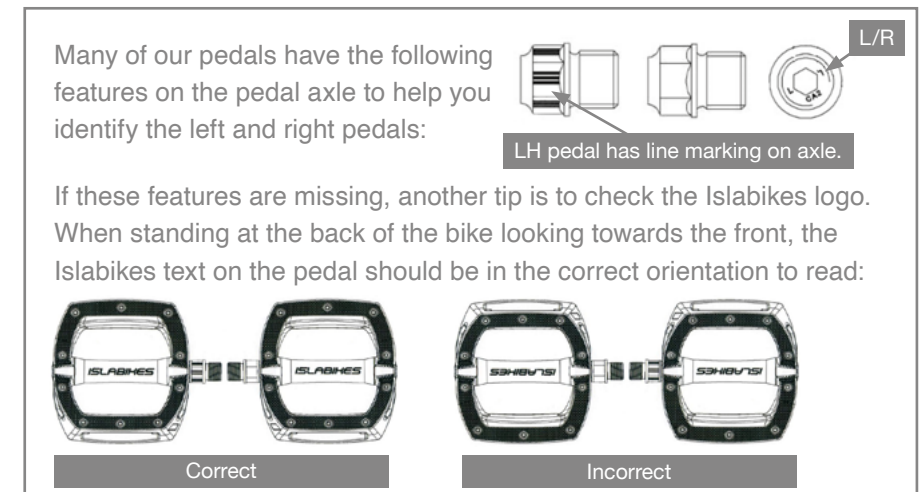

1. Left pedal

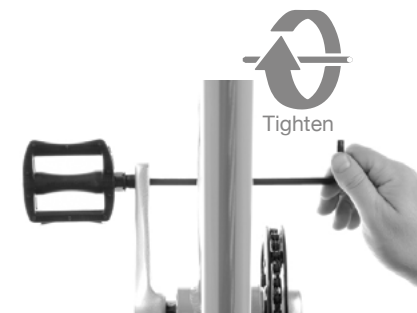

2. Right pedal

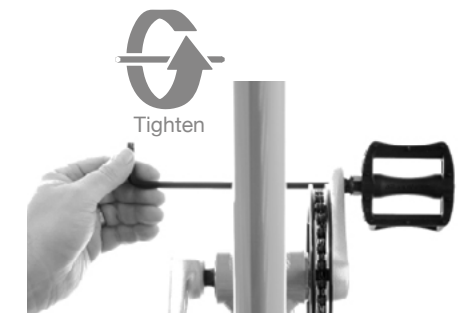

1. Left pedal – rotate pedal axle **clockwise** towards front of bike
 2. Right pedal – rotate axle **anti-clockwise** towards front of bike
- Tighten max. 30Nm**

Step 5 of 6

Adjust saddle height



1. Loosen seatpost-clamp
2. Move to desired height
3. Tighten clockwise max. 4Nm



Seatposts are clearly marked with minimum insertion mark.
Please do not raise saddle above this line.

Step 6 of 6

Brake pad bed-in

It is important to bed-in your new brake pads to achieve optimal performance. The pad bed-in process transfers an even amount of material from the pad to the rotor to increase friction. Correct pad bed-in will increase pad longevity and reduce the likelihood of brake fade and noise.









To safely achieve optimal results, accelerate the bike to a moderate speed (10mph/16kph), then apply the brakes evenly without skidding until you are at walking speed. Ensure you remain seated and release the brakes while you are still moving to prevent coming to a complete stop. Repeat approximately 10 times. Next, perform the same steps but at a faster speed, repeating 5-6 times.

Important: Do not lock up the wheels at any point during the bed-in procedure to allow even material build up on the rotor. Allow the brakes to cool prior to any additional riding. If you require further information about your brakes, contact our technical support team on +44 (0) 1584 708 383 or email techsupport@islabikes.co.uk.

Ready to ride





Safety first

Before you head off please read our advice for safe cycling.

-  Ensure that your helmet is adjusted correctly in accordance with the manufacturer's instructions.
-  Ensure you are wearing sturdy footwear and nothing can become entangled in the pedal or drivetrain.
-  Ensure that you familiarise yourself with your new bicycle in a safe environment. We pride ourselves on light action brakes. Check you can come to a stop safely using the brakes.
-  Adult supervision at all times for young children.
-  Your Islabike is set up so that the right-hand brake lever operates the front brake. Where the destination country drive on the right the right hand brake lever will operate the rear brake.
-  Be aware braking performance and grip will be drastically reduced in wet conditions.
-  Ride carefully on busy streets or highways.
-  Always observe national legal requirements if riding on public roads. If you are cycling in any other countries or in the EU, please check national guidelines.

Ready to ride

Safety first

-  It is important that your bike is regularly maintained. It should be inspected if an accident occurs.
-  We do not recommend that a bicycle trailer or trailer bicycle is fitted to this bicycle.
-  Your bike is fitted with mounting points for a luggage rack, but we do not recommend fitting a child seat.
-  The moving parts on your bike present a danger of entrapment. Particular care should be taken with the chain when riding and maintaining your bicycle.
-  Handlebar ends can become exposed from repeated contact with the ground or heavy fall. Never ride a bike with an unplugged handlebar end. You can buy replacement handlebar grips on our website www.islabikes.co.uk or call +44 (0) 1584 708 383.

Usage guidelines



Your Luath has been designed to be ridden on paved, unpaved and gravel roads with moderate gradients. Contact with irregular terrain and loss of tyre contact with the ground may occur. Drops are to be limited to less than 15cm. The maximum safe combined rider and luggage weight limit limits are as follows:

- Luath 24 = 52kg
- Luath 26 = 54kg
- Luath 700 Small = 65kg
- Luath 700 Large = 75kg



Nothing lasts forever, including your bike. When the useful life of your bike or its components are over, continued use is hazardous. Materials and components may react to wear or stress fatigue in different ways. If the design life of a component has been exceeded it may suddenly fail, possibly causing injuries to the rider. Every bike and its components parts have a finite life. The length of that life will vary with the construction and materials used in the frame and components. Your bike and its components are subject to fatigue. With enough use at high enough loads cracks can develop that could lead to failure. Cracks, scratches or a change of colour could indicate that the design life of the component has been reached and it should be replaced. Extra care should be taken when inspecting parts that are subject to high levels of stress.



Please note your bike is not intended for the following types of riding:

- Mountain biking
- Dirt jumping
- BMX
- Four cross
- Downhill
- Slalom.

Usage guidelines

Factors that can reduce product lifespan include:

- Impacts to the bike from crashes, bumps or jumps.
- Exceeding the maximum weight limit for the bike.
- High mileage/usage.
- Environmental conditions (unusually damp/saline(salty) atmosphere, muddy or sandy conditions).
- Poor maintenance and use out of correct adjustment.
- Unsympathetic riding style.

Factors that can increase product lifespan include:

- Regularly cleaning and maintaining your bike.
- No impacts to the bike from crashes, bumps or jumps.
- Observing the maximum weight limit for the bike.
- Environmental conditions (dry, clean, non-corrosive environment).
- Sympathetic riding style.



It is not possible to make a bike that is impervious to damage. If you crash, damage or use the bike beyond its limitations, there is a higher risk of failure which could result in serious injury or death. Bikes that are used competitively should be subject to more frequent and rigorous checks. Take particular care to check the frame tube junctions and welds as well as all the components for damage or excessive wear. If in any doubt, please contact our technical support team on +44 (0) 1584 708 383 or email techsupport@islabikes.co.uk. Or take it to a qualified cycle mechanic for inspection.

Guarantee

Your Islabike comes with a 5-year guarantee on frame and forks and a 2-year guarantee on parts. This covers faulty manufacturing but not normal wear and tear. This guarantee only applies to the original purchaser of the bike.

Your statutory rights are not affected by the guarantee.

Our clearance bikes have the following guarantees, these apply to the original purchaser and are only valid within the UK.

Ex-display / Demo: 5-years frame and forks / 2-years parts
Second hand: 12-months frame and forks



Our bikes are not guaranteed for racing in sanctioned or competitive events. The use of a bicycle in hazardous conditions including changeable and uneven surfaces can put high, unpredictable loads on the bicycle and its components. Lack of rider skill and experience can further increase these loads leading to the possibility of serious damage to the bicycle and/or injury to the rider. If you choose to participate in these events then please carry out more frequent and thorough maintenance and checks, including regularly inspecting the frame, fork, stem, cranks and handlebars for signs of damage. Discontinue use immediately if anything untoward is spotted and contact our technical support team on +44 (0) 1584 708 383 or email techsupport@islabikes.co.uk.

Maintenance

Keeping your bike clean and maintained comes with many benefits. Not only will your Islabike perform better but it will be safer, last longer and look great. To do this we have listed some regular checks to help you along the way. Of course, if you are unsure of anything we strongly recommend you seek professional advice or contact our technical support team on +44 (0) 1584 708 383 or email techsupport@islabikes.co.uk.

Firstly, moving parts on your bicycle will need lubricating from time to time. Weather conditions are generally the biggest factor that determine frequency of maintenance and lubrication. However, it is also heavily dependent on the frequency, type and duration of riding.

Component	Lubricant	Frequency
Chain	Oil	Weekly or after washing / rain
Gear cables	Oil	Monthly or after washing / rain
Wheel bearings	Grease	6 months
Headset	n/a	Sealed bearings
Bottom bracket	n/a	Sealed bearings

Brakes

One of the most important safety features of your Islabike. It is a good habit to check the brakes on a regular basis. This should be done depending on the type, frequency or duration of riding. If your bike has not been used for a period of time, we recommend a quick check before riding.



Safety check

Before every ride:

- Spin wheel to be sure rotor is undamaged and aligned.
- Check brake pad thickness, if pads look less than 1mm replace.
- Check cable and housing for fraying, excessive friction or damage.
- Ensure that all cables are secured to frame and/or fork can not contact tyres.
- Pull on one brake at a time and check pads contact disc evenly and levers do not feel spongy.

If in doubt please contact our technical support team on +44 (0) 1584 708 383 or email techsupport@islabikes.co.uk.

Brake pad adjustment

Your pads will wear during normal use. You can adjust your pads using the pad adjuster and the cable barrel adjuster. As you adjust, make sure there is an equal pad clearance of 0.3mm on both sides of the rotor.

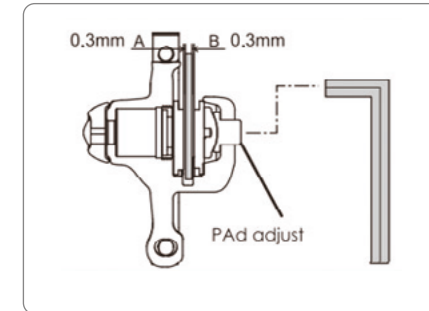

1. Adjust stationary caliper at hub side using 5mm allen key. Turn pad adjustment screw clockwise to move closer to rotor.

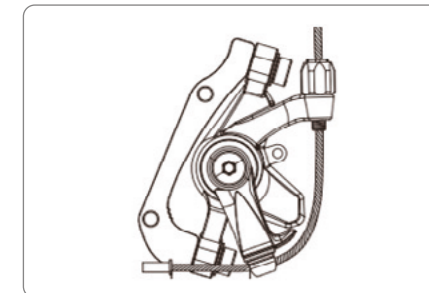

2. Adjust cable barrel adjustment.

Brake pad wear

Brake pads do not last forever. Eventually they will need replacing. This will depend on the type, frequency and duration of riding. Brake pads must be replaced if the total thickness of the backing plate and pad friction material is less than 2.5mm.

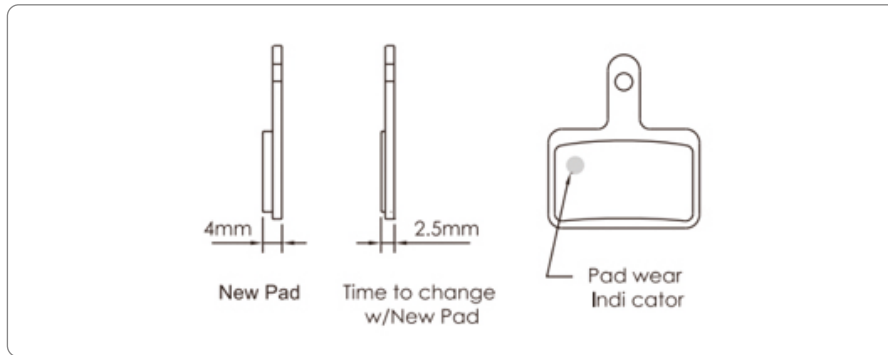

⚠ Pads fitted as standard are organic compound. We recommend replacing with the same compound to maintain performance.

⚠ Pads and rotor must be kept clean and free from oil or grease contamination. If pads become contaminated replace them with a new set. A contaminated rotor should be cleaned with a detergent solution, rinsed thoroughly and dried.

⚠ Compression less or Kevlar cable housing **MUST** be used if optimum braking performance is desired.

Brake pad replacement

1. Remove wheel from bike.

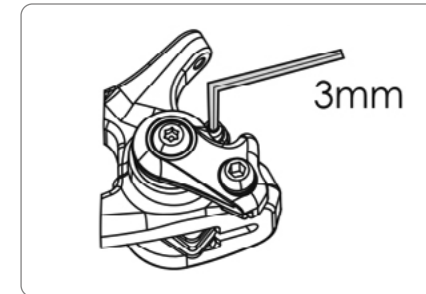

2. Remove brake pad retainer cotter pin and then retainer bolt using 3mm allen key – be careful not to lose these.

3. Pull pads from bottom of caliper to remove.

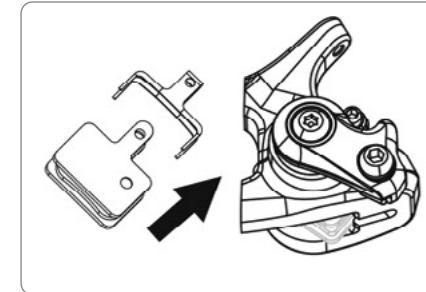

4. Install new pads and spring assembly into the caliper.

5. Reinstall brake pad retainer bolt and re-attach cotter pin.

6. Adjust brakes using barrel adjuster and pad adjuster.

⚠ Always conduct brake pad bed in procedure after pad replacement and exercise caution as braking performance will be reduced temporarily with new pads.

Tyres and Tubes

Tyre wear – Regularly check tyres for general wear and tear. Overtime your tyres will become more worn and can become more susceptible to punctures.

Tyre pressure – Regularly check your Islabike tyre pressure as they slowly go down over time. To check, simply push your thumb hard onto the tyre or use a pressure gauge fitted to most quality bicycle track pumps. If you can touch the rim this probably needs some more air.



You should not exceed the maximum tyre pressure printed on the sidewall of the tyre. We recommend approx. 70% of the maximum tyre pressure illustrated on your tyre. To inflate presta valves you must first open the valve by unscrewing and tapping the valve end to relieve it if stuck. Inflate to correct pressure and then carefully re-tighten to close the valve.

Easy-fit rims – Your bike is installed with Islabikes easy-fit rims to allow easier inner tube changes in the event of a puncture.



When re-inflating a tyre or after changing an inner tube ensure tyre is seated centrally on rim and continually check around the rim as you inflate to ensure rim is seated correctly and prevent tyre blowing off rim.

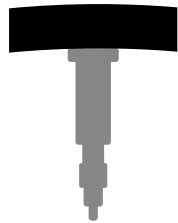

Valve closed

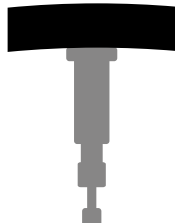

Valve open

Use our guide to inflate your tyres: <https://www.islabikes.co.uk/knowledge/technical-support/maintaining-your-islabike/>

Wheels

Rim trueness – Depending on the type of riding you do your Islabikes bikes wheels may become untrue or damaged when riding. This means they will not spin straight and will wobble. If for any reason they are untrue our wheels can be easily repaired, please contact our technical support team on +44 (0) 1584 708 383 or email techsupport@islabikes.co.uk.

Hubs – Your hubs are fitted with cup and cone bearings. Although they are sealed water and grit can enter your hubs and cause premature wear. To prolong the life and keep them running smooth and efficient we recommend annual maintenance and re-greasing of hub bearings.

Drivetrain

The drivetrain is a category of components made up of the chain, cranks, cassette and pedals. These components work together to drive your Islabike forward and are crucial in maintaining the optimum performance and life of your Islabike. To keep these running smoothly we advise the following.

Chain cleaning and lubricating – We recommend cleaning & lubricating your chain weekly or after washing/rain. Simply use soapy water to wipe over your chain and rear derailleur then dry with a cloth. Then gently apply any general bicycle oil direct whilst simultaneously turning the cranks backwards to ensure full chain coverage. Wipe off any surplus oil with a cloth.

Gears

Your Islabike has had its gears adjusted prior to delivery. These should be checked periodically or after a fall to ensure they are operating correctly. Quick check:



Ensure your rear derailleur hanger is not twisted or bent. Place your Islabike in gear 1 or the biggest sprocket and look from the rear. Look out to see if the rear derailleur is fouling the spokes or looks twisted.

If the gears are not working correctly contact our technical support team on +44 (0) 1584 708 383 or email techsupport@islabikes.co.uk.

Recommended torque settings

All stem bolts	7Nm
Saddle clamp bolts	7Nm
Seatpost collar bolt	4Nm
Crank bolts	35Nm
Pedals	30Nm
Caliper bolts	9Nm
Rotor bolts	6Nm
Rear derailleur	6Nm

Accessories

 Propstands must be used by the rider's foot. The hinge mechanism could represent a finger trap hazard.

Spares and replacement parts

We carry stock of replacement parts for your Islabike including inner tubes, tyres and grips. Please visit our website for a list of readily available spares.

We only recommend using genuine parts for safety critical components e.g. brake cables, brake blocks and bolts.

If you can't find what you are looking for or are unsure of any compatibility for older models, please contact our technical support team by phone or email.

techsupport@islabikes.co.uk

+44 (0) 1584 708 383

For technical support and cycling advice please see the knowledge area of our website. www.islabikes.co.uk/knowledge/

Frame number

Please make a record of your frame number. This is a combination of letters and numbers unique to your bike stamped to the underside of the frame. This is required by police and insurance companies in case of loss.



ISLABIKES
www.islabikes.co.uk