

BRISK[®]
USA ENTERPRISES, LLC



- *More Power*
- *Faster Acceleration*
- *Durability*

BRISK SILVER *Racing*



MAGNETIC
TERMINAL NUT
FOR EASY REMOVAL

HIGH DIELECTRIC
STRENGTH
INSULATOR

ONE PIECE SHELL
CONSTRUCTION
*does not separate upon
removal like other brands*

SILVER CENTER
ELECTRODE
*the Best Electrical and
Thermal Conductor*

GAPABLE CUTBACK
GROUND STRAP
CONFIGURATION
*easy to gap, excellent spark exposure,
great flame-front propagation*



Black Ignition Boot
2004-2008 3 Valve Ford Engine

- **3VR10S**
- **3VR12S**
- **3VR14S**
- **3VR17YS**

Brown Ignition Boot
BMW for the 2006-2010 3 Valve Ford Engine

- **XOR12YS**
- **XOR14YS**



Justin Burcham



Vinny Barber

CYLINDER HEAD CROSS REFERENCE GUIDE

CYLINDER HEAD MANUFACTURER	SPEC SHEET RECOMMENDATION	BRISK EQUIVALENT RACING PLUGS
AIR FLOW RESEARCH		
205cc LS1 Mongoose Street Head	AC 41-974 Platinum	GR15YS, GOR15LGS, GR15ZC, GOR15YTE
225cc LS1 Mongoose Strip Head	AC 41-974 Platinum	GR15YS, GOR15LGS, GR15ZC, GOR15YTE
180cc SBC Street Head	AC FR3LS	DR15YS, DOR15LGS, DR15ZC, DOR15YTE
180cc LT1 Street Head	AC FR3LS	DR15YS, DOR15LGS, DR15ZC, DOR15YTE
195cc SBC Street Head	AC FR3LS	DR15YS, DOR15LGS, DR15ZC, DOR15YTE
195cc LT4 Street Head	AC FR3LS	DR15YS, DOR15LGS, DR15ZC, DOR15YTE
305/315/325/335/345/357cc Magnum BBC	CHA C59C, AUT 3932	D10S, DO10LGS-T (index free plug)
165/185cc SBF Outlaw Street Heads	AUT 3924	DR15YS, DOR15LGS, DR15ZC, DOR15YTE
205/224cc SBF Outlaw Race Heads	AUT 3922	DR14YS, or DR14S (non-projected tip)
165/185cc SBF Street/Strip Outlaw Heads	AUT 3924	DR15YS, DOR15LGS, DR15ZC, DOR15YTE
BRODIX		
BBC, Big Brodie Series	NGK B9ES	gas L11SL, L10SL Alcohol
C.A.R.B. Legal Heads	CHA 14YC or AUT 3924	DR15YS, DOR15LGS, DR15ZC, DOR15YTE
DART		
Big Chief, All	.750" reach, gasket, CHA C57C/C57YC	D08S, DO10LGS-T (index free plug)
Big M- Head	.750" reach, gasket, CHA C59C/C59YC Street RC12YC	D10S, Street app. DR15YS
Ford 20 Degree	.750" reach, gasket, CHA C59C/C59YC	D10S, DO10LGS-T (index free plug)
Iron Eagle, 308cc & 345cc BBC	.750" reach, gasket, CHA C59C/C59YC Street RC12YC	D10S, Street app. DR15YS
Iron Eagle, 23 Degree, 180, 200, 215, 230cc SBC	Angle or Straight, 460" Reach, Tapered Seat, CHA V59C/V59YC	H08S, HO11LGS-T (index free plug)
Iron Eagle S/S	Straight, 460" Reach, Tapered Seat, CHA RV12YC/AQC R44TS	HR17YTE (stubby), HOR15LGS, HR14YS
Little Chief, 11 Degree SBC Head	CHA C57C/C57YC	D08S, DO10LGS-T (index free plug)
Pro 1, 23 Degree SBC & BBC all cc's	CHA C59C/C59YC	D10S, DO10LGS-T (index free plug)
Race Series, 220cc SBC Head	CHA C59C/C59YC	D10S, DO10LGS-T (index free plug)
Race Series, 18 Degree BBC Head	CHA C57C/C57YC	D08S, DO10LGS-T (index free plug)
EDELBROCK		
All Except Flathead		DR15YS, DOR15LGS, DR15ZC, DOR15YTE
FORD RACING PERFORMANCE PARTS		
GT-40 "Turbo-Swirl" Alum. Cyl Heads		DR14YS, DOR14LGS, DR14ZC
GT-40X "Turbo-Swirl" Alum Cyl Heads		DR14YS, DOR14LGS, DR14ZC
"Sportsman" Short Track Cast Iron Cyl Heads		HR14YS, HOR14LGS, HO14LGS
"Z" Aluminum Heads		DOR15LGS
Robert Yates Alum. Cyl Heads		L- style sparkplug (13/16hex, 14mm, gasket)
"High Port" Yates Head		L- style sparkplug (13/16hex, 14mm, gasket)
High Port Head for all out Performance		L- style sparkplug (13/16hex, 14mm, gasket)
Super Cobra Jet Cylinder Heads		DR14YS, DOR14LGS, DR14ZC
PRO TOPLINE		
Iron Lightning, Pro Lightning	CHA V55C, V57C	H08S, HO11LGS-T (index free plug)
Other	CHA C55C, C57C	D08S, DO10LGS-T (index free plug)
TRICK FLOW		
Track Heat Alum. Cyl. Heads for SB Ford	AC FR3LS, AUT 3924, NGK 7373	DR15YS, DOR15LGS, DR15ZC, DOR15YTE
18 Degree Alum. Heads for SB Chevy	CHA C57C, NGK R5671A-10	D08S, DO10LGS-T (index free plug)
23 Degree Alum. Heads for SB Chevy	AC FR3LS, AUT 3924, NGK FR5, CHA RC	DR15YS, DOR15LGS, DR15ZC, DOR15YTE
R-Series Cyl. Head for BB Chevy	AUT 3922	DR14YS, DOR14LGS, DR14ZC
WORLD		
Windsor Jr		HR14YS, HOR14LGS, HO14LGS
Windsor Jr. Lite		DR15YS, DR14YS, DOR14LGS, DR14ZC
Windsor Sr. Lite		DR15YS, DR14YS, DOR14LGS, DR14ZC
Roush 200 Cast Iron		HR14YS, HOR14LGS, HO14LGS
Torquer 440 Aluminum		D10S, DO10LGS-T (index free plug), D08S
Sportsman II Lite		DR15YS, DR14YS, DOR14LGS, DR14ZC
S/R		HR17YTE (stubby), HOR15LGS, HR14YS
S/R Torquer		HR17YTE (stubby), HOR15LGS, HR14YS
Sportsman II		HR17YTE (stubby), HOR15LGS, HR14YS
Motown 205/220		HR17YTE (stubby), HOR15LGS, HR14YS
Motown 220 Lite		DR15YS, DR14YS, DOR14LGS, DR14ZC
Merlin II Oval & Rect. Port		HR17YTE (stubby), HOR15LGS, HR14YS
320cc & 345cc Merlin		DR15YS, DR14YS, DOR14LGS, DR14ZC

WARNING: Cross reference is provided for convenience only!
Prior installation please confirm spark plug recommendation with cylinder Head manufacturer and/or engine builder/tuner

BRISK SPARK PLUGS IDENTIFICATION SYSTEM

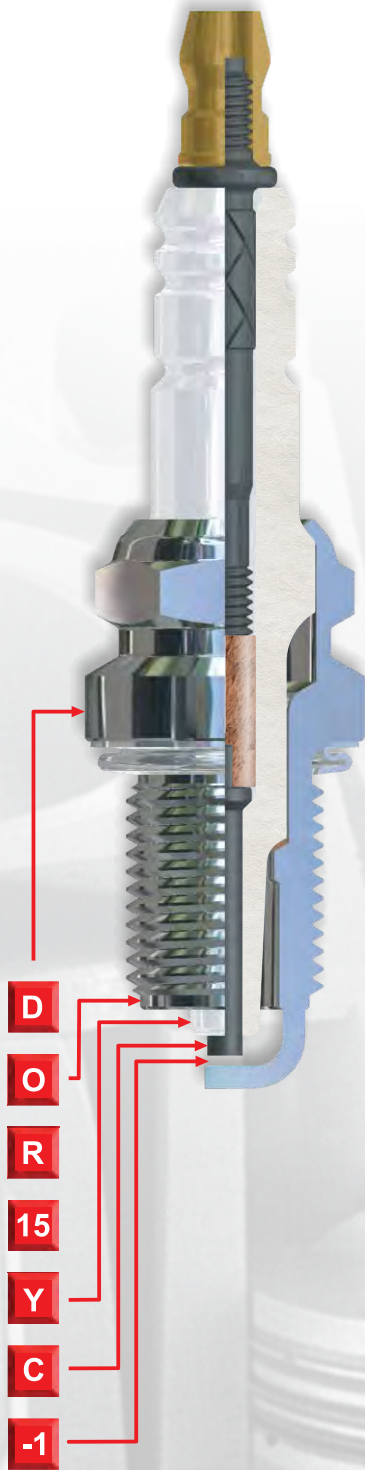

D

METALL SHELL DIMENSIONS

A B D E F G H L N NA R T

TYPE				Conical seat	Gasket seat
A	M10x1	19mm	16mm		•
B	M12x1.25	19mm	17,5mm		•
D	M14x1.25	19mm	16mm		•
E	M14x1.25	26,5mm	16mm		•
F	M18x1.5	11,2mm	21mm	•	
G	M14x1.25	17,5mm	16mm	•	
H	M14x1.25	11,2mm	16mm	•	
J	M14x1.25	9,5mm	21mm		•
K	M14x1.25	9,5mm	21mm		•
L	M14x1.25	19mm	21mm		•
N	M14x1.25	12,7mm	21mm		•
P	M14x1.25	9,5mm	19mm		•
R	M14x1.25	25mm	16mm	•	
U	M14x1.25	7,8mm	16mm	•	
NA	M10x1	12,7mm	16mm		•
T	M10x1	12,7mm	16mm		•
M	M12x1.25	26,5mm	16mm		•

O

METALL SHELL PROJECTED INTO COMBUSTION CHAMBER

- Complies with relevant ISO standard
- Does not comply with relevant ISO standard

R

INTERFERENCE SUPPRESSION

- No Interference suppression
- Interference suppression
- Resistor reducing electrode burn-off

15

HEAT RANGE

19 18 17 16 15 14 12 11 10 09 08
Hot ← → Cold

Y

SPARK GAP DESIGN

- Not projected Insulator nose
- Projected Insulator nose
- Extremely projected Insulator nose
- Extended Insulator nose and two ground electrodes
- Extended insulator nose and three ground electrodes
- Not projected insulator nose and ring-shaped electrode
- Extremely projected Insulator nose and ring-shaped spark gap
- Two auxiliary electrodes on the insulator nose and ring-shaped electrode gap
- One auxiliary electrode on the insulator nose and three ground electrodes
- Extremely projected insulator nose and three ground electrodes

C

ELECTRODE MATERIAL

- Nickel-alloy centre electrode
- Copper cored centre electrode or electrode made of special alloyed Itrium with cooper
- Copper cored centre and ground electrode alloyed with yttrium
- Silver centre electrode
- Centre electrode with platinum contact
- Centre and ground electrode with platinum contact
- Centre electrode with platinum pad and yttrium alloyed ground electrode
- Iridium pad on the centre electrode

-1

SPARK GAP

- 0.4-0.9 mm
- 1.0-1.1 mm
- 1.3 mm
- 0.9 mm - Special design
- Special design

Silver

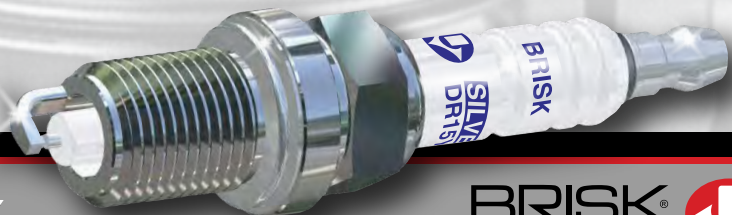

BRISK
USA ENTERPRISES, LLC





A

obj. č.

GAP (mm)

MANUFACTURER HEAT RANGES									
BRISK	8	10	12	14	15	17			
NGK	10	9	8	7	6	5			
DENSO	31	27	24	22	20	16			

BRISK®

USA ENTERPRISES, LLC



THREAD	REACH	HEXAGON	SEAT	DESIGN	RESISTOR	PROJECTED
--------	-------	---------	------	--------	----------	-----------

A

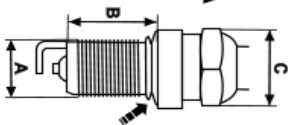

A - M10x1.00
B - 19mm (3/4")
C - 16mm (5/8")
 10-15 Nm
7-11 lb.ft.

silver



..S	A10S	1495	0.7	10mm	19mm-3/4"	16mm-5/8"	gasket	Silver Center Electrode	no	no
	A08S		0.7	10mm	19mm-3/4"	16mm-5/8"	gasket	Silver Center Electrode	no	no
	AR10S	1517	0.7	10mm	19mm-3/4"	16mm-5/8"	gasket	Silver Center Electrode	yes	no
	AR08S	1516	0.7	10mm	19mm-3/4"	16mm-5/8"	gasket	Silver Center Electrode	yes	no



..YS	A14YS		0.7	10mm	19mm-3/4"	16mm-5/8"	gasket	Silver Center Electrode	no	yes
	A12YS		0.7	10mm	19mm-3/4"	16mm-5/8"	gasket	Silver Center Electrode	no	yes
	AR14YS	1519	0.7	10mm	19mm-3/4"	16mm-5/8"	gasket	Silver Center Electrode	yes	yes
	AR12YS	1518	0.7	10mm	19mm-3/4"	16mm-5/8"	gasket	Silver Center Electrode	yes	yes

AR08GS

1515

10mm 19mm-3/4" 16mm-5/8" gasket Silver-Surface Discharge yes no

premium

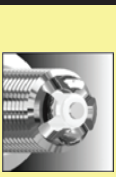



..LGS	AOR12LGS	1514		10mm	19mm-3/4"	16mm-5/8"	gasket	Lamborghini Design	yes	semi
	AOR14LGS	3090		10mm	19mm-3/4"	16mm-5/8"	gasket	Lamborghini Design	yes	semi
	AOR10LGS	1513		10mm	19mm-3/4"	16mm-5/8"	gasket	Lamborghini Design	yes	no

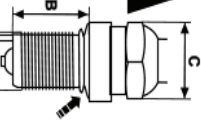

..ZS	AR12ZS	1208		10mm	19mm-3/4"	16mm-5/8"	gasket	Multi-Spark	yes	yes
	AR10ZS	1181		10mm	19mm-3/4"	16mm-5/8"	gasket	Multi-Spark	yes	yes
	AR08ZS	1180		10mm	19mm-3/4"	16mm-5/8"	gasket	Multi-Spark	yes	yes

NA



A - M10x1.00
B - 12.7mm (1/2")
C - 16mm (5/8")
 10-15 Nm
7-11 lb.ft.

silver



..YS	NAR15YS			10mm	12.7mm-1/2"	16mm-5/8"	gasket	Silver Center El.	yes	yes
	NAR14YS			10mm	12.7mm-1/2"	16mm-5/8"	gasket	Silver Center El.	yes	yes
	NAR12YS			10mm	12.7mm-1/2"	16mm-5/8"	gasket	Silver Center El.	yes	yes

NAR

premium

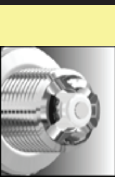

..LGS	NAOR15LGS			10mm	12.7mm-1/2"	16mm-5/8"	gasket	Lamborghini Design	yes	semi
	NAOR14LGS			10mm	12.7mm-1/2"	16mm-5/8"	gasket	Lamborghini Design	yes	semi
	NAOR12LGS			10mm	12.7mm-1/2"	16mm-5/8"	gasket	Lamborghini Design	yes	semi
	NAOR10LGS			10mm	12.7mm-1/2"	16mm-5/8"	gasket	Lamborghini Design	yes	no



B

TYP
obj. č.

MANUFACTURER HEAT RANGES	
BRISK	8 10 12 14 15 17
NGK	10 9 8 7 6 5
DENSO	31 27 24 22 20 16

BRISK

USA ENTERPRISES, LLC



THREAD REACH HEXAGON SEAT DESIGN RESISTOR PROJECTED

GAP (mm)

Model	Gap (mm)	Thread	Reach	Hexagon	Seat	Design	Resistor	Projected			
super	..C	B14C	1548	0.7	12mm	19mm-3/4"	18mm-11/16"	gasket	Copper Alloy Electrode	no	no
	B12C	1547	0.7	12mm	19mm-3/4"	18mm-11/16"	gasket	Copper Alloy Electrode	no	no	
	B10C	1549	0.7	12mm	19mm-3/4"	16mm-5/8"	gasket	Copper/Yttrium Alloy El.	no	no	
	B10C	1511	0.7	12mm	19mm-3/4"	18mm-11/16"	gasket	Copper Alloy Electrode	no	no	
	..YC	B14YC	1487	0.6	12mm	19mm-3/4"	16mm-5/8"	gasket	Copper Alloy Electrode	no	yes
	B12YC	1469	0.7	12mm	19mm-3/4"	16mm-5/8"	gasket	Copper Alloy Electrode	no	yes	
	B15YC	1527	0.6	12mm	19mm-3/4"	16mm-5/8"	gasket	Copper Alloy Electrode	yes	yes	
	B14YC	1526	0.6	12mm	19mm-3/4"	16mm-5/8"	gasket	Copper Alloy Electrode	yes	yes	
	B14YC-9	1569	0.9	12mm	19mm-3/4"	16mm-5/8"	gasket	Copper Alloy Electrode	yes	yes	
	B12YC	1523	0.6	12mm	19mm-3/4"	16mm-5/8"	gasket	Copper Alloy Electrode	yes	yes	
silver	..S	B14S	1504	0.7	12mm	19mm-3/4"	16mm-5/8"	gasket	Silver Center Electrode	no	no
	B12S	1504	0.7	12mm	19mm-3/4"	16mm-5/8"	gasket	Silver Center Electrode	no	no	
	B10S	1502	0.7	12mm	19mm-3/4"	16mm-5/8"	gasket	Silver Center Electrode	no	no	
	B08S	1525	0.7	12mm	19mm-3/4"	16mm-5/8"	gasket	Silver Center Electrode	no	no	
	B14S	1525	0.7	12mm	19mm-3/4"	16mm-5/8"	gasket	Silver Center Electrode	yes	no	
	B12S	1522	0.7	12mm	19mm-3/4"	16mm-5/8"	gasket	Silver Center Electrode	yes	no	
	B10S	1520	0.7	12mm	19mm-3/4"	16mm-5/8"	gasket	Silver Center Electrode	yes	no	
	..YS	BR10YS	1509	0.7	12mm	19mm-3/4"	16mm-5/8"	gasket	Silver Center Electrode	yes	yes
	BR10YS-9	1521	0.9	12mm	19mm-3/4"	16mm-5/8"	gasket	Silver Center Electrode	yes	yes	
	BR12YC-9	1568	0.9	12mm	19mm-3/4"	16mm-5/8"	gasket	Copper Alloy Electrode	yes	yes	
platinum	..YPY	BR12YPY	1524	0.7	12mm	19mm-3/4"	16mm-5/8"	gasket	Platin / Yttrium	yes	yes
	premium	..LGS	BOR14LGS	3093	12mm	19mm-3/4"	16mm-5/8"	gasket	Lamborghini Design	yes	semi
		BOR12LGS	3092	12mm	19mm-3/4"	16mm-5/8"	gasket	Lamborghini Design	yes	semi	
		BOR10LGS	3091	12mm	19mm-3/4"	16mm-5/8"	gasket	Lamborghini Design	no	semi	
..ZS		BR12ZS	1161	12mm	19mm-3/4"	16mm-5/8"	gasket	Multi-Spark	yes	yes	
BR10ZS	1159	12mm	19mm-3/4"	16mm-5/8"	gasket	Multi-Spark	yes	yes			
BR08ZS	12mm	19mm-3/4"	16mm-5/8"	gasket	Multi-Spark	yes	yes				
..ZC	BR14ZC	1165	12mm	19mm-3/4"	16mm-5/8"	gasket	Multi-Spark Copper	yes	yes		
BR12ZC	1163	12mm	19mm-3/4"	16mm-5/8"	gasket	Multi-Spark Copper	yes	yes			

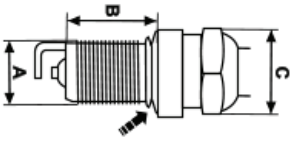

A - M12x1.25
B - 19mm (3/4")
C - 16mm (5/8")





C

TYP obj. c

GAP (mm)

MANUFACTURER HEAT RANGES	
BRISK	8 10 12 14 15 17
NGK	10 9 8 7 6 5
DENSO	31 27 24 22 20 16

BRISK
USA ENTERPRISES, LLC



..YS

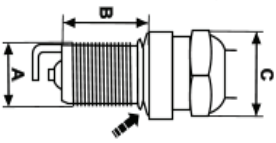

- A - M10x1.00
- B - 26.5mm (1.05")
- C - 14mm (9/16")

! 10-15 Nm
7-11 lb.ft.

silver

CR10YS

THREAD 10mm REACH 26.5mm-1.05" HEXAGON 14mm-9/16" SEAT gasket DESIGN Silver Center Electrode RESISTOR yes PROJECTED yes



D

MANUFACTURER HEAT RANGES	
BRISK	8 10 12 14 15 17
NGK	10 9 8 7 6 5
DENSO	31 27 24 22 20 16

BRISK
USA ENTERPRISES, LLC



PROJECTED

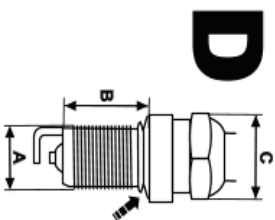

A - M14x1.25
B - 19mm (3/4")
C - 16mm (5/8")

20-30 Nm
14-22 lb.ft

D	TYP	obj. c.	GAP (mm)		THREAD		REACH	HEXAGON	SEAT	DESIGN	RESISTOR	PROJECTED
			1.1	0.8	14mm	16mm						
platinum	..YP	DR17YP	1402	0.8	14mm	16mm	19mm-3/4"	16mm-5/8"	gasket	Double Platinum	yes	yes
	DR17YP-1	1403	1.1	14mm	16mm	19mm-3/4"	16mm-5/8"	gasket	Double Platinum	yes	yes	
	DR15YP	1400	0.8	14mm	16mm	19mm-3/4"	16mm-5/8"	gasket	Double Platinum	yes	yes	
	DR15YP-1	1401	1.1	14mm	16mm	19mm-3/4"	16mm-5/8"	gasket	Double Platinum	yes	yes	
	DR14YP	1425	0.8	14mm	16mm	19mm-3/4"	16mm-5/8"	gasket	Double Platinum	yes	yes	
	DR14YP-1	1426	1.1	14mm	16mm	19mm-3/4"	16mm-5/8"	gasket	Double Platinum	yes	yes	
	DR12YP	1508	0.8	14mm	16mm	19mm-3/4"	16mm-5/8"	gasket	Double Platinum	yes	yes	
	..LGS	DOR17LGS	3027		14mm	16mm	19mm-3/4"	16mm-5/8"	gasket	Lamborghini Design	yes	yes
	DOR15LGS	3026		14mm	16mm	19mm-3/4"	16mm-5/8"	gasket	Lamborghini Design	yes	yes	
	DOR15LGS-T	3025		14mm	16mm	19mm-3/4"	16mm-5/8"	gasket	Lambo Design small gap	yes	yes	
premium	..ZC	DOR14LGS	3032		14mm	16mm	19mm-3/4"	16mm-5/8"	gasket	Lamborghini Design	yes	yes
	DOR14LGS-T	3032		14mm	16mm	19mm-3/4"	16mm-5/8"	gasket	Lambo Design small gap	yes	yes	
	DOR12LGS	3032		14mm	16mm	19mm-3/4"	16mm-5/8"	gasket	Lamborghini Design	yes	yes	
	DOR11LGS	3032		14mm	16mm	19mm-3/4"	16mm-5/8"	gasket	Lamborghini Design	yes	no	
	DOR10LGS	3032		14mm	16mm	19mm-3/4"	16mm-5/8"	gasket	Lamborghini Design	yes	no	
	DO 10LGS-T	3032		14mm	16mm	19mm-3/4"	16mm-5/8"	gasket	Lambo Design small gap	no	no	
	DOR08LGS	3032		14mm	16mm	19mm-3/4"	16mm-5/8"	gasket	Lamborghini Design	yes	no	
	DR15ZC	1126		14mm	16mm	19mm-3/4"	16mm-5/8"	gasket	Multi-Spark	yes	yes	
	DR15ZC-1	1134		14mm	16mm	19mm-3/4"	16mm-5/8"	gasket	Multi-Spark	yes	yes	
	DR14ZC	1124		14mm	16mm	19mm-3/4"	16mm-5/8"	gasket	Multi-Spark	yes	yes	
iridium	..ZS	DR14ZC-1	1232		14mm	16mm	19mm-3/4"	16mm-5/8"	gasket	Multi-Spark	yes	yes
	DR12ZC	1125		14mm	16mm	19mm-3/4"	16mm-5/8"	gasket	Multi-Spark	yes	yes	
	DR12ZC-1	1133		14mm	16mm	19mm-3/4"	16mm-5/8"	gasket	Multi-Spark	yes	yes	
	DR10ZC	1130		14mm	16mm	19mm-3/4"	16mm-5/8"	gasket	Multi-Spark	yes	yes	
	DR10ZC-1	1135		14mm	16mm	19mm-3/4"	16mm-5/8"	gasket	Multi-Spark	yes	yes	
	DR12ZS	1204		14mm	16mm	19mm-3/4"	16mm-5/8"	gasket	Multi-Spark	yes	yes	
	DR10ZS	1203		14mm	16mm	19mm-3/4"	16mm-5/8"	gasket	Multi-Spark	yes	yes	
	DR08ZS	1202		14mm	16mm	19mm-3/4"	16mm-5/8"	gasket	Multi-Spark	yes	yes	
	DR08GS	1202		14mm	16mm	19mm-3/4"	16mm-5/8"	gasket	Multi-Spark	yes	yes	
	..GS	DR08GS	1202		14mm	16mm	19mm-3/4"	16mm-5/8"	gasket	Surface Discharge	yes	no
..IR	DOR15IR	1442	0.8	14mm	16mm	19mm-3/4"	16mm-5/8"	gasket	Iridium Center Electrode	yes	special-semi	
DOR14IR	1441	0.8	14mm	16mm	19mm-3/4"	16mm-5/8"	gasket	Iridium Center Electrode	yes	special-semi		
DOR12IR	1441	0.8	14mm	16mm	19mm-3/4"	16mm-5/8"	gasket	Iridium Center Electrode	yes	special-semi		
DOR10IR	1441	0.8	14mm	16mm	19mm-3/4"	16mm-5/8"	gasket	Iridium Center Electrode	yes	special-semi		
DOR08IR	1441	0.8	14mm	16mm	19mm-3/4"	16mm-5/8"	gasket	Iridium Center Electrode	yes	special-semi		
DOX12IRY	1441	0.8	14mm	16mm	19mm-3/4"	16mm-5/8"	gasket	Iridium / Yttrium	yes	extra projected		



E

TYP obj. č.

MANUFACTURER HEAT RANGES	
BRISK	8 10 12 14 15 17
NGK	10 9 8 7 6 5
DENSO	31 27 24 22 20 16

BRISK
USA ENTERPRISES, LLC



RESISTOR PROJECTED

GAP (mm)

		THREAD		REACH		HEXAGON		SEAT		DESIGN		RESISTOR		PROJECTED	
<p>E</p> <p>A - M14x1.25 B - 26.5mm (1.05") C - 16mm (5/8")</p> <p>20-30 Nm 14-22 lb.ft</p>	super	..YC	ER15YC-1		14mm	26.5mm-1.05"	16mm-5/8"	gasket	Copper Center Electrode	yes		yes			
	silver	..S	ER14S ER12S ER10S		14mm	26.5mm-1.05"	16mm-5/8"	gasket	Silver Center Electrode	yes		no			
					14mm	26.5mm-1.05"	16mm-5/8"	gasket	Silver Center Electrode	yes		no			
					14mm	26.5mm-1.05"	16mm-5/8"	gasket	Silver Center Electrode	yes		no			
	premium	..LGS	EOR15LGS EOR14LGS		14mm	26.5mm-1.05"	16mm-5/8"	gasket	Lamborghini Design	yes		yes			
					14mm	26.5mm-1.05"	16mm-5/8"	gasket	Lamborghini Design	yes		yes			
					14mm	26.5mm-1.05"	16mm-5/8"	gasket	Lamborghini Design	yes		yes			



G

TYP obj. c.





GAP (mm)

MANUFACTURER HEAT RANGES	
BRISK	8 10 12 14 15 17
NGK	10 9 8 7 6 5
DENSO	31 27 24 22 20 16

BRISK
USA ENTERPRISES, LLC

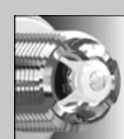

THREAD REACH HEXAGON SEAT DESIGN RESISTOR PROJECTED

		THREAD		REACH		HEXAGON		SEAT		DESIGN		RESISTOR		PROJECTED			
super	..YC		G17YC	1368	0.7	14mm	18mm-.708"	16mm-5/8"	tapered	Copper Alloy Electrode	no	yes					
			G15YC	1336	0.7	14mm	18mm-.708"	16mm-5/8"	tapered	Copper Alloy Electrode	no	yes					
			G14YC	1376	0.7	14mm	18mm-.708"	16mm-5/8"	tapered	Copper Alloy Electrode	no	yes					
			G12YC	1483	0.7	14mm	18mm-.708"	16mm-5/8"	tapered	Copper Alloy Electrode	no	yes					
			GR19YC-C-1	1477	1.1	14mm	18mm-.708"	16mm-5/8"	tapered	Copper Alloy Electrode	yes	yes					
			GR17YC	1389	0.7	14mm	18mm-.708"	16mm-5/8"	tapered	Copper Alloy Electrode	yes	yes					
			GR17YC-C-1	1419	1.1	14mm	18mm-.708"	16mm-5/8"	tapered	Copper Alloy Electrode	yes	yes					
			GR15YC	1362	0.7	14mm	18mm-.708"	16mm-5/8"	tapered	Copper Alloy Electrode	yes	yes					
			GR15YC-C-1	1383	1.1	14mm	18mm-.708"	16mm-5/8"	tapered	Copper Alloy Electrode	yes	yes					
			GR14YC	1378	0.7	14mm	18mm-.708"	16mm-5/8"	tapered	Copper Alloy Electrode	yes	yes					
			silver	..YS		G12S			14mm	18mm-.708"	16mm-5/8"	tapered	Silver Center Electrode	no	no		
						G08S			14mm	18mm-.708"	16mm-5/8"	tapered	Silver Center Electrode	no	no		
GR14S	1493	0.7				14mm	18mm-.708"	16mm-5/8"	tapered	Silver Center Electrode	yes	no					
GR12S						14mm	18mm-.708"	16mm-5/8"	tapered	Silver Center Electrode	yes	no					
G14YS	1492	0.7				14mm	18mm-.708"	16mm-5/8"	tapered	Silver Center Electrode	no	yes					
GR17YS						14mm	18mm-.708"	16mm-5/8"	tapered	Silver Center Electrode	yes	yes					
GR15YS						14mm	18mm-.708"	16mm-5/8"	tapered	Silver Center Electrode	yes	yes					
GR14YS						14mm	18mm-.708"	16mm-5/8"	tapered	Silver Center Electrode	yes	yes					
GR15YS-9	1577					14mm	18mm-.708"	16mm-5/8"	tapered	Silver Center Electrode	yes	yes					
GR19YP-5	1478	1.5				14mm	18mm-.708"	16mm-5/8"	tapered	Single Platin	yes	yes					
GR17YP-5	1475	1.5				14mm	18mm-.708"	16mm-5/8"	tapered	Single Platin	yes	yes					
GR17YP-3	1474	1.3				14mm	18mm-.708"	16mm-5/8"	tapered	Single Platin	yes	yes					
GR17LP-5	1479	1.5	14mm	18mm-.708"	16mm-5/8"	tapered	Single Platin Extra Proj.	yes	yes								
GR15YP-1			14mm	18mm-.708"	16mm-5/8"	tapered	Single Platin	yes	yes								
platinum	..LGS		GOR19LGS	3083		14mm	18mm-.708"	16mm-5/8"	tapered	Lamborghini Design	yes	yes					
			GOR17LGS			14mm	18mm-.708"	16mm-5/8"	tapered	Lamborghini Design	yes	yes					
			GOR15LGS			14mm	18mm-.708"	16mm-5/8"	tapered	Lamborghini Design	yes	yes					
			GOR15LGS-T			14mm	18mm-.708"	16mm-5/8"	tapered	Lambo Design small gap	yes	yes					
			GOR14LGS	3080		14mm	18mm-.708"	16mm-5/8"	tapered	Lamborghini Design	yes	yes					
			GOR14LGS-T			14mm	18mm-.708"	16mm-5/8"	tapered	Lambo Design small gap	yes	yes					
			GO11LGS-T			14mm	18mm-.708"	16mm-5/8"	tapered	Lambo Design small gap	no	no					
			GR15ZC	1155		14mm	18mm-.708"	16mm-5/8"	tapered	Multi-Spark	yes	yes					
			GR15ZC-C-1	1158		14mm	18mm-.708"	16mm-5/8"	tapered	Multi-Spark	yes	yes					
			GR14ZC	1153		14mm	18mm-.708"	16mm-5/8"	tapered	Multi-Spark	yes	yes					
			GR14ZC-C-1	1157		14mm	18mm-.708"	16mm-5/8"	tapered	Multi-Spark	yes	yes					
			GR12ZC	1152		14mm	18mm-.708"	16mm-5/8"	tapered	Multi-Spark	yes	yes					
GR12ZC-C-1	1156		14mm	18mm-.708"	16mm-5/8"	tapered	Multi-Spark	yes	yes								
extra	..TC		GOR15YTE-3	1.3		14mm	18mm-.708"	16mm-5/8"	tapered	Triple Ground El. Yttrium	yes	yes					
			GO15YTE-1	1.1		14mm	18mm-.708"	16mm-5/8"	tapered	Triple Ground El. Yttrium	no	yes					
			GOR14DC			14mm	18mm-.708"	16mm-5/8"	tapered	Dual Ground El. Copper	yes	yes					

G

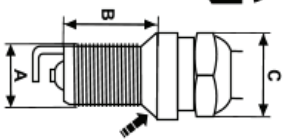

A - M14x1.25
B - 18mm (.708")
C - 16mm (5/8")

20-30 Nm
14-22 lb.ft



H

MANUFACTURER HEAT RANGES	
BRISK	8 10 12 14 15 17
NGK	10 9 8 7 6 5
DENSO	31 27 24 22 20 16

MANUFACTURER HEAT RANGES	
BRISK	8 10 12 14 15 17
NGK	10 9 8 7 6 5
DENSO	31 27 24 22 20 16

TYP obj. c.

THREAD

REACH

HEXAGON

SEAT

DESIGN

RESISTOR

PROJECTED

HR17YTE-1	1.0	14mm	12.7mm-1/2"	16mm-5/8"	tapered	Copper Yttrium -Stubby	yes	yes
HR17YTE-1	1.0	14mm	12.7mm-1/2"	16mm-5/8"	tapered	Copper Yttrium -Stubby	yes	yes
HO15YTE-1	1.0	14mm	12.7mm-1/2"	16mm-5/8"	tapered	Copper Yttrium -Stubby	no	yes

HR14YS	14mm	12.7mm-1/2"	16mm-5/8"	tapered	Silver Center Electrode	yes	yes
H14VS	14mm	12.7mm-1/2"	16mm-5/8"	tapered	Silver Center Electrode	no	yes
H08S	14mm	12.7mm-1/2"	16mm-5/8"	tapered	Silver Center Electrode	no	no

HR14YS	14mm	12.7mm-1/2"	16mm-5/8"	tapered	Silver Center Electrode	yes	yes
H14VS	14mm	12.7mm-1/2"	16mm-5/8"	tapered	Silver Center Electrode	no	yes
H08S	14mm	12.7mm-1/2"	16mm-5/8"	tapered	Silver Center Electrode	no	no

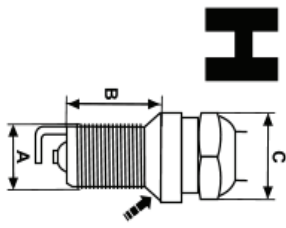

H

A - M14x1.25
 B - 12.7mm (1/2")
 C - 16mm (5/8")

10-20 Nm
 7-14 lb.ft.

extra silver premium

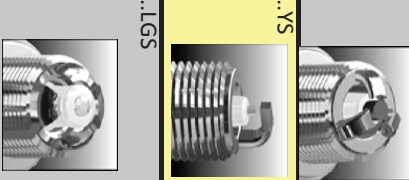

HOR17LGS	3084	14mm	12.7mm-1/2"	16mm-5/8"	tapered	Lamborghini Design	yes	no
HOR14LGS	3085	14mm	12.7mm-1/2"	16mm-5/8"	tapered	Lamborghini Design	yes	yes
HOR17LGS	3086	14mm	12.7mm-1/2"	16mm-5/8"	tapered	Lamborghini Design	yes	yes
HOR15LGS		14mm	12.7mm-1/2"	16mm-5/8"	tapered	Lamborghini Design	yes	yes
HOR12LGS		14mm	12.7mm-1/2"	16mm-5/8"	tapered	Lamborghini Design	no	yes
HO14LGS		14mm	12.7mm-1/2"	16mm-5/8"	tapered	Lamborghini Design	no	yes
HO12LGS		14mm	12.7mm-1/2"	16mm-5/8"	tapered	Lamborghini Design	no	yes
HO11LGS-T		14mm	12.7mm-1/2"	16mm-5/8"	tapered	Lambo Design small	no	no

HOR17LGS	14mm	12.7mm-1/2"	16mm-5/8"	tapered	Lamborghini Design	yes	no
HOR14LGS	14mm	12.7mm-1/2"	16mm-5/8"	tapered	Lamborghini Design	yes	yes
HOR17LGS	14mm	12.7mm-1/2"	16mm-5/8"	tapered	Lamborghini Design	yes	yes
HOR15LGS	14mm	12.7mm-1/2"	16mm-5/8"	tapered	Lamborghini Design	yes	yes
HOR12LGS	14mm	12.7mm-1/2"	16mm-5/8"	tapered	Lamborghini Design	no	yes
HO14LGS	14mm	12.7mm-1/2"	16mm-5/8"	tapered	Lamborghini Design	no	yes
HO12LGS	14mm	12.7mm-1/2"	16mm-5/8"	tapered	Lamborghini Design	no	yes
HO11LGS-T	14mm	12.7mm-1/2"	16mm-5/8"	tapered	Lambo Design small	no	no

HOR17LGS	14mm	12.7mm-1/2"	16mm-5/8"	tapered	Lamborghini Design	yes	no
HOR14LGS	14mm	12.7mm-1/2"	16mm-5/8"	tapered	Lamborghini Design	yes	yes
HOR17LGS	14mm	12.7mm-1/2"	16mm-5/8"	tapered	Lamborghini Design	yes	yes
HOR15LGS	14mm	12.7mm-1/2"	16mm-5/8"	tapered	Lamborghini Design	yes	yes
HOR12LGS	14mm	12.7mm-1/2"	16mm-5/8"	tapered	Lamborghini Design	no	yes
HO14LGS	14mm	12.7mm-1/2"	16mm-5/8"	tapered	Lamborghini Design	no	yes
HO12LGS	14mm	12.7mm-1/2"	16mm-5/8"	tapered	Lamborghini Design	no	yes
HO11LGS-T	14mm	12.7mm-1/2"	16mm-5/8"	tapered	Lambo Design small	no	no



L

MANUFACTURER HEAT RANGES	
BRISK	8 10 12 14 15 17
NGK	10 9 8 7 6 5
DENSO	31 27 24 22 20 16

MANUFACTURER HEAT RANGES	
BRISK	8 10 12 14 15 17
NGK	10 9 8 7 6 5
DENSO	31 27 24 22 20 16

LR17C	1321	14mm	19mm-3/4"	21mm-13/16"	gasket	Copper Alloy Electrode	no	no
LR15C	1468	14mm	19mm-3/4"	21mm-13/16"	gasket	Copper Alloy Electrode	no	no
LR14C	1344	14mm	19mm-3/4"	21mm-13/16"	gasket	Copper Alloy Electrode	no	no
LR17C	1473	14mm	19mm-3/4"	21mm-13/16"	gasket	Copper Alloy Electrode	yes	no
LR15C	1472	14mm	19mm-3/4"	21mm-13/16"	gasket	Copper Alloy Electrode	yes	no
LR14C	1485	14mm	19mm-3/4"	21mm-13/16"	gasket	Copper Alloy Electrode	yes	no
LR12C	1536	14mm	19mm-3/4"	21mm-13/16"	gasket	Copper Alloy Electrode	yes	no

THREAD

REACH

HEXAGON

SEAT

DESIGN

RESISTOR

PROJECTED

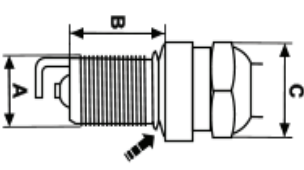

L

A - M14x1.25
 B - 19mm (3/4")
 C - 21mm (13/16")

20-30 Nm
 14-22 lb.ft.

super

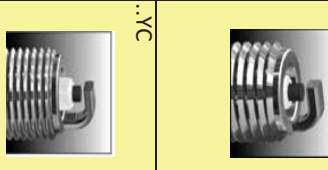

LR17YC	1338	14mm	19mm-3/4"	21mm-13/16"	gasket	Copper Alloy Electrode	no	yes
LR17YC-1	1224	14mm	19mm-3/4"	21mm-13/16"	gasket	Copper Alloy Electrode	no	yes
LR15YC	1313	14mm	19mm-3/4"	21mm-13/16"	gasket	Copper Alloy Electrode	no	yes
LR15YC-1	1429	14mm	19mm-3/4"	21mm-13/16"	gasket	Copper Alloy Electrode	no	yes
LR14YC	1361	14mm	19mm-3/4"	21mm-13/16"	gasket	Copper Alloy Electrode	no	yes
LR12YC	1484	14mm	19mm-3/4"	21mm-13/16"	gasket	Copper Alloy Electrode	no	yes
LR17YC	1322	14mm	19mm-3/4"	21mm-13/16"	gasket	Copper Alloy Electrode	yes	yes
LR17YC-1	1365	14mm	19mm-3/4"	21mm-13/16"	gasket	Copper Alloy Electrode	yes	yes
LR17YC-9	1573	14mm	19mm-3/4"	21mm-13/16"	gasket	Copper Alloy Electrode	yes	yes
LR15YC	1314	14mm	19mm-3/4"	21mm-13/16"	gasket	Copper Alloy Electrode	yes	yes
LR15YC-1	1315	14mm	19mm-3/4"	21mm-13/16"	gasket	Copper Alloy Electrode	yes	yes
LR15YC-9	1572	14mm	19mm-3/4"	21mm-13/16"	gasket	Copper Alloy Electrode	yes	yes
LR14YC	1370	14mm	19mm-3/4"	21mm-13/16"	gasket	Copper Alloy Electrode	yes	yes
LR12YC	1413	14mm	19mm-3/4"	21mm-13/16"	gasket	Copper Alloy Electrode	yes	yes

LR17YC	14mm	19mm-3/4"	21mm-13/16"	gasket	Copper Alloy Electrode	no	yes
LR17YC-1	14mm	19mm-3/4"	21mm-13/16"	gasket	Copper Alloy Electrode	no	yes
LR15YC	14mm	19mm-3/4"	21mm-13/16"	gasket	Copper Alloy Electrode	no	yes
LR15YC-1	14mm	19mm-3/4"	21mm-13/16"	gasket	Copper Alloy Electrode	no	yes
LR14YC	14mm	19mm-3/4"	21mm-13/16"	gasket	Copper Alloy Electrode	no	yes
LR12YC	14mm	19mm-3/4"	21mm-13/16"	gasket	Copper Alloy Electrode	no	yes
LR17YC	14mm	19mm-3/4"	21mm-13/16"	gasket	Copper Alloy Electrode	yes	yes
LR17YC-1	14mm	19mm-3/4"	21mm-13/16"	gasket	Copper Alloy Electrode	yes	yes
LR17YC-9	14mm	19mm-3/4"	21mm-13/16"	gasket	Copper Alloy Electrode	yes	yes
LR15YC	14mm	19mm-3/4"	21mm-13/16"	gasket	Copper Alloy Electrode	yes	yes
LR15YC-1	14mm	19mm-3/4"	21mm-13/16"	gasket	Copper Alloy Electrode	yes	yes
LR15YC-9	14mm	19mm-3/4"	21mm-13/16"	gasket	Copper Alloy Electrode	yes	yes
LR14YC	14mm	19mm-3/4"	21mm-13/16"	gasket	Copper Alloy Electrode	yes	yes
LR12YC	14mm	19mm-3/4"	21mm-13/16"	gasket	Copper Alloy Electrode	yes	yes

LR17YC	14mm	19mm-3/4"	21mm-13/16"	gasket	Copper Alloy Electrode	no	yes
LR17YC-1	14mm	19mm-3/4"	21mm-13/16"	gasket	Copper Alloy Electrode	no	yes
LR15YC	14mm	19mm-3/4"	21mm-13/16"	gasket	Copper Alloy Electrode	no	yes
LR15YC-1	14mm	19mm-3/4"	21mm-13/16"	gasket	Copper Alloy Electrode	no	yes
LR14YC	14mm	19mm-3/4"	21mm-13/16"	gasket	Copper Alloy Electrode	no	yes
LR12YC	14mm	19mm-3/4"	21mm-13/16"	gasket	Copper Alloy Electrode	no	yes
LR17YC	14mm	19mm-3/4"	21mm-13/16"	gasket	Copper Alloy Electrode	yes	yes
LR17YC-1	14mm	19mm-3/4"	21mm-13/16"	gasket	Copper Alloy Electrode	yes	yes
LR17YC-9	14mm	19mm-3/4"	21mm-13/16"	gasket	Copper Alloy Electrode	yes	yes
LR15YC	14mm	19mm-3/4"	21mm-13/16"	gasket	Copper Alloy Electrode	yes	yes
LR15YC-1	14mm	19mm-3/4"	21mm-13/16"	gasket	Copper Alloy Electrode	yes	yes
LR15YC-9	14mm	19mm-3/4"	21mm-13/16"	gasket	Copper Alloy Electrode	yes	yes
LR14YC	14mm	19mm-3/4"	21mm-13/16"	gasket	Copper Alloy Electrode	yes	yes
LR12YC	14mm	19mm-3/4"	21mm-13/16"	gasket	Copper Alloy Electrode	yes	yes



L		MANUFACTURER HEAT RANGES										
		BRISK	8	10	12	14	15	17				
TYP		obj. č.	10	9	8	7	6	5				
		DENSO	31	27	24	22	20	16				

BRISK
USA ENTERPRISES, LLC

..LTC		LR15LTC	1268	0.8	14mm	19mm-3/4"	21mm-13/16"	gasket	Copper Elect. Ext. Proj. Triple Ground Electrodes	yes	yes
-------	--	---------	------	-----	------	-----------	-------------	--------	--	-----	-----

extra-pokra		silver	
..S		..YS	
<p>A - M14x1.25 B - 19mm (3/4") C - 21mm (13/16")</p> <p>20-30 Nm 14-22 lb.ft</p>			
L12S		LR12YS	
L11S		LR17YS-9	
L11SL		LR15YS	
L10S		LR15YS-9	
L10SL		LR14YS	
LR15S		LR12YS	
LR14S		LR17YS-9	
LR12S		LR15YS	
LR12SL		LR15YS-9	
LR11S		LR14YS	
LR11SL		LR12YS	
LR10S			
LR10SL			



L

TYP obj. č.

GAP (mm)

MANUFACTURER HEAT RANGES	
BRISK	8 10 12 14 15 17
NGK	10 9 8 7 6 5
DENSO	31 27 24 22 20 16

BRISK
USA ENTERPRISES, LLC



THREAD REACH HEXAGON SEAT DESIGN RESISTOR PROJECTED

..LGS	LOR17LGS	3030	14mm	19mm-3/4"	21mm-13/16"	gasket	Lamborghini Design	yes	yes
	LOR15LGS	3029	14mm	19mm-3/4"	21mm-13/16"	gasket	Lamborghini Design	yes	yes
	LOR14LGS	3028	14mm	19mm-3/4"	21mm-13/16"	gasket	Lamborghini Design	yes	yes
	LOR12LGS	3034	14mm	19mm-3/4"	21mm-13/16"	gasket	Lamborghini Design	yes	yes

..ZC	LR15ZC	1129	14mm	19mm-3/4"	21mm-13/16"	gasket	Multi-Spark	yes	yes
	LR15ZC-1	1138	14mm	19mm-3/4"	21mm-13/16"	gasket	Multi-Spark	yes	yes
	LR14ZC	1127	14mm	19mm-3/4"	21mm-13/16"	gasket	Multi-Spark	yes	yes
	LR14ZC-1	1136	14mm	19mm-3/4"	21mm-13/16"	gasket	Multi-Spark	yes	yes
	LR12ZC	1128	14mm	19mm-3/4"	21mm-13/16"	gasket	Multi-Spark	yes	yes
	LR12ZC-1	1137	14mm	19mm-3/4"	21mm-13/16"	gasket	Multi-Spark	yes	yes
	LR10ZC	1131	14mm	19mm-3/4"	21mm-13/16"	gasket	Multi-Spark	yes	yes
	LR10ZC-1	1139	14mm	19mm-3/4"	21mm-13/16"	gasket	Multi-Spark	yes	yes

..ZS	L10ZS	1207	14mm	19mm-3/4"	21mm-13/16"	gasket	Multi-Spark	no	yes
	LR12ZS	1206	14mm	19mm-3/4"	21mm-13/16"	gasket	Multi-Spark	yes	yes
	LR10ZS	1205	14mm	19mm-3/4"	21mm-13/16"	gasket	Multi-Spark	yes	yes
	LR08ZS	1205	14mm	19mm-3/4"	21mm-13/16"	gasket	Multi-Spark	yes	yes

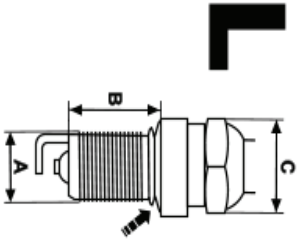

A - M14x1.25
B - 19mm (3/4")
C - 21mm (13/16")
20-30 Nm
14-22 lb.ft

premium



M

TYP obj. C.

GAP (mm)

MANUFACTURER HEAT RANGES	
BRISK	8 10 12 14 15 17
NGK	10 9 8 7 6 5
DENSO	31 27 24 22 20 16

BRISK®

USA ENTERPRISES, LLC



THREAD	REACH	HEXAGON	SEAT	DESIGN	RESISTOR	PROJECTED
12mm	26.5mm-1.05"	14mm-9/16"	gasket	Silver Center Electrode	yes	no
12mm	26.5mm-1.05"	14mm-9/16"	gasket	Silver Center Electrode	yes	no
12mm	26.5mm-1.05"	14mm-9/16"	gasket	Silver Center Electrode	yes	yes
12mm	26.5mm-1.05"	14mm-9/16"	gasket	Silver Center Electrode	yes	yes
12mm	26.5mm-1.05"	14mm-9/16"	gasket	Silver Center Electrode	yes	yes



M

- A - M12x1.25
- B - 26.5mm (1.05")
- C - 14mm (9/16")

15-20 Nm
11-14 lb. ft.

silver

...S



..YS



MR12S

MR10S

MR12YS-1
MR12YS-9
MR10YS

1.1

12mm

26.5mm-1.05"

14mm-9/16"

gasket

Silver Center Electrode

yes

yes

0.9

12mm

26.5mm-1.05"

14mm-9/16"

gasket

Silver Center Electrode

yes

yes



R

TYP obj. ç.

GAP (mm)

MANUFACTURER HEAT RANGES	
BRISK	8 10 12 14 15 17
NGK	10 9 8 7 6 5
DENSO	31 27 24 22 20 16

BRISK
USA ENTERPRISES, LLC



THREAD REACH HEXAGON SEAT DESIGN RESISTOR PROJECTED

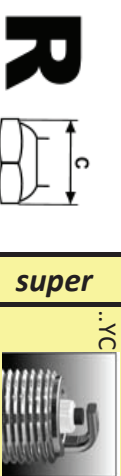

R

A - M14x1.25
B - 25mm (1")
C - 16mm (5/8")

10-20 Nm
7-14 lb.ft.

super



..YC

RR15YC-1
RR15YP-1
1437

1.1

silver



..S

RR14S
RR12S
RR10S

14mm

premium



..YS

RR15YS
RR14YS

14mm

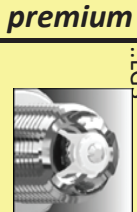

..LGS

ROR15LGS
ROR14LGS

14mm

MANUFACTURER HEAT RANGES

BRISK	8 10 12 14 15 17
NGK	10 9 8 7 6 5
DENSO	31 27 24 22 20 16

THREAD REACH HEXAGON SEAT DESIGN RESISTOR PROJECTED



X

A - M12x1.25
B - 27mm (1.05")
C - 14mm (9/16")

10-12 Nm
7-9 lb.ft.

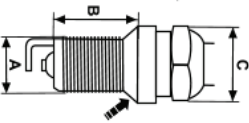

silver



..YS

XOR14YS
XOR14YS-1
XOR12YS
XOR12YS-1

1.0

MANUFACTURER HEAT RANGES

BRISK	8 10 12 14 15 17
NGK	10 9 8 7 6 5
DENSO	31 27 24 22 20 16

THREAD REACH HEXAGON SEAT DESIGN RESISTOR PROJECTED

12mm	27mm-1.05"	14mm-9/16"	tapered	Silver Center Electrode	yes	yes
12mm	27mm-1.05"	14mm-9/16"	tapered	Silver Center Electrode	yes	yes
12mm	27mm-1.05"	14mm-9/16"	tapered	Silver Center Electrode	yes	yes
12mm	27mm-1.05"	14mm-9/16"	tapered	Silver Center Electrode	yes	yes

SPARK PLUG CROSS REFERENCE GUIDE

BOSCH	BRISK
F6DC F6DTC FR6DTC FR6DC F6DP F6DSR FR6DS	DR14YS

BOSCH	BRISK
F7DC FR7LDC F7DTC FR7DTC FR7DC FR7DP	DR15YS

BOSCH	BRISK
F8DC F9DC FR8LDC FR8DC FR9DC FR8DS	DR17YS

F6DTC F6LTCR FR6DCX	DR14YS-9
---------------------------	-----------------

F7DCX F7LDCR FR7DCX FR7DPX F7LTCR FR7LTC	DR15YS-9
---	-----------------

F8LDCR FR8DCX FR8DPX	DR17YS-9
----------------------------	-----------------

BOSCH	BRISK
W6DC W6DTC WR6DTC WR6DC WR6DP W5CS WR6DS	LR14YS

BOSCH	BRISK
W7DC W7DTC WR7DTC WR7DC WR7DP W7DSR WR7DS	LR15YS

BOSCH	BRISK
W8DC W9DC W8DTC W8LTCR W9DTC WR8DC WR9DC WR8DP WR9DP WR8DS WR9DS	LR17YS

W7DTC WR7DCX WR7DPX W7LTCR	LR15YS-9
-------------------------------------	-----------------

W8DTC W8LTCR WR8DCX WR8DPX WR9DPX	LR17YS-9
---	-----------------

BOSCH	BRISK
W4AC W5AC W6BC WR6BC	NR14S

BOSCH	BRISK
W7AC W7BC WR7AC WR7BC	NR15C

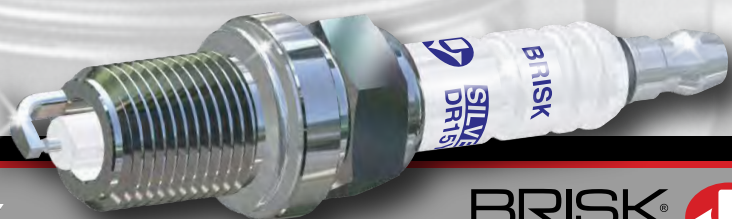

Silver

BRISK
USA ENTERPRISES, LLC



SPARK PLUG CROSS REFERENCE GUIDE

CHAMPION	BRISK
C6BYC C7YCC RC7BYC RC7YCC RC8PYP RC8YCC	DR14YS

CHAMPION	BRISK
C9YC C9YCC C10YCC RC8DMC RC87PYC RC89PYC RC9YC RC9YCC RC10YCC	DR15YS

CHAMPION	BRISK
C11YC C11YCC C12YC C12YCC RC10PYC RC12PYP RC12YC RC12YCC	DR17YS

RC7BYC4 RC7YCC4 RC8PYPB4	DR14YS-9
--------------------------------	-----------------

RC8VTYC4 RC9YC4 RC9YCC4	DR15YS-9
-------------------------------	-----------------

RC10PYP4 RC10VTYC4 RC11PYPB4 RC12YC4 RC12YCC4	DR17YS-9
---	-----------------

CHAMPION	BRISK
N279YC N7BYC N7GY N7YC N7YCC RN7YC RN7YCC	LR14YS

CHAMPION	BRISK
N281YC N8GY N9BYC N9YC RN9GY RN9YC RN9YCC	LR15YS

CHAMPION	BRISK
N11YC N12YC N14YC RN10VTYC RN11YC RN11YCC	LR17YS

N9BYC4 RN8VTYC4 RN9YCC4	LR15YS-9
-------------------------------	-----------------

RN10VTYC4 RN11YCC4	LR17YS-9
-----------------------	-----------------

CHAMPION	BRISK
L78C L82YC RL82YCC	NR14S

CHAMPION	BRISK
L82C L87YC L87YCC RL82CC RL87YC RL87YCC	NR15S

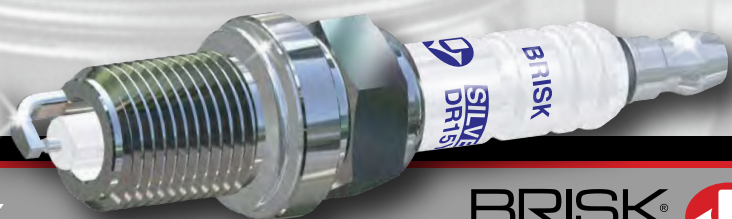

Silver

BRISK
USA ENTERPRISES, LLC



SPARK PLUG CROSS REFERENCE GUIDE

NGK	BRISK
BCP7E	DR14YS
BCP7ES	
BCP7ET	
BCPR7E	
BCPR7ES	
BCPR7ET	
BCPR7EY	
BKR7E	
BKR7E-N	
BKR7ES	
BKR7EY	
BKUR7ET	
PFR7B	
PFR7G	
PFR7G-9	
PFR7M	
PFR7N-D	
PFR7Q	
ZFR7F	

NGK	BRISK
BCP6ES	DR15YS
BCP6ET	
BCPR6ES	
BCPR6ET	
BKR6EK	
BKR6EKC	
BKR6EKE	
BKR6EKUB	
BKR6EP	
BKR6ES	
BKR6EY	
BKR6EYA	
BKUR6ET	
PFR6B	
ZFR6F	

NGK	BRISK
BCP5E	DR17YS
BCP5ES	
BCP5ET	
BCPR5E	
BCPR5ES	
BCPR5ET	
BK5E	
BK5ES	
BKR5E	
BKR5EK	
BKR5EKC	
BKR5EKU	
BKR5E-N	
BKR5EP	
BKR5ES	
BKR5EY	
BKR5EZ	
BKUR5ET	
PFR5B	
ZFR5F	

BCPR7ES-11	DR14YS-9
BCPR7EY-11	
PFR7B-11	
ZFR7F-11	
ZFR7J-11	

BCP6E-11	DR15YS-9
BCP6ES-11	
BCPR6E-11	
BCPR6ES-11	
BK6E-11	
BKR6E-11	
BKR6EKC-11	
BKR6E-N-11	
BKR6EP-11	
BKR6ES-11	
BKR6EY-11	
BKR6EYA-11	
BKR6N-11	
BKUR6ET-10	
PFR6B-11	
PFR6C-11	
ZF6A-11	
ZFR6A-11	
ZFR6F-11	
ZFR6J-11	

BCPR5ES-11	DR17YS-9
BKR5EKB-11	
BKR5EP-11	
BKR5ES-11	
BKR5EY-11	
BKR5N-11	
PFR5B-11	
PFR5C-11	
ZFR5A-11	
ZFR5F-11	
ZFR5J-11	

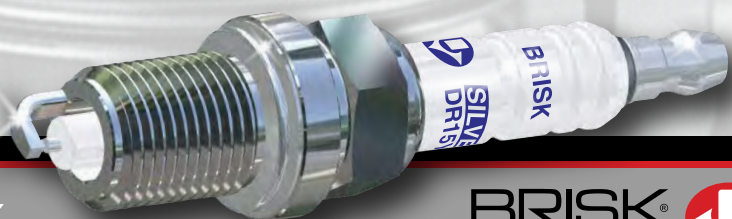

Silver

BRISK
USA ENTERPRISES, LLC



SPARK PLUG CROSS REFERENCE GUIDE

NGK	BRISK
BP7ES BP7ET BPR7E BPR7ES IGR7A PGR7A	LR14YS

NGK	BRISK
BP6E BP6ES BP6ESZ BP6ET BP6EY BPR6E BPR6EP-8 BPR6ES BPR6EY BUR6ET PGR6A	LR15YS

NGK	BRISK
BP5E BP5EA BP5EA-L BP5ES BP5ESZ BP5ET BPR5E BPR5EA BPR5EA-L BPR5ES BPR5EY	LR17YS

NGK	BRISK
ZGR6A	LR15YS

NGK	BRISK
BUR5ET PGR5A ZGR5A	LR17YS

NGK	BRISK
BPR6E-11 BPR6ES-11 BPR6EY-11 PGR6A-11 PGR6C-11	LR15YS-9

NGK	BRISK
BP5ET-10 BPR5E-11 BPR5EA-11 BPR5EP-11 BPR5ES-11 BUR5ET-10 BPR5EY-11 PGR5A-11 PGR5C-11	LR17YS-9

NGK	BRISK
B7HS B8HS BP7HS BPR7HS BR7HS BR8HS	NR14S

NGK	BRISK
B6HS BP6HS BP6HSA BPR6HS BR6HS	NR15S

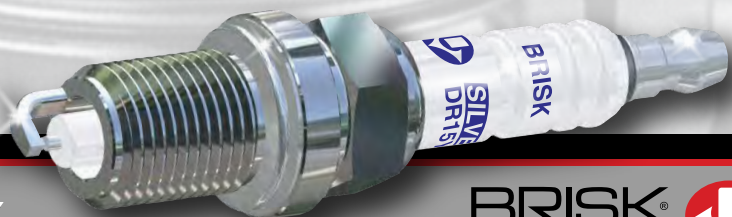

Silver

BRISK
USA ENTERPRISES, LLC



BRISK
USA ENTERPRISES, LLC



- More Power
- Faster Acceleration
- Durability

APPLICATION CHART

MANUFACTURER	COLDER			HOTTER		
BRISK	8	10	12	14	15	17
NGK	10	9	8	7	6	5
DENSO	31	27	24	22	20	16

For the 2008 - 2010 Ford 3 Valve engines with the new 12mm thread diameter plug we offer:

Brisk Silver Racing Spark Plug XCR14YS - stock and modified

Brisk Silver Racing Spark Plug XCR1EYS - heavy modified

↳ Brass Igniter Base

For the 2008 - 2009 Ford 4.0L, 5.0L, 5.4L 3 Valve engines with High Thread angle plug we offer:
Brisk Silver Racing and Performance Square Plug

Brisk Silver Racing Square Plug 3VR17YS - stock and light modified

Brisk Silver Racing Square Plug 3VR14S - light modified and modified

Brisk Silver Racing Square Plug 3VR18S - high boost and/or heavy rotate

Brisk Silver Racing Square Plug 3VR10S - jet-race water injection

Brisk Silver Race Plug 3VR10S - JTC performance Race Mustang 1000 RWHP (non boost and jet-race)

↳ all the Brisk performance and racing spark plugs are recommended type of use race with gasoline out-board ground electrodes

For the 4.0L, 5.0L, 5V and 4V, 5VT Mustang Coupe, Shelby Ford GT...

Brisk Silver Racing and Performance Square Plug

Brisk Silver Racing Spark Plug O14YS - jet to about 880 HP (non-resistor plug - do not use with Duffin conversion between coil/plug)

Brisk Silver Racing Spark Plug OR14S - jet to about 800 HP

Brisk Silver Racing Spark Plug OR12S - jet to about 880 HP

Brisk Silver Racing Square Plug O08S - jet to about 3,800 RWHP (non-resistor plug - do not use with Duffin conversion between coil/plug)

Brisk Silver Racing

Spark types:

O08S (non projected tip)

O10S (non projected tip, resistor)

O110S (non projected tip, resistor)

O10S (non projected tip)

OR12S (non projected tip, resistor)

OR14S (non projected tip, resistor)

O12YS (projected tip)

OR12YS (projected tip, resistor)

OR14YS (projected tip, resistor)

Replaces:

NGK B 5671A-10

NGK B 5671A-6

NGK B 5671A-8

NGK B 5671A-7

NGK G 5672A-0

