

gorilla

playsets

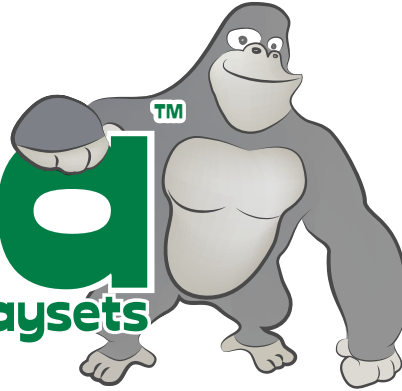

Treasure Trove II - Tarp Roof

Timber Shield Post Option
BOXES: 1500 (120" box),
1500 (108" box), CB

Model: 1500KT

(BOXES: 1501, 1502, 1504, 1505,
1509N, 1509T, 1515, 1517, Rad Ride
7 Tube Slide Box, 14' Scoop Slide
(bagged) & Slide Box)

Amber Post Option
BOXES: 1519, 1520,
1521, 1522

Copyright © 2016 Gorilla Playsets
All Rights Reserved



51-1034-T

190 Etowah Industrial Court
Canton, GA 30114
www.gorillaplaysets.com

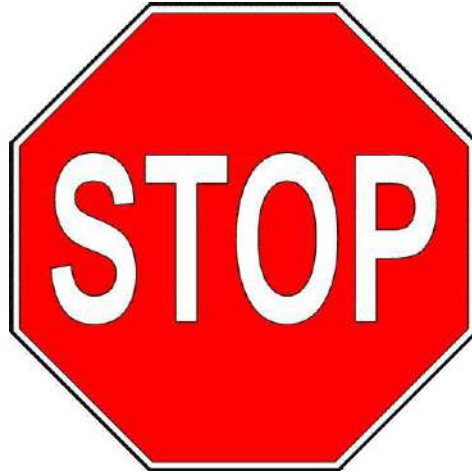

Please inspect and inventory all parts immediately upon accepting delivery. Use the inventory pages in the manual to make sure you have received all necessary parts. The quickest method to get any parts that are missing or damaged is to use our “Quick Response Center” located at:

www.gorillaplaysets.com/support

DO NOT RETURN THIS PRODUCT TO THE RETAILER OR CONTACT THE RETAILER DIRECTLY. THE RETAILER DOES NOT STOCK COMPONENTS.

PLEASE RETAIN ALL INSTRUCTIONS FOR FUTURE REFERENCE. KEEP THEM IN A SAFE PLACE WHERE YOU CAN REFER TO THEM AS NEEDED. CHECK FOR REVISED INSTRUCTIONS AT:

www.gorillaplaysets.com/manuals

GORILLA PLAYSETS WARRANTY – 2016

Gorilla Playsets® (“Gorilla”) warrants its play sets to be free from defects in workmanship and materials, under normal use and conditions, for 10 years for above ground structural wood components and for one year for all other components (e.g., swings, hardware, plastics, tarps, rope ladder, etc.).

Gorilla warrants all remaining products, including but not limited to its , Free Standing Swing Set, Free Standing Tire Swing, See-Saw, Children’s Picnic Table with Umbrella, Play-Zee-Bo™, Cedar Toy Chest and spring riders to be free from defects in workmanship and materials, under normal use and conditions, for a period of 1 year.

Cosmetic imperfections and natural tendencies of wood such as peeling, splintering, warping, seasonal checking or cracking, knots or knot holes, etc. are normal characteristics of all outdoor wooden play equipment and are not covered by this warranty. Checks or cracks in wood components that do not affect the intended function of the part, piece or overall swing set are not covered under this warranty.

Wood rot or decay that develops because the product was installed in an area with poor drainage is not covered under this warranty. Lumber that has been damaged by wood boring bees, or conditions that develop as a result of faulty or improper installation of the product, are not covered by this warranty. Fading of stain, discoloration or mold on any wood part or accessory is not covered by this warranty. Cracks in plastic components, surface rust on hardware and chips on powder coated materials are not considered defects in material as long as they do not affect the functionality or structural integrity of the part or component.

It is the owner’s responsibility to maintain the swing set. **This includes but is not limited to staining and sealing the lumber as needed and regular inspection to be sure all hardware is tight.** Instructions for proper maintenance can be found on Gorilla’s website. Imperfections or conditions that develop because of a failure to properly maintain the swing set are not covered by this warranty.

Gorilla will, at its discretion, replace any above ground part within the stated warranty period that is defective in workmanship or materials. This decision is subject to verification of the defect, which, at Gorilla’s discretion, may be accomplished by submitting photographs or by delivery of the defective part to Gorilla Playsets • 190 Etowah Industrial Ct. • Canton, GA 30114 • 1-800-882-0272 Monday to Friday 9AM-5PM EST. Any warranty claim must include proof of purchase, including the date of purchase. **In addition, within the first 30 days from the date of purchase, Gorilla will replace any parts discovered to be missing from or damaged in the original packaging.**

This warranty is valid only if the product is used for the purpose for which it was designed and installed at a residential, single-family dwelling. This warranty is void if the product is used in a commercial, institutional or multi-family setting. **This warranty does not cover normal wear and tear or (a) products that have been damaged by acts of God and/or nature, negligence, misuse or accident; (b) products that have been modified or repaired by unauthorized persons; (c) the cost of labor; or (d) the cost of shipping any replacement product or part.**

GORILLA DISCLAIMS ALL OTHER REPRESENTATIONS AND WARRANTIES OF ANY KIND, EXPRESSED, IMPLIED, STATUTORY OR OTHERWISE, INCLUDING THE IMPLIED WARRANTIES OF MERCHANTABILITY AND FITNESS FOR A PARTICULAR PURPOSE. GORILLA WILL NOT BE LIABLE FOR ANY INCIDENTAL OR CONSEQUENTIAL DAMAGES. This warranty is non-transferable and does not extend to the owners of the product subsequent to the original purchaser. Some states do not allow limitations on implied warranties or exclusion of incidental or consequential damages, so these restrictions may not be applicable to you. This warranty gives you specific legal rights. You may also have other rights which vary from state to state.

IMPORTANT SAFETY GUIDELINES

This product is recommended for use by children ages 3-11. This product is intended for residential use only and not intended for use in any public setting. A safety surface such as mulch or recycled tire should be used under the play set to prevent injury from falls. Also a 6 foot safety zone should be used around the entire play set.

As with any home project, good judgment and respect for power tools will greatly reduce the risk of injury. Gorilla recommends you follow all tool manufacturers' safety guidelines. Always wear eye protection and safety gloves to prevent injury. In several phases of construction two people may be required for lifting and securing of lumber. While the play set is being constructed, please keep children off the equipment until the project is complete. Bolts and screw heads should be checked regularly for tightness. The ground ladder, rope ladder, slide, swings and other areas where children spend a majority of their playtime should be checked more frequently.

Gorilla shall not be liable for incidental, indirect or consequential damages or injuries that result from building and/or playing on our play sets. Adult supervision is recommended anytime a play set is being used.

WEIGHT LIMITS FOR GORILLA PLAYSETS

- FORT PLATFORMS: 800 LBS. TOTAL WEIGHT
- SWING BELT: 225 LBS.
- TANDEM SWINGS: 70 LBS. PER CHILD. UP TO 140 LBS. TOTAL WEIGHT.
- TRAPEZE: 125 LBS.
- FULL BUCKET SWING/ HALF BUCKET SWING: 50 LBS.
- HEAVY DUTY TODDLER BUCKET SWING: 85 LBS.
- INFANT SWING: 35 LBS.
- TIRE SWING: 125 LBS. TOTAL WEIGHT
- ROPE LADDER: 75 LBS.
- ROCK WALL: 150 LBS.
- CLIMBING RAMP: 150 LBS.
- MONKEY BARS: 175 LBS.
- ALL SLIDES: 150 LBS.

Gorilla recommends that the weight limits for all components must not be exceeded. Failure to adhere to these and other safety guidelines could result in damage to the play set and injury to the users.

WARRANTY REGISTRATION

- TREASURE TROVE II- TARP ROOF -

Gorilla Playsets™ manufactures the finest quality products that are designed for outstanding strength and durability. We back our products with an unparalleled warranty. In the unlikely event that you will need to contact us about covered repairs, we must have a valid Warranty Registration on file.

3 EASY WAYS TO REGISTER	
OPTION 1	Fax this completed form to: (800) 880-3300 OR Mail this completed form to: Gorilla Playsets 190 Etowah Industrial Court Canton, GA 30114
OPTION 2	Complete the online registration form at: http://www.gorillaplaysets.com/register
OPTION 3	Scan this QR Code with your smartphone to complete the form using your phone: 

Where did you buy this product?

Date of Purchase
Store
Store City
Store State

Your registration information:

Name: _____ Email: _____

Address: _____

Street
City
State
Zip

Please select your age

18-30 41-50
 31-40 51+

How old are your children?

2-3 6-7
 4-5 8+

How would you rate the quality of this product?

★★★★★ Excellent
 ★★★★ Above Average
 ★★★ Average
 ★★ Below Average
 ★ Poor

Would you recommend this product to friends & family? Yes No

Comments: _____

THIS PAGE INTENTIONALLY LEFT BLANK

IMPORTANT – PLEASE READ

Congratulations! You have just purchase one of the finest residential wooden swing sets available today. As with any wooden product that spends its entire life outside, in varying elements, it is important to know what to expect with your new swing set so that your family can enjoy it for many years.

As your swing set acclimates to its new environment, natural characteristics of the wood can show in the form of checks, or “cracks” in the lumber. In almost all cases this is normal and it will not affect the structural integrity of your play set and is not covered under warranty.

KEEPING YOUR PLAYSET LIKE NEW

MUST DO's

The following owner responsibilities are crucial to the safety, integrity and aesthetic appeal of your swing set and may affect the warranty if not adhered to.

WITHIN 60 DAYS

- Check and tighten Hex Bolts/T-nuts, Carriage Bolts/Lock-nuts, and Lag Screws within the first 60 days and then twice annually – once before each season and then once during the season.

WITHIN 90 DAYS

- Apply a **sealant** or **semi-transparent stain with sealant** within the first 90 days of owning the swing set. Our own Stain/sealant is available online here: <http://www.gorillaplaysets.com/Playground-Sealant-p/10-0003.htm>

Oil based stain or water based stain may be used. Should you choose to use other stain we suggest asking the product covering specialists at any number of specialty paint stores or home improvement centers for a product that would work best for your local environment. ** TIP – while the set is new, take a small board from to the store with you so they can color match the tint of the stain or sealant.

SEASONAL REMINDERS

- If your area experiences regular snowfall, remove your fabric tarp/canopy to avoid stretching, sagging or tearing of the material. Store it inside, folded up, and it will be as good as new when winter is over.
- If your area experiences extremely cold temperatures, remove swing belts and other pliable features to prolong the lifespan of these play activities.

OTHER TIPS

- Spray swing hangers with Pam, Mazola or olive oil to stop squeaking; do not use petroleum based products such as WD-40 or motor oil.
- To repel yellow jackets and wasps, use a cotton ball and dab interior wooden corners underneath the play set deck with a liquid dish soap. Avoid using insecticides.
- To speed up the slide wipe the center of slide with wax paper every 2 - 3 weeks.

For additional safety and maintenance guidelines, please visit our website.



IMPORTANT DOCUMENTS

CUSTOMER MUST READ AND RETAIN

Please go to the following links and read important **SAFETY** information prior to using your new play structure.

<http://www.gorillaplaysets.com/Swing-Set-Safety-s/85.htm>

<https://www.gorillaplaysets.com/Maintenance-s/129.htm>

<http://www.gorillaplaysets.com/manuals.html> (Click on your specific model)

<http://www.gorillaplaysets.com/Warranty-s/82.htm>

NOTE: Your children's safety is our #1 concern. Observing the following statements and warnings reduces the likelihood of serious injury. Please review these safety rules regularly with your children.

WARNING:

Children must NOT use this play set until it has been completely assembled and inspected by an adult to ensure it has been properly installed.

Gorilla Playsets
190 Etowah Industrial Court
Canton, GA. 30114



Timber Shield Post Option
BOXES: 1500 (120" box),
1500 (108" box), CB

Model: 1500KT
(BOXES: 1501, 1502, 1504, 1505,
1509N, 1509T , 1515, 1517, Rad Ride
7 Tube Slide Box, 14' Scoop Slide
(bagged) & Slide Box)

REV: 6.6.2016

Amber Post Option
BOXES: 1519, 1520,
1521, 1522

TABLE OF CONTENTS

Safety Guidelines.....	Pages 4-7
Leveling Fort, General Information and Definitions.....	Pages 7-9
How to Install T-nuts, Board Identification, Predrill Lag Screw Directions and Swing Beam Loading.....	Pages 10-14
Site Plan, Required Tool List and Kit Contents.....	Pages 15-16
Hardware, Lumber and Accessory Checklists.....	Pages 17-45
Adding T-Nuts to Lower Level Corner Posts.....	Step 1
Framing Lower Level Fort.....	Steps 2-12
Mounting Deck.....	Step 13
Rock Wall Assembly/Installation.....	Steps 14-18
Ladder Assembly/Installation.....	Steps 19-20
Adding T-Nuts to Upper Level Corner Posts.....	Step 21
Framing Upper Level Deck.....	Steps 22-31
Mounting Upper Level Deck.....	Steps 32-37
Assembling and attaching Rad Ride Tube Slide.....	Step 38
Rear Bottom Panel Board, Rear Center Post.....	Steps 39-40
Upper Level Panel Slats.....	Step 41
Lower Level Front Center Post.....	Step 42
Upper Level Steps.....	Step 43
Lower Level Panel Slats.....	Step 44
Swing Beam Assembly.....	Steps 45-52
Tarp Roof Assemblies.....	Steps 53-55
Safety Boards.....	Step 56
Picnic Table Assembly and Installation.....	Steps 57-59
Sandbox Seats/Name Plate.....	Step 60
Tic Tac Toe Assembly/Installation.....	Steps 61-62

TABLE OF CONTENTS

Rope Ladder.....	Step 63
Rock Wall Rope.....	Step 64
Safety Handles (Lower Level) and Safety Handles (Upper Level).....	Steps 65-66
Flag Kit.....	Step 67
Telescope.....	Step 68
Steering Wheel.....	Step 69
Hanging the Swings.....	Step 70
Ground Stakes.....	Step 71
Super Scoop Slide.....	Step 72
<u>Part II Clatter Bridge and Tower</u>	
Attaching T-Nuts to the Corner Posts.....	Step 1
Framing the Tower.....	Steps 2-7
Deck Spacers, Front Face Board and Deck Boards.....	Steps 8-10
Rear Bottom Panel Board.....	Step 11
Panel Slats.....	Step 12
Bridge Rails and Slats.....	Steps 13-15
Bridge Deck Assembly and Installation.....	Steps 16-20
Tarp Roof Assembly.....	Steps 21-23
Wave Slide Installation.....	Step 24
Leftover Parts List.....	Page 143
<u>Appendix:</u>	
Clatter bridge mesh Instructions, etcetera.....	Page 144

**PLEASE READ OWNER'S MANUAL CAREFULLY
BEFORE STARTING ASSEMBLY!**

Safety and Maintenance Tips for Your New Play Set:

NOTE: Your children's safety is our #1 concern. Observing the following statements and warnings reduces the likelihood of serious or fatal injury. Please review these safety rules regularly with your children.

- This play set is designed for the use of 4 occupants who have a combined weight not exceeding 800 pounds on the elevated floor, 3 occupants who have a combined weight of 425 pounds on the swing area, for a total Unit capacity of 7 occupants who have a combined weight of 1225. (This weight does not include any picnic table area(s).)
- On-site adult supervision is required.
- Teach children not to walk close to, in front of, behind, or between moving swings or other moving playground equipment.
- Teach children to sit in and never stand on swings
- Teach children not to twist the chains and ropes and not to loop them over the swing beam, since this may reduce the strength of the chain or rope.
- Teach children not to jump from swings or other playground equipment in motion.
- Teach children not to push empty seats. The seat may hit them and cause serious injury.
- Teach children to sit in the center of the swings with their full weight on the seats.
- Teach children not to use the equipment in a manner other than intended.
- Teach children to always go down slides feet first. Never slide headfirst.
- Teach children to look before they slide to make sure no one is at the bottom.
- Teach children to never run up a slide, as this increases their chances of falling.
- The parents should have the children dress appropriately with well-fitting shoes. Loose clothing such as scarves and ponchos should not be worn. Always take off, tie up or tuck in cords and drawstrings on children's clothing. These things can get caught on playground equipment and strangle a child.
- Teach children not to climb when the equipment is wet.
- Teach children to never jump from a fort deck. They should always use the ladder, ramp or slide.
- Teach children to never crawl or walk across the top of monkey bars or swing beam.
- Teach children to never crawl on top of a fort roof or on the outside of a tube slide.
- Verify that any suspended climbing ropes, chains, or cables are secured at both ends and that they cannot be looped around an adult hand.
- Teach children not to attach items to the playground equipment that are not specifically designed for use with the equipment, such as, but not limited to, jump ropes, clothesline, pet leashes, cables and chain as they may cause a strangulation hazard.
- Teach children to never wrap their legs around swing chain.
- Teach children to never slide down the swing chain.
- Teach children to remove their bike or other sports helmet before playing on the playground equipment.
- Teach children to NEVER look at the sun or other bright light through any accessory such as but not limited to a telescope, periscope or binoculars.

WARNING: Children must NOT use this play set until it has been completely assembled and inspected by an adult to insure it has been properly installed and the swing beam legs are anchored.

Safety and Maintenance Tips for Your New Play Set: (continued)

Playgrounds should be inspected on a regular basis. If any of the following conditions are noted, they should be removed, corrected, or repaired immediately to prevent injuries.

- Hardware that is loose, worn or that has protrusions or projections.
- Exposed equipment footings.
- Scattered debris, litter, rocks, or tree roots.
- Splinters, large cracks, and decayed wood components.
- Deterioration and corrosion on structural components, which connect to the ground.
- Missing or damaged equipment components, such as handholds, guardrails, swing seats.
- Check all nuts and bolts twice monthly during the usage season and tighten as required. (But not so tight that you crack the wood) We recommend you check the swing beam and hardware often due to wood expansion and contraction. It is particularly important that this procedure be followed at the beginning of each season.
- Remove plastic swing seats and take indoors or do not use when the temperature drops below 32°F. Reinstall swings and other swing equipment at the beginning of the usage season.
- Oil all metallic moving parts monthly during the usage period.
- Check all coverings for bolts and sharp edges twice monthly during usage season to be certain they are in place. Replace when necessary. It is especially important to do this at the beginning of each new season.
- Check swing seats, ropes, cables and chains monthly during usage season for evidence of deterioration. Replacement should be made of any swing seat that has developed cracks in the plastic seats. Ropes, cables and chains should be removed and replaced if excessive wear is found. Contact us for warranted replacement parts.
- Swing chains, rings, ropes, etcetera should always be fastened to a rotating swing hanger. NEVER attach a chain, ring, rope, etcetera to a stationary hanger such as but not limited to an eye bolt. Severe wear could occur leading to an injury.
- For rusted areas on metallic members such as monkey bars, hand supports brackets, etc.; sand and repaint, using a non lead-based paint meeting the requirements of Title 16 C.F.R. Part 1303. These requirements are available at: <http://www.cpsc.gov/>
- Inspect wood parts monthly. The grain of the wood sometimes will lift in the dry season causing splinters to appear. Light sanding may be necessary to maintain a safe playing environment. If you are treating your play set with stain regularly, it will help prevent severe checking/splitting and other weather damage.
- Once or twice a year, depending on your climate conditions, you must apply some type of protection (sealant) to the wood of your unit. Prior to the application of sealant, lightly sand any “rough” spots on your set. Please note this is a requirement of your warranty.
- Creating and maintaining the play set on a level location is very important. As your children play, your play set will slowly dig its way into the soil, and it is very important that it settles evenly. Make sure the play set is level and true once each year or at the beginning of each play season.
- Twice a month during the usage season rake the playground protective surfacing materials to prevent compaction and maintain appropriate depths. Replace the protective surfacing materials as required.
- Disposal Instructions: When the play set is no longer desired, it should be disassembled and disposed of in such away that no unreasonable hazards will exist at the time the play set is discarded.

Play Set Surfacing Recommendations:

Below are some of the recommendations that the U.S. Consumer Product Safety Commission (CPSC) offers from its Handbook for Public Playground Safety. The guide can be downloaded in full at www.cpsc.gov/cpscpub/pubs/325.pdf

1. Protective Surfacing - Since almost 60% of all injuries are caused by falls to the ground, protective surfacing under and around all playground equipment is the most critical safety factor on playgrounds.

Certain manufactured synthetic surfaces also are acceptable; however, test data on shock absorbing performance should be requested from the manufacturer.

Asphalt and concrete are unacceptable. They do not have any shock absorbing properties. Similarly, grass and turf should not be used. Their ability to absorb shock during a fall can be reduced considerably through wear and environmental conditions.

Certain loose-fill surfacing materials are acceptable. Surfacing materials are acceptable, such as the types and depths shown in the table.

Fall Heights and Materials

Type Of Material	6 in. depth	9 in. depth	12 in. depth
Double-Shredded bark mulch	6' Fall Height	10' Fall Height	11' Fall Height
Wood Chips	6' Fall Height	7' Fall Height	12' Fall Height
Fine Sand	5' Fall Height	5' Fall Height	9' Fall Height
Shredded Tires*	10-12' Fall Height	N/A	N/A
Fine Gravel	6' Fall Height	7' Fall Height	10' Fall Height

*This data is from tests conducted by independent testing laboratories on a 6-inch depth of uncompressed shredded tire samples produced by four manufacturers. The tests reported critical heights, which varied from 10 feet to greater than 12 feet. It is recommended that persons seeking to install shredded tires as a protective surface request test data from the supplier showing the critical height of the material when it was tested in accordance with ASTM F1292.

It should be recognized that all injuries due to falls cannot be prevented no matter what surfacing material is used.

2. Fall Zones - A fall zone, covered with a protective surfacing material, is essential under and around equipment where a child might fall. This area should be free of other equipment and obstacles onto which a child might fall. Stationary climbing equipment and slides should have a fall zone extending a Minimum of 6' in all directions from the perimeter of the equipment.

Swings should have a fall zone extending a minimum of 6' from the outer edge of the support structure on each side. The fall zone in front and back of the swing should extend out a minimum distance of twice the height of the swing as measured from the ground to the top of the swing support structure.

LEVELING YOUR FORT DURING ASSEMBLY

- Complete the steps which will be the basic frame of the fort. {i.e. four corner posts with base (sand box boards) and deck supports}
- Position in the most level area chosen for the play set, keeping in mind the location and size of the swing beam, ladder, slides, etc. that extend off the fort.
- Once the frame is in the final position, check for vertical and horizontal levelness to determine which side(s) will need to be dug into the ground to level the play set.
- With a shovel, score the ground around the outside edges of the sandbox boards on the 'high' side of the fort. This is the area that will be dug in. Make sure to score deep enough; the scored lines will be your digging template.
- Push the frame off and away from the scored area, far enough to dig and remove dirt to reach the appropriate depth.
- Dig a channel along the scored line(s) for the base of the fort (corner post and sandbox boards) to rest into. Dig the channel(s) to the same level depth. The bottom of the channel(s) should be level to each other so your frame doesn't teeter or rock because the channel(s) are uneven.
- Once you have removed enough grass and dirt, slide/push the frame into the channel(s). Place a level on the vertical and horizontal boards of the frame to determine if enough soil, or too much, was removed.
- Repeat this process until the basic frame is plumb and level and in its final position before completing the rest of the assembly.
- Measure to make sure fort is square.

Important: if you require a channel depth of more than 6", then we recommend you have your play set area professionally graded before completing assembly.

Example Play area:

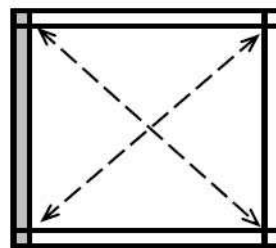
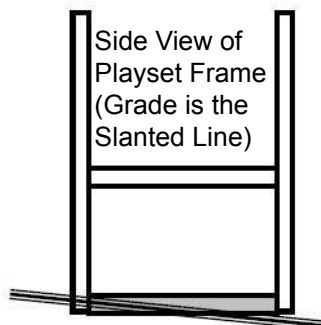

■ = Area to be scored and channeled for levelness

General Info to Review Before Installation

- Depending on your experience, assembly of the playset can take as little as 6 hours up to 24 hours, depending on size, after inventory of parts; therefore, we recommend you set aside a full two days for assembly.
- Identify all of the parts for your play set. Empty each box and lay out boards so you can see each part. Your instruction book will have detailed drawings that will make it easy for you to recognize individual parts. Keep all hardware and metal parts separate from wooden pieces.
- After everything is laid out, check carefully to ensure all parts are present. Make sure there are no broken boards.
- Find an area to sort your hardware. It is best to open the hardware on a solid surface so that you do not lose any pieces in the grass. This will save time and familiarize you with all the different pieces in the hardware bag.
- Important note: Wood has some natural defects such as knots, surface cracks, etc... We reject parts that are structurally defective. We use a high quality lumber in our structures; however, you should inspect each part for splinters or rough spots and sand them smooth to prevent injury.
- After familiarizing yourself with all of the components, read all instructions thoroughly. Reading instructions after you have studied the parts will help you understand the installation process, and help to eliminate unnecessary mistakes.
- Pay close attention to the diameter and length of each bolt and screw.
- Never tighten hardware completely at first. It helps to have some adjustment for bolt alignment while you are attaching parts together. After everything is square, tighten each joint.
- After the main unit is assembled it is critical that the floor is level and square. If the main frame is not level, the walls and floor will be out of square.
- After you complete installation, make sure every bolt, screw, and nut is tight, and every board is secure. Wood will expand and contract with the seasons.
- Place the set on level ground, not less than 6 feet from any structure or obstruction such as a fence, garage, house, overhanging branches, laundry lines, or electrical wires.

This page is a list of definitions and explanations used throughout our instructions to aid you in the assembly of your play set.

Offset Holes- Throughout the installation procedures we will refer to parts with offset holes. This refers to the orientation of the holes on the board. An offset hole is one that is closer to one side than it is the other or in other words, it is not centered on the board. In the procedures you will be instructed to attach the boards with the holes offset up or with the holes offset down. This refers to which side of the board the hole/holes should be closer to. Offset holes up= hole/holes will be closer to the top of the board. Offset holes down= hole/holes will be closer to the bottom of the board. Note: some parts do not have offset holes, but instead the holes are on center. Therefore there will not be any reference on how to offset these parts.

EXAMPLE OF OFFSET HOLES UP

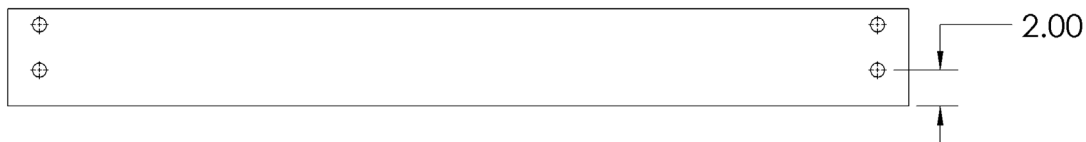

EXAMPLE OF OFFSET HOLES DOWN

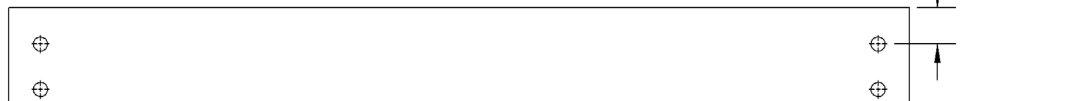

Counter-sunk holes - Many of the parts that will be used have counter-sunk holes. A counter-sunk hole is one that surrounds one side of a through hole, but does not extend through the wood it's self. When using a counter-sunk hole the bolt will be inserted through the through hole and either the head of the bolt and washer or nut and washer will occupy the counter sunk hole.

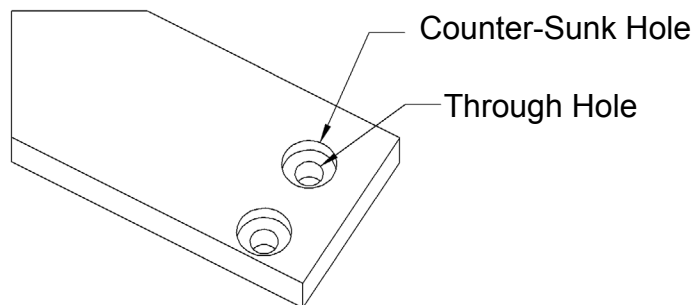

Lag Screws- Lag screws are used in the construction of our play sets to enhance the structural integrity of the unit. There will not be predrilled holes in the post for lag screw installation. Lag screws are self-tapping, though if you are using a manual socket wrench it may be advantageous to pre-drill a hole first. Instructions for this are provided on a separate page in the front of the manual. Be sure to tighten the lags completely when driving them in by hand. Power tools such as a heavy duty impact driver or large power drill should have enough torque to drive in the lag screws, but make sure not to over tighten as this can cause the threads to “strip out” in the post.

Common Installation Practice Installing T-nuts

When installing T-nuts into the wood, use a smooth faced hammer to set the face of the T-nut flush into the wood.

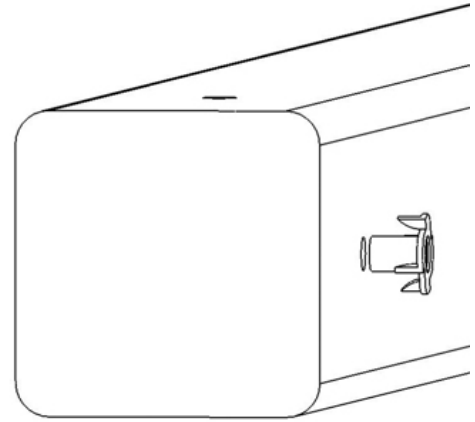
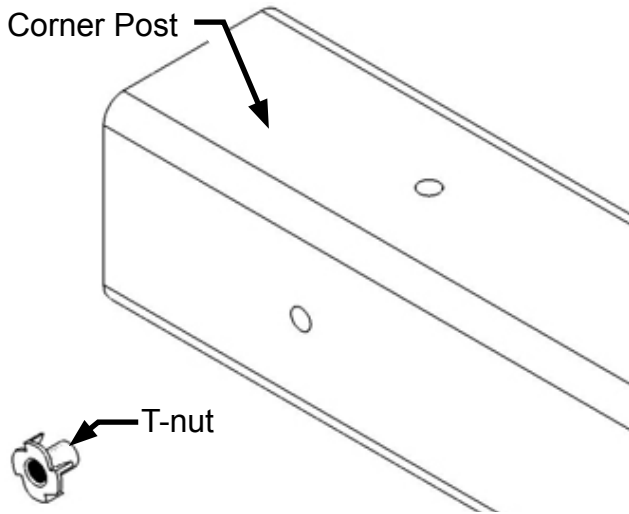

Insert the barrel of the T-nut into the predrilled hole. Using a smooth faced hammer, drive the T-nut until the face of the T-nut is flush to the wood.

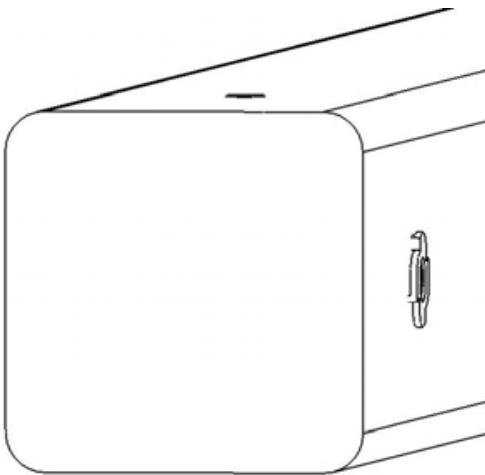

This picture shows the T-nut inserted and installed flush to the wood.

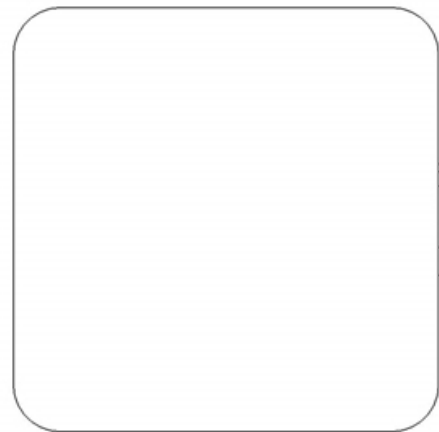

This picture shows an end view of the T-nut installed flush to the wood.

WARNING: DO NOT EMBED THE TOP OF THE T-NUT INTO THE FACE OF THE WOOD

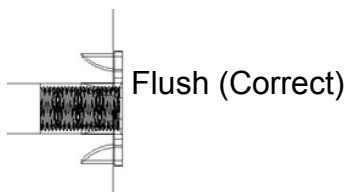

Cross Section end view, you are looking at an X-ray view of the post and T-nut. The barrel of the T-nut is in the corner post the line is the face of the wood.

HOW A T-NUT WORKS

THE FIRST STEP IN OUR ASSEMBLY INSTRUCTIONS IS TO INSERT T-NUTS INTO THE CORNER POSTS. A T-NUT IS A FASTENER WHICH IS THREADED ON THE INSIDE AND IT FUNCTIONS JUST LIKE A STANDARD HEX NUT. YOU INSERT THE T-NUTS INTO THE PREDRILLED HOLES IN THE CORNER POSTS.

THE T-NUT HAS A BARREL SHAPED END WHICH GOES INTO THE HOLE IN THE CORNER POST. THE T-NUT ALSO HAS AN FLANGE SHAPED END WITH TEETH. THE TEETH PENETRATE INTO THE CORNER POST WOOD TO PREVENT THE T-NUT FROM SPINNING WHEN YOU TIGHTEN THE HEX HEAD BOLT.

SHOWN BELOW YOU WILL SEE THE T-NUT IS HAMMERED INTO THE CORNER POST ON THE BACK SIDE. THE BOARD IS BEING ATTACHED ON THE FRONT SIDE OF THE CORNER POST.

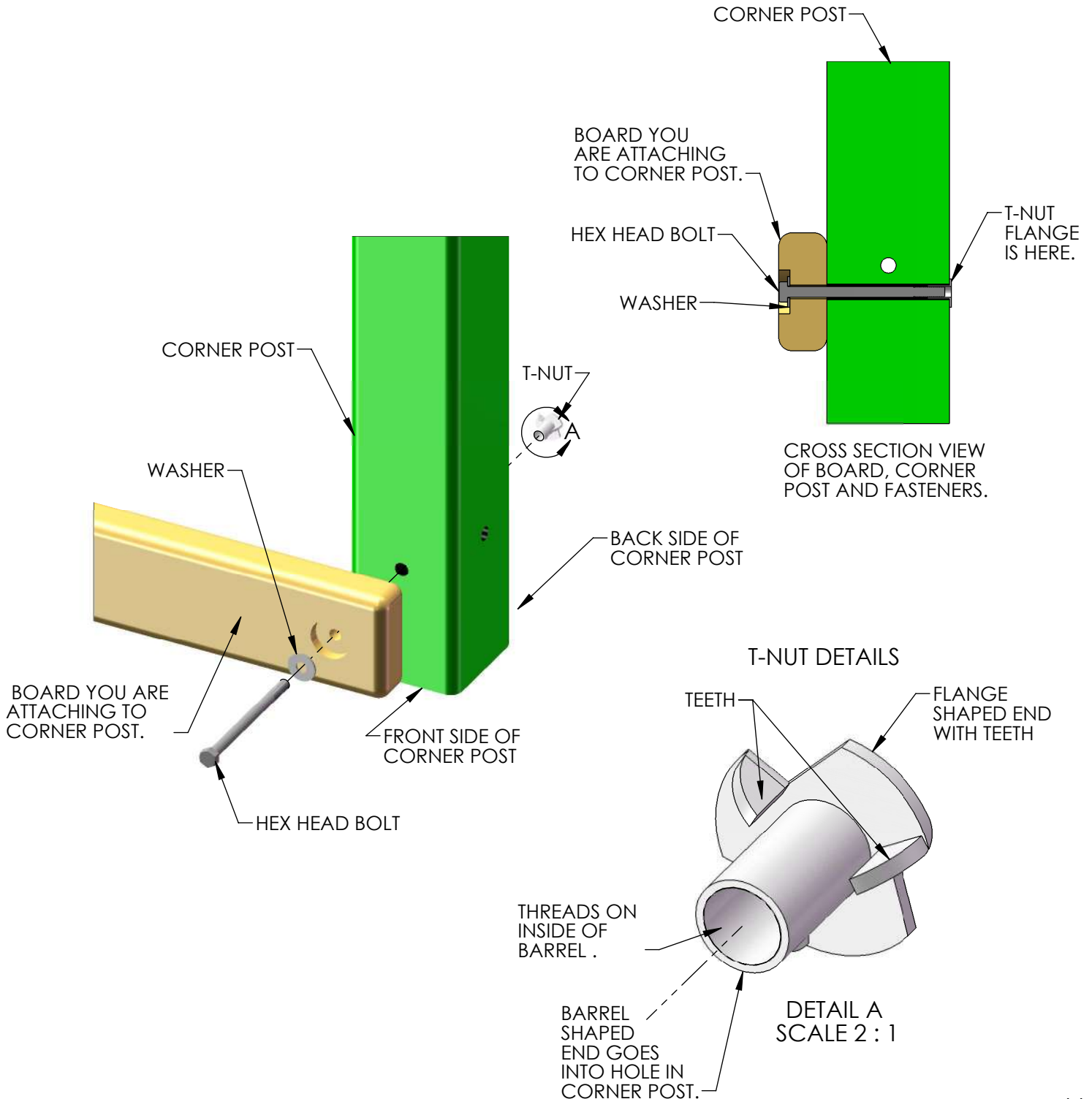

BOARD IDENTIFICATION

1. On the end of each board there should be a small white tag that is stapled or stuck into place. Remove the staples and/or tag after the board is installed.
2. This white identification tag displays the thickness, width, length and an abbreviated description of the part.

Example: a tag reads "2-4-3600-BPB"

- The 2 is the thickness of the board. "Nominal Lumber" at a home center will measure 1-1/2" for the thickness. We "remill" that lumber to 1-3/8" thick.
- The 4 is the width of the board. "Nominal Lumber" at a home center will measure 3-1/2" for the width. We "remill" that lumber to 3-3/8" wide.
Note: sometimes the width will be smaller than 3-3/8" because:
A) We need the width of the part to fit into a certain area of the play set.
B) We need the designation to be simple.
- The 3600 is the length of the board. It means the board is 36 inches long. If the code were 3625 then the board is 36-1/4" in length.
- The "BPB" abbreviation stands for "Bottom Panel Board". The wood part bill of materials in the instructions has a description which will match the abbreviation closely.
- In the event that there is no tag on a wood part measure the part then:
A) Use the measurements and compare them to the wood list at the front of the instructions to identify it.
B) Look at the holes on the wood part and compare them to the pictures in the wood list.
C) Look to see if the holes are centered or if they are offset up or offset down.
This should help you identify any parts that have missing tags. In the event that you cannot identify a board please email us for assistance.

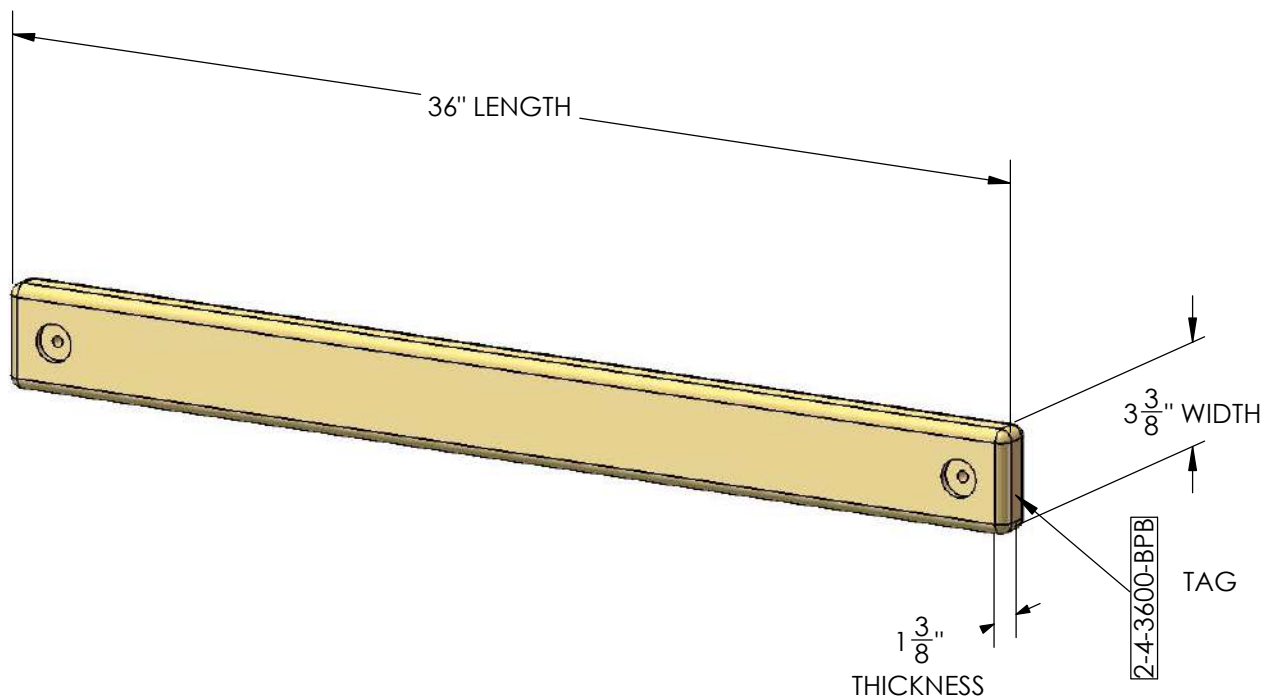

PRE-DRILL LAG SCREW DIRECTIONS

Pre-drilling holes for lag screws will make it easier to drive the screws in by hand. "Jobber" length drill bits are available in sizes that are longer than standard drill bits and those are ideal for the job. When using the drill bit you will have to "spot" drill the post and then remove the board you are attaching to finish drilling the hole.

Pay attention to the *DIAMETER* of the lag screw you are installing. Your playset may come with two different diameter lag screws. Each diameter will require a different size drill bit. When installing lag screws **DO NOT OVERTIGHTEN.**

LAG SCREW DIAMETER	DRILL BIT SIZE
5/16" DIAMETER	9/64"
3/8" DIAMETER	11/64"

Example: 3/8" diameter x 3-1/2" lag screw

This would be like the 2 x 4 board installation shown below. Place the board into position. Spot Drill through the holes in the 2 x 4 board into the corner posts with an 11/64" drill bit. Remove the 2 x 4 board. Continue to drill the holes to a total depth of 2-5/16" as shown at the right. Install the 2 x 4 board.

Example 5/16" diameter x 3-1/2" lag screw

This would be like the 2 x 4 board installation shown below. Place the board into position. Spot Drill through the holes in the 2 x 4 board into the corner posts with an 9/64" drill bit. Remove the 2 x 4 board. Continue to drill the holes to a total depth of 2-5/16" as shown at the right. Install the 2 x 4 board.

Example 3/8" diameter x 5" lag screw

This would be like the 4 x 4 board installation shown below. Place the board into position. Spot drill through the holes in the 4 x 4 board into the corner posts with an 11/64" drill bit. Remove the 4 x 4 board. Continue to drill the holes to a total depth of 2-13/16" as shown at the right. Install the 4 x 4 board.

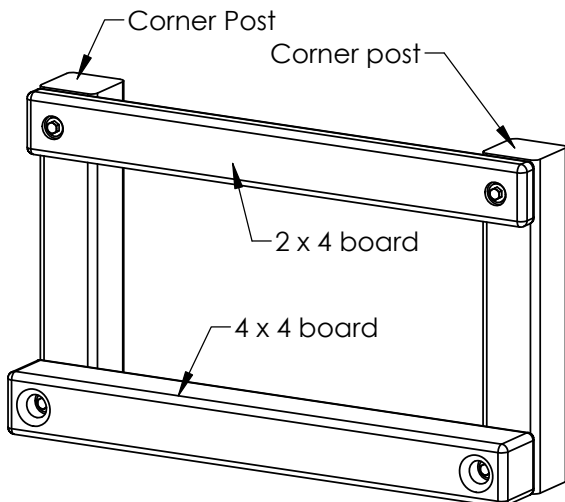
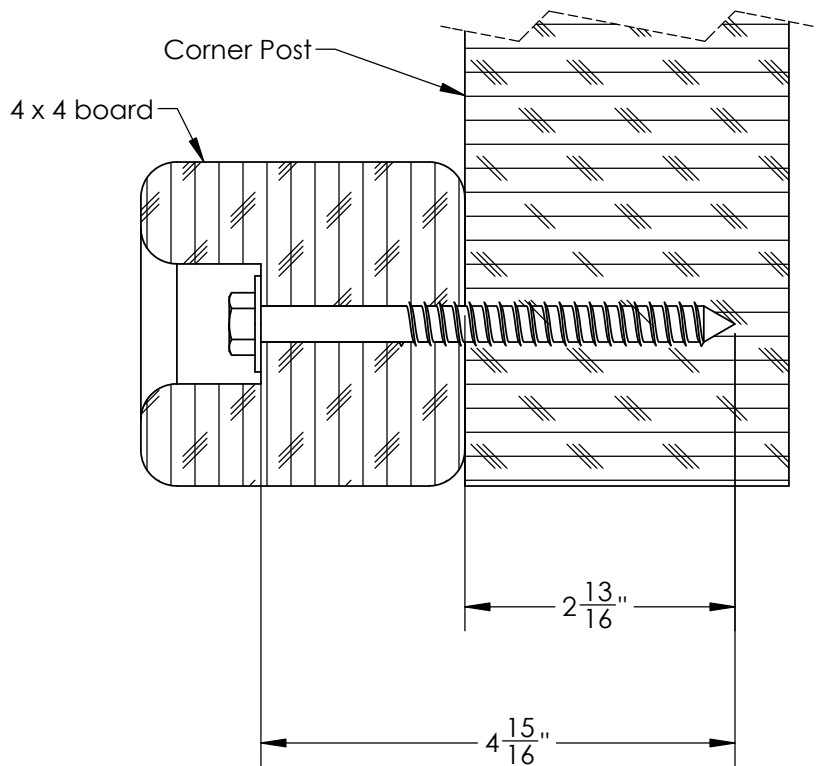
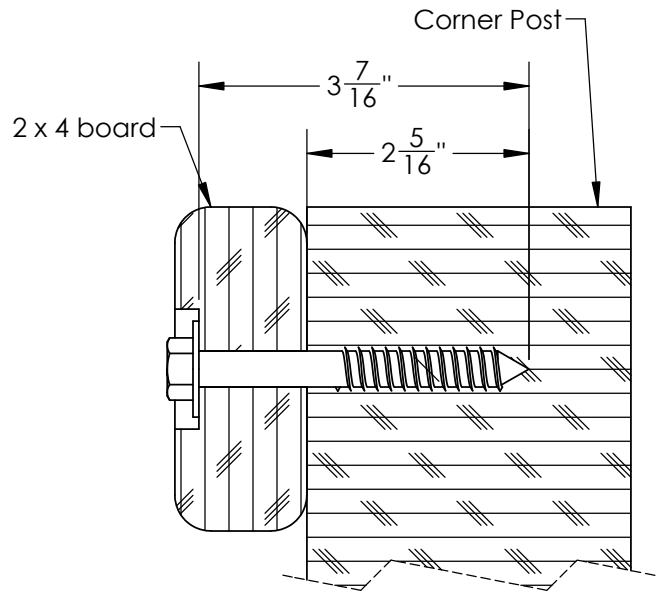

SWING BEAM LOADING

Weight Limits for Accessories:

The weight limit for a Swing Belt is 225 lbs. (Although 150lbs is the maximum recommended swinging weight capacity for the swing position.)

The weight limit for a Trapeze Bar is 125 lbs.

Maximum Allowable swinging weight for a three position swing:

- 1) The maximum allowable swinging weight at each Swing Belt position is 150 lbs.
- 2) The maximum allowable swinging weight at the Trapeze position is 125 lbs.
- 3) The MAXIMUM SWING BEAM LOAD IS 425 lbs.

MAXIMUM SWING BEAM LOAD IS 425 LBS.

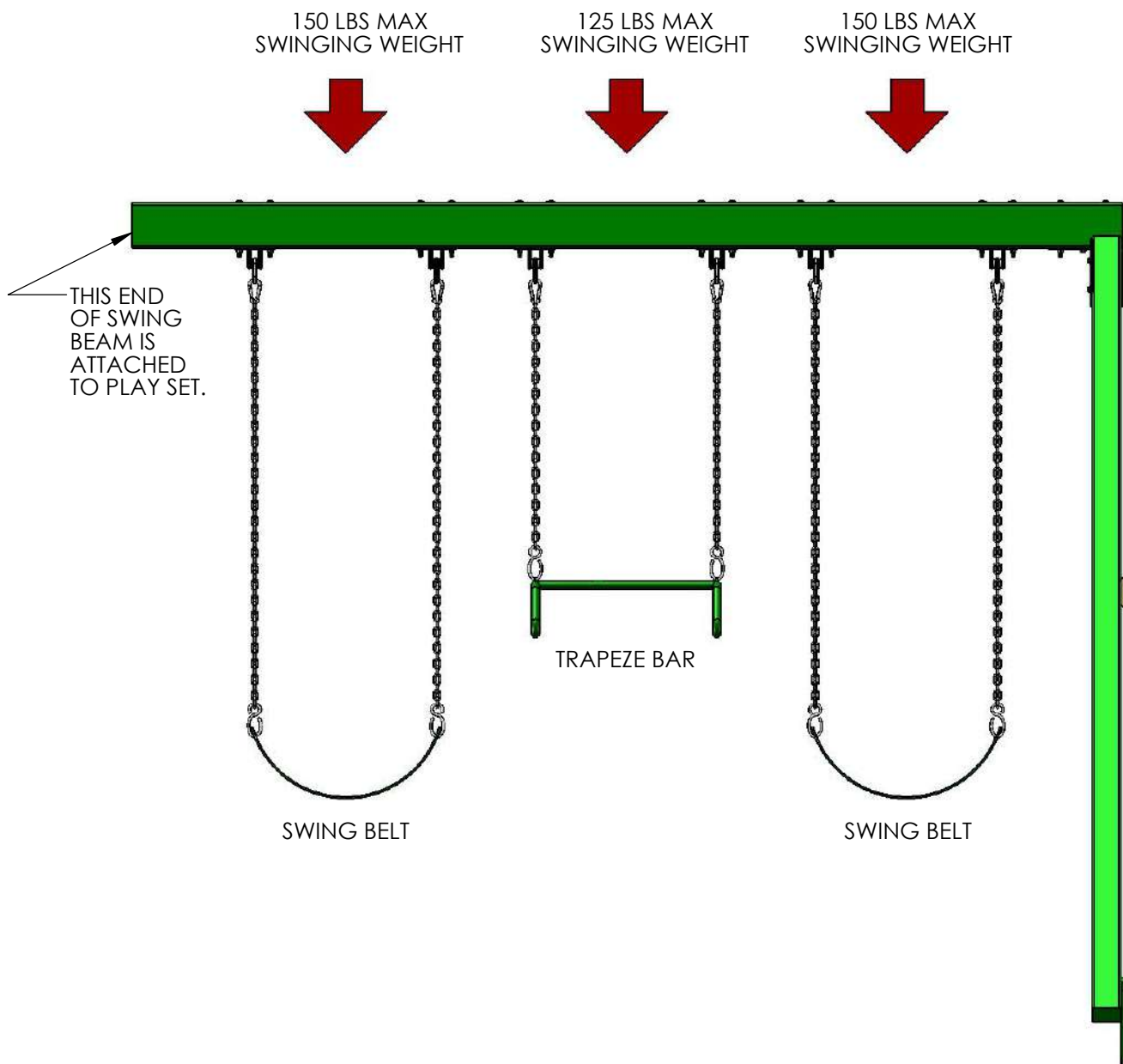

Please familiarize yourself with the manual, parts/components and general construction process of your new playset before getting started.

SITE PLAN:

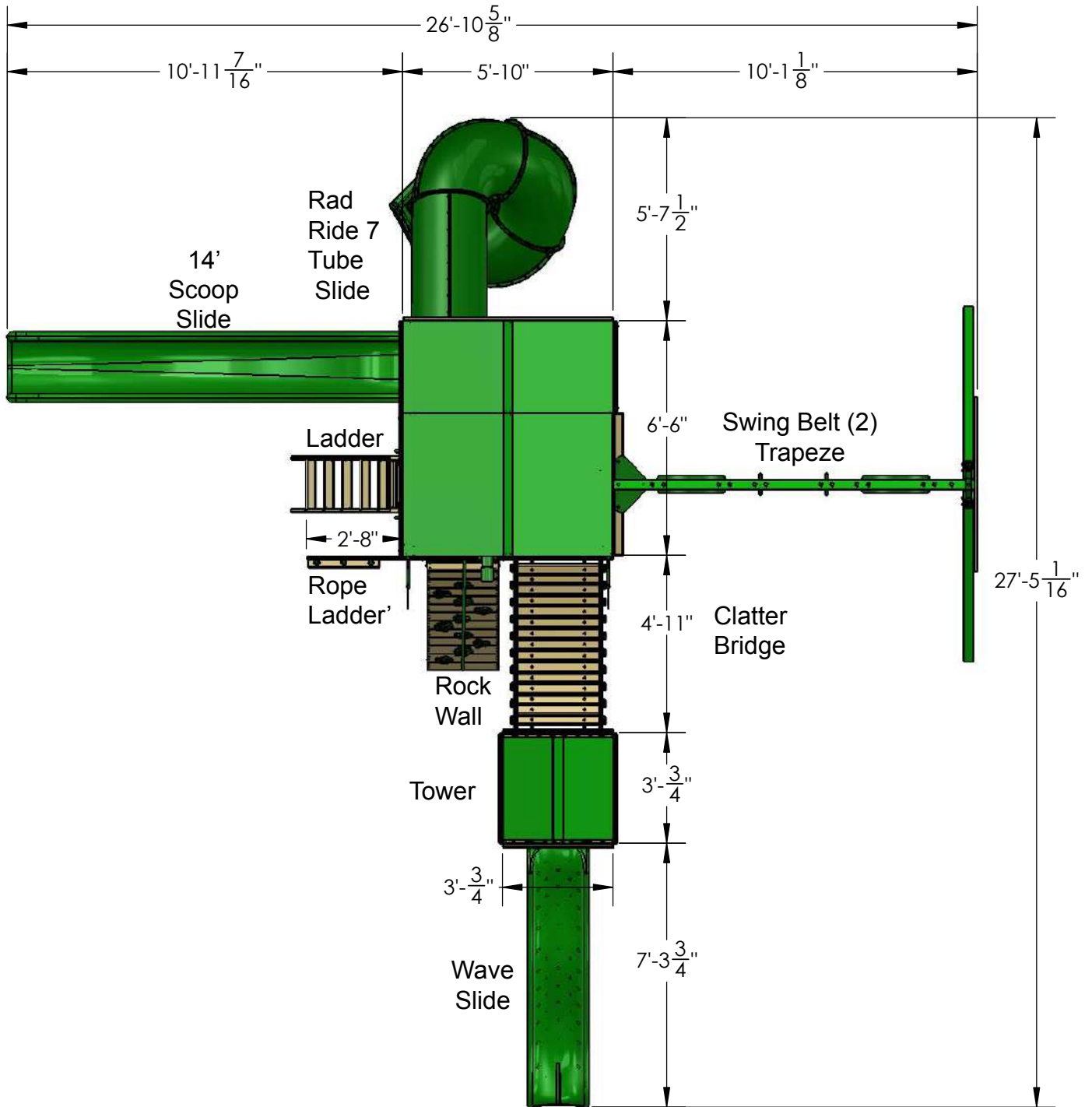

Playset height: 13 feet - 1-5/8 inches

Deck heights: 5 feet and 7 feet

Swing Beam height: 7 feet - 7-1/2 inches

Approximate assembly time: 16-18 hours

(6) foot unobstructed safety perimeter around playset recommended

REQUIRED TOOL LIST:

- Standard or Cordless Drill w/ Phillips Bit (#2 square bit provided)
- Drill Bits 1/8", 3/16", 3/8", 9/64", 11/64", 1" Paddle Bit
- 1/2" Wrench and Socket
- 1/2" Deep Well Socket
- 9/16" Deep Well Socket
- 9/16" Wrench and Socket
- Level
- Carpenters Square
- Tape Measure
- Extension Cord (if using standard drill)
- Hammer
- Pencil
- Locking Pliers (Vise Grips)
- Shovel
- Marker or Tape (See Step 63)
- Clear Silicone

KIT CONTENTS

Swings, Slides, Accessories:

- (Qty) Description
- (2) Swingbelt w/ Chains
- (1) Trapeze Bar w/ Chains
- (1) Wave Slide
- (1) 14' Scoop Slide
- (1) Rad Ride Tube Slide
- (10) Rock Wall Grips (assorted colors)
- (1) Telescope
- (2) Flag Kit
- (1) Tic Tac Toe
- (1) Steering Wheel
- (6) Safety Handle
- (1) Tarp (Lower Level) 47-3/8" x 105"
- (1) Tarp (Upper Level) 30-1/4" x 105"
- (1) Clatter Bridge Tarp 34-1/4" x 57-1/2"
- (2) Ground Stake
- (2) 96" Chain Sections
- (1) Clatterbridge Mesh (pair)

Fort Hardware:

see following pages

Swing Beam Hardware:

see following pages

Wood Components:

see following pages



#14 X 1-1/4"
 PAN HEAD SCREW
 QTY: 4

#8 X 1"
 WOOD SCREW
 QTY: 2



#8 X 1-3/4"
 WOOD SCREW
 QTY: 4



#8 X 2"
 WOOD SCREW
 QTY: 189



#8 X 2-1/2"
 WOOD SCREW
 QTY: 52



#8 X 3"
 WOOD SCREW
 QTY: 20

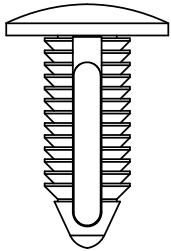

3/8" ϕ X 1-1/8"
 BLACK PLASTIC
 PLUG
 QTY: 6

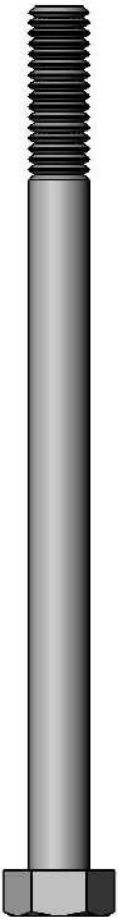

5/16 X 4-1/2"
 HEX BOLT
 QTY: 14



5/16" TEE NUT
 QTY: 22

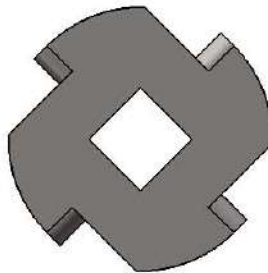

TORQUE WASHER
 QTY: 17

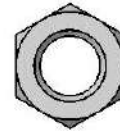

3/8" LOCK NUT
 QTY: 19

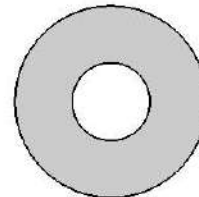

3/8" WASHER
 QTY: 31



5/16 X 1-1/2"
 HEX BOLT
 QTY: 8

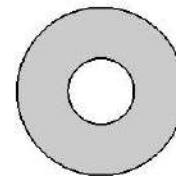

5/16" WASHER
 QTY: 34

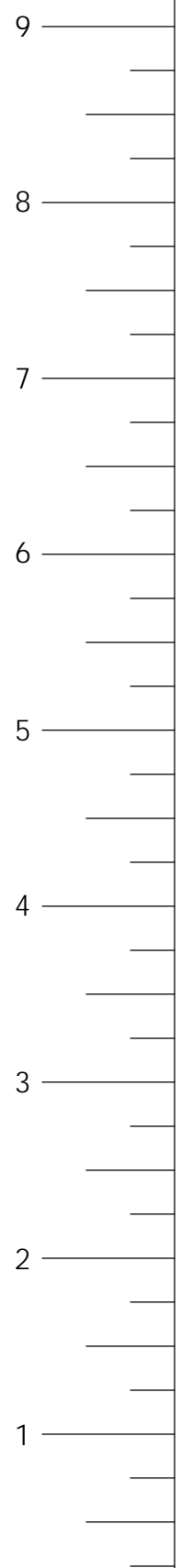

USE THE RULER TO THE RIGHT TO MEASURE YOUR BOLTS AND SCREWS. PICTURE VIEWS SHOWN ABOVE ARE 1:1 SCALE AND CAN BE USED TO MATCH BOLT AND SCREW SIZES.

1501 HARDWARE
 PAGE: 2 OF 2
 REV A: 9/10/2014 JH

5/16" X 3-1/2"
 HEX LAG
 SCREW
 QTY: 12

3/8 X 3-1/2"
 HEX LAG SCREW
 QTY: 12

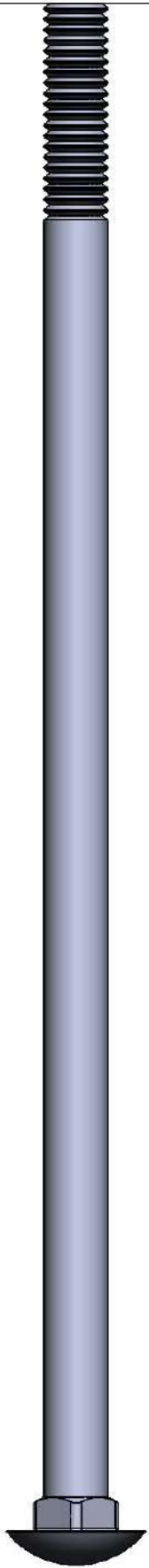

3/8 x 9"
 CARRIAGE BOLT
 QTY: 1

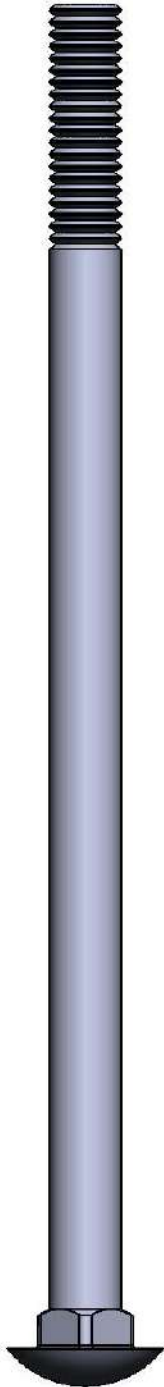

3/8 x 7"
 CARRIAGE BOLT
 QTY: 14

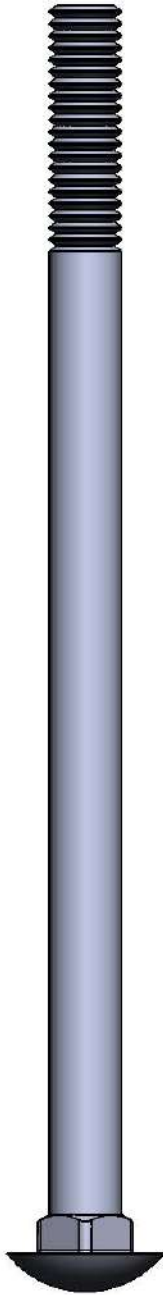

3/8 x 6-1/2"
 CARRIAGE BOLT
 QTY: 2

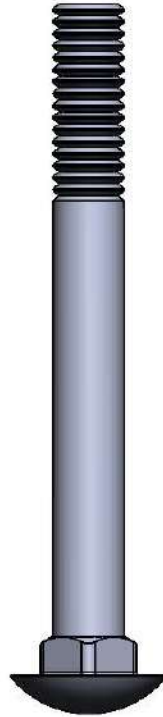

3/8 x 3-1/2"
 CARRIAGE BOLT
 QTY: 2

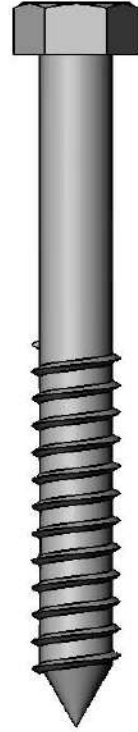
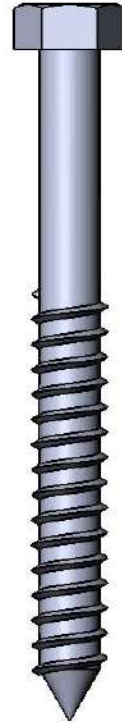

#2 SQUARE
 DRIVE BIT
 QTY: 1



PLASTIC
 BOLT CAP
 QTY: 19



USE THE RULER TO THE RIGHT TO MEASURE YOUR BOLTS AND SCREWS. PICTURE VIEWS SHOWN ABOVE ARE 1:1 SCALE AND CAN BE USED TO MATCH BOLT AND SCREW SIZES.



#14 X 1-1/4"
PAN HEAD SCREW
QTY: 10

#8 X 1-3/4"
WOOD SCREW
QTY: 4



#8 X 2-1/2"
WOOD SCREW
QTY: 14

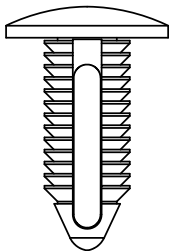

3/8" ϕ X 1-1/8"
BLACK PLASTIC
PLUG
QTY: 10

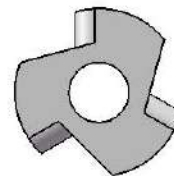

5/16" TEE NUT
QTY: 2



5/16 X 2-1/2"
HEX BOLT
QTY: 2

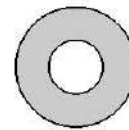

1/4" WASHER
QTY: 10

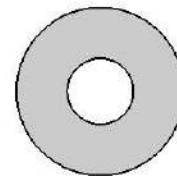

5/16" WASHER
QTY: 2

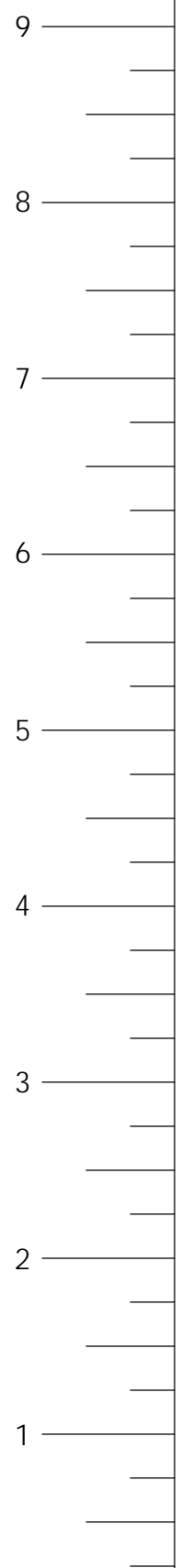

USE THE RULER TO THE RIGHT TO MEASURE YOUR BOLTS AND SCREWS. PICTURE VIEWS SHOWN ABOVE ARE 1:1 SCALE AND CAN BE USED TO MATCH BOLT AND SCREW SIZES.



#14 x 3"
 PAN HEAD SCREW
 QTY: 3

#8 X 2"
 WOOD SCREW
 QTY: 71



#8 X 2-1/2"
 WOOD SCREW
 QTY: 12



#8 X 3"
 WOOD SCREW
 QTY: 5

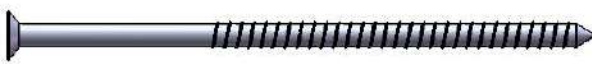

#10 x 3-1/2"
 WOOD SCREW
 QTY: 2

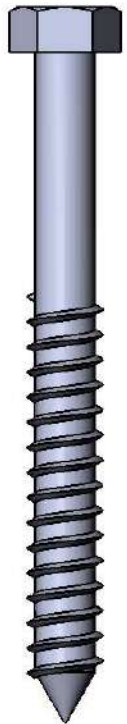

5/16" X 3-1/2"
 HEX LAG
 SCREW
 QTY: 31

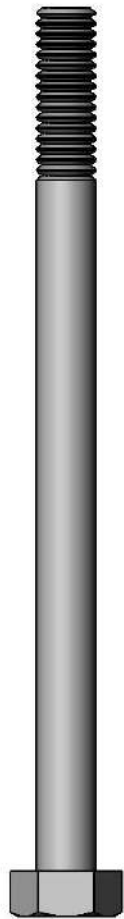

5/16 X 4-1/2"
 HEX BOLT
 QTY: 18

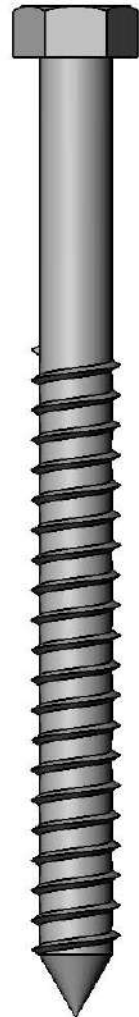

3/8 X 5"
 HEX LAG SCREW
 QTY: 4

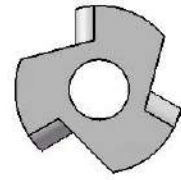

5/16" TEE NUT
 QTY: 18

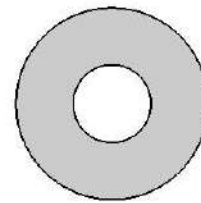

3/8" WASHER
 QTY: 4

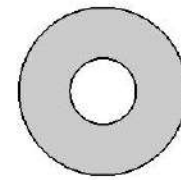

5/16" WASHER
 QTY: 49

USE THE RULER TO THE RIGHT TO MEASURE YOUR BOLTS AND SCREWS. PICTURE VIEWS SHOWN ABOVE ARE 1:1 SCALE AND CAN BE USED TO MATCH BOLT AND SCREW SIZES.



#14 X 1-1/4"
 PAN HEAD SCREW
 QTY: 10

#8 X 2-1/2"
 WOOD SCREW
 QTY: 14



5/16 X 2-1/2"
 HEX BOLT
 QTY: 1

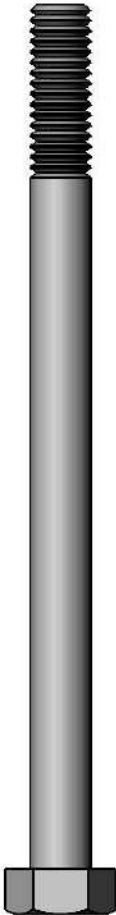

5/16 X 4-1/2"
 HEX BOLT
 QTY: 1

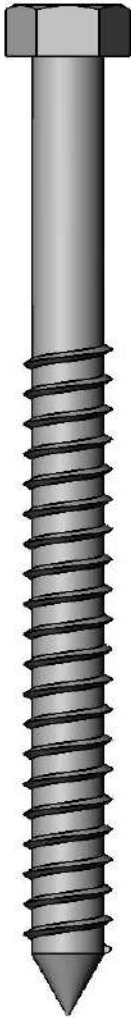

3/8" X 5"
 LAG SCREW
 QTY: 9

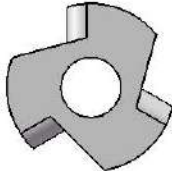

5/16" TEE NUT
 QTY: 2

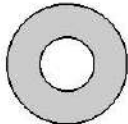

1/4" WASHER
 QTY: 10

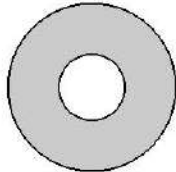

5/16" WASHER
 QTY: 2

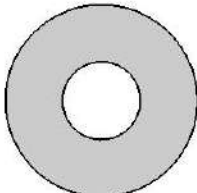

3/8" WASHER
 QTY: 9

USE THE RULER TO THE RIGHT TO MEASURE YOUR BOLTS AND SCREWS. PICTURE VIEWS SHOWN ABOVE ARE 1:1 SCALE AND CAN BE USED TO MATCH BOLT AND SCREW SIZES.

11-0071
 1509N HARDWARE
 PAGE: 1 OF 1
 REV A: 9/19/2014 JH



#14 x 1-1/4"
 PAN HEAD SCREW
 QTY: 6

#8 X 2"
 WOOD SCREW
 QTY: 94



#8 X 2-1/2"
 WOOD SCREW
 QTY: 18



#8 X 3"
 WOOD SCREW
 QTY: 5

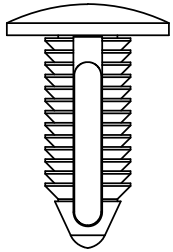

3/8" ϕ X 1-1/8"
 BLACK PLASTIC
 PLUG
 QTY: 4

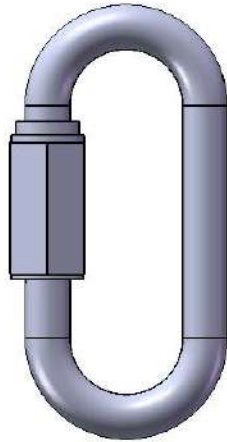

QUICK LINK
 QTY: 2

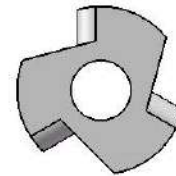

5/16" TEE NUT
 QTY: 55



5/16" X 3-1/2"
 HEX LAG
 SCREW
 QTY: 26



5/16 X 1-3/4"
 HEX BOLT
 QTY: 30

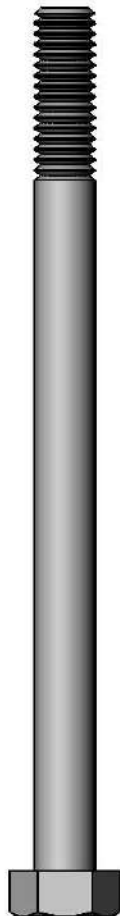

5/16 X 4-1/2"
 HEX BOLT
 QTY: 25

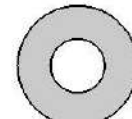

1/4" WASHER
 QTY: 6

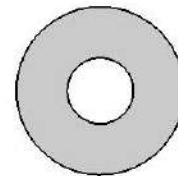

5/16" WASHER
 QTY: 111

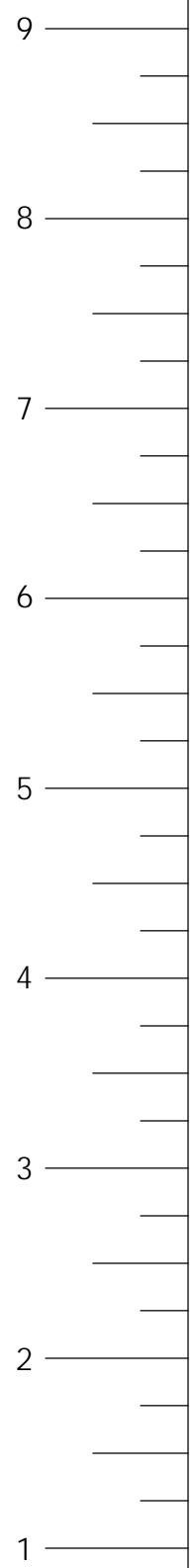

USE THE RULER TO THE RIGHT TO MEASURE YOUR BOLTS AND SCREWS. PICTURE VIEWS SHOWN ABOVE ARE 1:1 SCALE AND CAN BE USED TO MATCH BOLT AND SCREW SIZES.

9

8

7

6

5

4

3

2

1

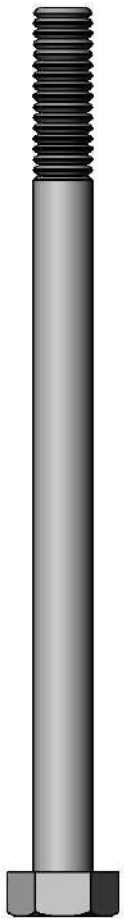

5/16 X 4-1/2"
HEX BOLT
QTY: 14

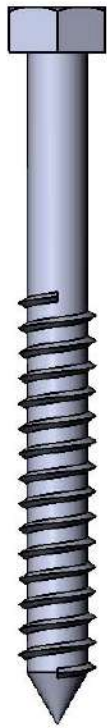

5/16" X 3-1/2"
LAG SCREW
QTY: 16



5/16" TEE NUT
QTY: 14

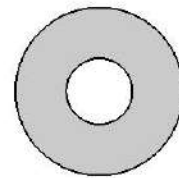

5/16" WASHER
QTY: 30

USE THE RULER TO THE RIGHT TO MEASURE YOUR BOLTS AND SCREWS. PICTURE VIEWS SHOWN ABOVE ARE 1:1 SCALE AND CAN BE USED TO MATCH BOLT AND SCREW SIZES.

#8 X 3"
WOOD SCREW
QTY: 5

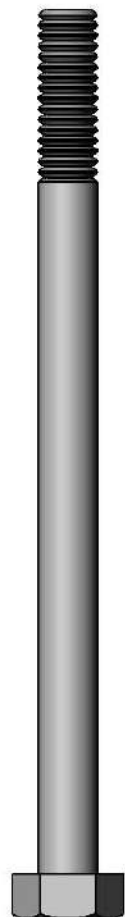

5/16 X 4-1/2"
HEX BOLT
QTY: 1

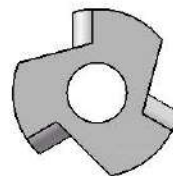

5/16" TEE NUT
QTY: 1

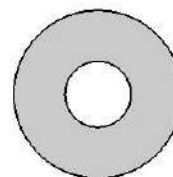

5/16" WASHER
QTY: 1

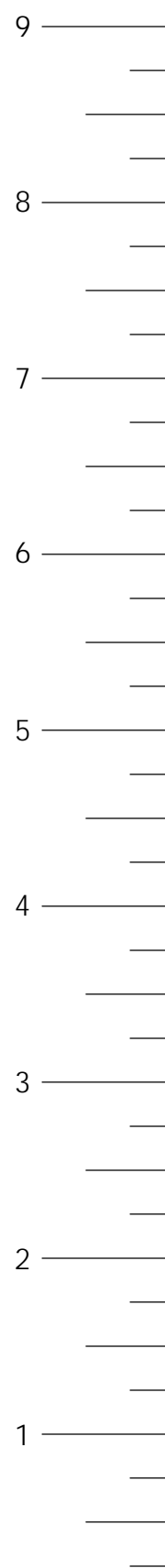

USE THE RULER TO THE RIGHT TO MEASURE YOUR BOLTS AND SCREWS. PICTURE VIEWS SHOWN ABOVE ARE 1:1 SCALE AND CAN BE USED TO MATCH BOLT AND SCREW SIZES.

11-2027
SUB BRACKET
HARDWARE
12/09/2015
JH

3/8" X 2-1/2"
LAG SCREW
QTY: 4

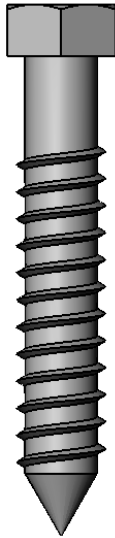

3/8" WASHER
QTY: 4

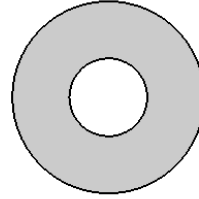

9
8
7
6
5
4
3
2
1

USE THE RULER TO THE RIGHT TO MEASURE YOUR BOLTS AND SCREWS. PICTURE VIEWS SHOWN ABOVE ARE 1:1 SCALE AND CAN BE USED TO MATCH BOLT AND SCREW SIZES.

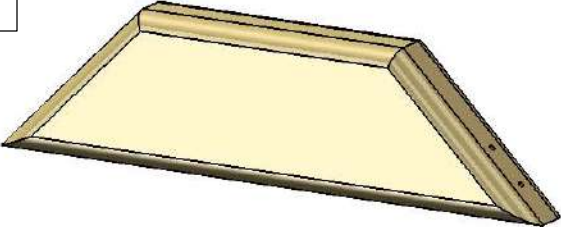
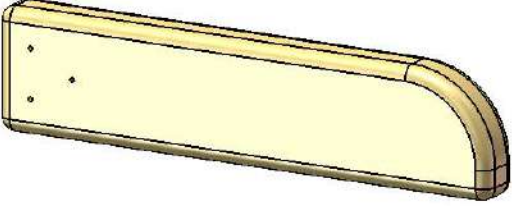
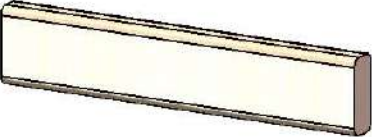
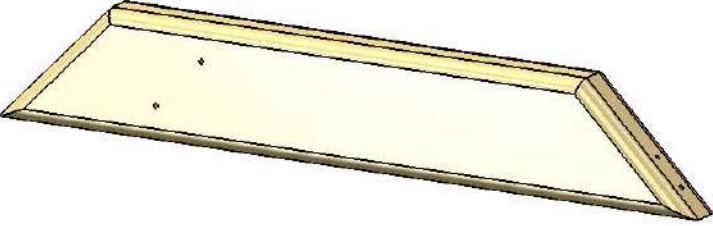
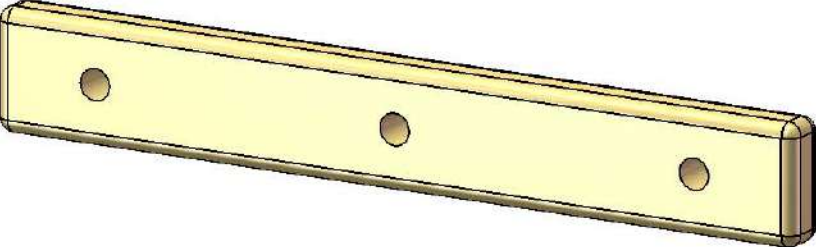
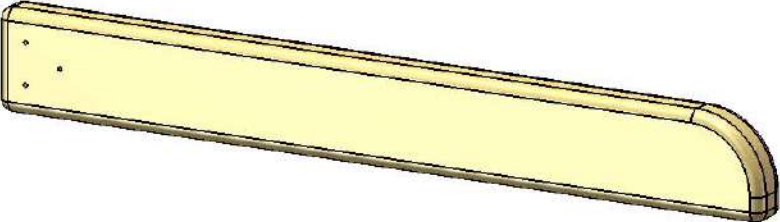
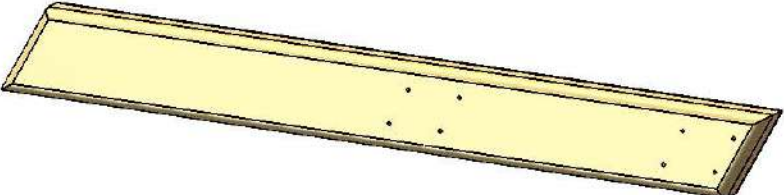
	PICTURE	DESCRIPTION	QTY.
1501		2 X 4 X 13" ANGLE SUPPORT 2-4-1300-AS	4
		2 X 4 X 14-3/4" PICNIC TABLE TOP SUPPORT 2-4-1475-PTTS	2
		2 X 4 X 17" LADDER STEP 2-4-1700-LS	5
		2 X 4 X 18" ANGLE SUPPORT 2-4-1800-AS	4
		2 X 4 X 24" ROPE LADDER STEP 2-4-2400-RLST	6
		2 X 4 X 27-1/2" PICNIC TABLE SEAT SUPPORT 2-4-2750-PTSS	2
		2 X 4 X 32-1/2" PICNIC TABLE LEG 2-4-3250-PTL	2

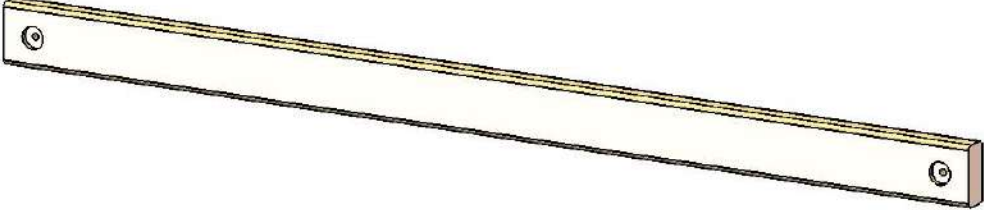
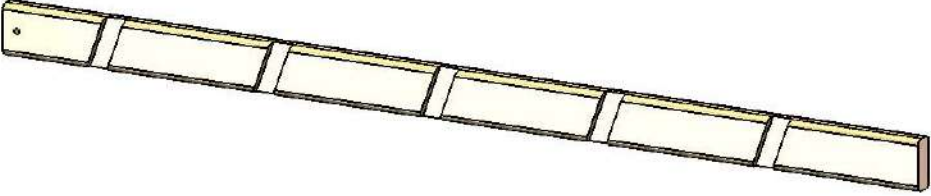
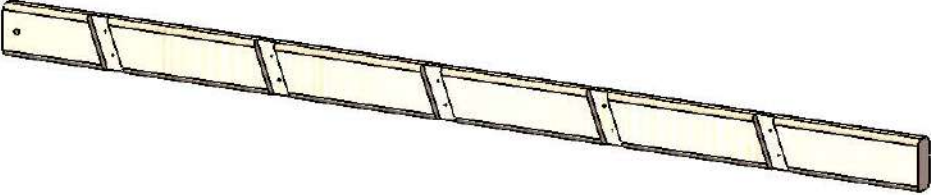
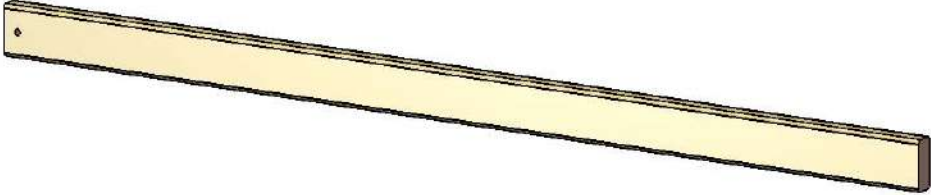
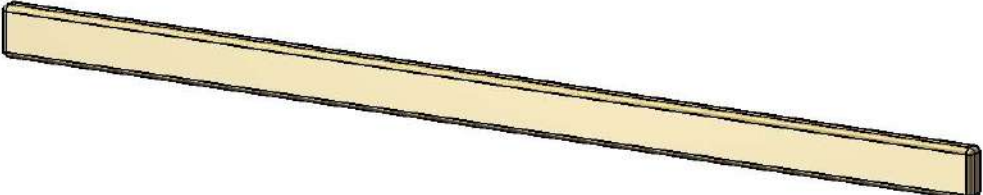
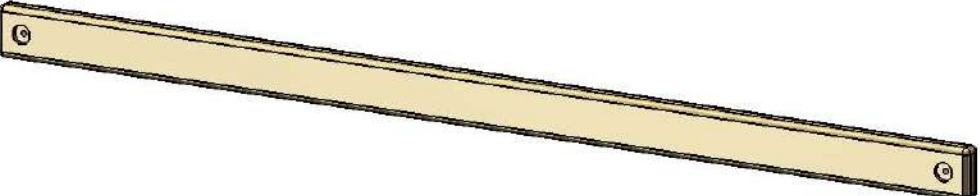
PICTURE	DESCRIPTION	QTY.
	2 X 4 X 47-1/2" SAFETY/END PANEL BOARD 2-4-4750-SBEP	2
	2 X 4 X 58" SWING BEAM CROSS MEMBER 2-4-5800-CM	1
	2 X 4 X 66" LADDER RIGHT SIDE 2-4-6600-LRS	1
	2 X 4 X 66" LADDER LEFT SIDE 2-4-6600-LLS	1
	2 X 4 X 66" ROCK WALL SIDE 2-4-6600-RWS	2
	2 X 4 X 70" CENTER DECK SUPPORT 2-4-7000-CDS	1
	2 X 4 X 70" DECK SUPPORT 2-4-7000-DS	2

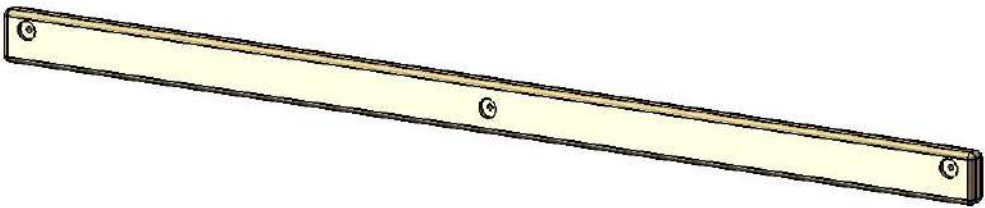
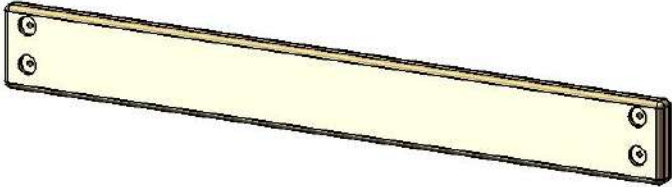
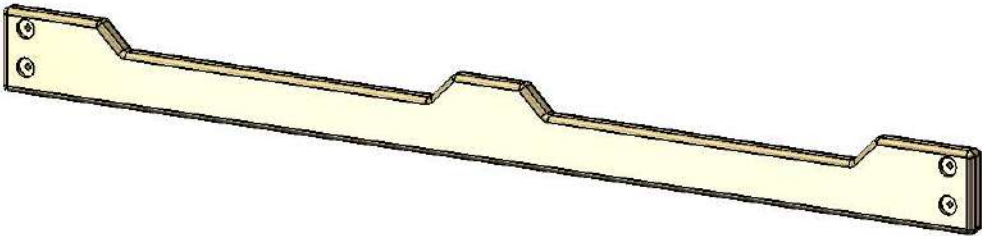
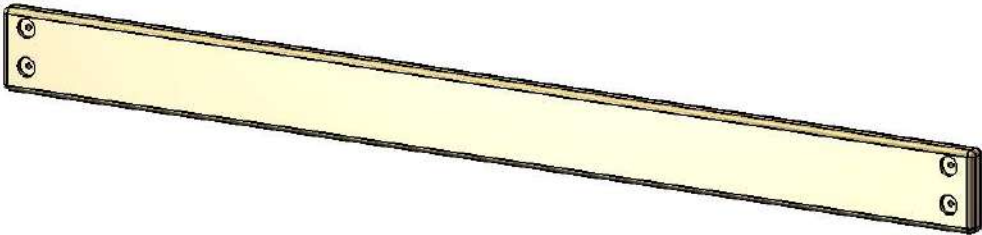
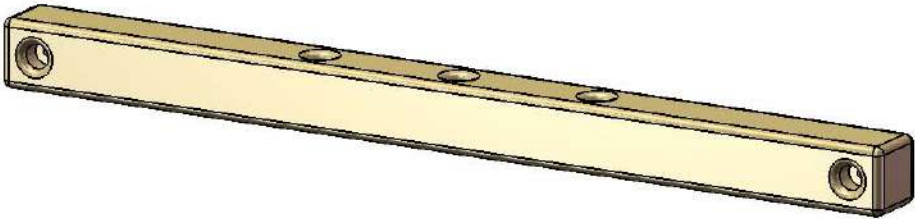
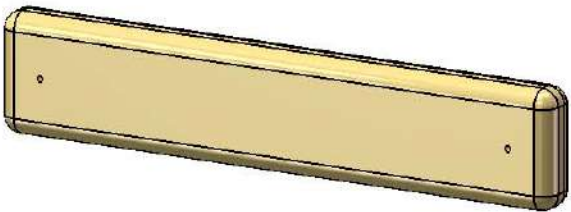
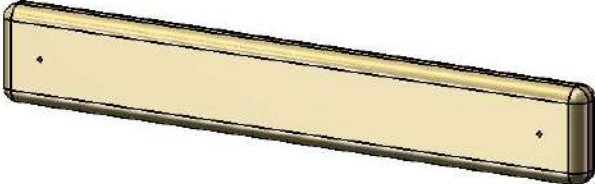
PICTURE	DESCRIPTION	QTY.
	<p>2 x 4 x 70" REAR TOP PANEL BOARD 2-4-7000-RTPB</p>	<p>1</p>
	<p>2 x 6 x 47-1/2" END SANDBOX/ BOTTOM PANEL BOARD 2-6-4750-ESPB</p>	<p>2</p>
	<p>2 x 6 x 70" FRONT FACE BOARD 2-6-7000-FFB</p>	<p>1</p>
	<p>2 x 6 x 70" SANDBOX BOARD 2-6-7000-SB</p>	<p>1</p>
	<p>4 x 4 x 47-1/2" SWING BEAM MOUNT 4-4-4750-SBM</p>	<p>1</p>
	<p>5/4 X 3 X 13-1/4" PICNIC TABLE SLAT 125-3-1325-PTS</p>	<p>2</p>
	<p>5/4 X 3 X 17-1/2" TIC TAC TOE MOUNT 125-3-1750-TTMM</p>	<p>2</p>

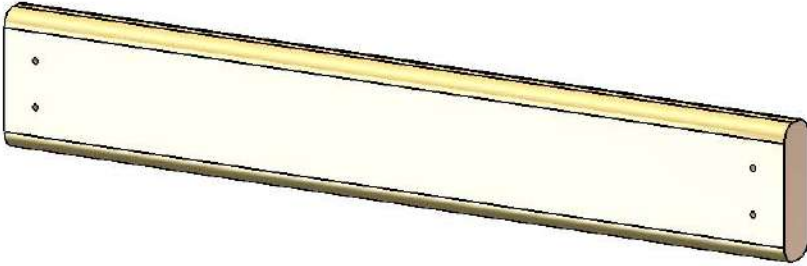
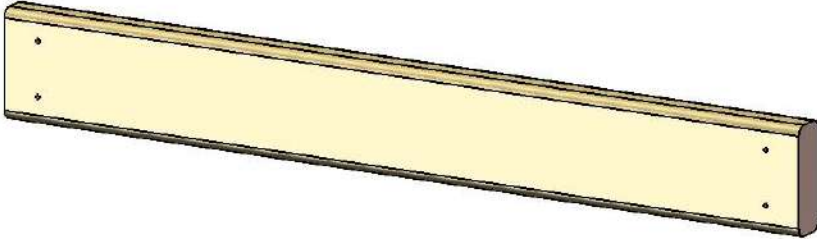
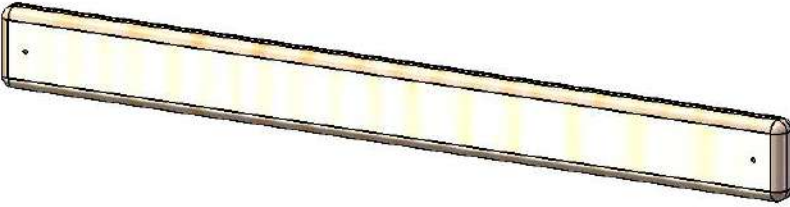
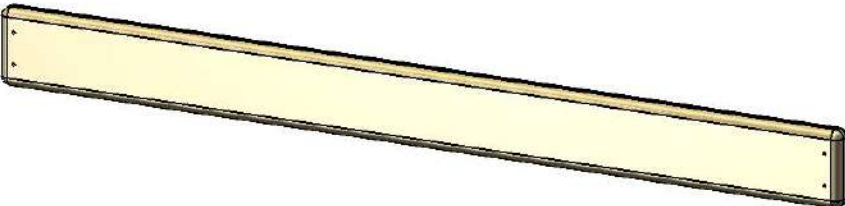
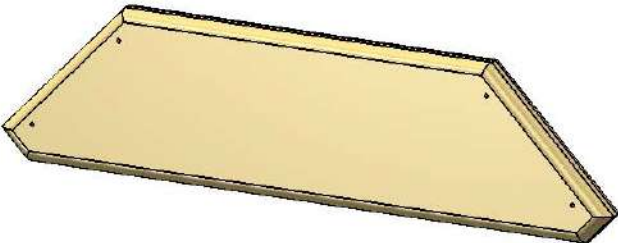
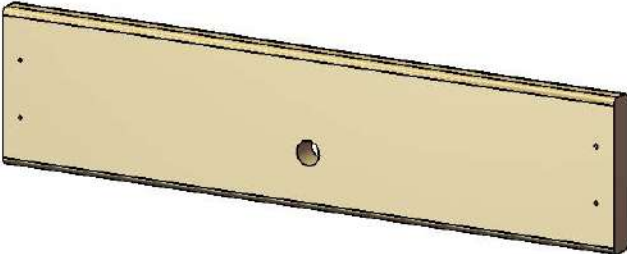
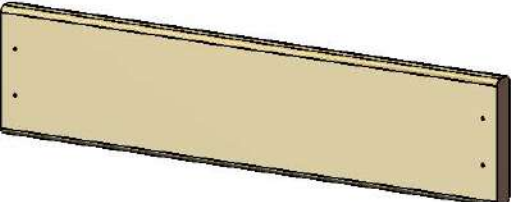
PICTURE	DESCRIPTION	QTY.
	<p>5/4 X 3 X 18-3/4" LADDER BACK 125-3-1875-LB</p>	<p>1</p>
	<p>5/4 X 3 X 23-7/8" ROCK WALL CAP 125-3-2387-RWC</p>	<p>1</p>
	<p>5/4 X 3 X 28-1/4" PANEL SLATS 125-3-2825-PS</p>	<p>14</p>
	<p>5/4 X 4 X 40-3/8" DECK SPACER 125-4-4038-DS</p>	<p>2</p>
	<p>5/4 X 6 X 22" SANDBOX SEAT 125-6-2200-SS</p>	<p>2</p>
	<p>5/4 X 6 X 23-7/8" BOTTOM ROCK WALL BOARD 125-6-2387-BRW</p>	<p>1</p>
	<p>5/4 X 6 X 23-7/8" ROCK WALL BOARD 125-6-2387-RWB</p>	<p>11</p>

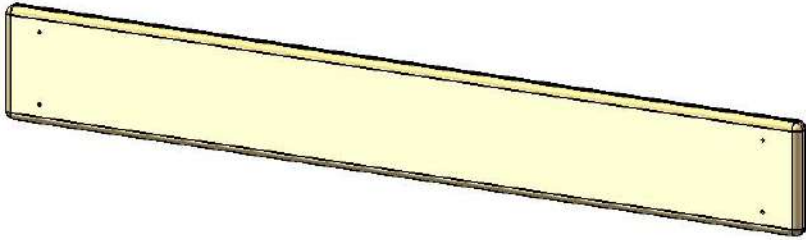
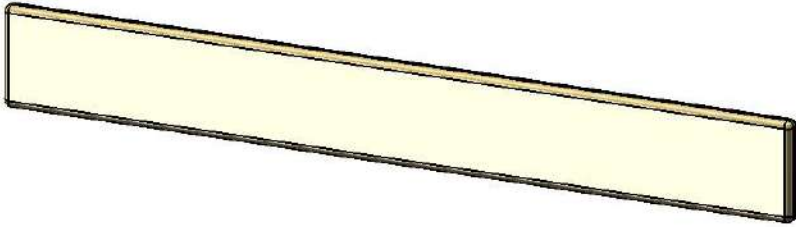
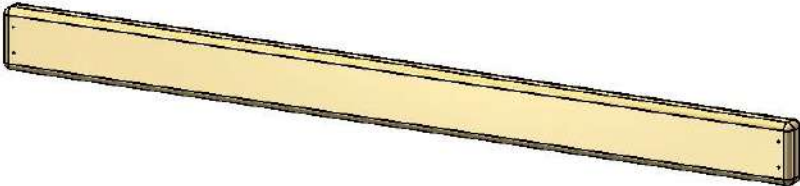
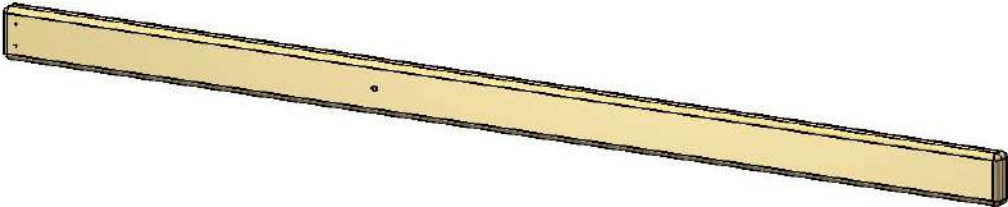
PICTURE	DESCRIPTION	QTY.
	<p>5/4 X 6 X 43" PICNIC TABLE & SEAT BOARD 125-6-4300-PTTS</p>	<p>4</p>
	<p>5/4 X 6 X 47-3/8" DECK BOARD 125-6-4737-DB</p>	<p>11</p>
<p>1502</p>		
	<p>2 X 4 X 47-3/8" TARP BOARD 2-4-4738-TB</p>	<p>3</p>
	<p>2 X 4 X 71-7/8" CENTER TARP SUPPORT 2-4-7188-CTS</p>	<p>2</p>
		<p>30</p>

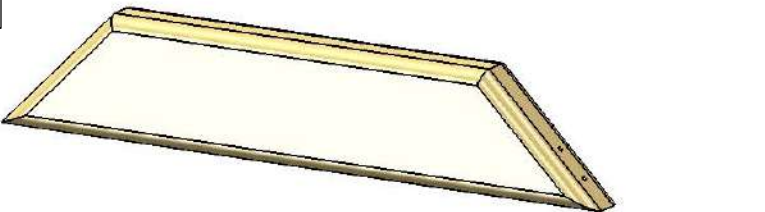
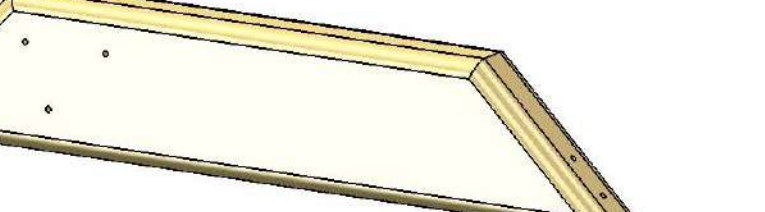
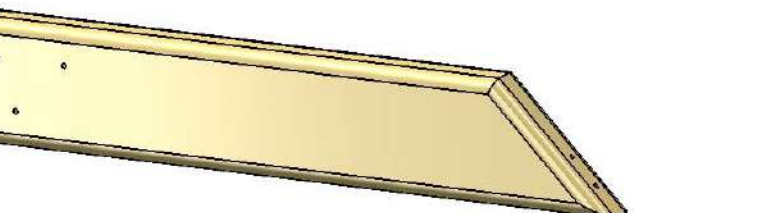
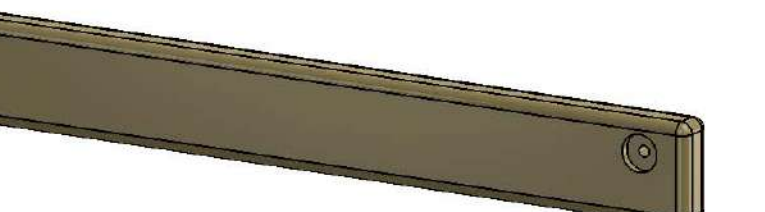
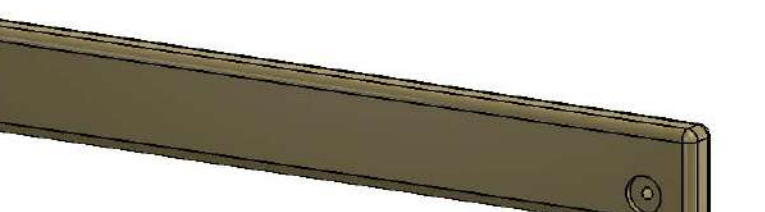
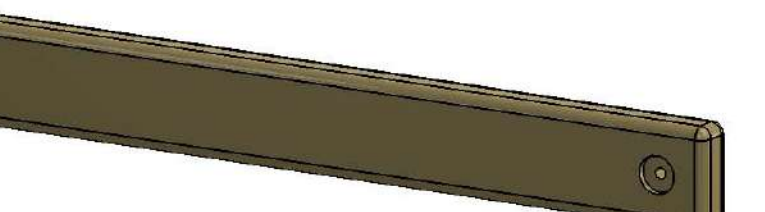
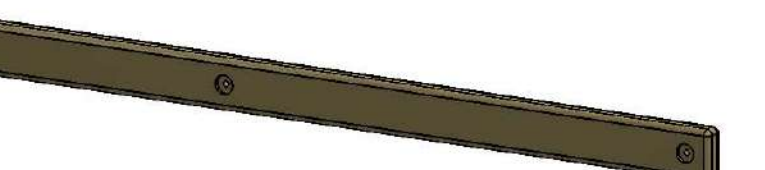
	PICTURE	DESCRIPTION	QTY.
1504		2 X 4 X 18" ANGLE SUPPORT- UPPER LEVEL RAD RIDE SIDE 2-4-1800-ULRDAS	1
		2 X 4 X 18" ANGLE SUPPORT- UPPER LEVEL REAR 2-4-1800-ULRAS	2
		2 X 4 X 21-1/2" ANGLE SUPPORT- UPPER LEVEL SWING SIDE 2-4-2150-ULSAS	1
		2 X 4 X 30-7/16" SIDE TOP PANEL BOARD 2-4-3043-STPB	2
		2 X 4 X 34" UPPER LEVEL CENTER DECK SUPPORT 2-4-3400-CDS	2
		2 X 4 X 34" UPPER LEVEL DECK SUPPORT/ SAFETY BOARD 2-4-3400-UDS	3
		2 X 4 X 70" UPPER LEVEL STEPS/RAILING 2-4-7000-ULSR	5

PICTURE	DESCRIPTION	QTY.
	2 X 6 X 30-7/16" SIDE BOTTOM PANEL BOARD 2-6-3043-SBPB	2
	2 X 6 X 42-1/2" REAR BOTTOM PANEL BOARD 2-6-4250-RBPB	1
	2 X 6 X 70" BACK PANEL BOARD 2-6-7000-BPB5	1
	4 X 4 X 23-1/2" SLIDE BLOCK 4-4-2350-SB	1
	4 X 4 X 30-1/2" CENTER BLOCK SUPPORT 4-4-3050-CBS	1
	4 X 4 X 43-1/2" RAD RIDE CENTER POST 4-4-4350-RCP	1
	4 X 4 X 70" UPPER LEVEL UNDER DECK SUPPORT 4-4-7000-UDS	1

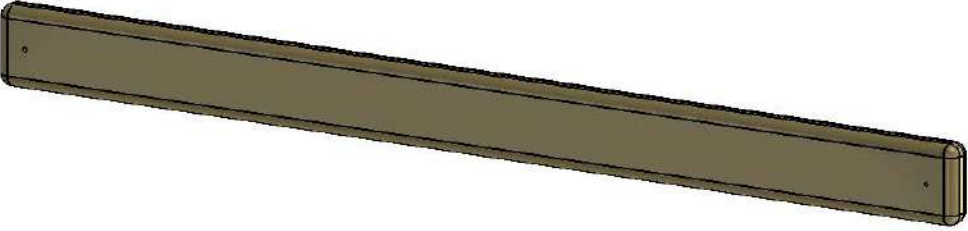
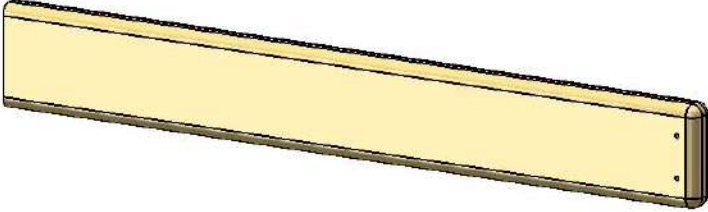
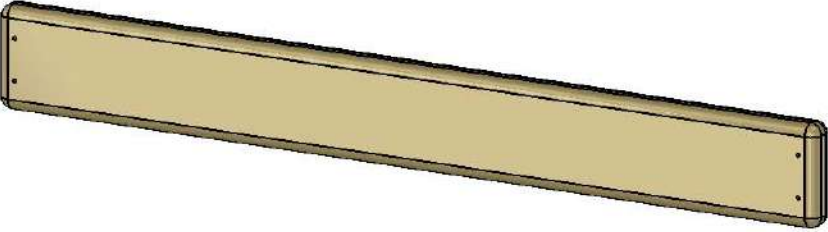
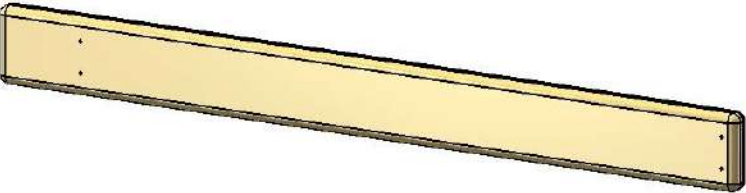
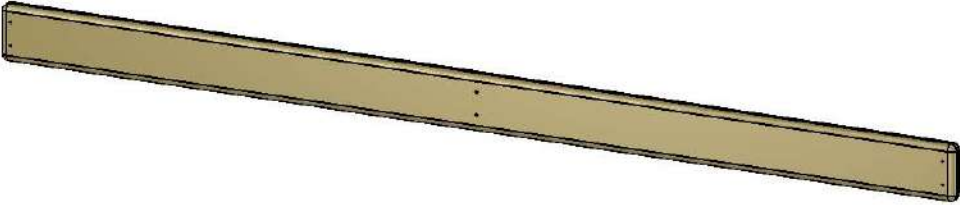
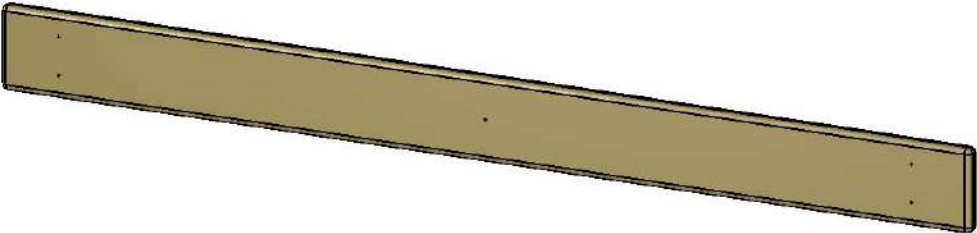
PICTURE	DESCRIPTION	QTY.
	<p>5/4 X 3 X 34-1/2" PANEL SLAT 125-3-3450-PS</p>	<p>13</p>
	<p>5/4 X 4 X 25" RAD RIDE DECK SPACER 125-4-2500-RRDS</p>	<p>1</p>
	<p>5/4 X 4 X 29-1/2" UPPER DECK SPACER 125-4-2950-UDS</p>	<p>2</p>
	<p>5/4 X 4 X 35-1/2" REAR DECK SPACER 125-4-3550-RDS</p>	<p>1</p>
	<p>5/4 X 4 X 63" UPPER DECK SPACER 125-4-6300-UDS</p>	<p>1</p>
	<p>5/4 X 6 X 69-7/8" UPPER DECK BOARD 125-6-6988-USB</p>	<p>4</p>
		<p>33</p>

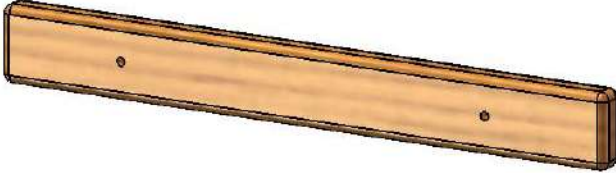
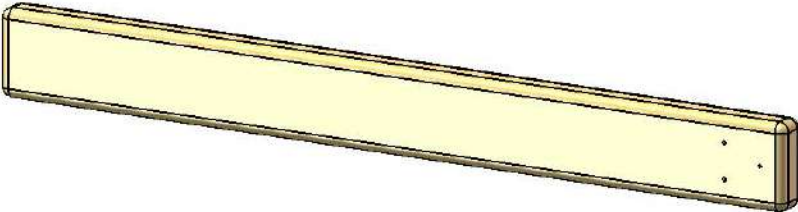
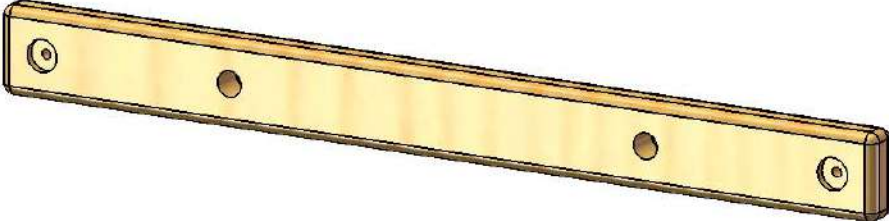
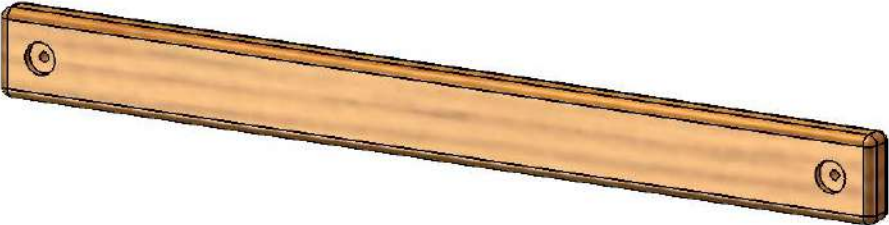
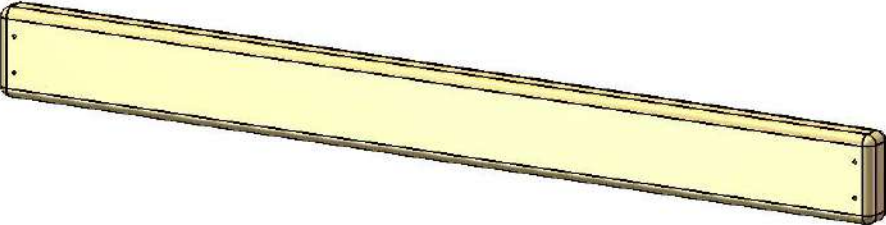
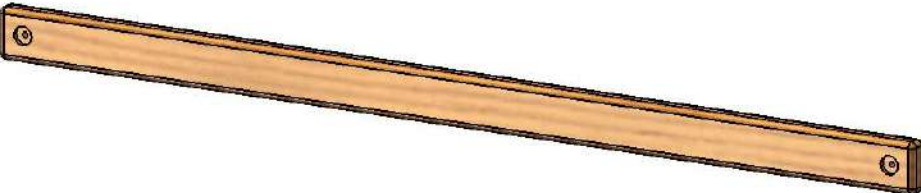
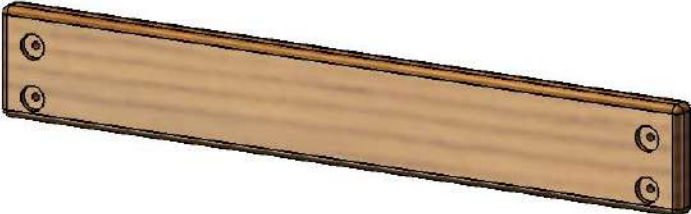

1505	PICTURE	DESCRIPTION	QTY.
		2 X 4 X 30-1/2" TARP BOARD 2-4-3050-TB	3
		2 X 4 X 69-5/8" REAR CENTER POST-UPPER LEVEL 2-4-6963-RCPUL	1
		4 X 4 X 60-1/4" LAG POST - LEFT 4-4-6025-LPTL	1
		4 X 4 X 60-1/4" LAG POST - RIGHT 4-4-6025-LPTR	1
		4 X 4 X 69-3/4" CENTER LAG POST- UPPER LEVEL 4-4-6975-CLPUL	1
		4 X 4 X 71-7/8" REAR CENTER POST- LOWER LEVEL 4-4-7188-RCPLL	1
			34

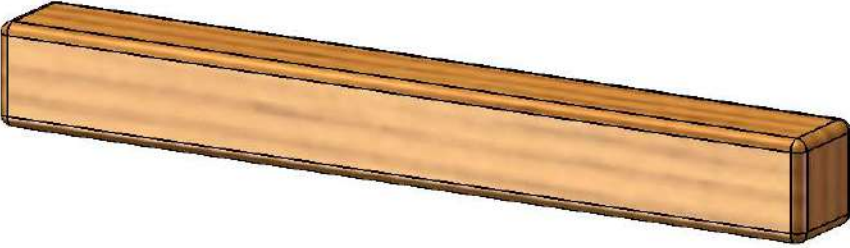
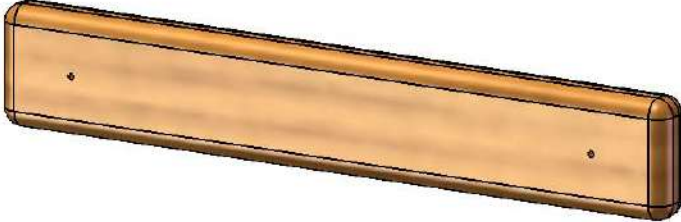
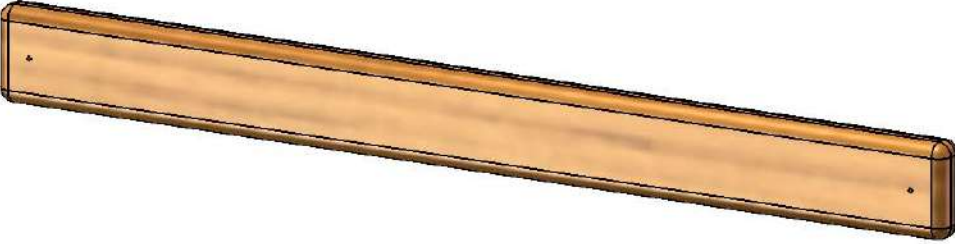
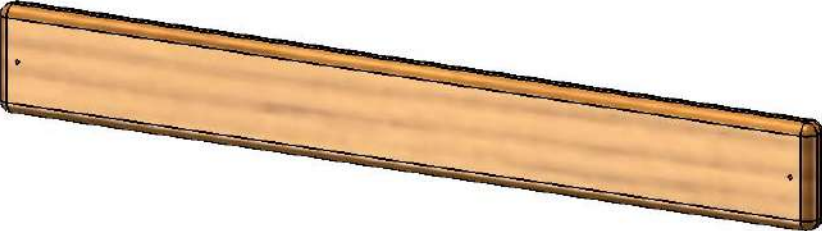
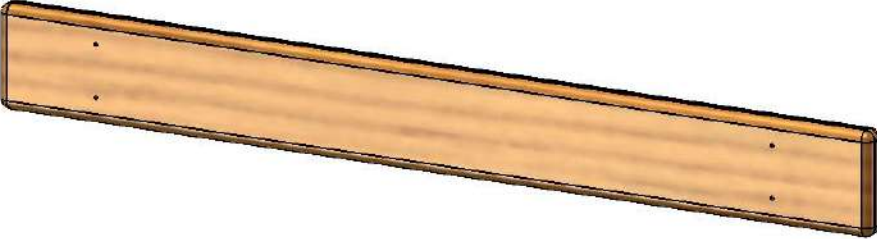
1509	PICTURE	DESCRIPTION	QTY.
		2 X 4 X 29" BRIDGE DECK 2-4-2900-BD	15
		2 X 4 X 33" VERTICAL TARP SUPPORT 2-4-3300-VTS	2
		2 X 4 X 36-3/4" SAFETY BOARD WITH CHAIN HOLES 2-4-3675-SBH	2
		2 X 4 X 36-3/4" DECK SUPPORT/ TOP PANEL/ SAFETY BOARD 2-4-3675-SB	6
		2 X 4 X 36-3/4" TARP BOARD 2-4-3675-TB	3
		2 X 4 X 66" RAIL 2-4-6600-R	4
		2 X 6 X 36-3/4" BOTTOM PANEL/ SANDBOX BOARD 2-6-3675-BPB	6

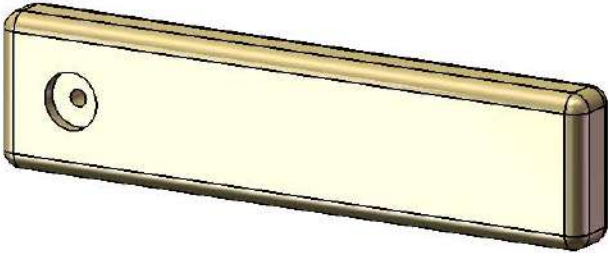
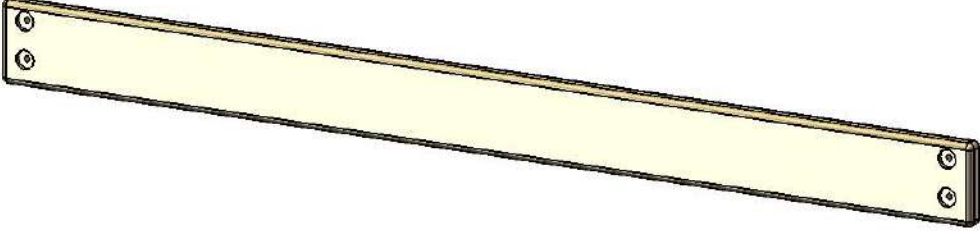
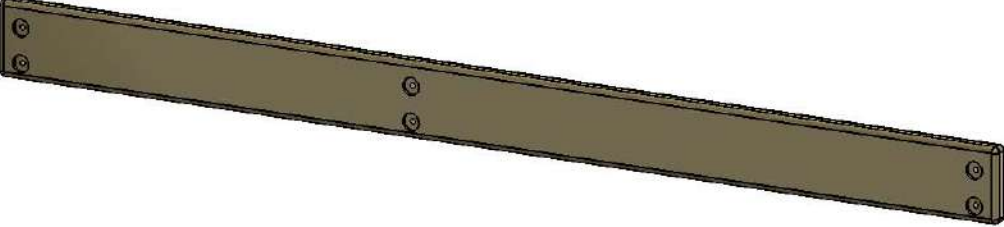
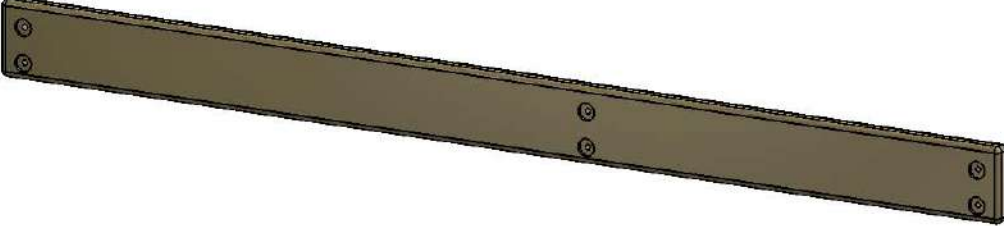
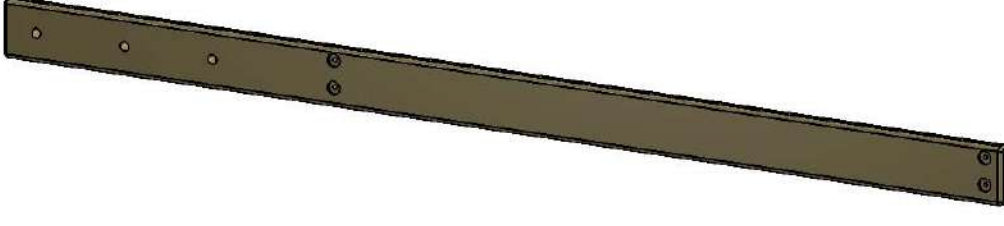
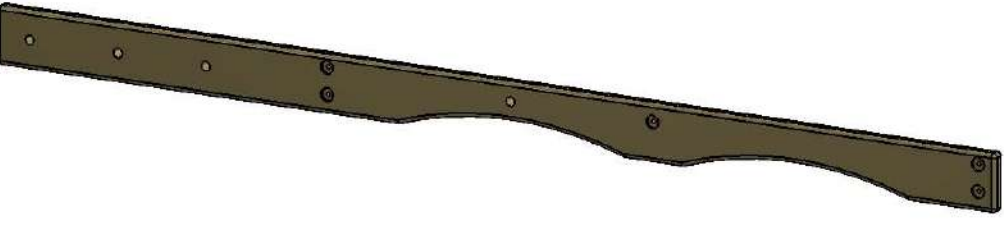
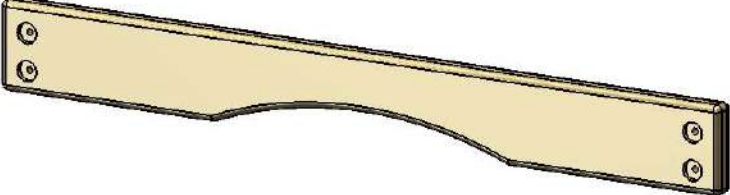
PICTURE	DESCRIPTION	QTY.
	<p>4 X 4 X 29" CENTER POST 4-4-2900-CP</p>	<p>1</p>
	<p>5/4 X 3 X 16" RAIL SLAT 125-3-1600-RS</p>	<p>20</p>
	<p>5/4 X 3 X 28-1/2" PANEL SLAT 125-3-2850-PS</p>	<p>11</p>
	<p>5/4 X 4 X 29-3/8" DECK SPACER 125-4-2937-DS</p>	<p>2</p>
	<p>5/4 X 4 X 36-11/16" DECK BOARD 125-4-3668-DB</p>	<p>7</p>
		<p>36</p>

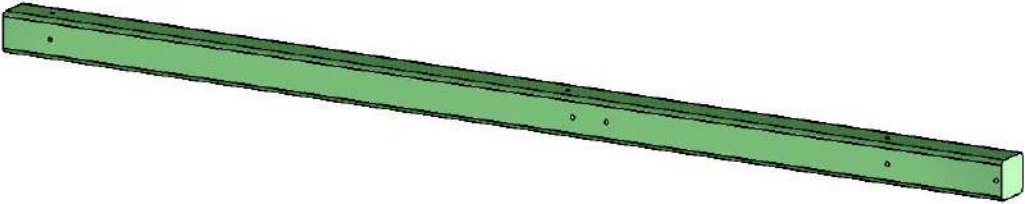
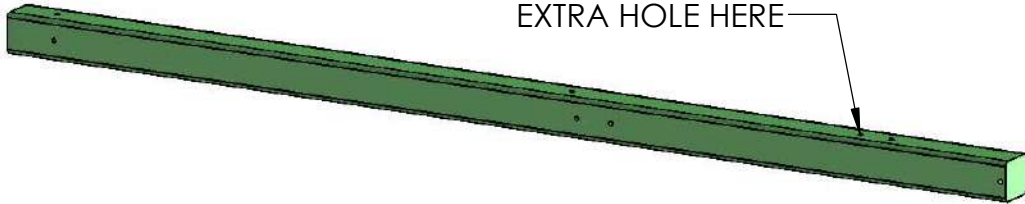
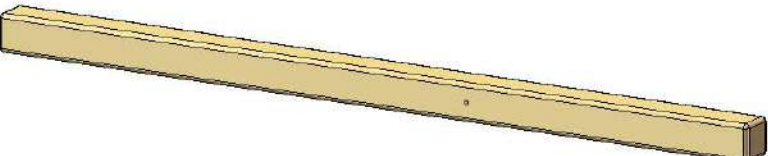
	PICTURE	DESCRIPTION	QTY.
1515		2 X 4 X 14" BOTTOM PANEL BOARD 2-4-1400-BPB	2
		2 X 6 X 70" SANDBOX BOARD 2-6-7000-SB	1
		2 X 6 X 78" SIDE SANDBOX BOARD-LEFT 2-6-7800-SBL	1
		2 X 6 X 78" SIDE SANDBOX BOARD-RIGHT 2-6-7800-SBR	1
		2 X 6 X 102" ROPE LADDER RUNNER- FRONT LEFT 2-6-10200-RLRFL	1
		2 X 6 X 102" ROPE LADDER SUPPORT-FRONT LEFT 2-6-10200-RLSFL	1
		2 X 6 X 47-1/2" TOP PANEL BOARD 2-6-4750-TPB	1

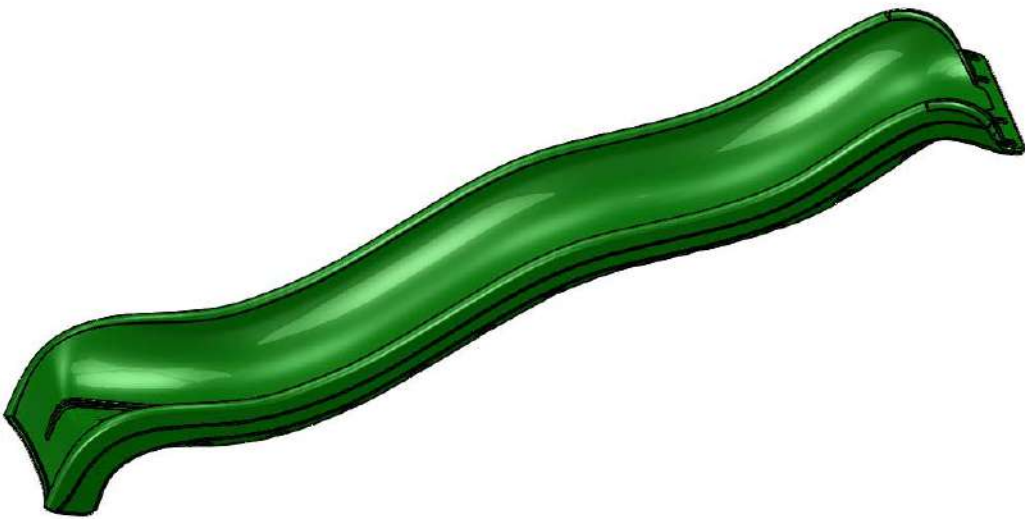
PICTURE	DESCRIPTION	QTY.
	4 X 4 X 96" PLASTIC COATED CORNER POST- FRONT	2
 <p>EXTRA HOLE HERE</p>	4 X 4 X 96" PLASTIC COATED CORNER POST- MIDDLE	2
	4 X 4 X 120" PLASTIC COATED CORNER POST- REAR	2
	4 X 4 X 108" SWING LEG	2
	4 X 6 X 120" SWING BEAM	1
	4 X 4 X 96" PLASTIC COATED CORNER POST	4
1517		
	4 X 4 X 72" CENTER TARP SUPPORT TO ATTACH CBRIDGE RAIL	1

PICTURE	DESCRIPTION	QTY.
	<p>WAVE SLIDE 03-0013</p>	<p>1</p>
	<p>SUB BRACKET 11-5017</p>	<p>1</p>
	<p>RAD RIDE SLIDE 03-0002</p>	<p>1</p>

PICTURE

DESCRIPTION

QTY.

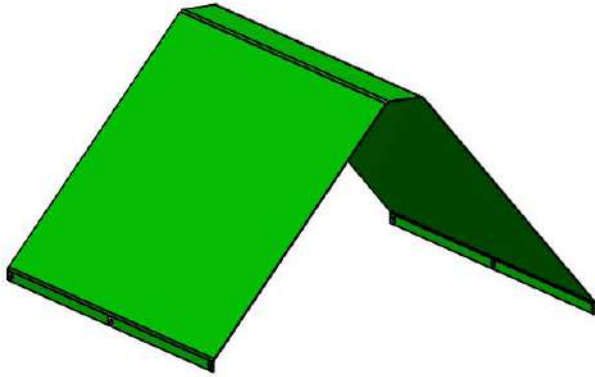

CLATTER-
BRIDGE TARP
57-1/2" X 34-1/4"
05-1012

1

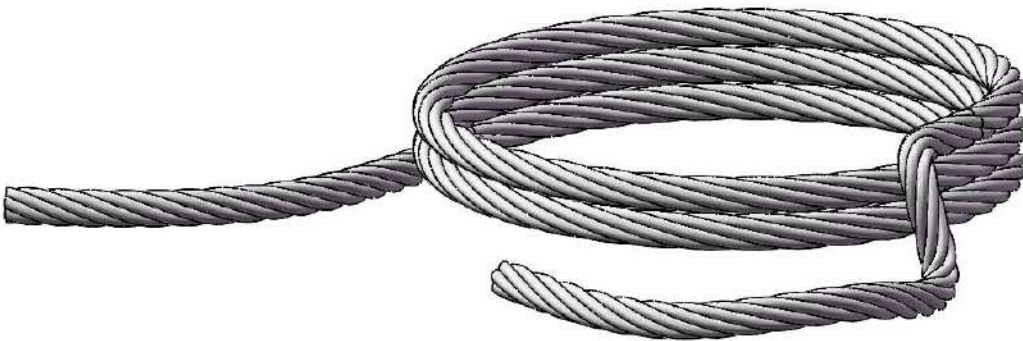

10'
ROCK
WALL

1

13'
ROPE
LADDER
ROPES

3



SWING
W/CHAINS
04-0002

2



TRAPEZE
BAR
W/CHAINS
04-0006

1

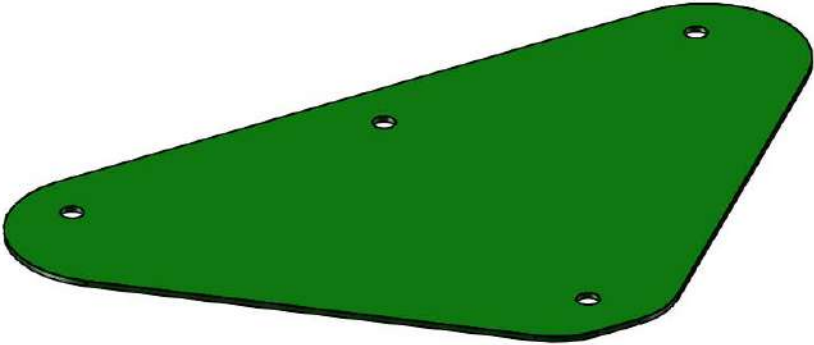
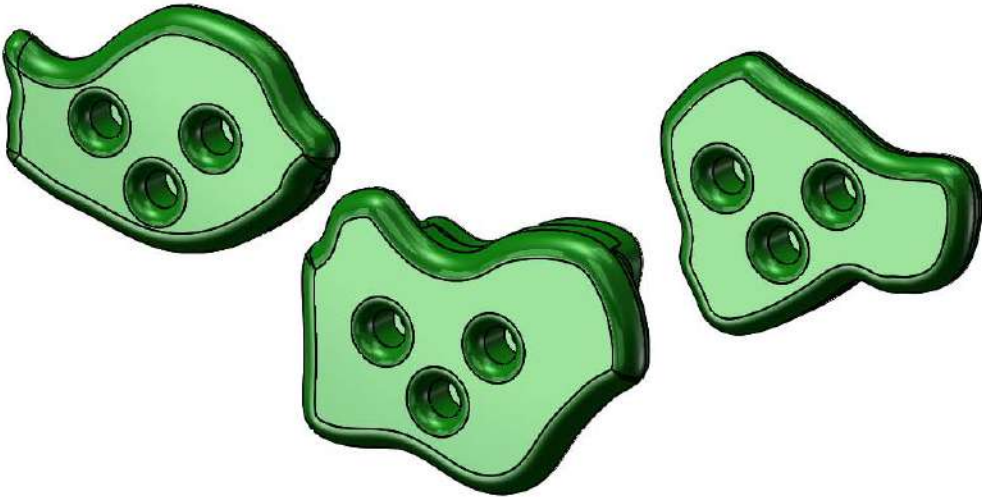
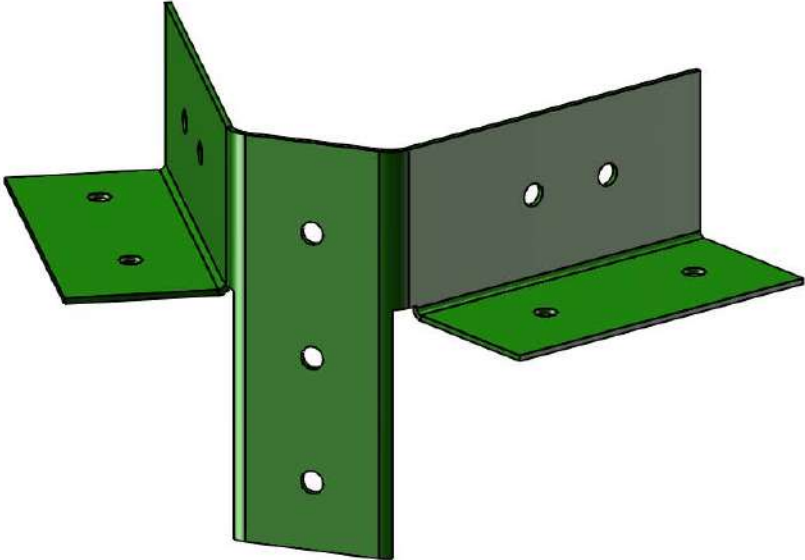
PICTURE	DESCRIPTION	QTY.
	<p>SWING PLATE 11-5002</p>	<p>1</p>
	<p>CLIMBING ROCK (5 ROCKS ARE IN ONE BAG) 07-0008</p>	<p>10</p>
	<p>A-FRAME SWING LEG BRACKET 11-5010</p>	<p>1</p>
<p>HARDWARE BOXES: 1501, 1502, 1504, 1505, 1509, 1515, 1517, 11-2027</p>	<p>HARDWARE BOXES INSTRUCTIONS</p>	<p>1 EA.</p>

PICTURE

DESCRIPTION

QTY.

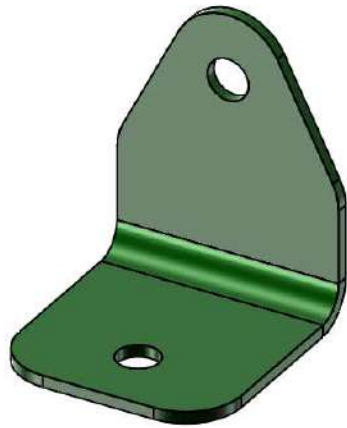

90° GREEN
BRACKET
11-5013

4

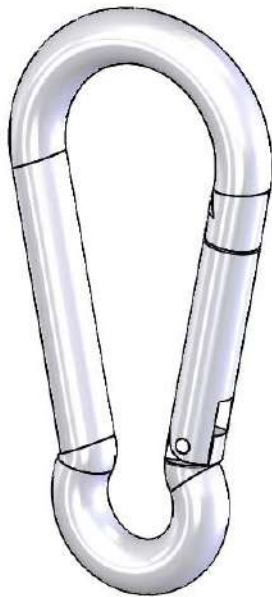



SPRING
CLIP
11-4003

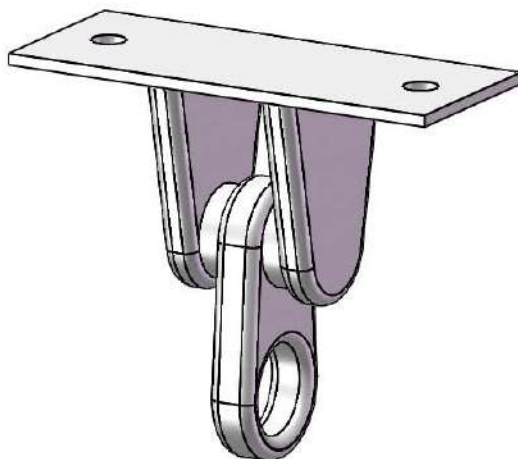

6



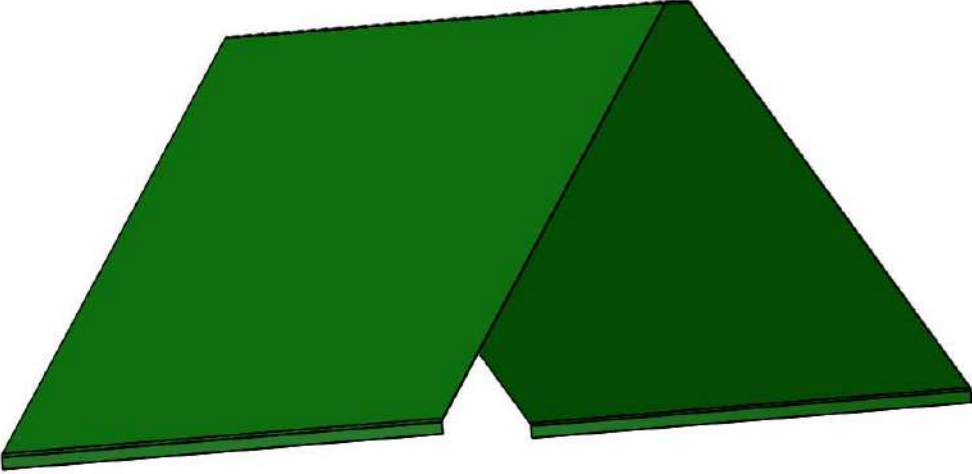
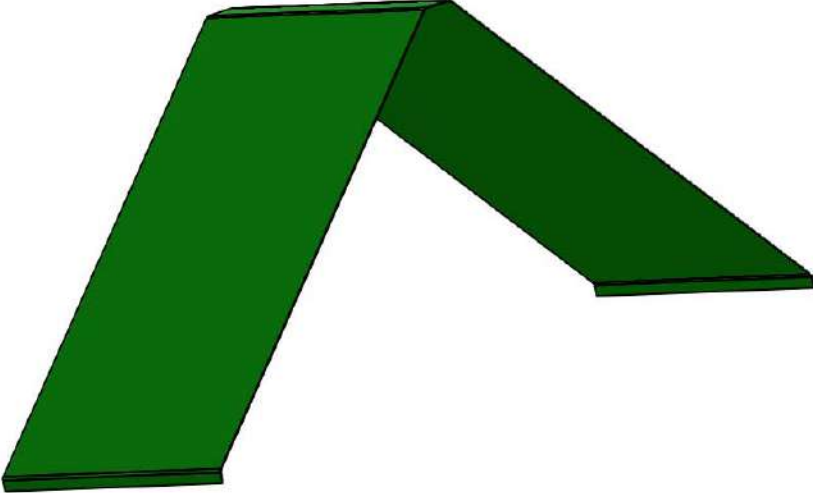

IRON
DUCTILE
SWING
HANGER
11-4012

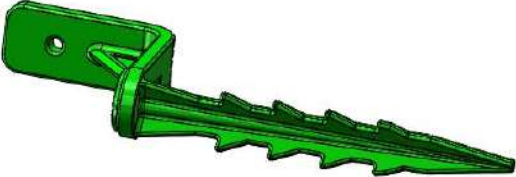
6

PICTURE	DESCRIPTION	QTY.
	<p>LOWER LEVEL TARP 47-3/8 X 105" (MATERIAL AND COLOR WILL VARY BY MODEL) 05-0010</p>	<p>1</p>
	<p>UPPER LEVEL TARP 30-1/4 X 105" (MATERIAL AND COLOR WILL VARY BY MODEL) 05-0011</p>	<p>1</p>
	<p>TELESCOPE 07-0001</p>	<p>1</p>
	<p>FLAG KIT 09-1014</p>	<p>2</p>

PICTURE	DESCRIPTION	QTY.
<p>(NOT SHOWN)</p>	<p>MANUFACTURER LOGO PLATE</p>	<p>1</p>
	<p>GROUND STAKE (PAIR) 07-0016-P</p>	<p>1 PR</p>
	<p>TIC TAC TOE (UNASSEMBLED) 07-0010</p>	<p>1</p>
	<p>STEERING WHEEL 07-0004</p>	<p>1</p>

PICTURE	DESCRIPTION	QTY.
	SAFETY HANDLE (2 HANDLES ARE IN ONE BAG) 07-0005	6
	CLATTER-BRIDGE CHAIN 96"	2
	SUPER SCOOP SLIDE	1
(NOT SHOWN)	CLATTER BRIDGE MESH PANEL (PAIR) 06-2004	1 PR

STEP 1: ATTACHING T-NUTS TO THE CORNER POSTS

1: THIS STEP IS CRITICAL TO BUILDING THE FORT PROPERLY. IF ANY MISTAKES ARE MADE HERE, YOU WILL NEED TODIS-ASSEMBLE AND THEN RE-ASSEMBLE TO MAKE YOUR CORRECTIONS.

2: MAKE SURE HOLES ARE FREE OF ANY OBSTRUCTIONS. USE A BOLT TO CLEAN OUT ANY DEBRIS.

3: LAY OUT EACH OF THE 4 X 4 X 96" CORNER POSTS IN THE AREA YOU INTEND ON BUILDING THE FORT SIDE OF THE PLAYSET.

4: USE THE DIAGRAM BELOW TO CORRECTLY IDENTIFY AND ORIENT THE NECESSARY DIRECTION THE POSTS SHOULD FACE.

5: USE A HAMMER TO SEAT THE T-NUTS AFTER INSERTING THEM INTO THE HOLES SHOWN IN THE DIAGRAM BELOW.

6: THE BARREL OF THE T-NUT SHOULD GO IN THE HOLE FIRST. HAMMER THE T-NUT UNTIL IT IS FLUSH/ALMOST FLUSH TO THE CORNER POSTS.

7: PLACE A PLASTIC PLUG INTO ALL THE CORNER POST TOP HOLES. USE A DAB OF SILICONE ON THE PLUGS TO SEAL THE HOLES.

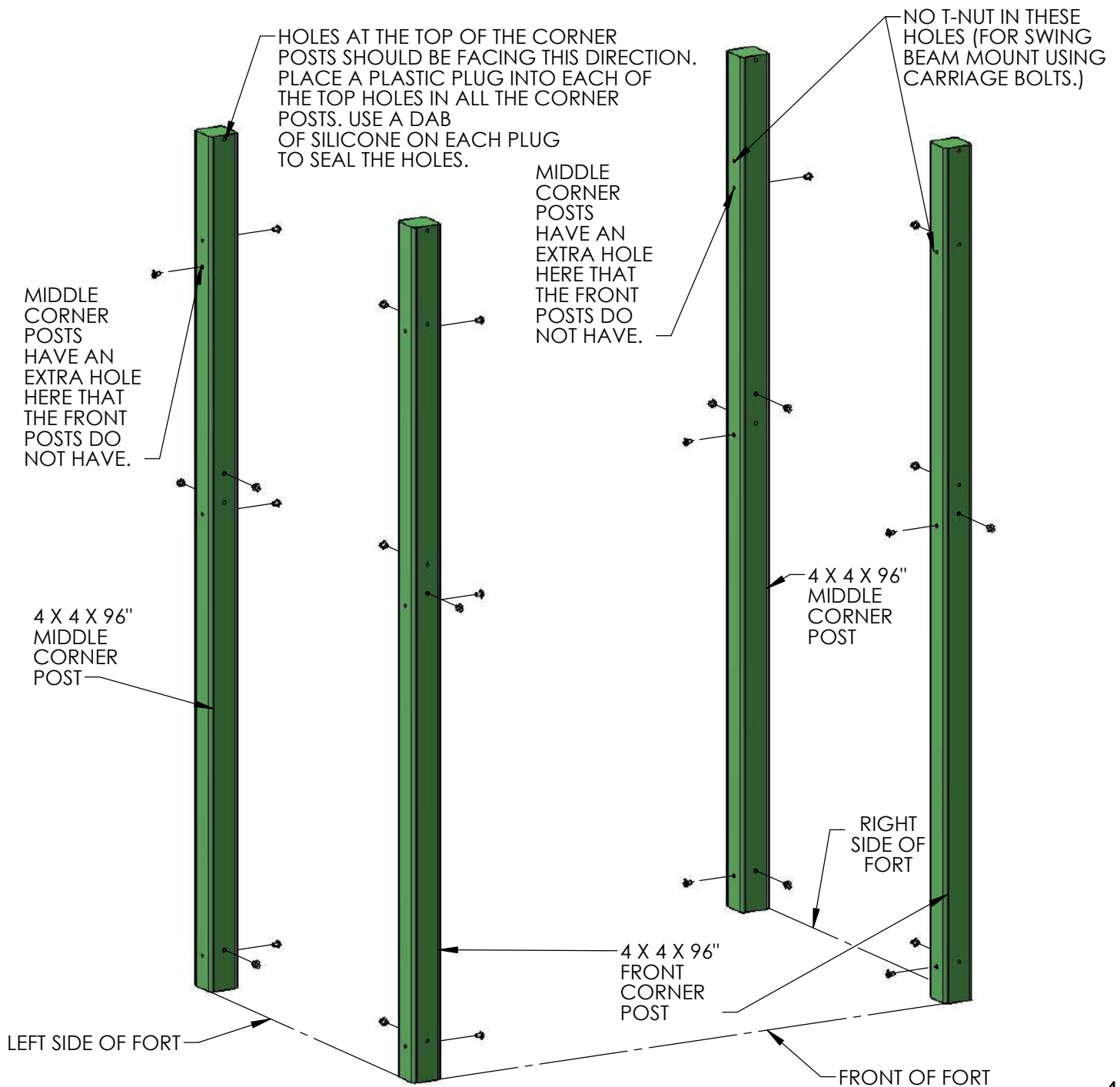

STEP 2: ASSEMBLING THE RIGHT SIDE FRAME

- 1: LAY THE RIGHT SIDE CORNER POSTS ON THE GROUND IN THEIR PROPER ORIENTATION.
- 2: LAY THE 2 X 6 X 78" SIDE SANDBOX BOARD- RIGHT ON TOP OF THE RIGHT SIDE CORNER POSTS AT THE BOTTOM OF THE CORNER POSTS. THE HOLES IN THE SIDE SANDBOX BOARD - RIGHT MUST BE OFFSET DOWN.
- 3: USE 5/16 X 4-1/2" HEX BOLTS AND 5/16" WASHERS TO ATTACH THE TOP HOLES OF THE SANDBOX BOARD TO THE T-NUTS INSTALLED ON THE CORNER POSTS. THE BOTTOM HOLES WILL BE USED LATER.
- 4: LAY THE 2 X 6 X 47-1/2" BOTTOM PANEL BOARD ON TOP OF THE RIGHT SIDE CORNER POSTS IN THE MIDDLE OF THE CORNER POSTS. THE HOLES IN THE BOTTOM PANEL BOARD MUST BE OFFSET DOWN.
- 5: USE 5/16 X 4-1/2" HEX BOLTS AND 5/16" WASHERS TO ATTACH THE BOTTOM HOLES OF THE BOTTOM PANEL BOARD TO THE T-NUTS INSTALLED ON THE CORNER POSTS. THE TOP HOLES WILL BE USED LATER.
- 6: LAY THE 4 X 4 X 47-1/2" SWING BEAM MOUNT ON TOP OF THE RIGHT SIDE CORNER POSTS. THE THREE COUNTERSUNK HOLES IN THE MIDDLE OF THE SWING BEAM MOUNT MUST FACE DOWNWARD.
- 7: FIND TWO TORQUE WASHERS. PLACE A 6-1/2" CARRIAGE BOLT THROUGH THE TORQUE WASHER, MAKING SURE THAT THE TEETH ARE FACING IN THE SAME DIRECTION AS THE THREADS OF THE CARRIAGE BOLT. PLACE THE TORQUE WASHER/CARRIAGE BOLT ASSEMBLY INTO THE CORNER POST HOLES SO THAT THE HEAD OF THE CARRIAGE BOLT FACES WHAT WILL BE THE INSIDE OF THE FORT. USE A HAMMER TO SET THE TORQUE WASHER INTO THE CORNER POST.
- 8: ATTACH THE SWING BEAM MOUNT AS SHOWN IN DETAIL A.

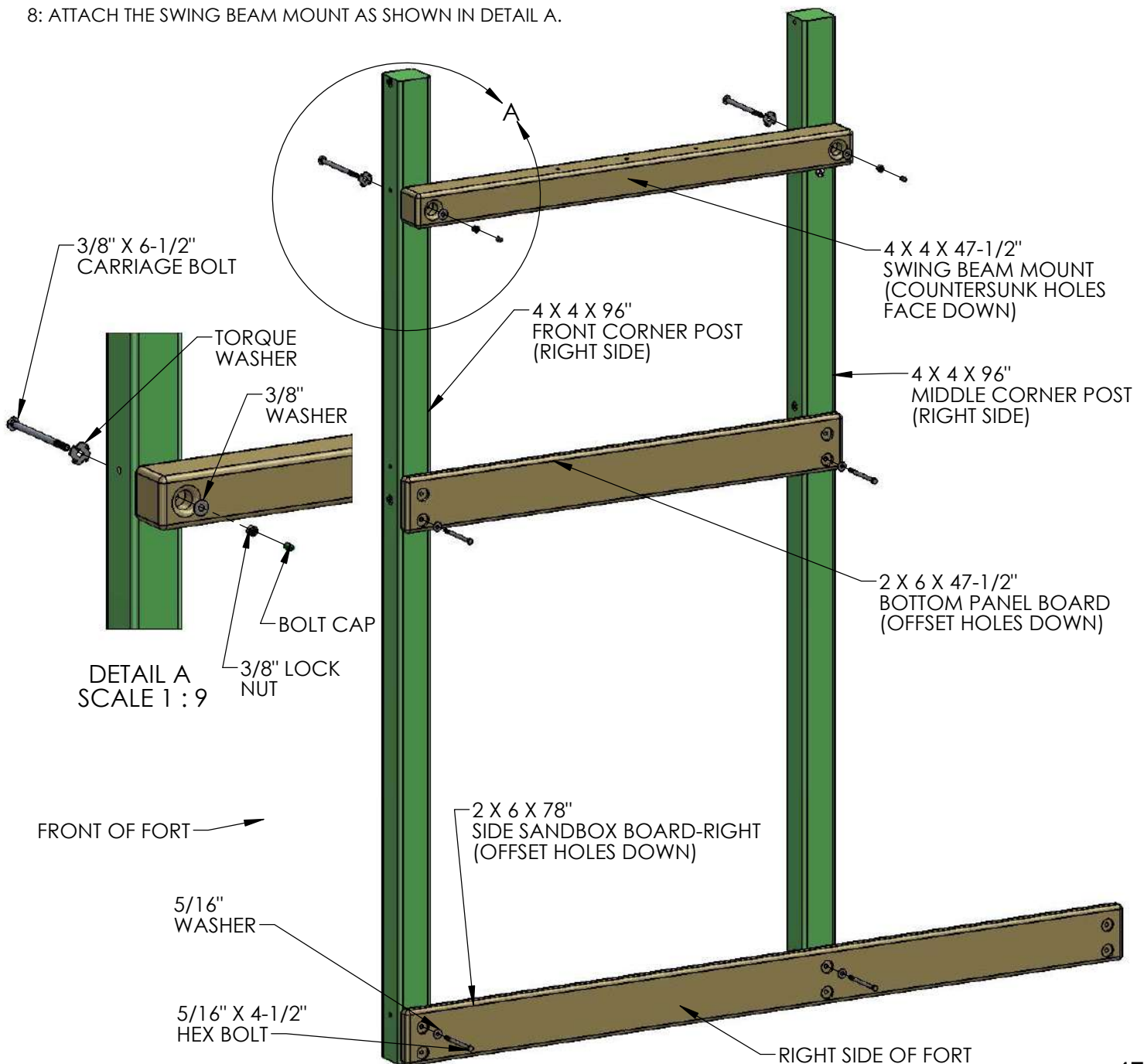

STEP 3: ASSEMBLING THE LEFT SIDE FRAME

- 1: LAY THE LEFT SIDE CORNER POSTS ON THE GROUND IN THEIR PROPER ORIENTATION.
- 2: LAY THE 2 X 6 X 78" SIDE SANDBOX BOARD - LEFT ON TOP OF THE LEFT SIDE CORNER POSTS AT THE BOTTOM OF THE CORNER POSTS. THE HOLES IN THE SIDE SANDBOX BOARD - LEFT MUST BE OFFSET DOWN.
- 3: USE 5/16 X 4-1/2" HEX BOLTS AND 5/16" WASHERS TO ATTACH THE TOP HOLES OF THE SIDE SANDBOX BOARD - LEFT TO THE T-NUTS INSTALLED ON THE CORNER POSTS. THE BOTTOM HOLES WILL BE USED LATER.
- 4: LAY THE 2 X 6 X 47-1/2" BOTTOM PANEL BOARD ON TOP OF THE LEFT SIDE CORNER POSTS IN THE MIDDLE OF THE CORNER POSTS. THE HOLES IN THE BOTTOM PANEL BOARD MUST BE OFFSET DOWN.
- 5: USE 5/16 X 4-1/2" HEX BOLTS AND 5/16" WASHERS TO ATTACH THE BOTTOM HOLES OF THE BOTTOM PANEL BOARD TO THE T-NUTS INSTALLED ON THE CORNER POSTS. THE TOP HOLES WILL BE USED LATER.
- 6: LAY THE 2 X 6 X 47-1/2" TOP PANEL BOARD ON TOP OF THE LEFT SIDE CORNER POSTS. THE HOLES IN THE TOP PANEL BOARD MUST BE OFFSET DOWN.
- 7: USE 5/16 X 4-1/2" HEX BOLTS AND 5/16" WASHERS TO ATTACH THE TOP HOLES OF THE TOP PANEL BOARD TO THE T-NUTS INSTALLED ON THE CORNER POSTS. THE BOTTOM HOLES WILL BE USED LATER.

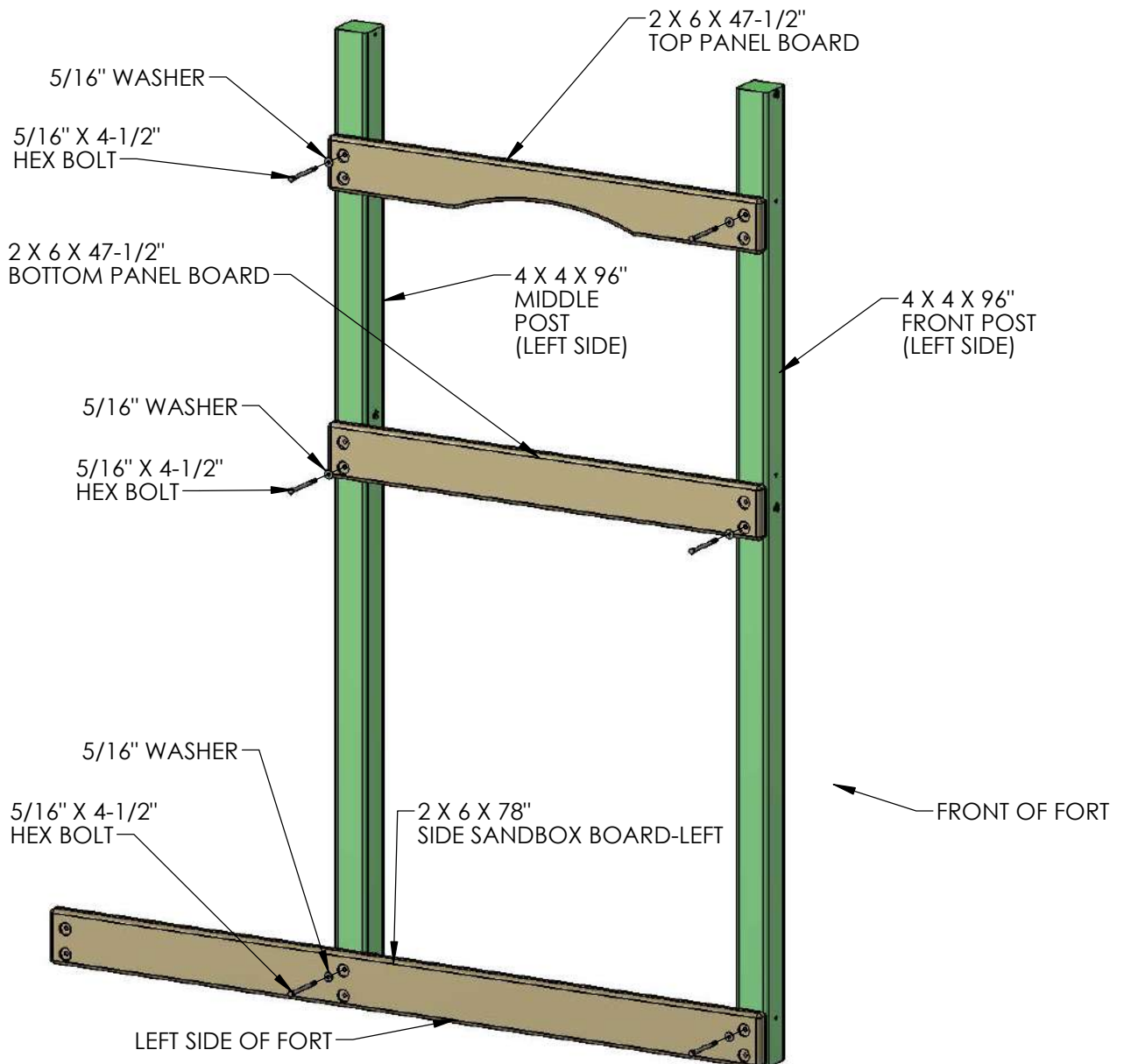

STEP 4: DRILL HOLES FOR BRIDGE CHAINS

1: 1: LOCATE ONE 2 X 4 X 70" DECK SUPPORT AND ONE 2 X 6 X 70" FRONT FACE BOARD.

2: MEASURE AS SHOWN BELOW AND MAKE MARKS ON EACH BOARD.

3: PLACE A SCRAP PIECE OF WOOD UNDER THE BOARD BEFORE YOU DRILL THE 1" HOLES WITH A SPADE BIT.

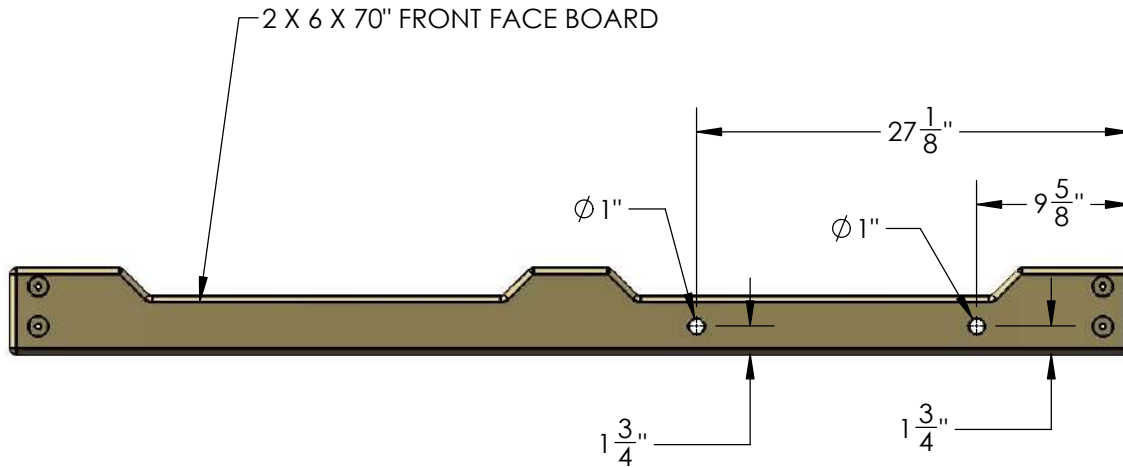
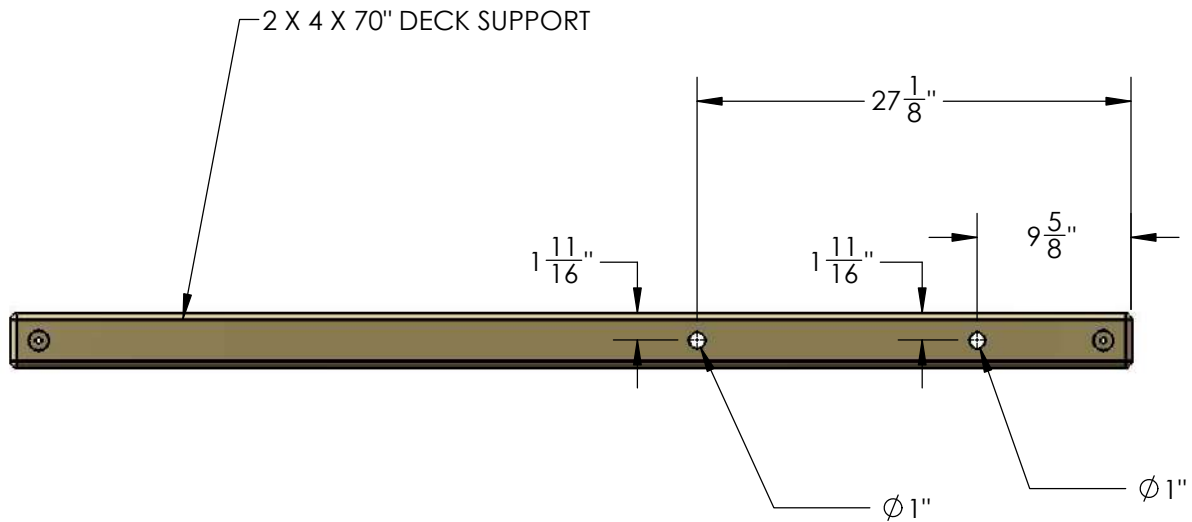

STEP 5: DECK SUPPORTS

YOU WILL NEED AN EXTRA PERSON FOR THIS STEP.

1: WITH HELP, STAND UP THE LEFT AND RIGHT SIDE ASSEMBLIES.

2: FASTEN THE 2 X 4 X 70" DECK SUPPORTS TO THE HOLES AT 54-3/4" WITH 5/16 X 4-1/2" HEX BOLTS AND 5/16" WASHERS FROM THE INSIDE OF THE FORT

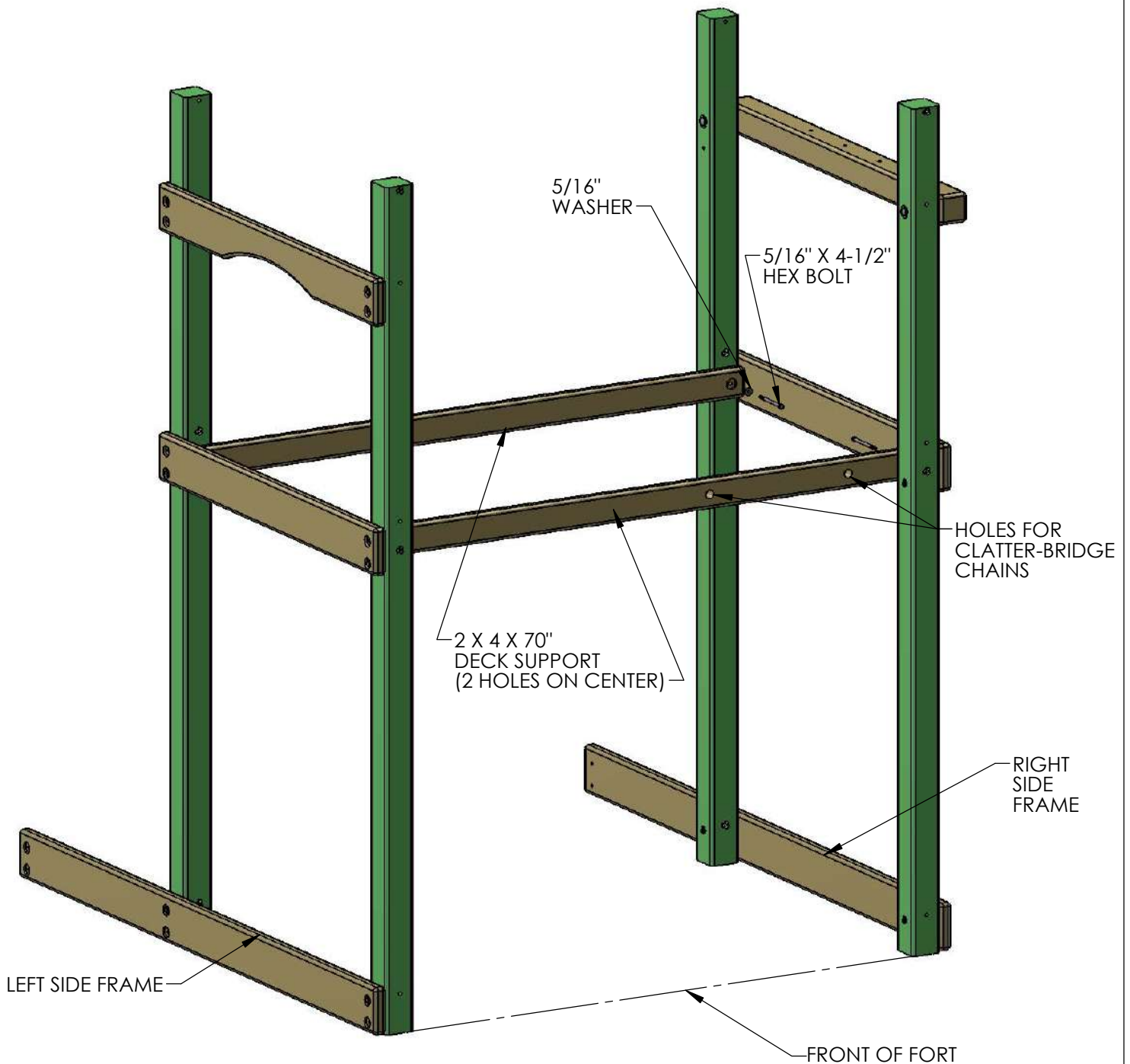

STEP 6: FRONT FRAME ASSEMBLY

1: PLACE THE 2 X 6 X 102" ROPE LADDER RUNNER ON THE FRONT OF THE CORNER POSTS. THE HOLES IN THE ROPE LADDER RUNNER SHOULD BE OFFSET UP.

2: USE 5/16 X 4-1/2" HEX BOLTS AND 5/16" WASHERS TO ATTACH THE TOP HOLES OF THE ROPE LADDER RUNNER TO THE T-NUTS INSTALLED IN THE CORNER POSTS. THE BOTTOM HOLES WILL BE USED LATER.

3: PLACE THE 2 X 6 X 70" FRONT FACE BOARD WITH NOTCHES ON THE FRONT OF THE CORNER POSTS. THE HOLES IN THE FRONT FACE BOARD SHOULD BE OFFSET UP.

4: USE 5/16 X 4-1/2" HEX BOLTS AND 5/16" WASHERS TO ATTACH THE TOP HOLES OF THE FRONT FACE BOARD TO THE T-NUTS INSTALLED IN THE CORNER POSTS. THE BOTTOM HOLES WILL BE USED LATER.

5: PLACE THE 2 X 6 X 102" ROPE LADDER SUPPORT ON THE FRONT OF THE CORNER POSTS. THE HOLES IN THE ROPE LADDER SUPPORT SHOULD BE OFFSET UP.

6: USE 5/16 X 4-1/2" HEX BOLTS AND 5/16" WASHERS TO ATTACH THE TOP HOLES OF THE ROPE LADDER SUPPORT TO THE T-NUTS INSTALLED IN THE CORNER POSTS.

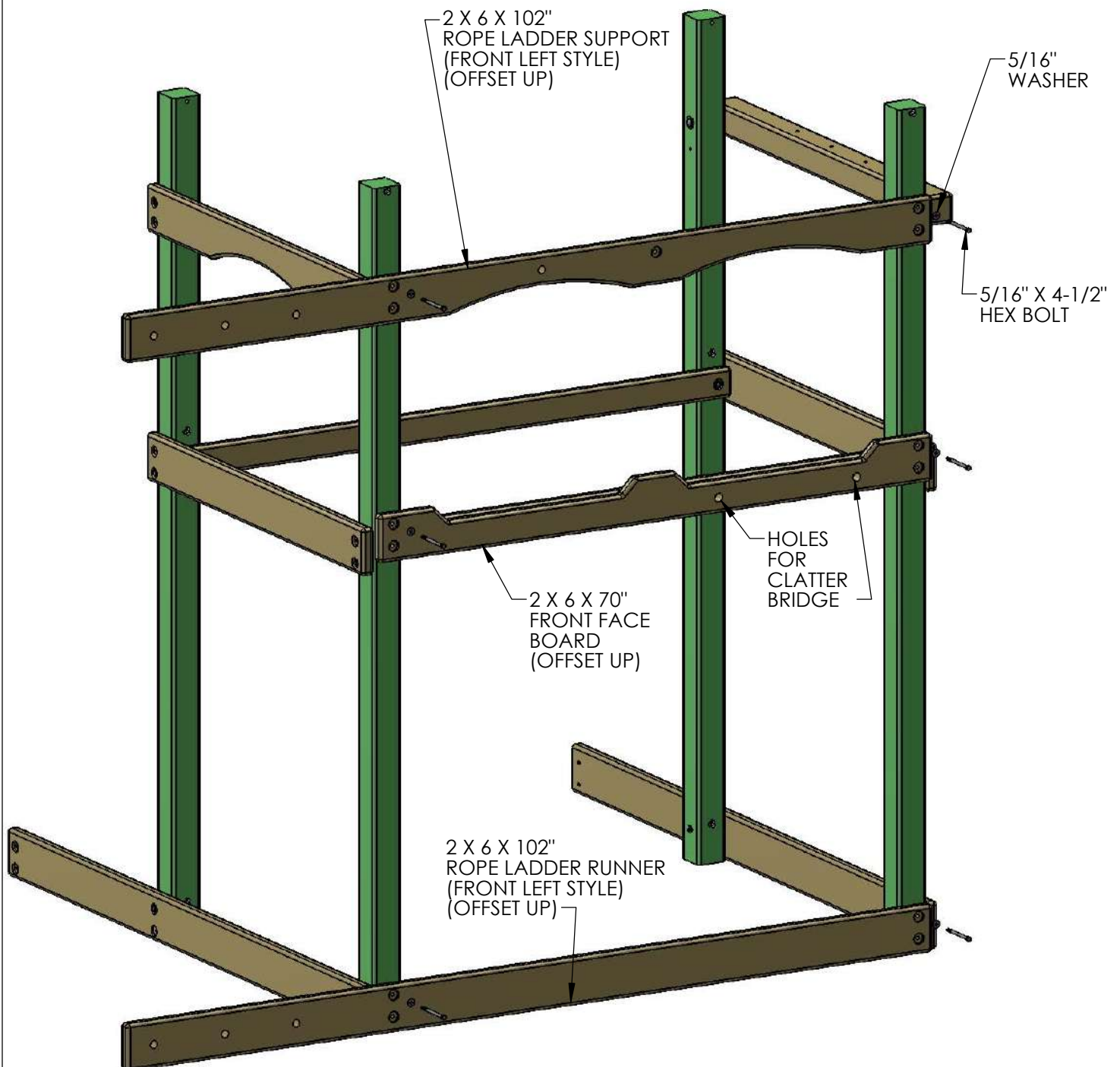

STEP 7: REAR FRAME ASSEMBLY

- 1: PLACE THE 2 X 6 X 70" SANDBOX BOARD ON THE BOTTOM REAR OF THE CORNER POSTS. THE HOLES IN THE SANDBOX BOARD MUST BE OFFSET UP.
- 2: USE 5/16 X 4-1/2" HEX BOLTS AND 5/16" WASHERS TO ATTACH THE TOP HOLES OF THE SANDBOX BOARD TO THE T-NUTS INSTALLED IN THE CORNER POSTS. THE BOTTOM HOLES WILL BE USED LATER.
- 3: PLACE THE 2 X 6 X 70" BACK PANEL BOARD AT THE MIDDLE OF THE REAR CORNER POSTS. THE HOLES IN THE BACK PANEL BOARD MUST BE OFFSET DOWN.
- 4: USE 5/16 X 4-1/2" HEX BOLTS AND 5/16" WASHERS TO ATTACH THE TOP HOLES OF THE BACK PANEL BOARD TO THE T-NUTS INSTALLED IN THE CORNER POSTS. THE BOTTOM HOLES WILL BE USED LATER.

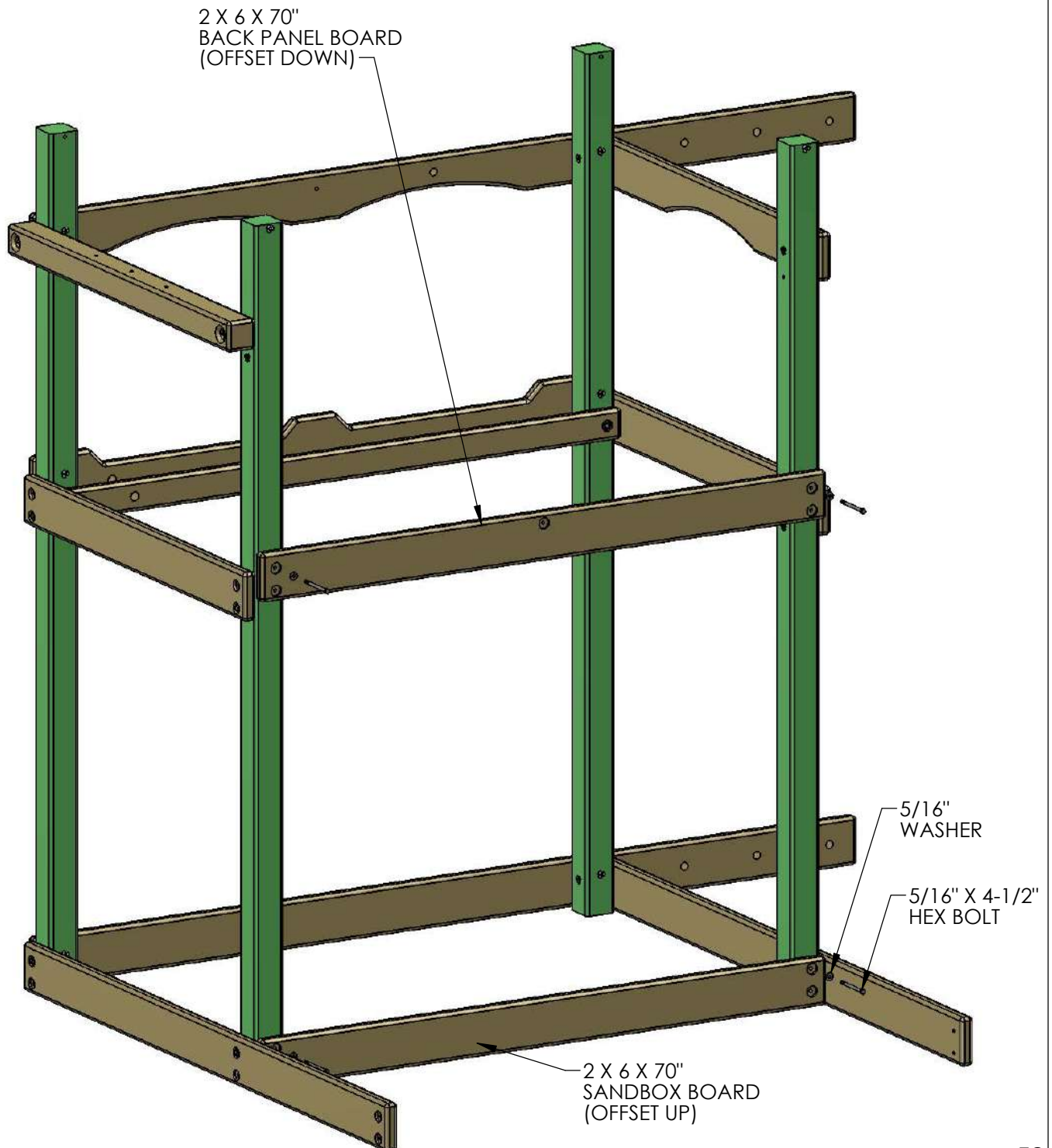

STEP 8: LEVELING THE PLAY SET AND LAGS

1: INSTALL LAG SCREWS ONLY IN THE FOUR 2 X 6 BOARDS AT DECK HEIGHT AT THIS TIME. SQUARE EACH OF THESE FOUR BOARDS TO THE CORNER POSTS AND THEN INSTALL THE LAG SCREWS. THIS IS TO MAKE THE STRUCTURE RIDGID FOR THE LEVELING AND SQUARING PROCESS.

2: PLACE THE FRAME IN ITS FINAL POSITION AND FOLLOW THE PROCEDURES AT THE FRONT OF THE MANUAL TO LEVEL AND SQUARE THE STRUCTURE. HAVE AN ASSISTANT HELP YOU LIFT THE FRAME AS REQUIRED. **DO NOT** INSTALL REMAINING LAG SCREWS UNTIL AFTER THE FRAME HAS BEEN LEVELED AND SQUARED.

3: ONCE THE FRAME IS LEVEL, SQUARE AND SET INTO POSITION; GO BACK AND INSERT THE 5/16" X 3-1/2" LAG SCREWS AND 5/16" WASHERS IN ALL OF THE REMAINING HOLES OF THE 2 X 6 PARTS ON THE FRONT, SIDES AND REAR OF THE PLAY SET. NOTE: THERE WILL NOT BE ANY PREDRILLED HOLES IN THE CORNER POSTS FOR THE LAG SCREWS.

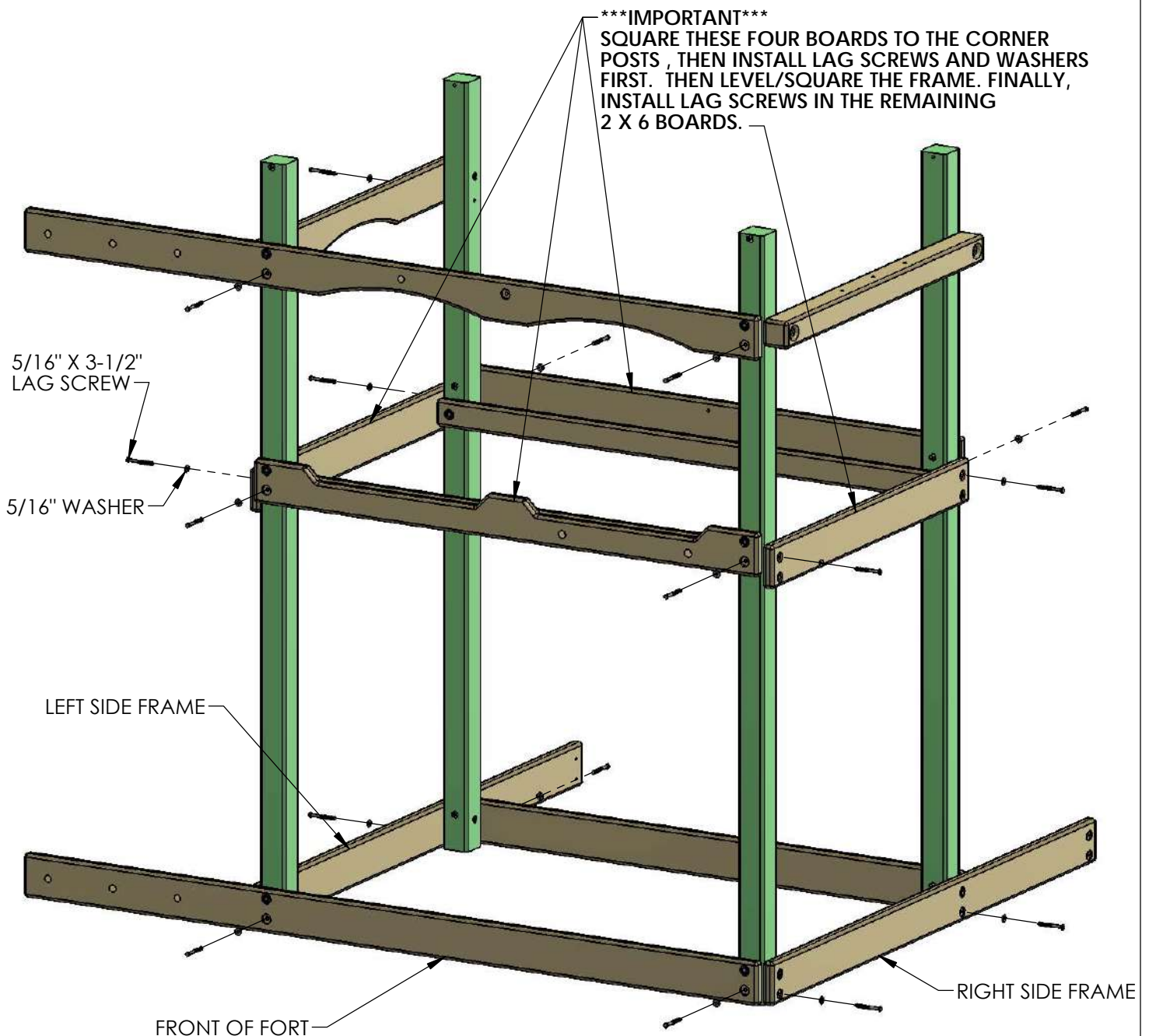

STEP 9: ANGLE SUPPORTS

1: FOUR 2 X 4 X 13" ANGLE SUPPORTS ARE MOUNTED UNDER THE DECK ON THE LEFT AND RIGHT SIDES OF THE PLAY SET TO THE 2 X 6 BOTTOM PANEL BOARDS. **THE TOP OF THE ANGLE SUPPORT SHOULD BE FLUSH OR LOWER THAN THE TOP OF THE DECK SUPPORT.**

2: AT THE TOP USE 2-1/2" WOOD SCREWS THROUGH THE DECK SUPPORT INTO THE ANGLE SUPPORT. AT THE BOTTOM USE ONE 2" AND ONE 3" WOOD SCREW TO FASTEN THE ANGLE SUPPORT TO THE CORNER POST.

3: FOUR 2 X 4 X 18" ANGLE SUPPORTS ARE MOUNTED UNDER THE DECK ON THE FRONT AND REAR OF THE PLAY SET TO THE 2 X 4 DECK SUPPORTS. **THE TOP OF THE ANGLE SUPPORT SHOULD BE FLUSH OR LOWER THAN THE TOP OF THE DECK SUPPORT.**

4: AT THE TOP USE TWO 2-1/2" WOOD SCREWS THROUGH THE DECK SUPPORT INTO THE ANGLE SUPPORT. AT THE BOTTOM USE ONE 2" AND ONE 3" WOOD SCREW TO FASTEN THE ANGLE SUPPORT TO THE CORNER POST.

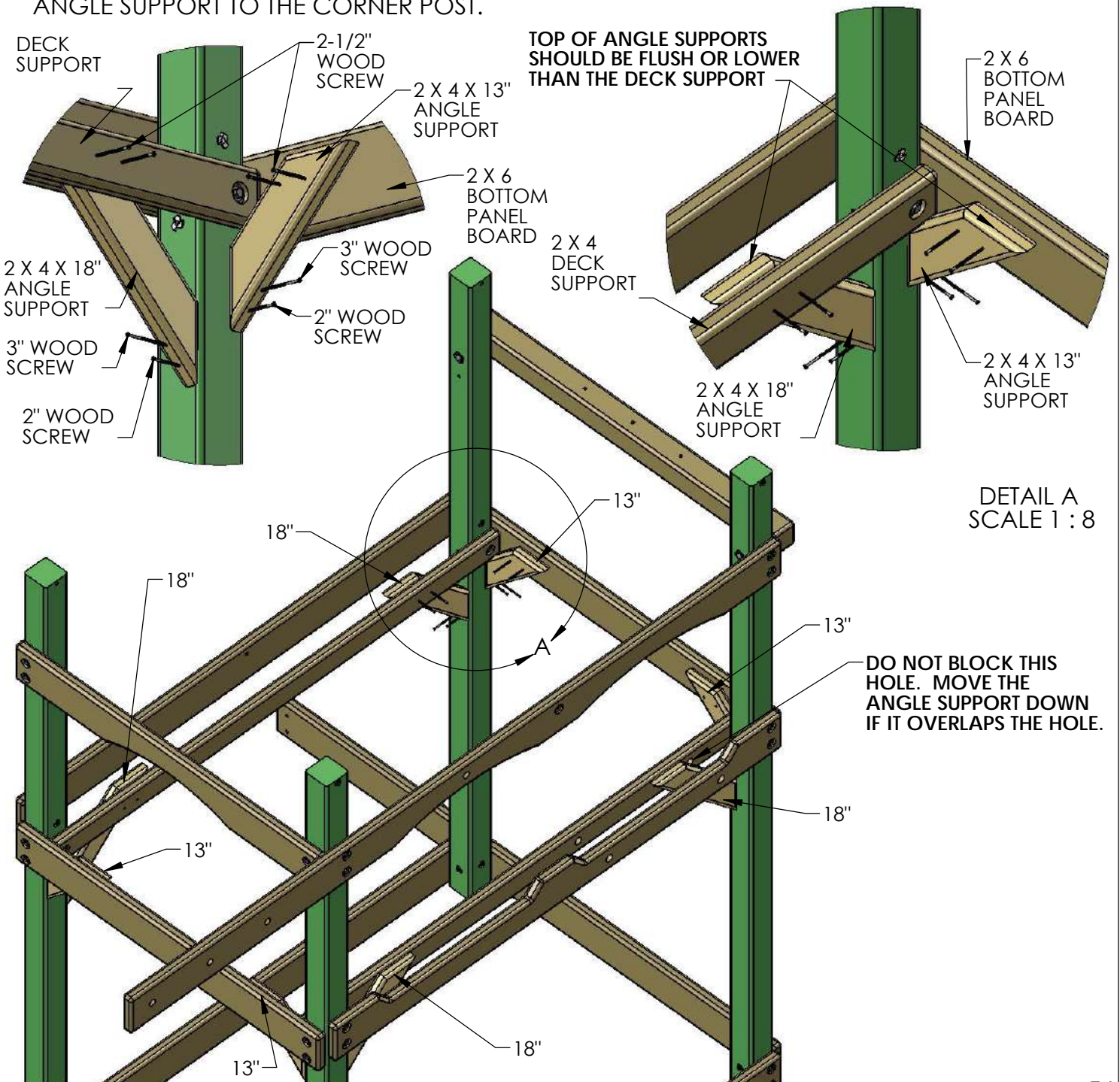

DETAIL A
SCALE 1 : 8

STEP 10: BOTTOM PANEL BOARDS

1: PLACE THE 2 X 4 X 14" BOTTOM PANEL BOARD ON TOP OF THE 2 X 6 PANEL BOARD AND FASTEN TO THE CORNER POSTS WITH 5/16" X 3-1/2" LAG SCREWS WITH 5/16" WASHERS.

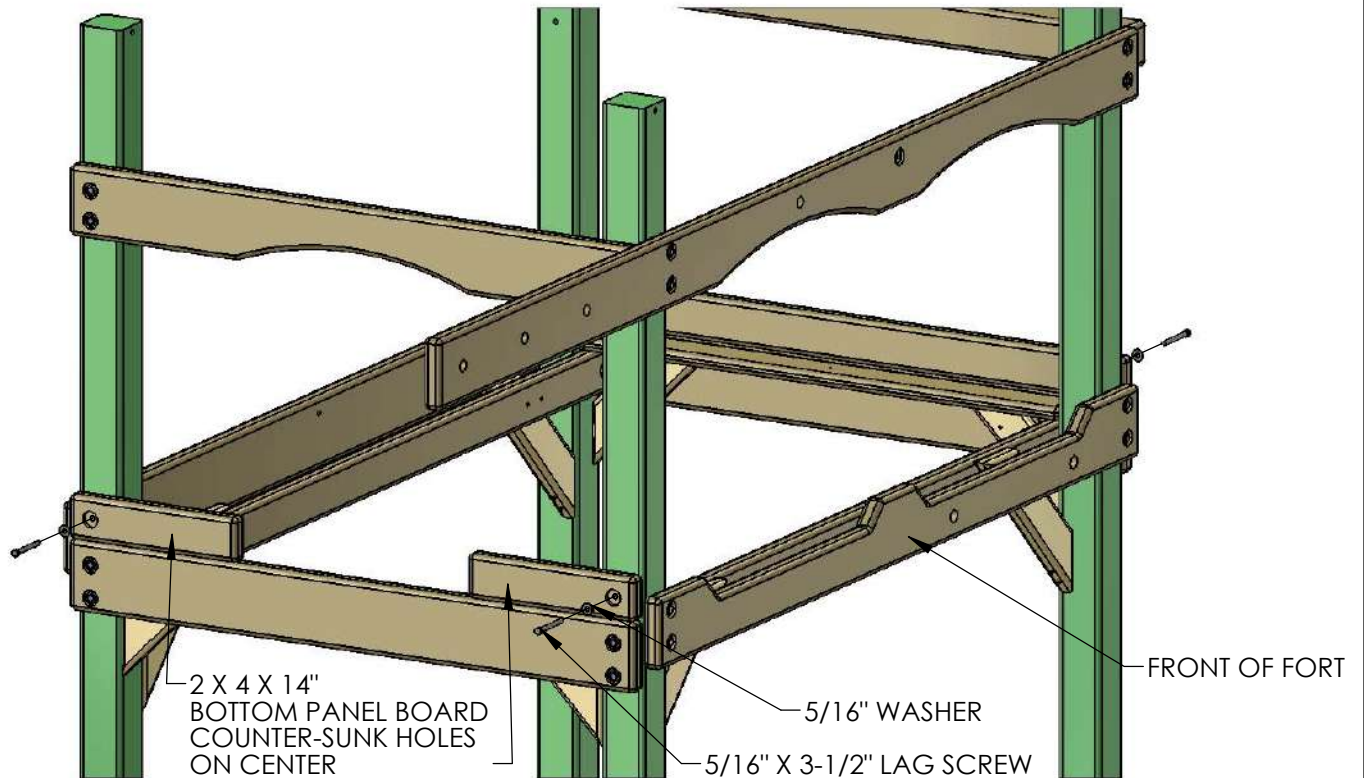

2: PLACE THE 2 X 4 X 47-1/2" BOTTOM PANEL BOARD ON TOP OF THE 2 X 6 PANEL BOARD WITH OFFSET HOLES UP AND FASTEN TO THE CORNER POSTS WITH 5/16" X 3-1/2" LAG SCREWS AND 5/16" WASHERS.

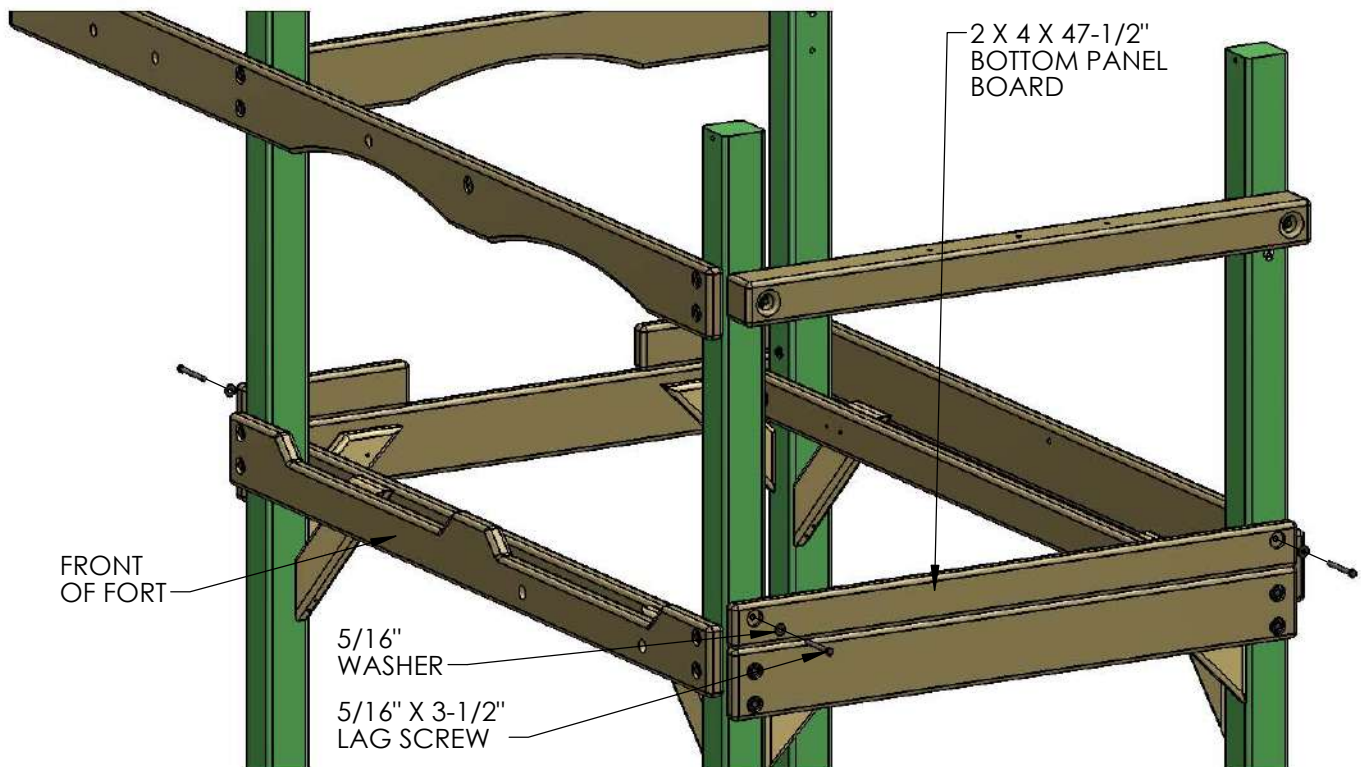

STEP 11: DECK SPACERS

THE FOLLOWING STEP IS RECOMMENDED TO PREVENT POSSIBLE SPLITS IN THE WOOD.

1: PRE-DRILL THE ENDS OF THE 5/4 X 4 X 40-3/8" DECK SPACERS TO PREVENT INSTALLATION DAMAGE. PRE-DRILL BOTH ENDS WITH A 1/8" DRILL BIT AT THE DIMENSIONS SHOWN BELOW. THE HOLE AT 20-3/16" ONLY NEEDS TO BE DRILLED ONCE. THIS HOLE IS TO ATTACH THE CENTER DECK SUPPORT TO THE DECK SPACER.

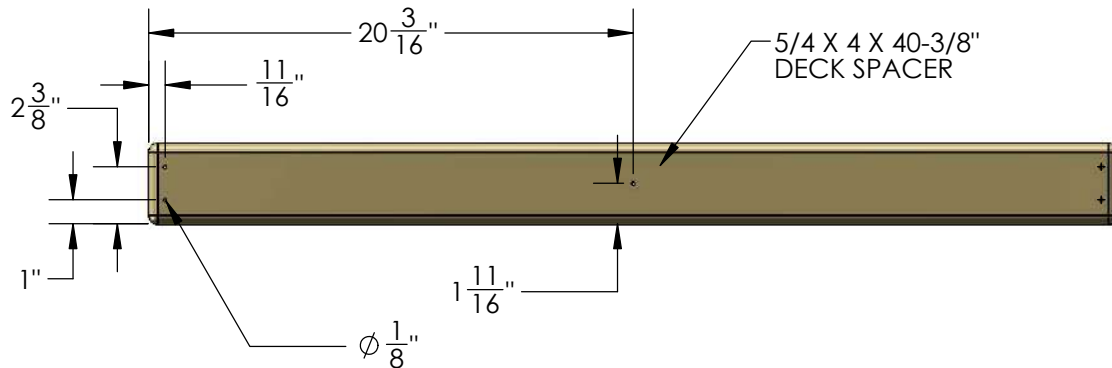

2: PLACE THE 5/4 X 4 X 40-3/8" DECK SPACER AT ONE END OF THE FORT. CENTER THE BOARD BETWEEN THE CORNER POSTS AND ATTACH IT WITH 2" WOOD SCREWS THROUGH THE PREDRILLED HOLES INTO THE DECK SUPPORT BELOW. NOTE THE TOP OF THE SCREW HEAD SHOULD BE FLUSH TO THE TOP OF THE DECK SPACER.

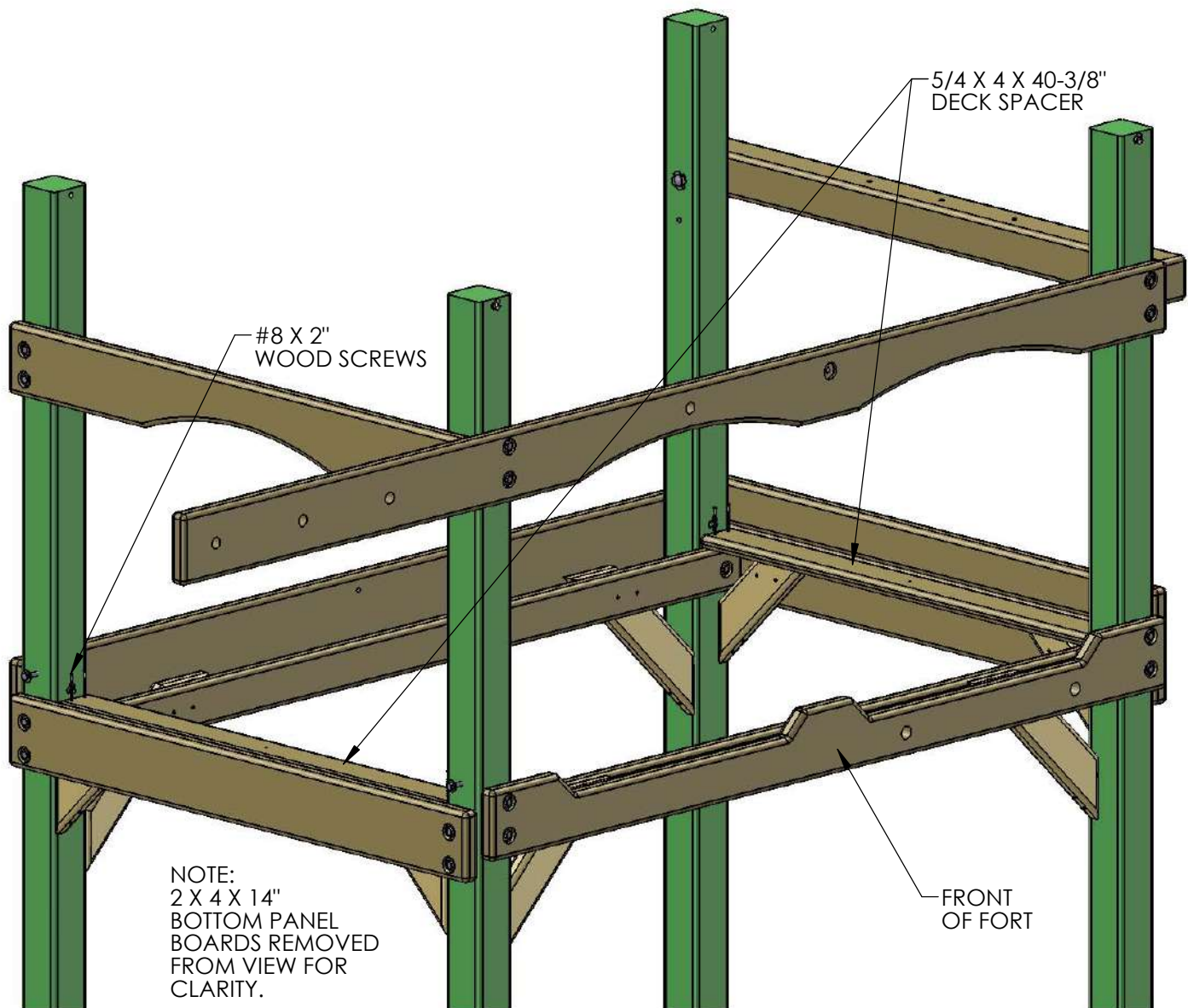

STEP 12: CENTER DECK SUPPORT

1: FIND THE 2 X 4 X 70" CENTER DECK SUPPORT WITHOUT HOLES.

2: FROM THE UNDERSIDE OF THE DECK SPACERS THAT WERE PREVIOUSLY INSTALLED, PLACE THE CENTER DECK SUPPORT AT THE CENTER OF THE DECK SPACERS (USE THE HOLE ON CENTER AS A GUIDE) AND DRAW A LINE ON THE OUTSIDE OF THE FORT TO REPRESENT A CENTER LINE.

3: CENTER THE 2 X 4 X 70" CENTER DECK SUPPORT ON THE LINE AND PUSH THE CENTER DECK SUPPORT FLUSH TO THE BOTTOM SIDE OF THE DECK SPACERS. USE 2" WOOD SCREWS TO ATTACH THE DECK SPACERS TO THE CENTER DECK SUPPORT.

4: USING TWO 2-1/2" WOOD SCREWS, ATTACH THE 2 X 4 X 70" CENTER DECK SUPPORT THROUGH THE OUTSIDE OF THE 2 X 6, AND INTO THE END OF THE CENTER DECK SUPPORT. REPEAT THIS STEP ON THE OPPOSITE END OF THE FORT.

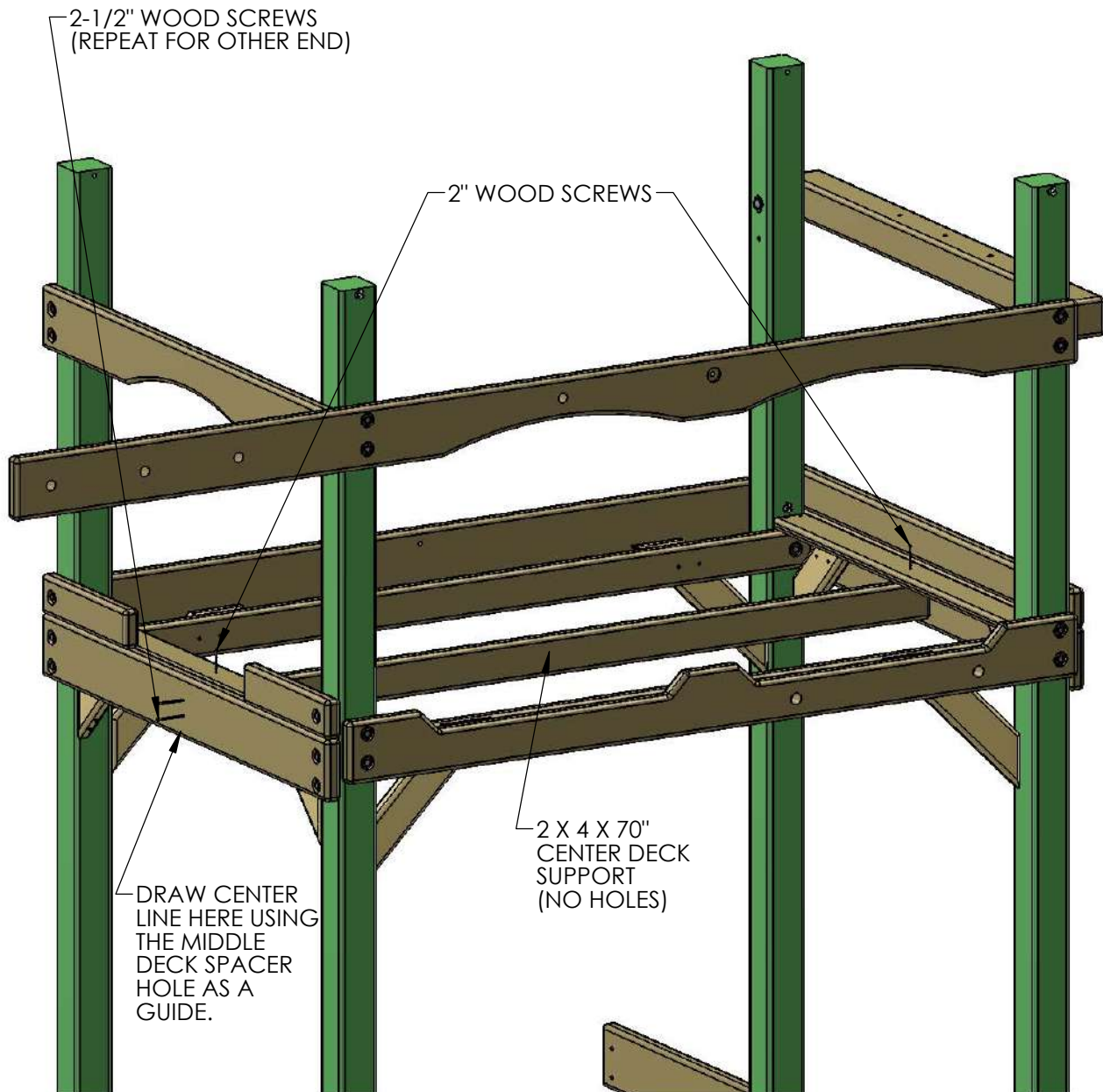

STEP 13: DECK BOARDS

THE FOLLOWING STEP IS RECOMMENDED TO PREVENT POSSIBLE SPLITS IN THE WOOD

1: PRE-DRILL THE ENDS OF THE DECK BOARDS TO PREVENT INSTALLATION DAMAGE. PRE-DRILL BOTH ENDS WITH A 1/8" DRILL BIT AT THE DIMENSIONS SHOWN BELOW.

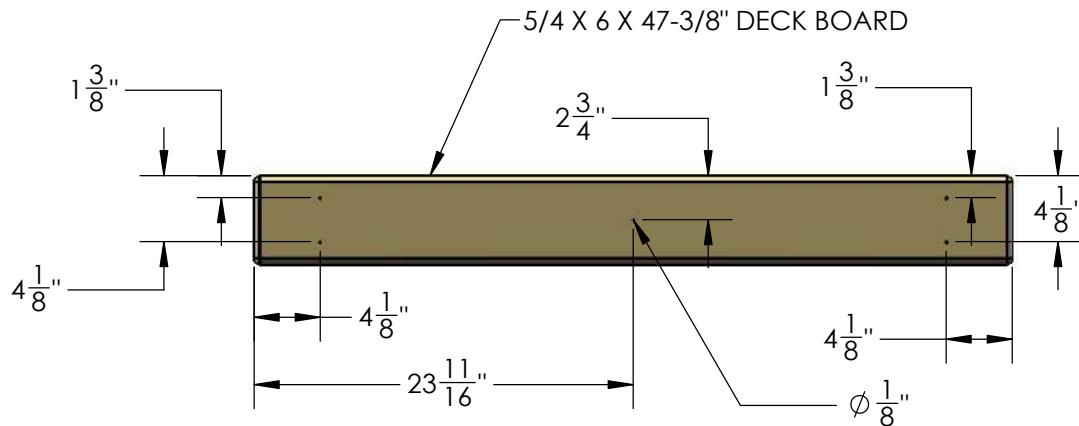

2: START WITH A 5/4 X 6 X 47-3/8" DECK BOARD AT ONE END OF THE FORT. CENTER THE BOARD BETWEEN THE FRONT FACE BOARD AND THE REAR BOTTOM PANEL BOARD AND ATTACH IT WITH 2" WOOD SCREWS THROUGH THE PREDRILED HOLES AND INTO THE DECK SUPPORTS BELOW. LEAVE A UNIFORM (APPROX. 1/4") SPACE BETWEEN THE DECK BOARDS. NOTE: THE TOP OF THE SCREW HEAD SHOULD BE FLUSH TO THE TOP OF THE DECK BOARDS.

LAY ALL DECK BOARDS ACROSS THE DECK SUPPORTS BEFORE SECURING THEM TO THE FORT. THIS WILL ENSURE THAT YOU HAVE EQUAL SPACING ACROSS THE DECK.

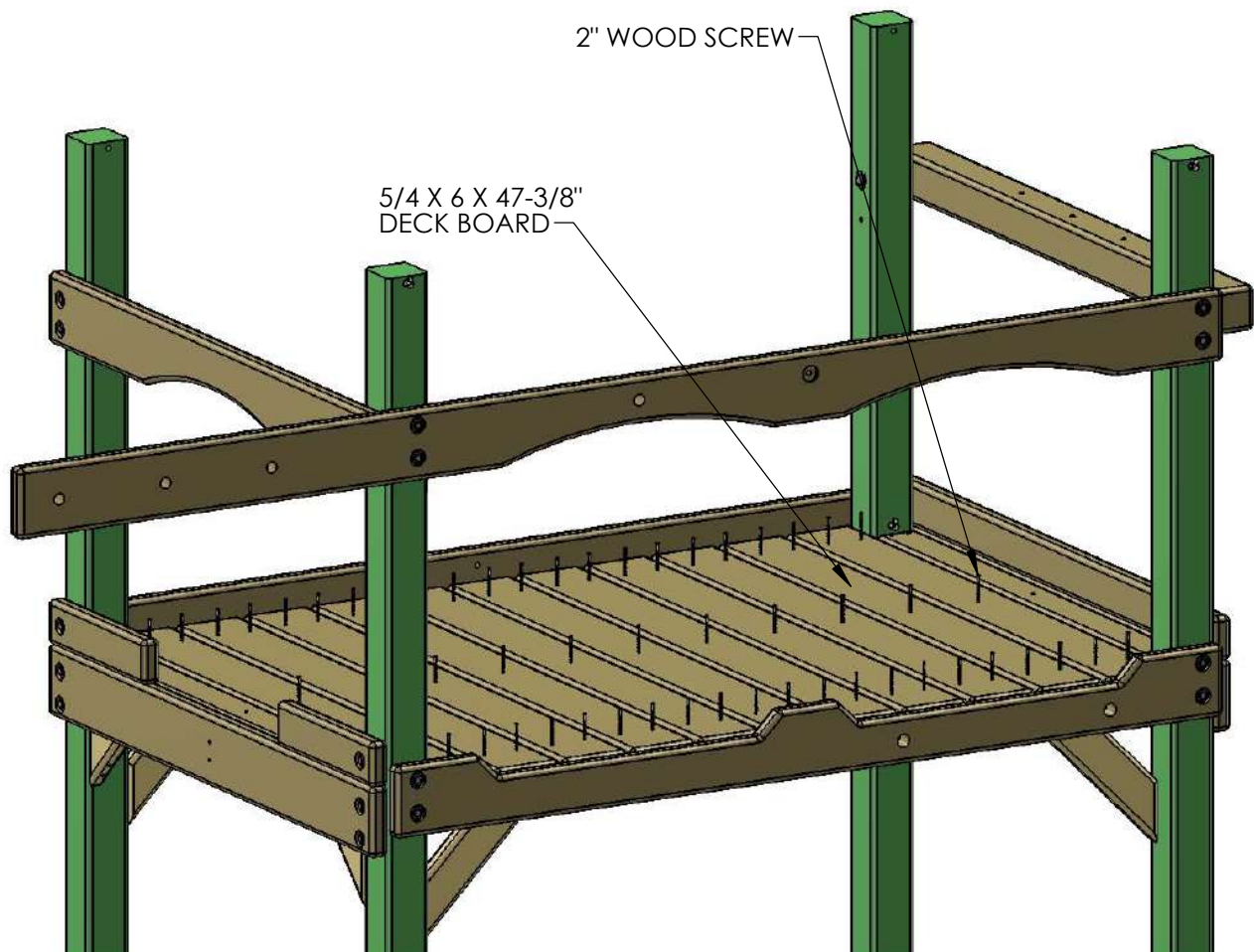

STEP 14: ROCK WALL

- 1: FIND TWO 2 X 4 X 66" ROCK WALL SIDES.
- 2: POSITION THE ROCK WALL SIDES SO THAT THE HOLES IN THE BOARDS ARE BOTH FACING THE SAME WAY.
- 3: INSERT T-NUTS INTO THE INSIDE OF THE ROCK WALL SIDES AND SET WITH A HAMMER.

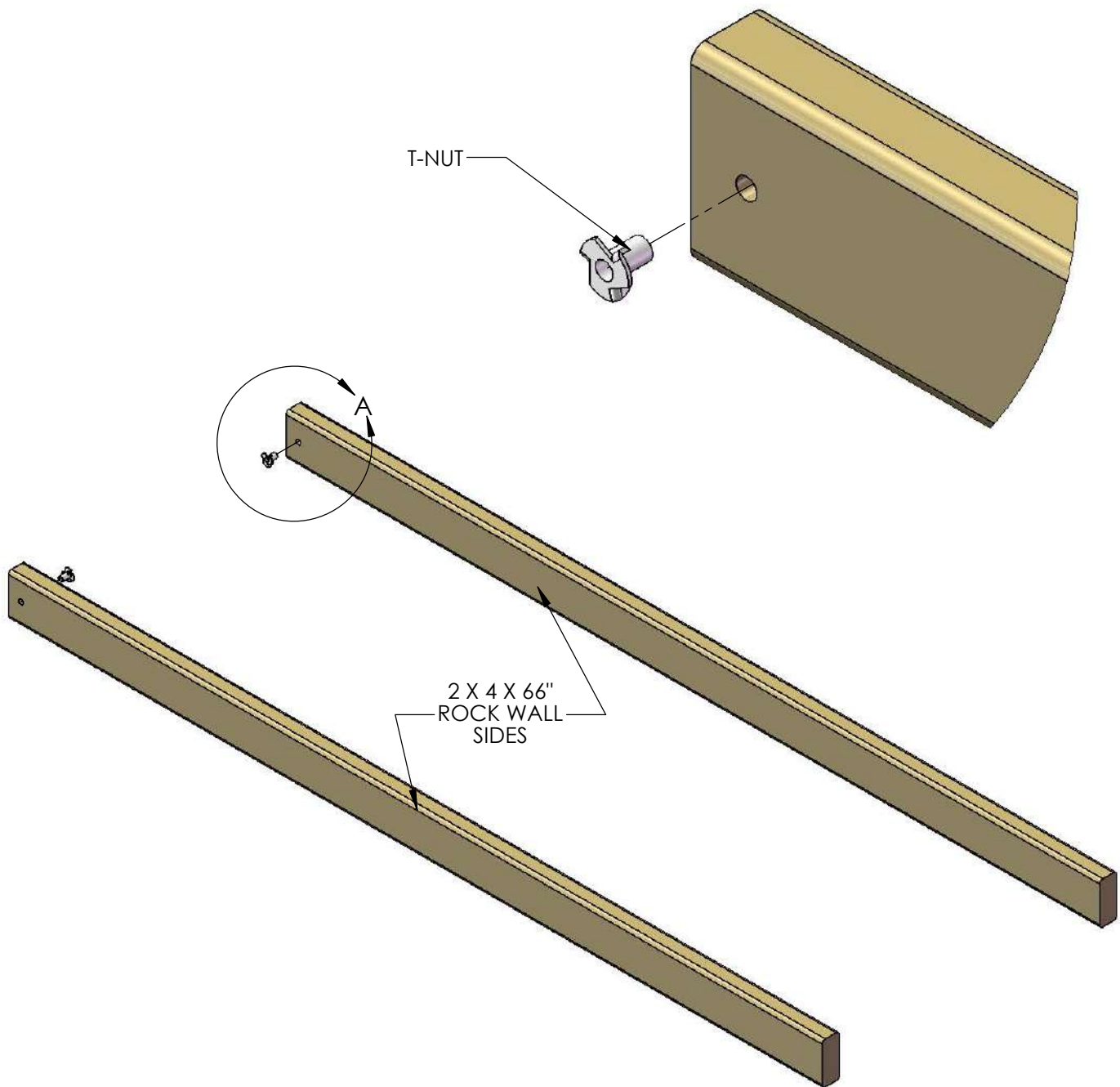

STEP 15: ROCK WALL

- 1: FIND ELEVEN 5/4 X 6 X 23-7/8" ROCK WALL BOARDS, AND ONE 5/4 X 6 X 23-7/8" BOTTOM ROCK WALL BOARD (1 HOLE).
- 2: STARTING FROM THE TOP, PLACE ONE ROCK WALL BOARD ON TOP OF THE ROCK WALL SIDES, FLUSH TO THE TOP OF THE ROCK WALL SIDES, AND ATTACH WITH TWO 2" WOOD SCREWS IN EACH SIDE.
- 3: CONTINUE DOWN THE ROCK WALL WITH THE REMAINING ROCK WALL BOARDS, FASTENING EACH BOARD WITH TWO 2" WOOD SCREWS ON EACH END.
- 4: THE FINAL BOARD WILL BE THE BOTTOM ROCK WALL BOARD WITH ONE HOLE. ATTACH WITH TWO 2" WOOD SCREWS PER SIDE.
- 5: IN SOME CASES, THERE WILL BE EXCESS LENGTH ON THE ROCK WALL SIDES. THIS IS DUE TO MILLING VARIATIONS, AND IS ALSO USED TO HELP LEVEL THE ROCK WALL SIDES ON UNEVEN GROUND.
- 6: ROCK WALL SIDES MAY NOT BE EVEN WITH THE BOTTOM ROCK WALL BOARD DUE TO MILLING VARIATIONS AND WOOD SHRINKAGE.

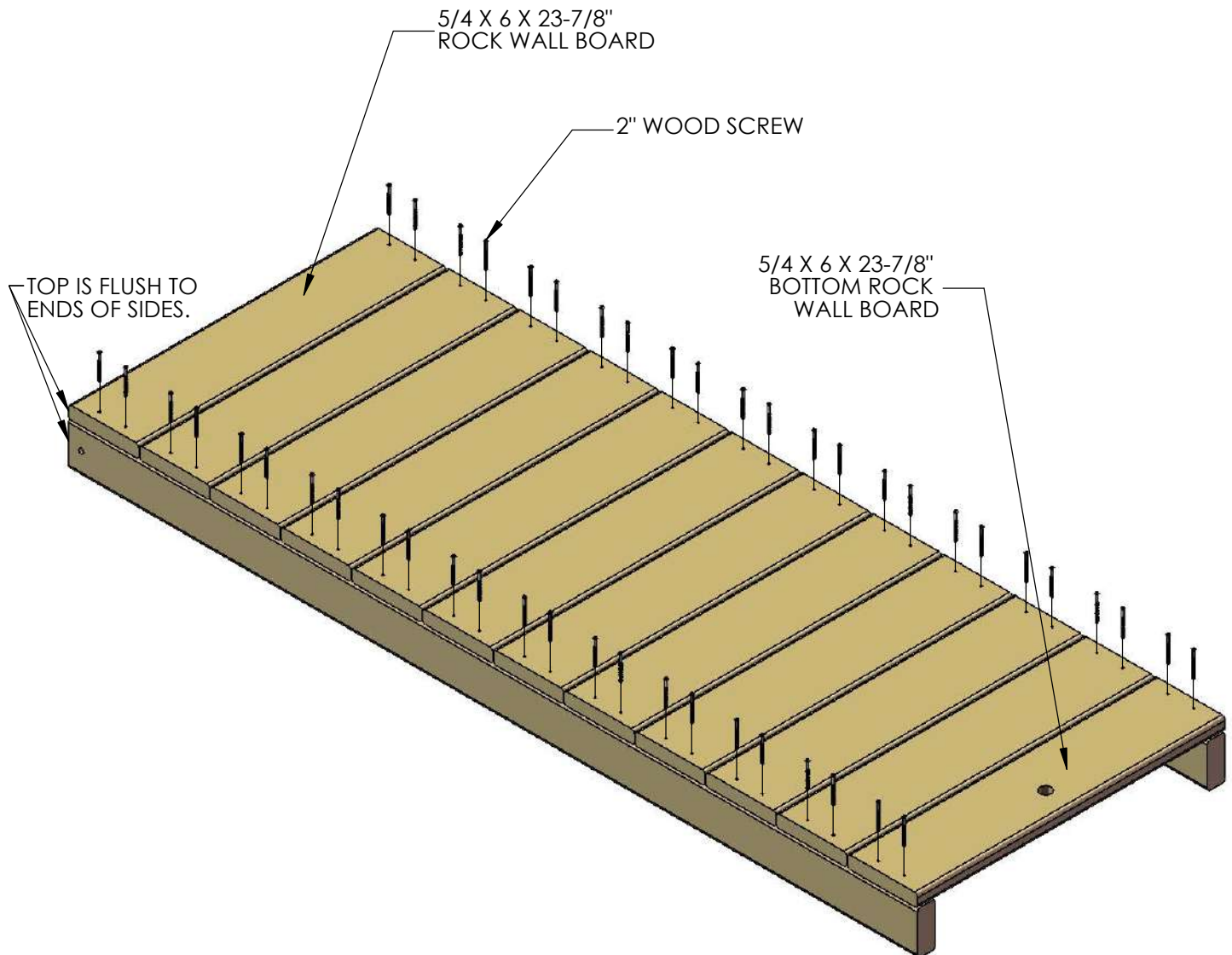

STEP 16: ROCK WALL

1: FASTEN THE 90° GREEN BRACKET TO THE ROCK WALL SIDES WITH 5/16" X 1-1/2" HEX BOLTS AND 5/16" WASHERS.

2: DO NOT FULLY TIGHTEN THE HEX BOLTS INTO THE T-NUTS AT THIS TIME.

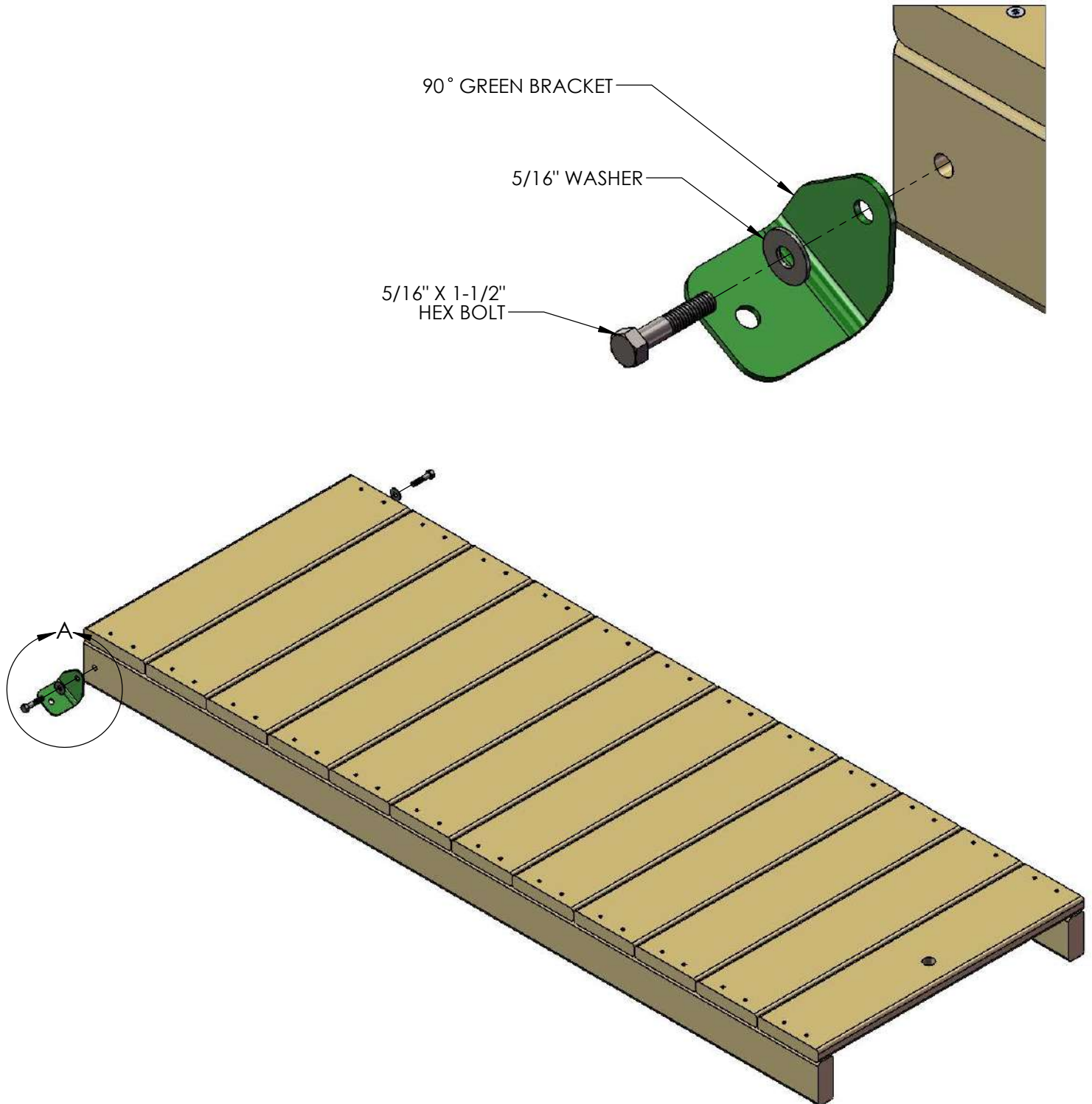

STEP 17: ROCK WALL

1: FIND TEN ROCKS AND THIRTY 1-1/4" PAN HEAD SCREWS WITH WASHERS.

2: MOUNT THE ROCKS IN A STAGGERED MANNER ON THE ROCK WALL BOARDS. THREE PAN HEAD SCREWS AND WASHERS WILL SECURE EACH ROCK TO THE WALL.

NOTE: THE IMAGE SHOWN BELOW IS A GENERIC ARRANGEMENT OF ROCKS ON THE ROCK WALL. YOUR ACTUAL CONFIGURATION MAY BE DIFFERENT THAT WHAT YOU SEE BELOW. ROCKS CAN BE ARRANGED IN ANY PATTERN AS LONG AS THEY WILL ALLOW PROPER ACCESS TO THE FORT. BE CREATIVE!

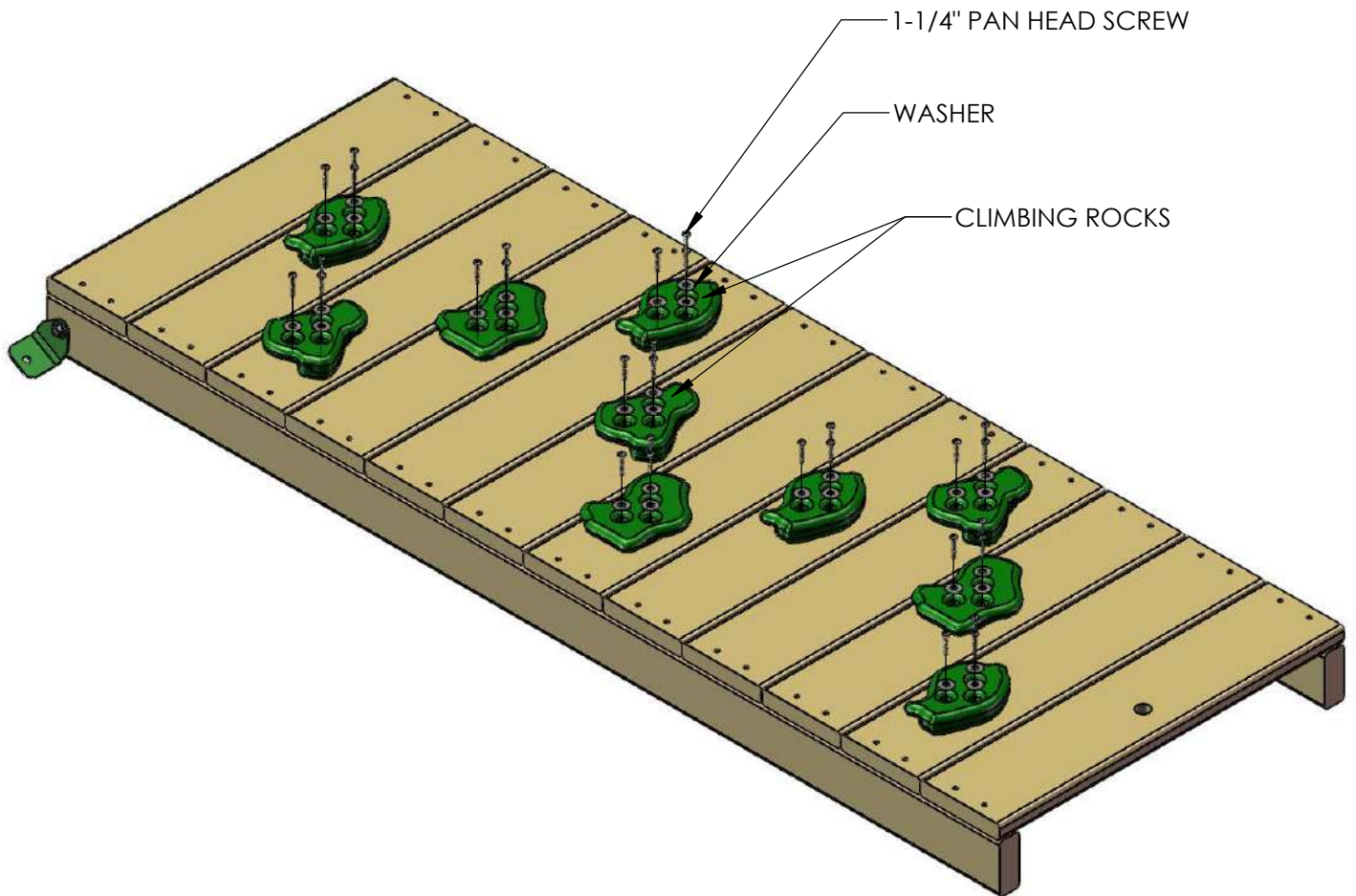

3: PLACE THE 5/4 X 3 X 23-7/8" ROCK WALL TOP CAP ON TOP OF THE ROCK WALL SIDES. FASTEN THE ROCK WALL TOP CAP TO THE ROCK WALL SIDES WITH 2" WOOD SCREWS.

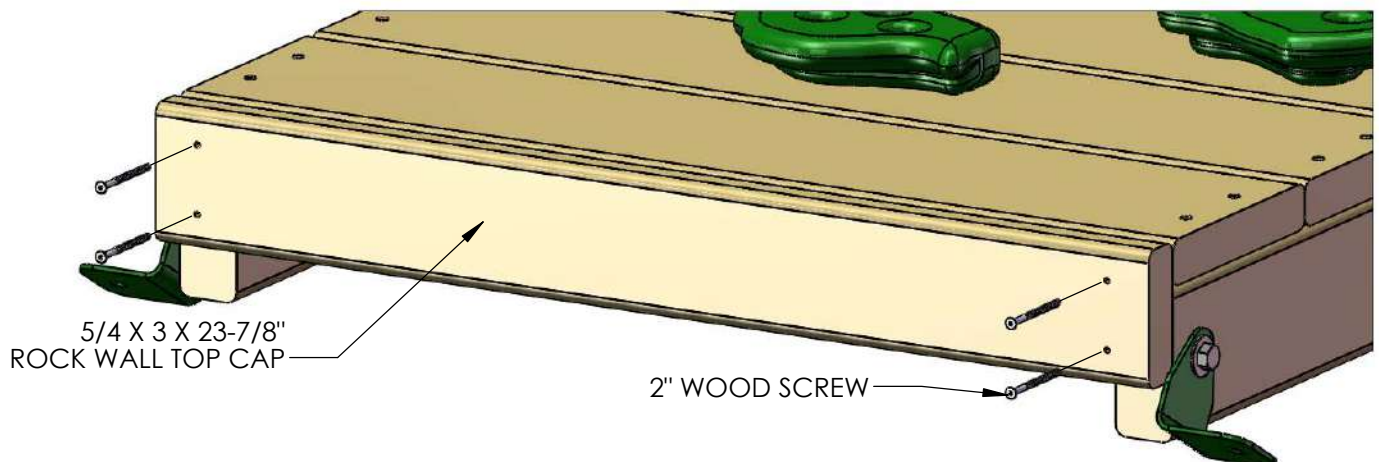

STEP 18: ATTACHING THE ROCK WALL

1: PLACE THE ROCK WALL INTO POSITION CENTERED ON THE FRONT - LEFT CUT OUT AREA OF THE FORT AS SHOWN BELOW. THE GREEN BRACKETS SHOULD BE $3/4$ " ABOVE THE BOTTOM OF THE FRONT FACE BOARD. USING THE 90 GREEN BRACKETS AS A TEMPLATE; DRILL A $3/8$ " HOLE THROUGH THE FRONT FACE BOARD.

2: GO UNDERNEATH THE DECK TO INSERT A T-NUT INTO THE BACKSIDE OF THE $3/8$ " HOLES IN THE FRONT FACE BOARD.

3: ATTACH THE ROCK WALL WITH $5/16$ X $1-1/2$ " BOLTS AND $5/16$ " WASHERS.

4: WHEN THE BRACKETS ARE SECURE, AND THE ROCK WALL IS IN ITS FINAL POSITION; TIGHTEN THE $5/16$ X $1-1/2$ " BOLTS ON THE ROCK WALL SIDES.

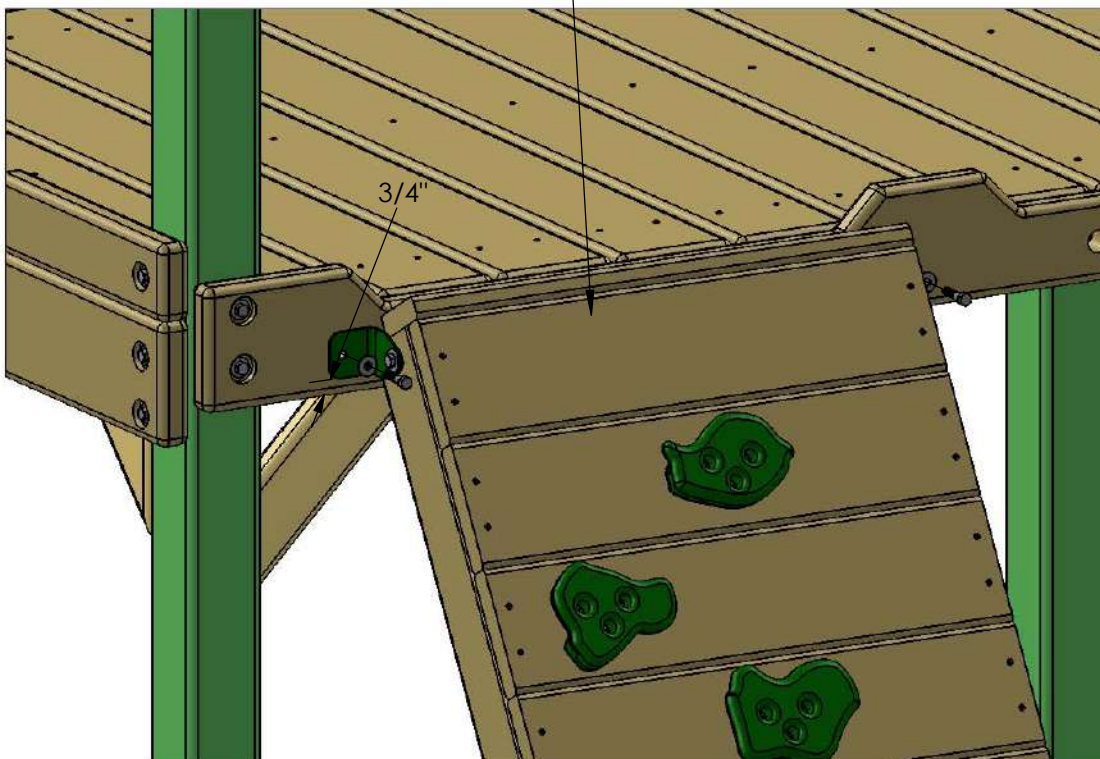
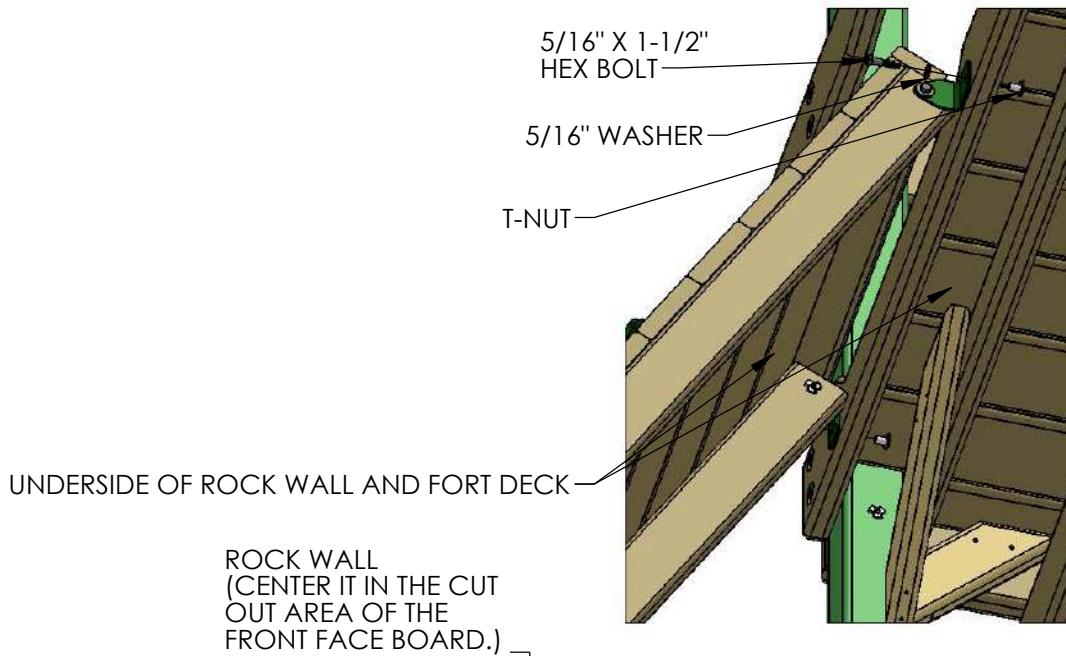

STEP 19: LADDER

1: FIND TWO 2 X 4 X 66" LADDER SIDES.

2: POSITION THE LADDER SIDES SO THAT THE SLOTS IN THE BOARDS ARE FACING EACH OTHER AND ARE PARALLEL.

3: INSERT T-NUTS INTO THE OUTSIDE OF THE LADDER SIDES AND SET WITH A HAMMER.

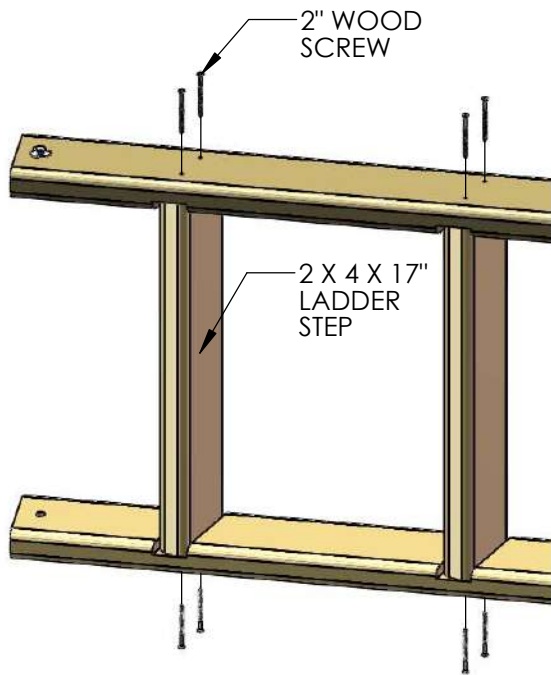
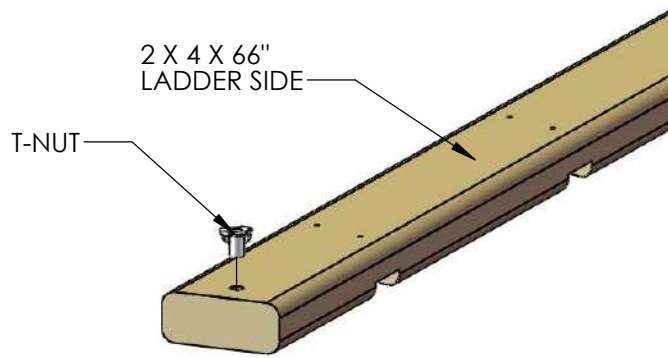

4: FIND FIVE 2 X 4 X 17" LADDER STEPS.

5: PLACE THE STEPS INTO THE SLOTS ON THE LADDER SIDES, AND FASTEN WITH 2" WOOD SCREWS.

6: CAREFULLY TURN THE LADDER OVER AND PUT THE SCREWS INTO THE OTHER SIDE.

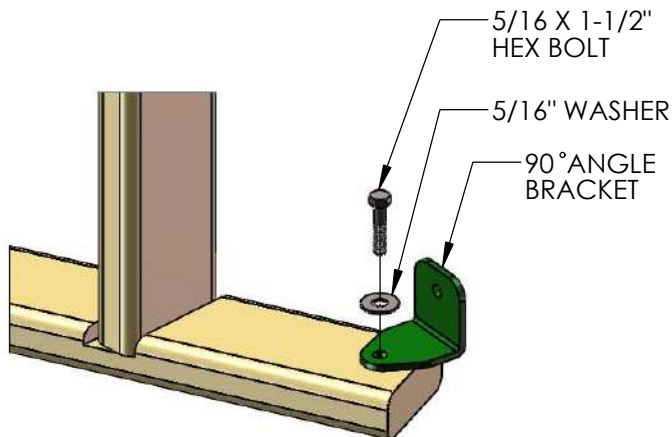

7: INSTALL THE 90° ANGLE BRACKETS TO THE INSIDE OF THE LADDER RAILS WITH 5/16 X 1-1/2" BOLTS, 5/16 WASHERS, INTO THE 5/16" T-NUTS.

8: INSTALL THE 5/4 X 3 X 18-3/4" LADDER BACK ABOVE THE TOP STEP OF THE LADDER WITH TWO 2" WOOD SCREWS PER SIDE.

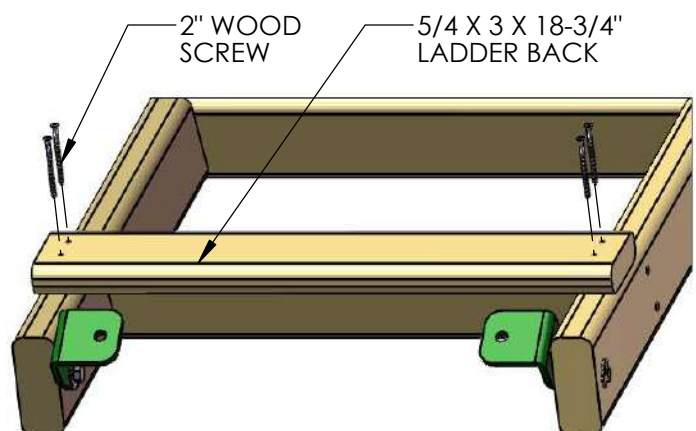

STEP 20: LADDER TO FORT

1: PLACE THE LADDER INTO POSITION ON THE LEFT SIDE OF THE FORT AS SHOWN BELOW. CENTER THE LADDER HORIZONTALLY ON THE 2 X 6. CENTER THE 90° BRACKETS VERTICALLY ON THE 2 X 6. USE THE HOLES IN THE LADDER BRACKETS AS A TEMPLATE TO DRILL 3/8" HOLES THROUGH THE BOTTOM PANEL BOARD.

2: FROM THE UNDERSIDE OF THE DECK INSERT A T-NUT INTO THE BACK SIDE OF THE 3/8" HOLES ON THE BOTTOM PANEL BOARD.

3: ATTACH THE LADDER WITH 5/16" X 1-1/2" HEX BOLTS AND 5/16" WASHERS.

4: WHEN THE BRACKETS ARE SECURE AND THE LADDER IS IN ITS FINAL POSITION, TIGHTEN THE 5/16" X 1-1/2" BOLTS ON THE LADDER SIDES.

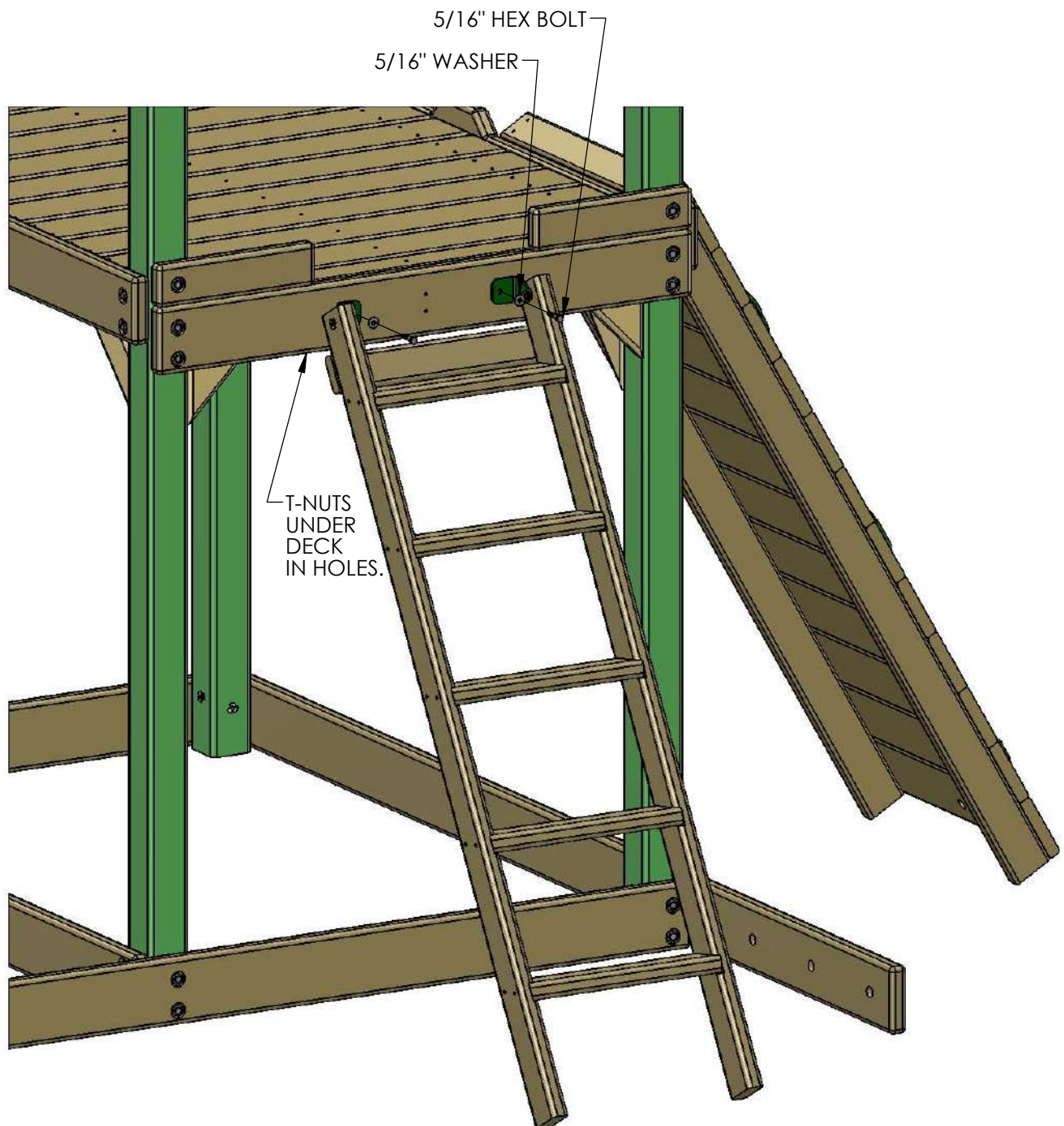

STEP 21: UPPER LEVEL CORNER POST T-NUTS

1: THIS STEP IS CRITICAL TO BUILDING THE UPPER LEVEL PROPERLY. IF ANY MISTAKES ARE MADE HERE, YOU WILL NEED TO DIS-ASSEMBLE AND THEN RE-ASSEMBLY TO MAKE YOUR CORRECTIONS.

2: MAKE SURE HOLES ARE FREE OF ANY OBSTRUCTIONS. USE A BOLT TO CLEAN OUT ANY DEBRIS.

3: USE THE DIAGRAM BELOW TO CORRECTLY IDENTIFY AND ORIENT POSTS PROPERLY.

4: USE A HAMMER TO SEAT THE T-NUTS AFTER INSERTING THEM INTO THE HOLES SHOWN IN THE DIAGRAM BELOW.

5: THE BARREL OF THE T-NUT SHOULD GO IN THE HOLE FIRST. HAMMER THE T-NUT UNTIL IT IS FLUSH/ALMOST FLUSH TO THE CORNER POST.

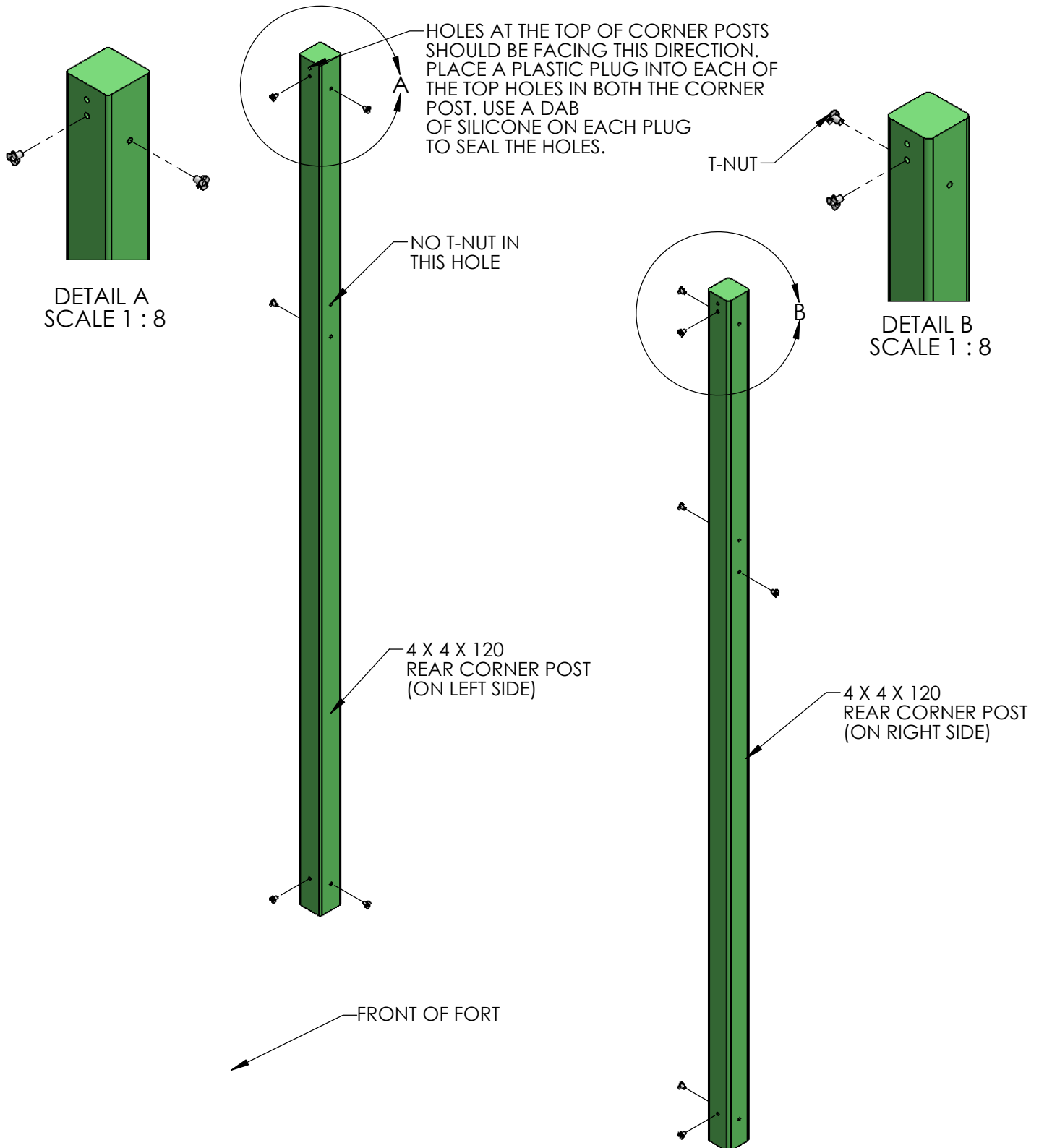

STEP 22: LAG POSTS

1: TWO 4 X 4 X 60-1/4" LAG POSTS WILL BE USED TO EXTEND THE MIDDLE CORNER POSTS TO ACCEPT THE UPPER LEVEL ROOF.

2: REST THE BOTTOM OF EACH LAG POST ON TOP OF THE 2 X 6 X 70" BACK PANEL BOARD.

3: CENTER EACH LAG POST DIRECTLY OVER THE CENTER OF THE MIDDLE CORNER POSTS.

4: ATTACH EACH LAG POST TO THE MIDDLE CORNER POST WITH 3/8" X 5" LAG SCREWS AND 3/8" WASHERS.

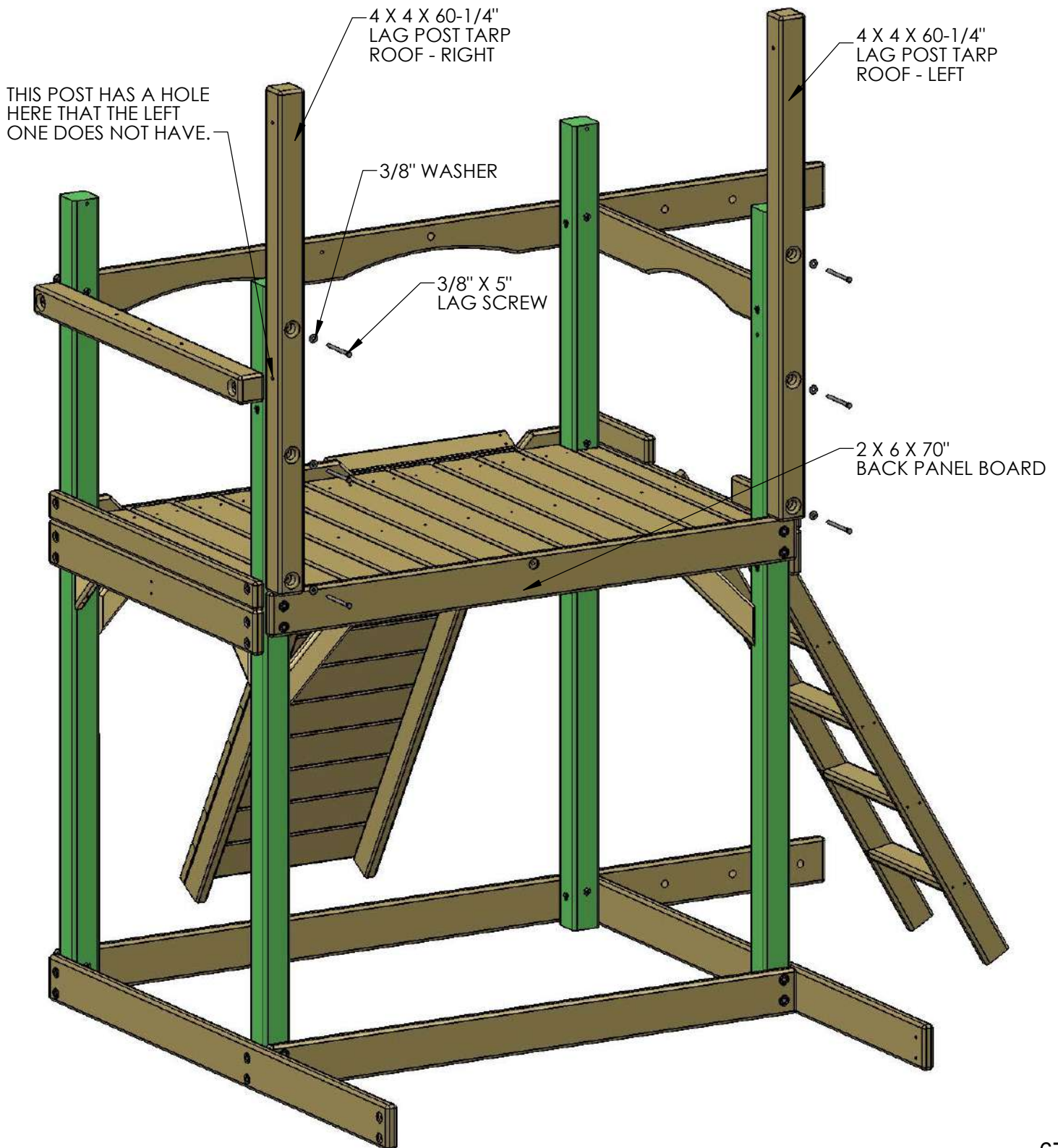

STEP 23: REAR CORNER POSTS & DECK SUPPORTS & SIDE TOP PANEL BOARDS

1: HAMMER A T-NUT INTO THE HOLES AT THE TOP OF THE LAG POSTS.

TIP: BEFORE YOU INSTALL THESE BOARDS LEAVE THEM ALL A LITTLE LOOSE. WHEN YOU HAVE FASTENERS IN ALL THE BOARDS GO BACK AND TIGHTEN THEM ALL UP.

2: PLACE THE 2 X 4 X 30-7/16" SIDE TOP PANEL BOARDS (OFFSET DOWN) AT THE TOP OF THE CORNER POSTS ON THE SIDES OF THE FORT. USE 5/16" X 4-1/2" HEX BOLTS AND 5/16" WASHERS TO ATTACH EACH SIDE TOP PANEL BOARD TO THE LAG/CORNER POSTS.

3: PLACE THE 2 X 4 X 34" UPPER LEVEL DECK SUPPORTS ON THE INSIDE OF THE LAG/CORNER POSTS. ATTACH EACH UPPER LEVEL DECK SUPPORT WITH 5/16" X 4-1/2" HEX BOLTS AND 5/16" WASHERS.

4: ATTACH THE BOTTOM OF THE REAR CORNER POSTS TO THE SIDE SANDBOX BOARDS WITH 5/16" X 4-1/2" HEX BOLTS AND 5/16" WASHERS.

5: TIGHTEN ALL THE FASTENERS.

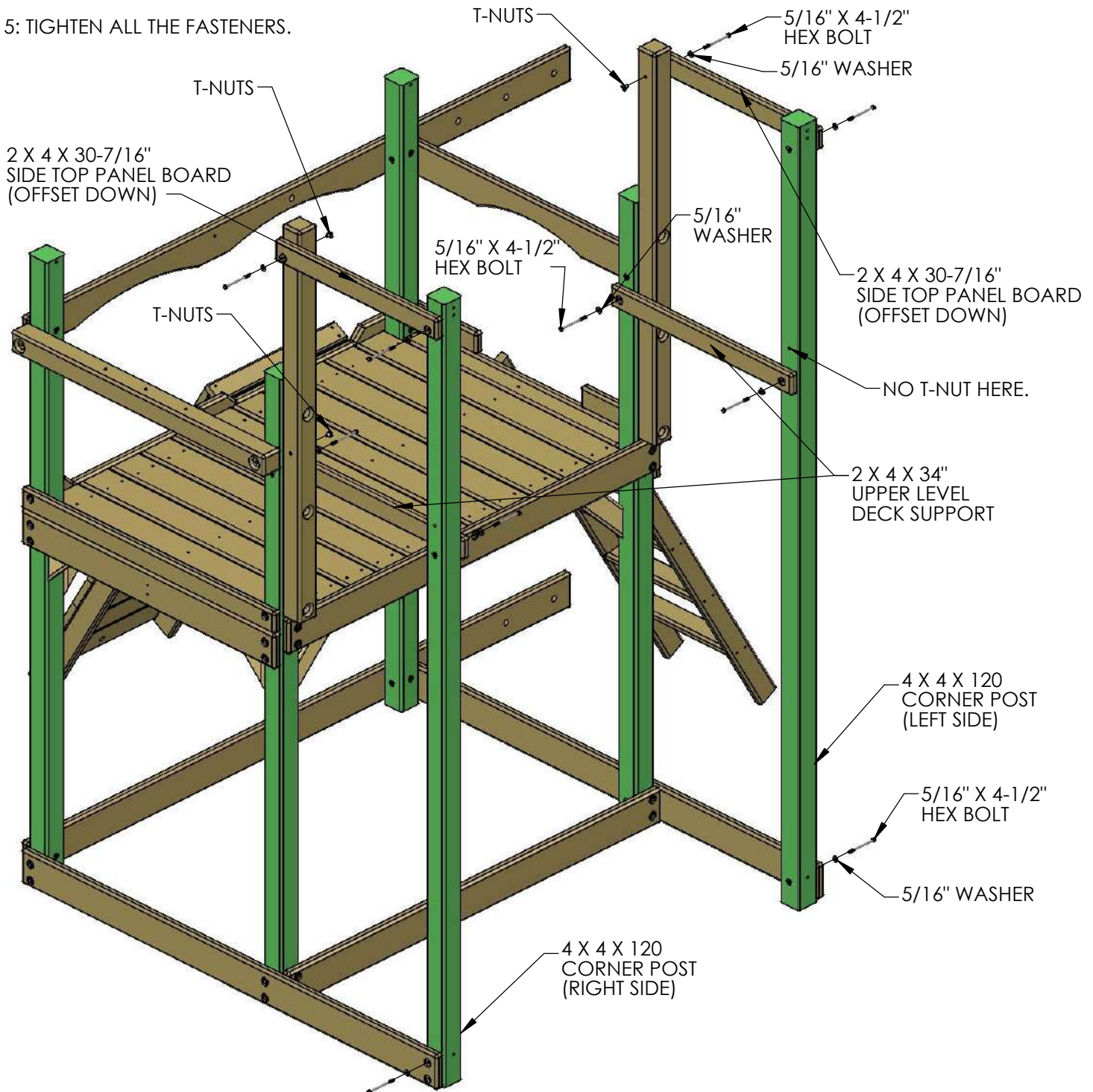

STEP 24: UPPER LEVEL - RAILING & UNDER DECK SUPPORT

1: PLACE THE 2 X 4 X 70" UPPER LEVEL STEPS/RAILING BOARD (3 HOLES ON CENTER) AT THE TOP OF THE REAR CORNER POSTS. THIS BOARD WILL GET ATTACHED TO THE 2ND HOLE DOWN FROM THE TOP OF THE POSTS. THE T-NUT FOR THIS BOARD SHOULD BE ON THE INSIDE OF EACH POST ALREADY. FASTEN THE UPPER LEVEL RAILING BOARD TO THE REAR CORNER POSTS WITH 5/16" X 4-1/2" HEX BOLTS AND 5/16" WASHERS.

2: PLACE THE 2 X 6 X 70" SANDBOX BOARD (OFFSET UP) AT THE BOTTOM OF THE REAR CORNER POSTS. FASTEN THE TOP HOLES IN THE SANDBOX BOARD TO THE REAR CORNER POSTS WITH 5/16" X 4-1/2" HEX BOLTS AND 5/16" WASHERS.

3: PLACE THE 4 X 4 X 70" UPPER LEVEL UNDER DECK SUPPORT DIRECTLY UNDERNEATH THE UPPER LEVEL DECK SUPPORTS. ATTACH THE UNDER DECK SUPPORT TO THE REAR CORNER POSTS WITH 3/8" X 5" LAG SCREWS AND 3/8" WASHERS.

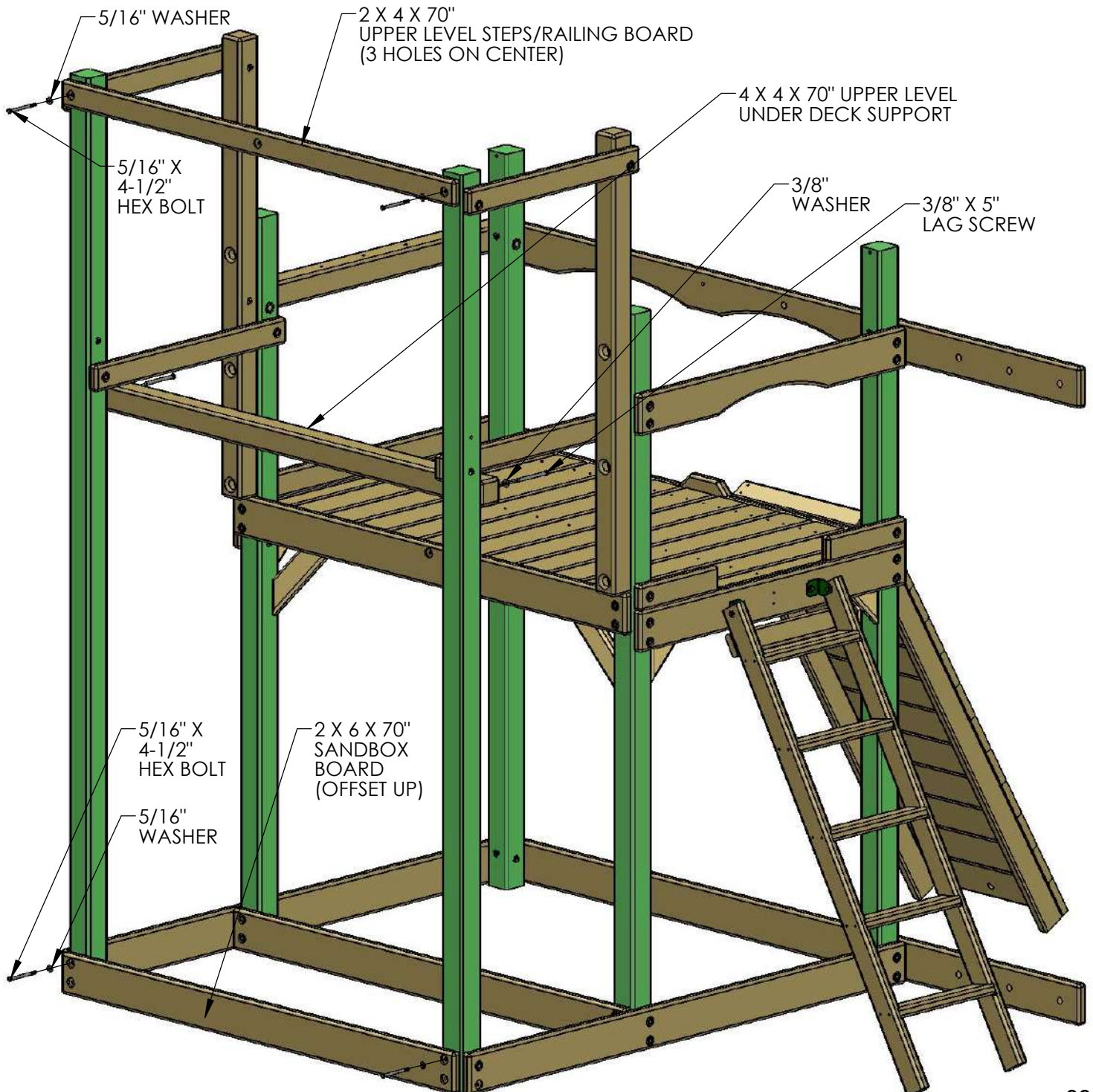

STEP 25: CENTER DECK SUPPORT ASSEMBLY

NOTE: IT IS BEST TO PLACE THESE BOARDS UPON A FLAT SURFACE BEFORE ATTACHING THEM TOGETHER.

1: PLACE ONE 2 X 4 X 34" UPPER LEVEL CENTER DECK SUPPORT (OFFSET UP) ON THE RIGHT SIDE OF THE 4 X 4 X 30-1/2" UPPER LEVEL CENTER BLOCK SUPPORT. PLACE ONE MORE 2 X 4 X 34" UPPER LEVEL CENTER DECK SUPPORT (OFFSET DOWN) ON THE LEFT SIDE OF THE 4 X 4 X 30-1/2" UPPER LEVEL CENTER BLOCK SUPPORT.

2: MAKE SURE THE ENDS AND BOTTOMS OF THE BOARDS ARE FLUSH TO ONE ANOTHER.

3: ATTACH EACH 2 X 4 TO THE 4 X 4 WITH 5/16" X 3-1/2" LAG SCREWS AND 5/16" WASHERS.

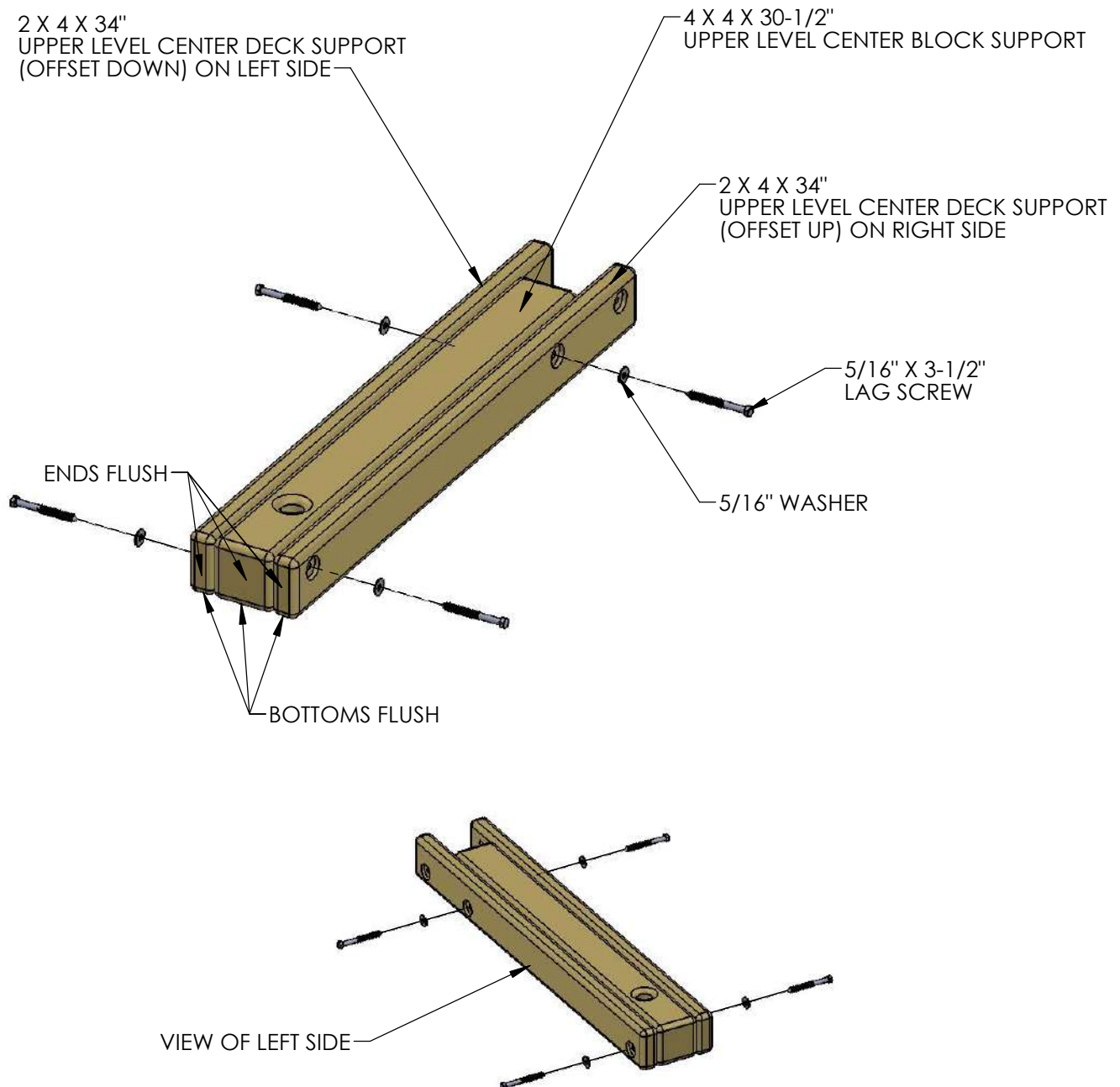

STEP 26: LOWER LEVEL CENTER POST

1: HAMMER A T-NUT INTO THE 4 X 4 X 71-7/8" REAR CENTER POST LOWER LEVEL.

2: ATTACH THE LOWER LEVEL CENTER POST TO THE MIDDLE HOLE OF THE 2 X 6 X 70" BACK PANEL BOARD. USE A 5/16" X 4-1/2" HEX BOLT AND A 5/16" WASHER TO ATTACH THE BOARDS TOGETHER.

3: HAVE AN ASSISTANT HOLD THIS BOARD UP FOR YOU AND PROCEED TO STEP 27.

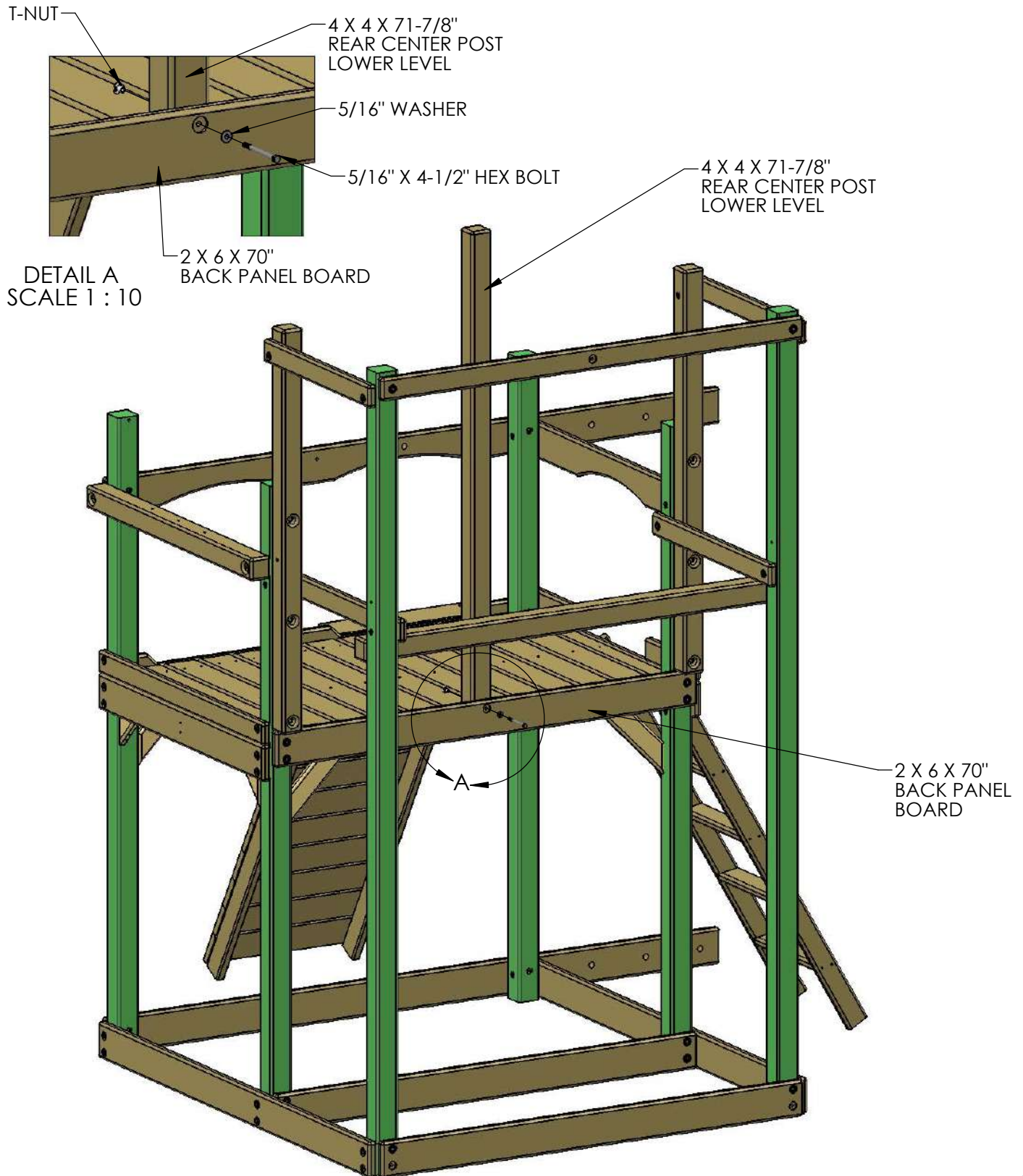

STEP 27: CENTER DECK SUPPORT ASSEMBLY INSTALLATION AND LAGS

1: PLACE THE CENTER DECK SUPPORT ASSEMBLY ON TOP OF THE 4 X 4 X 70" UPPER LEVEL UNDER DECK SUPPORT. THE 4 X 4 X 71-7/8" REAR CENTER POST LOWER LEVEL SHOULD FIT INSIDE THE CENTER DECK SUPPORT ASSEMBLY.

2: MAKE THE CENTER DECK SUPPORT ASSEMBLY LEVEL WITH THE CENTER DECK SUPPORTS. THE END OF THE CENTER DECK SUPPORT ASSEMBLY SHOULD BE FLUSH TO THE SIDE OF THE LOWER LEVEL CENTER POST.

3: ATTACH THE CENTER DECK SUPPORT ASSEMBLY TO THE 4 X 4 X 59-1/2" LOWER LEVEL CENTER POST WITH 5/16" X 3-1/2" LAG SCREWS AND 5/16" WASHERS.

4: CENTER THE CENTER DECK SUPPORT ASSEMBLY ON TOP OF THE 4 X 4 X 70" UPPER LEVEL UNDER DECK SUPPORT. LEAVE AN EQUAL SPACE ON EACH SIDE OF THE CENTER DECK SUPPORT ASSEMBLY. THE END OF THE CENTER DECK SUPPORT ASSEMBLY SHOULD BE FLUSH TO THE OUTSIDE OF THE REAR CORNER POSTS.

5: FASTEN THE CENTER DECK SUPPORT ASSEMBLY TO THE 4 X 4 X 70" UPPER LEVEL UNDER DECK SUPPORT WITH A 3/8" X 5" LAG SCREW AND A 3/8" WASHER.

6: FASTEN THE BOTTOM HOLES OF THE SIDE SANDBOX BOARDS/REAR SANDBOX BOARD TO THE REAR CORNER POSTS WITH 5/16" X 3-1/2" LAG SCREWS AND 5/16" WASHERS.

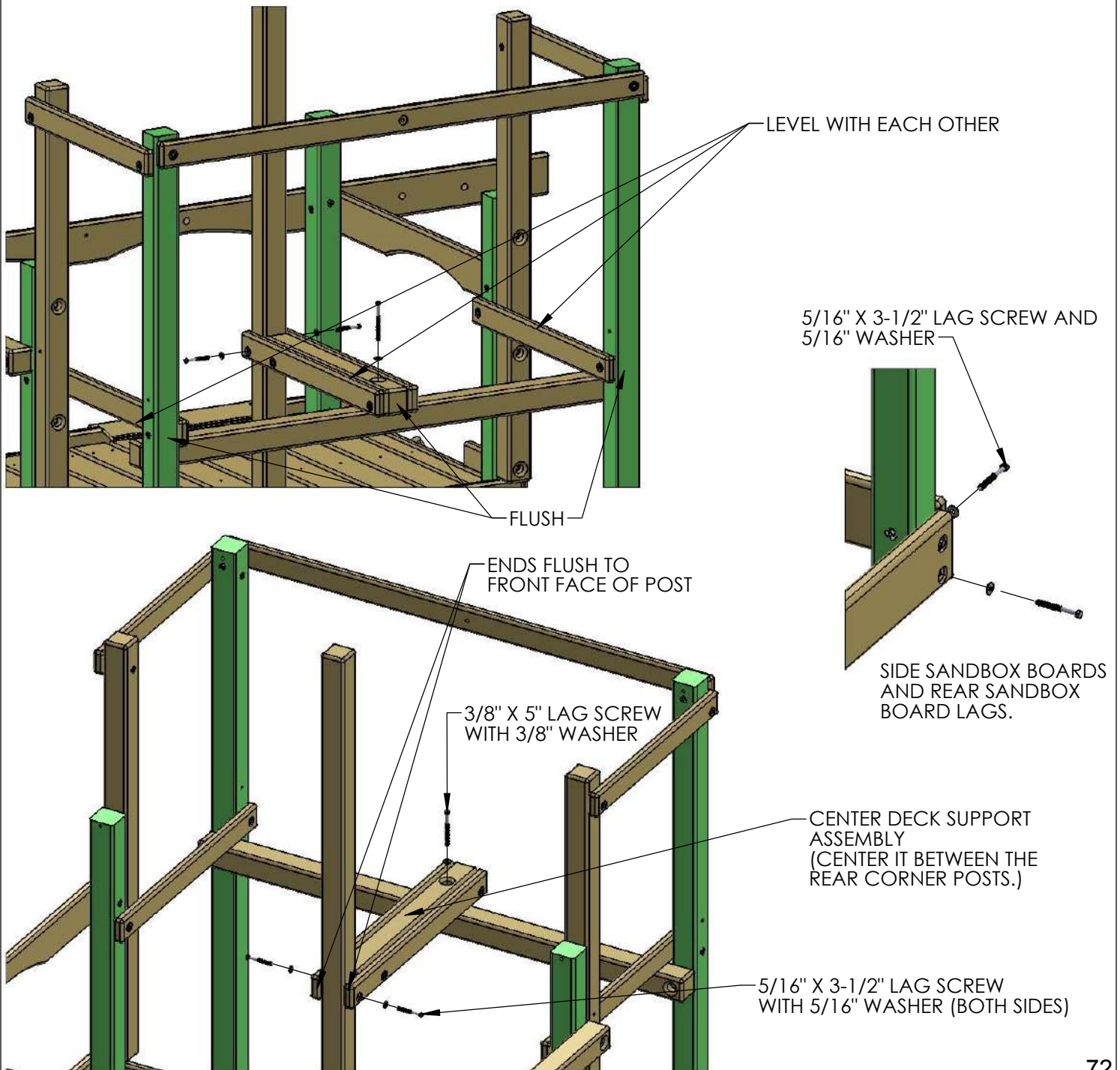

STEP 28: UPPER LEVEL DECK SPACERS

- 1: MAKE SURE THE REAR CENTER POST LOWER LEVEL HAS AN EQUAL OPENING ON EACH SIDE.
- 2: PLACE THE 5/4 X 4 X 29-1/2" UPPER DECK SPACERS BETWEEN THE LOWER LEVEL CENTER POST AND THE MIDDLE CORNER POSTS. ATTACH EACH UPPER DECK SPACER TO THE DECK SUPPORTS WITH #8 X 2" WOOD SCREWS.
- 3: PLACE THE 5/4 X 4 X 63" UPPER DECK SPACER BETWEEN THE UPPER LEVEL LAG POSTS. ATTACH THE UPPER DECK SPACER TO THE DECK SUPPORTS WITH #8 X 2" WOOD SCREWS.

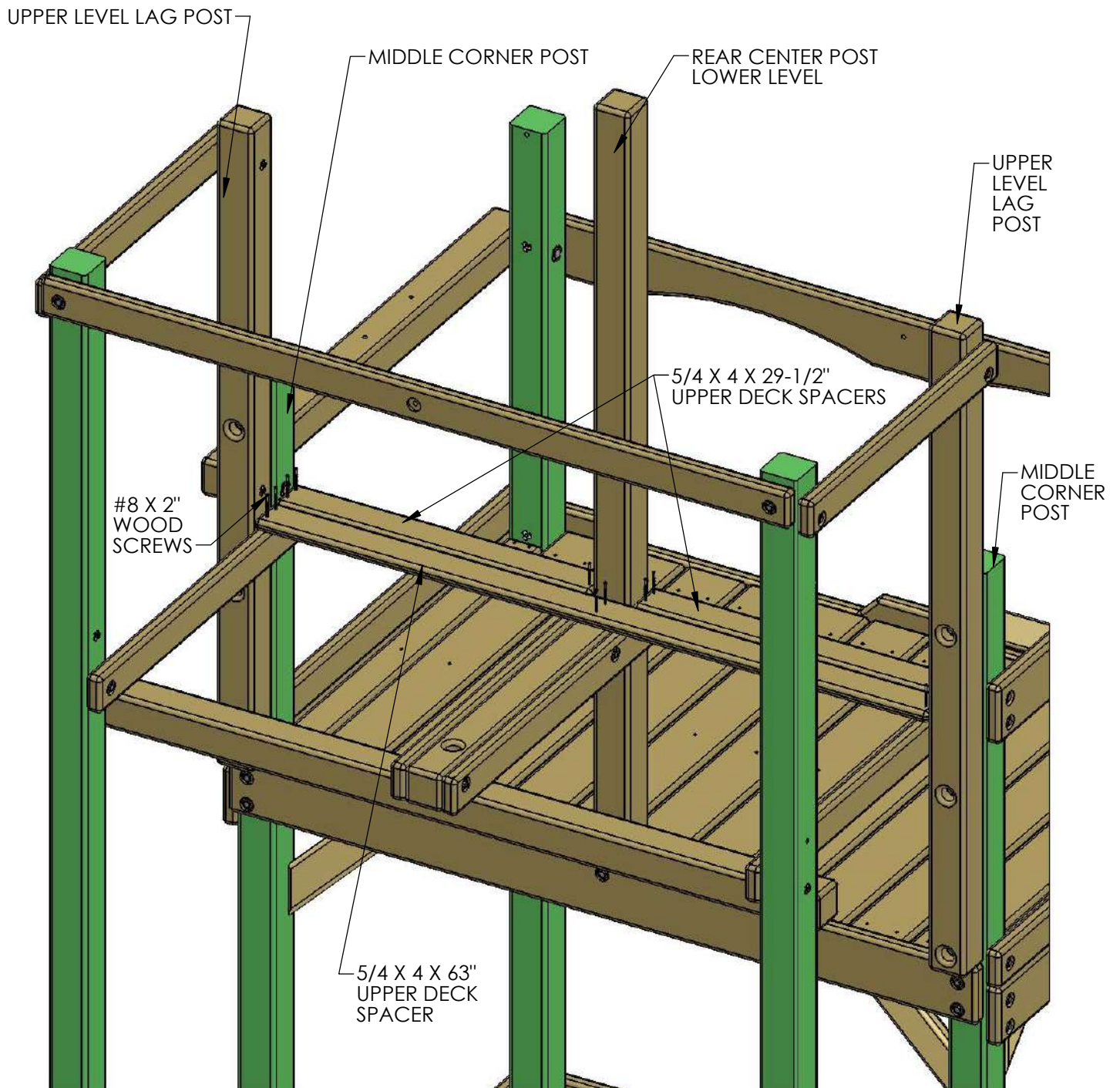

STEP 29: SLIDE BLOCK

1: PLACE THE 4 X 4 X 23-1/2" SLIDE BLOCK AGAINST THE UPPER DECK SUPPORT ON THE LEFT SIDE (LADDER SIDE) OF THE PLAY SET. THE TOP OF THE BLOCK SHOULD BE FLUSH TO THE TOP OF THE DECK SUPPORT. THE BLOCK FITS BETWEEN THE LAG POST AND THE REAR CORNER POST.

2: HAVE AN ASSISTANT HOLD THE BOARD IN POSITION OR USE A CLAMP TO HOLD THE BOARD FIRMLY TO THE DECK SUPPORT. USE THE HOLES IN THE SLIDE BLOCK AS A TEMPLATE TO DRILL 3/8" HOLES THROUGH THE DECK SUPPORT.

3: HAMMER T-NUTS INTO THE HOLES ON THE INSIDE FACE OF THE DECK SUPPORT. ATTACH THE SLIDE BLOCK TO THE DECK SUPPORT WITH 5/16" X 4-1/2" HEX BOLTS AND 5/16" WASHERS.

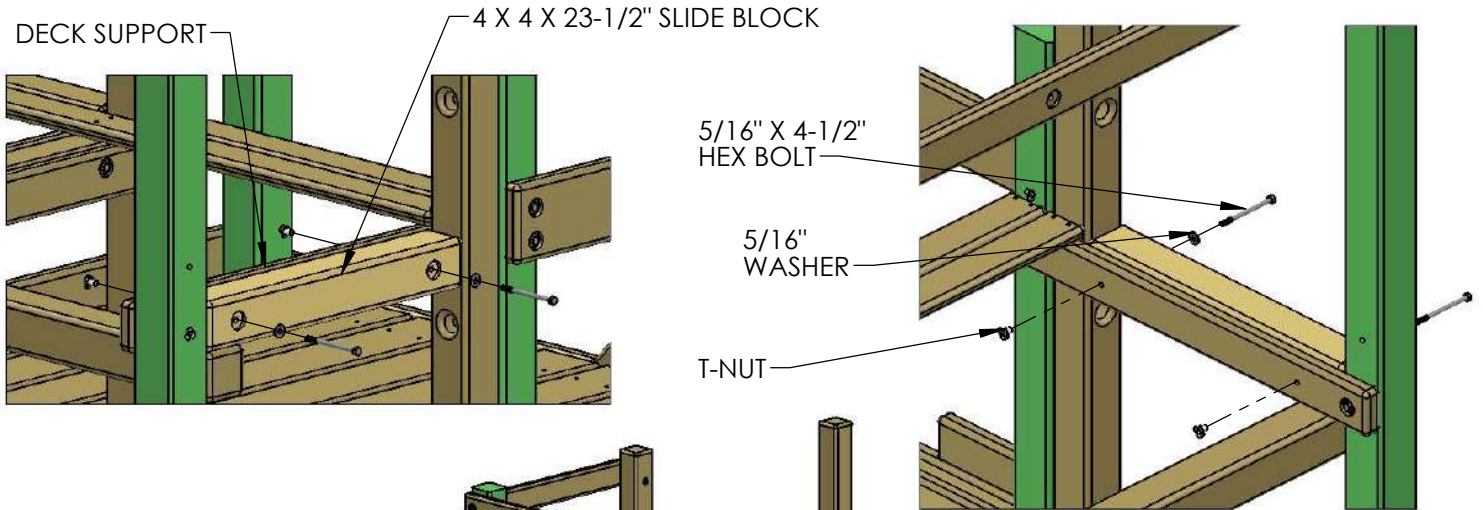

DETAIL A
SCALE 2 : 25

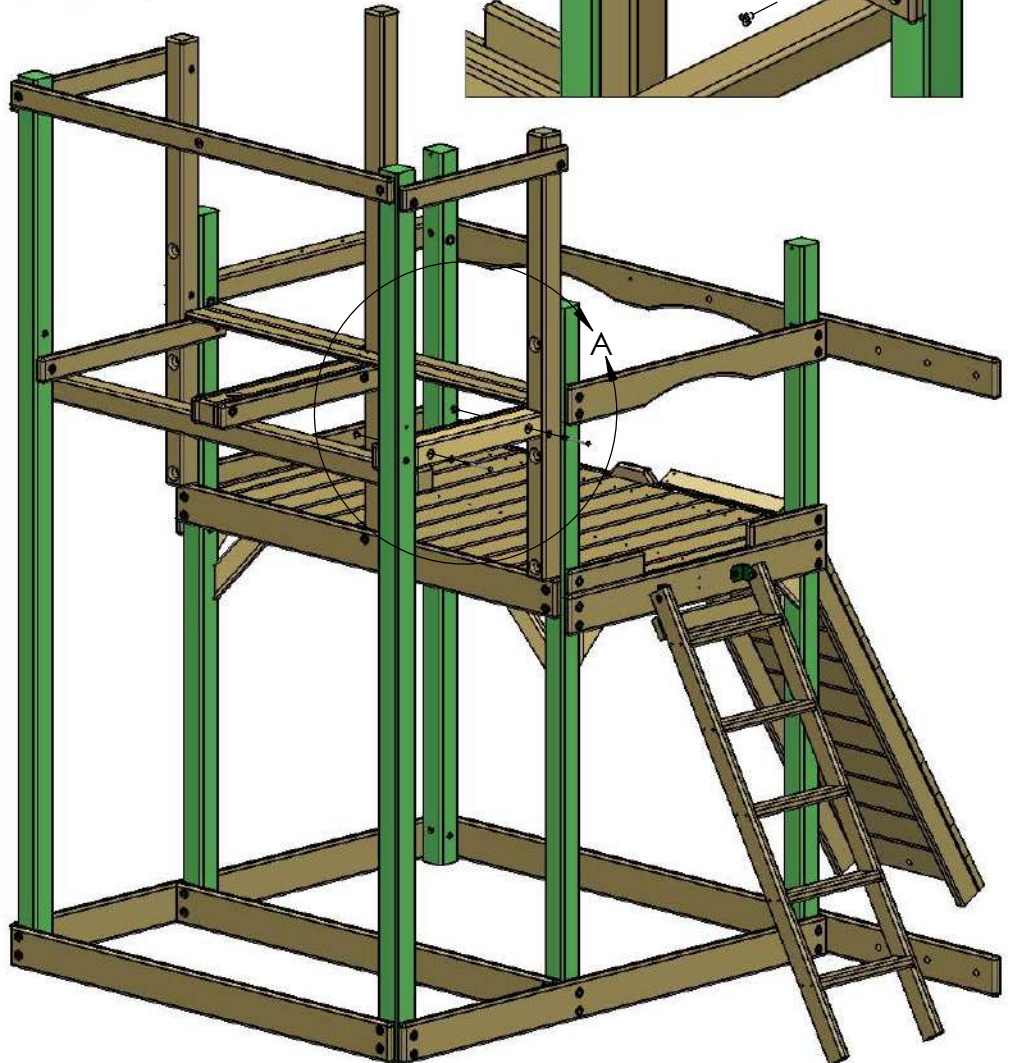

STEP 30: ANGLE SUPPORT - UPPER LEVEL REAR

1: PLACE A 2 X 4 X 18" ANGLE SUPPORT -UPPER LEVEL REAR AGAINST THE 4 X 4 X 70" UPPER LEVEL UNDER DECK SUPPORT ON EACH SIDE AT THE REAR OF THE PLAY SET.

2: THE TOP OF THE ANGLE SUPPORT SHOULD BE FLUSH TO THE TOP OF THE UNDER DECK SUPPORT. FASTEN THE TOP OF THE ANGLE SUPPORT TO THE UNDER DECK SUPPORT WITH FOUR #8 X 2-1/2" WOOD SCREWS.

3: FASTEN THE BOTTOM OF THE ANGLE SUPPORT TO THE REAR CORNER POST WITH ONE #8 X 2" WOOD SCREW AND ONE #8 X 3" WOOD SCREW.

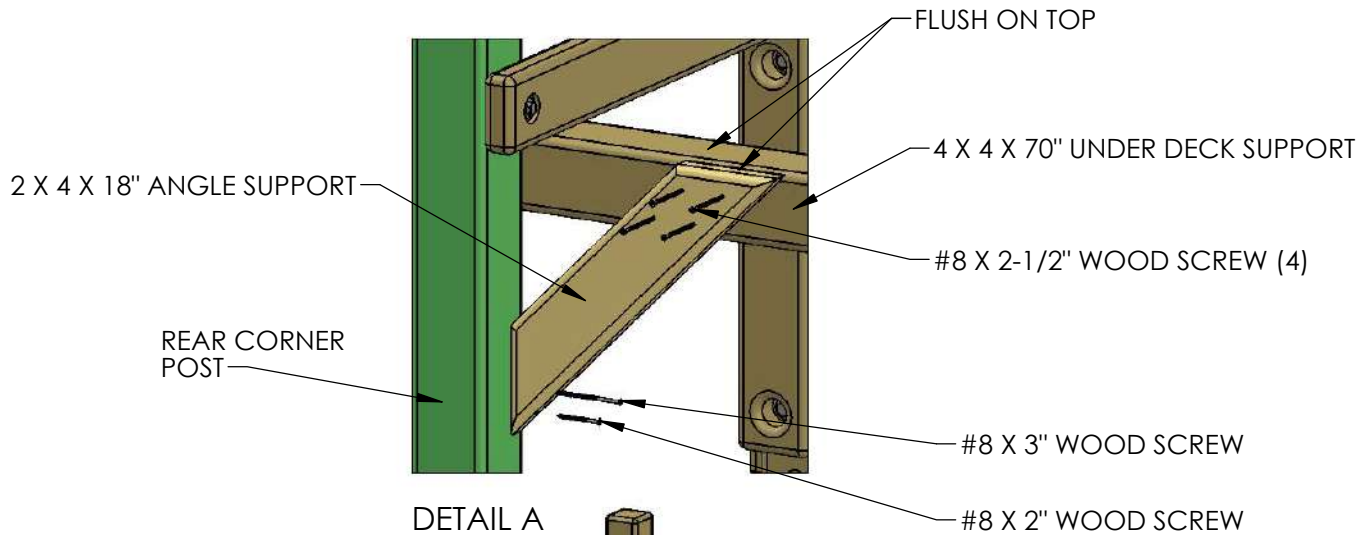

DETAIL A
SCALE 1 : 8

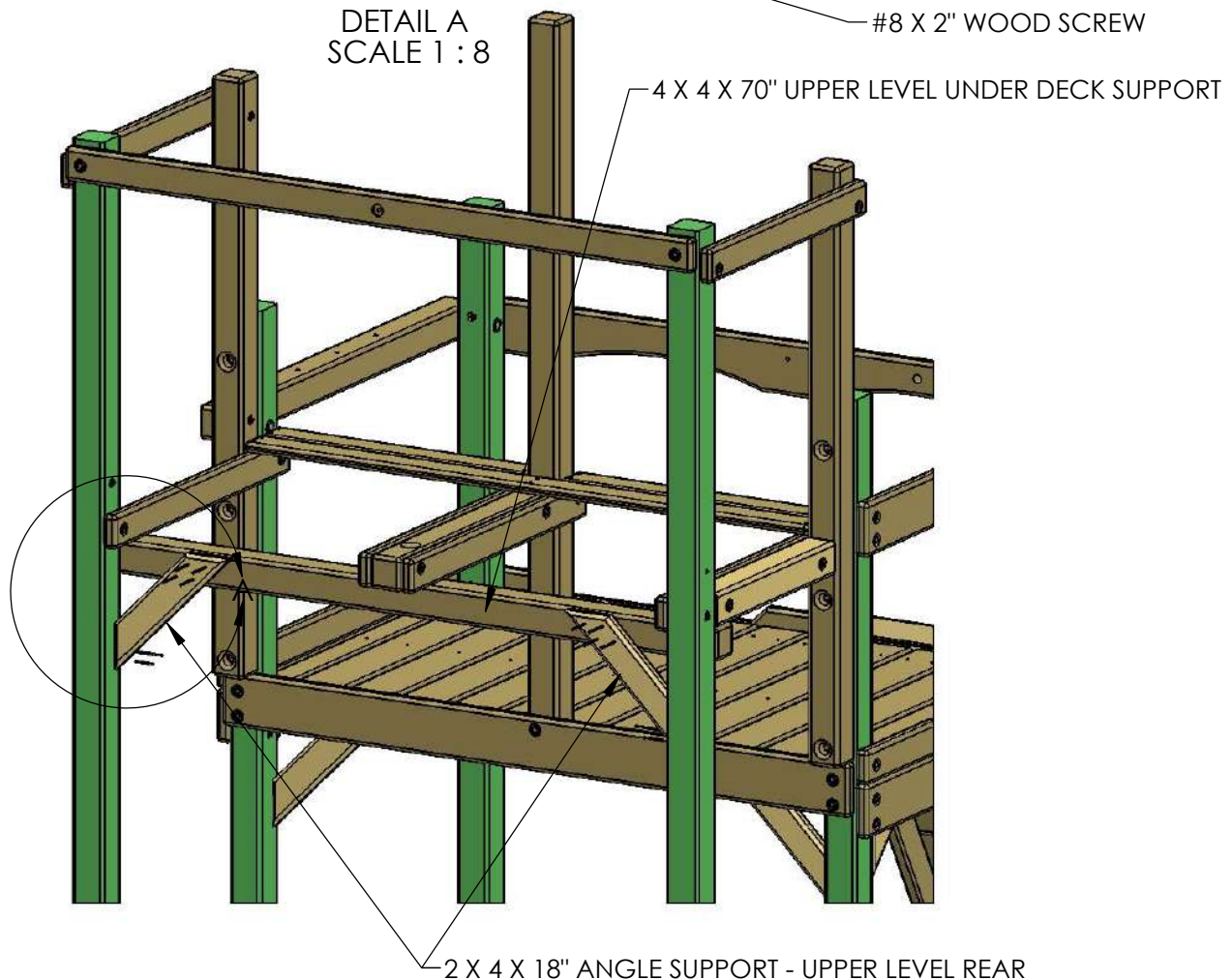

STEP 31: SIDE REAR ANGLE SUPPORTS

1: (SEE DETAIL A) PLACE THE 2 X 4 X 18" ANGLE SUPPORT UPPER LEVEL RAD RIDE SIDE UNDER THE 4 X 4 X 23-1/2" SLIDE BLOCK ON THE LEFT SIDE OF THE FORT. THE ANGLE SUPPORT SHOULD BE FLUSH TO THE LEFT SIDE OF THE LEFT REAR CORNER POST. ATTACH THE ANGLE SUPPORT AT THE TOP AND AT THE BOTTOM WITH ONE #8 X 2" WOOD SCREW AND ONE #8 X 3" WOOD SCREW.

2: (SEE DETAIL B) PLACE THE 2 X 4 X 21-1/2" ANGLE SUPPORT UPPER LEVEL SWING SIDE AGAINST THE 2 X 4 X 34" UPPER LEVEL DECK SUPPORT ON THE RIGHT SIDE OF THE FORT. THE TOP OF THE ANGLE SUPPORT SHOULD BE FLUSH TO THE TOP OF THE DECK SUPPORT. FASTEN THE TOP OF THE ANGLE SUPPORT TO THE DECK SUPPORT WITH FOUR #8 X 2-1/2" WOOD SCREWS. FASTEN THE BOTTOM OF THE ANGLE SUPPORT TO THE RIGHT REAR CORNER POST WITH ONE #8 X 2" WOOD SCREW AND ONE #8 X 3" WOOD SCREW.

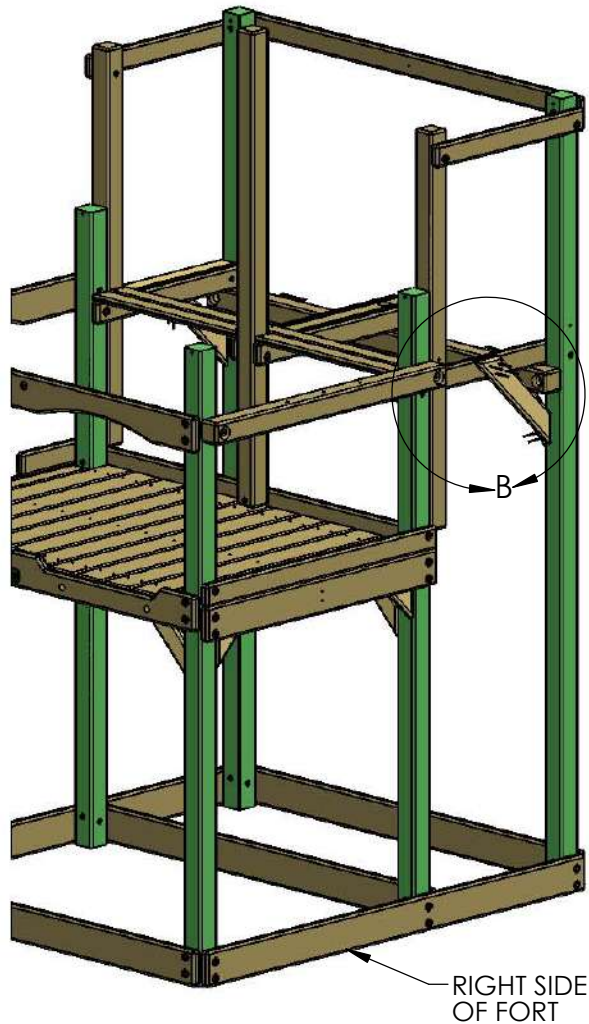
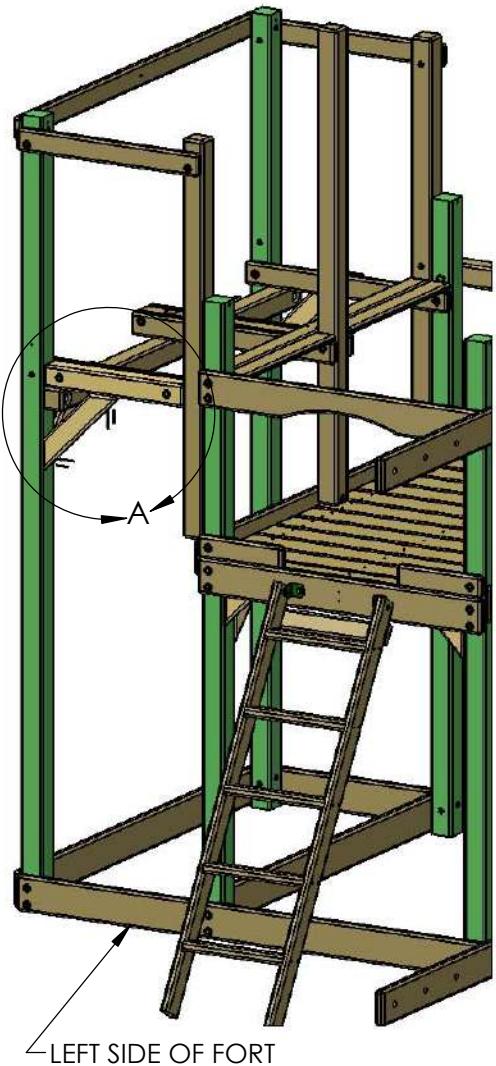
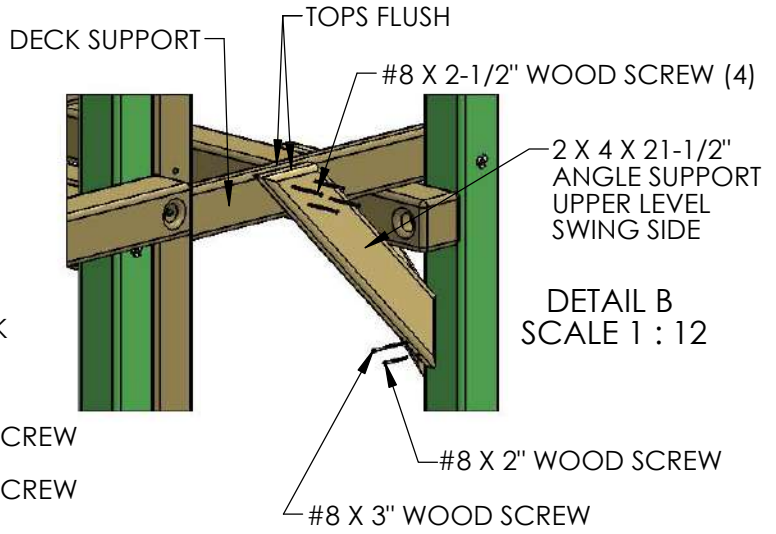
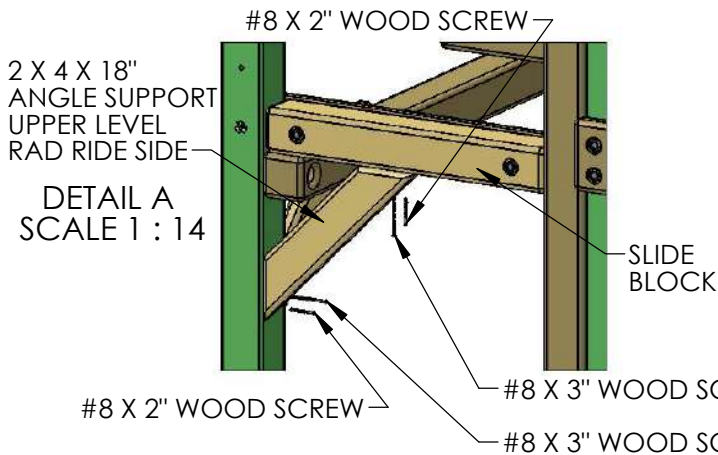

STEP 32: UPPER LEVEL DECK BOARDS

1: PLACE FOUR 5/4 X 6 X 69-7/8" UPPER DECK BOARDS ACROSS THE DECK SUPPORTS AS SHOWN. EQUALLY SPACE THE DECK BOARDS 5/16" FROM ONE ANOTHER AND FROM THE DECK SPACER.

2: SECURE EACH UPPER DECK BOARD TO THE DECK SUPPORTS WITH FIVE #8 X 2" WOOD SCREWS.

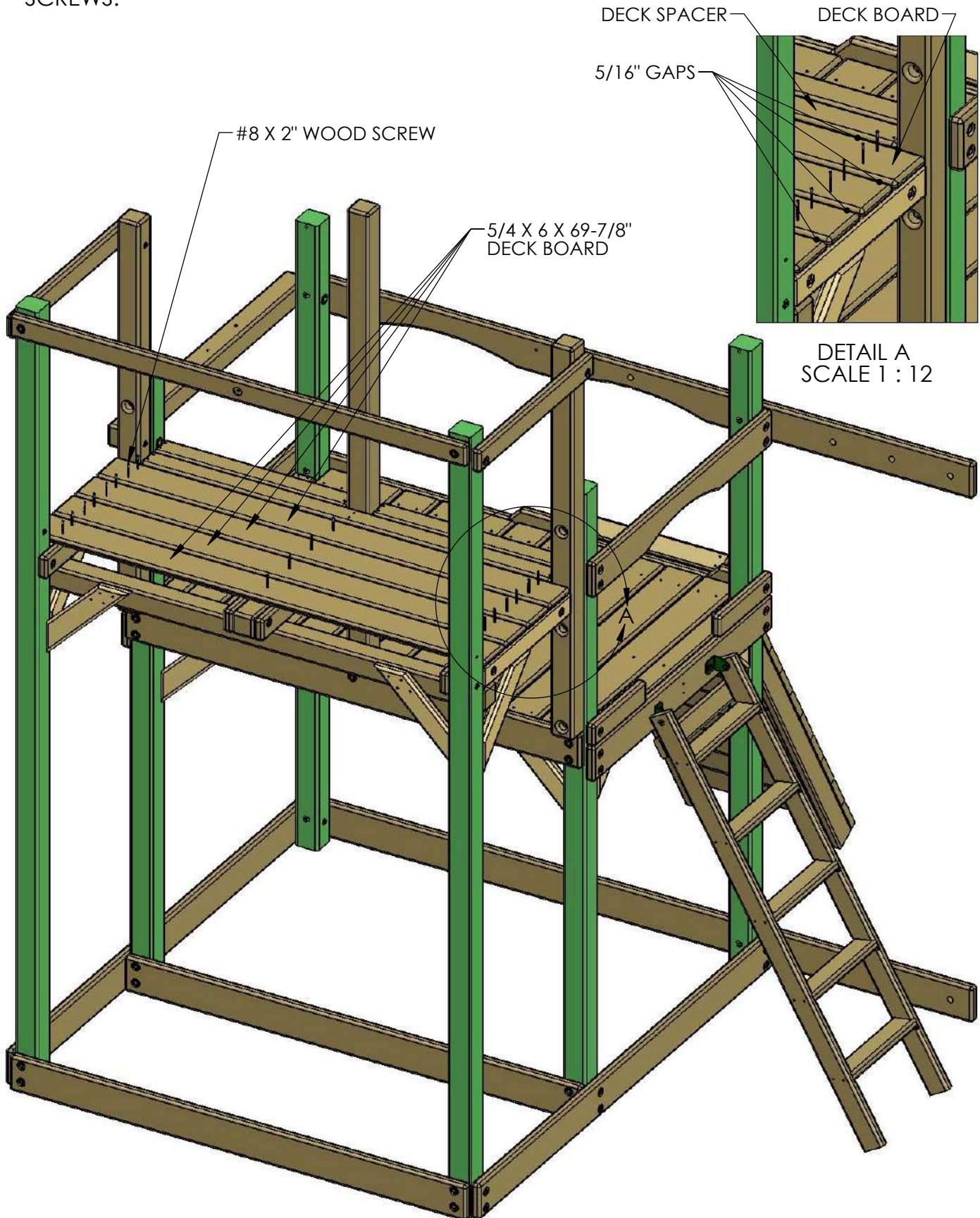

STEP 33: SLIDE POST ASSEMBLY

1: PREDRILL TWO 1/8" PILOT HOLES CENTERED VERTICALLY ON THE NOTCH IN THE 4 X 4 X 43-1/2" RAD RIDE CENTER POST.

2: PLACE ONE END OF THE 5/4 X 4 X 25" RAD RIDE DECK SPACER INTO THE NOTCH IN THE RAD RIDE CENTER POST. THE END WITHOUT ANY PREDRILLED HOLES GOES INTO THE NOTCH.

3: FASTEN THE RAD RIDE DECK SPACER TO THE RAD RIDE CENTER POST WITH TWO #8 X 3-1/2" WOOD SCREWS.

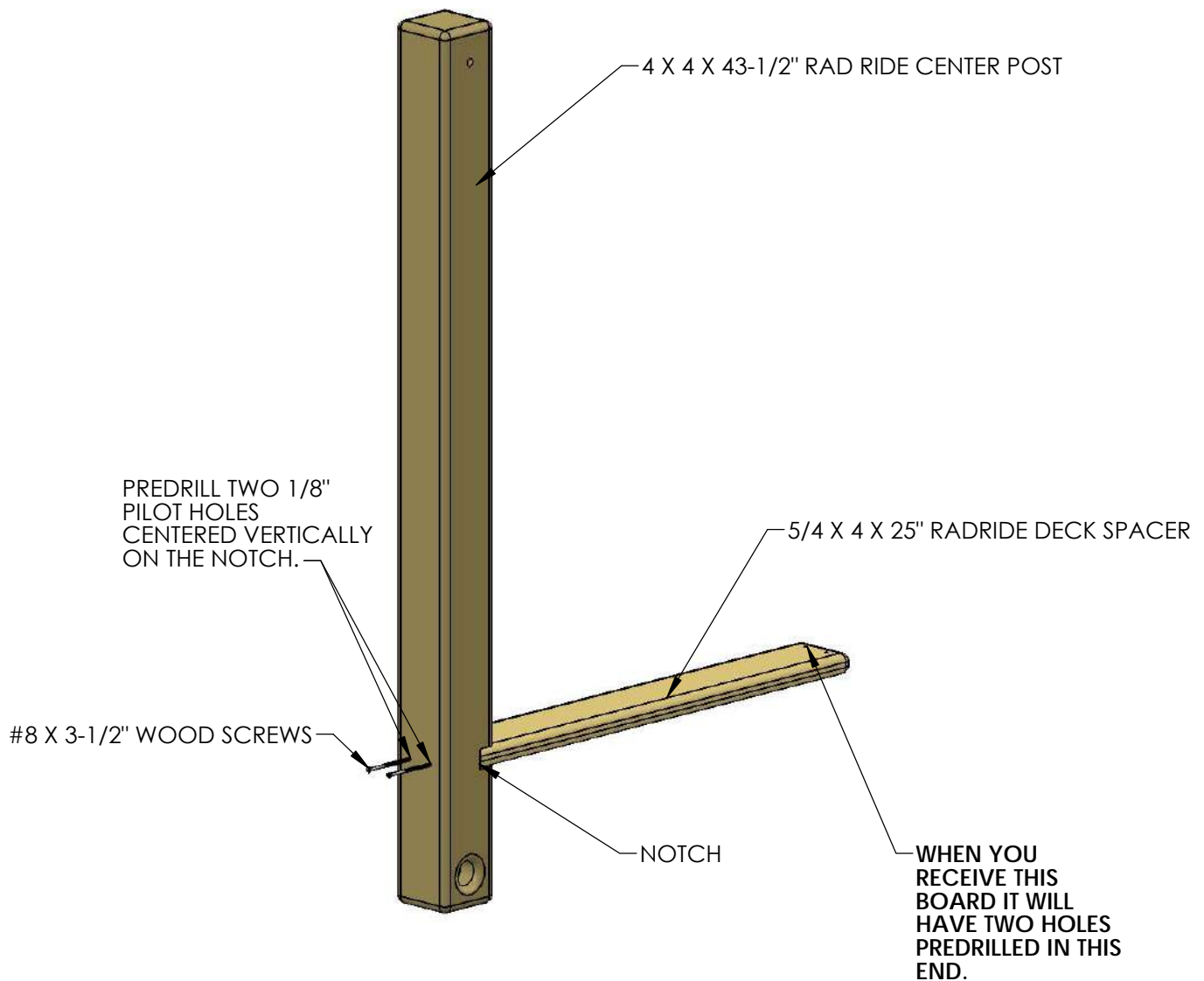

STEP 34: SLIDE POST INSTALLATION

1: PLACE THE END OF THE DECK SPACER AGAINST THE CORNER POST. THE OUTSIDE OF THE DECK SPACER SHOULD BE FLUSH TO THE OUTSIDE OF THE CORNER POST. FASTEN THE DECK SPACER TO THE DECK SUPPORT WITH #8 X 2" WOOD SCREWS.

2: MAKE THE DECK SPACER LEVEL WITH THE DECK BOARD BEHIND IT. DRIVE A 3/8" X 5" LAG SCREW WITH 3/8" WASHER THROUGH THE RAD RIDE CENTER POST INTO THE 4 X 4 X 70" UNDER DECK SUPPORT.

3: MEASURE THE BOTTOM OPENING AND RECORD THIS MEASUREMENT. MEASURE AT THE TOP OF THE OPENING. MAKE THE TOP OF THE OPENING THE SAME AS THE MEASUREMENT YOU RECORDED. NOW USE THE TOP HOLE IN THE RAD RIDE CENTER POST TO DRILL A 3/8" HOLE THROUGH THE 2 X 4 X 70" RAILING.

4: PLACE A T-NUT INTO THE HOLE IN THE RAILING. FASTEN THE RAD RIDE CENTER POST TO THE RAILING WITH A 5/16" X 4-1/2" HEX BOLT AND 5/16" WASHER.

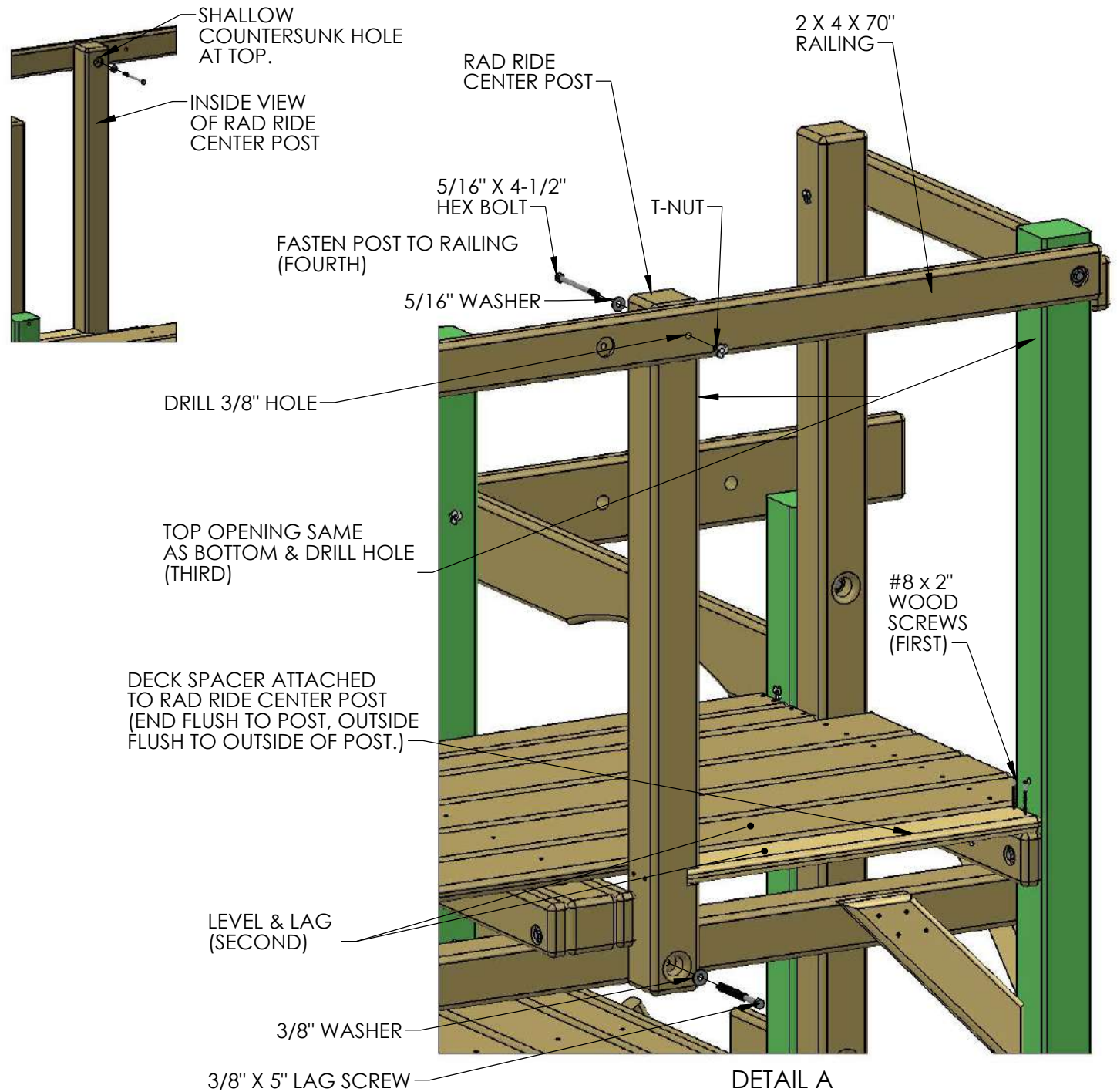

DETAIL A
SCALE 1 : 9

STEP 35: UPPER LEVEL REAR DECK SPACER

1: PLACE THE 5/4 X 4 X 35-1/2" REAR DECK SPACER ON TOP OF THE DECK SUPPORTS. THE END SHOULD BE FLUSH TO THE CORNER POST. THE OUTSIDE OF THE DECK SPACER SHOULD BE FLUSH TO THE OUTSIDE OF THE CORNER POST/CENTER POST.

2: FASTEN THE REAR DECK SPACER TO THE DECK SUPPORTS WITH FOUR #8 X 2" WOOD SCREWS.

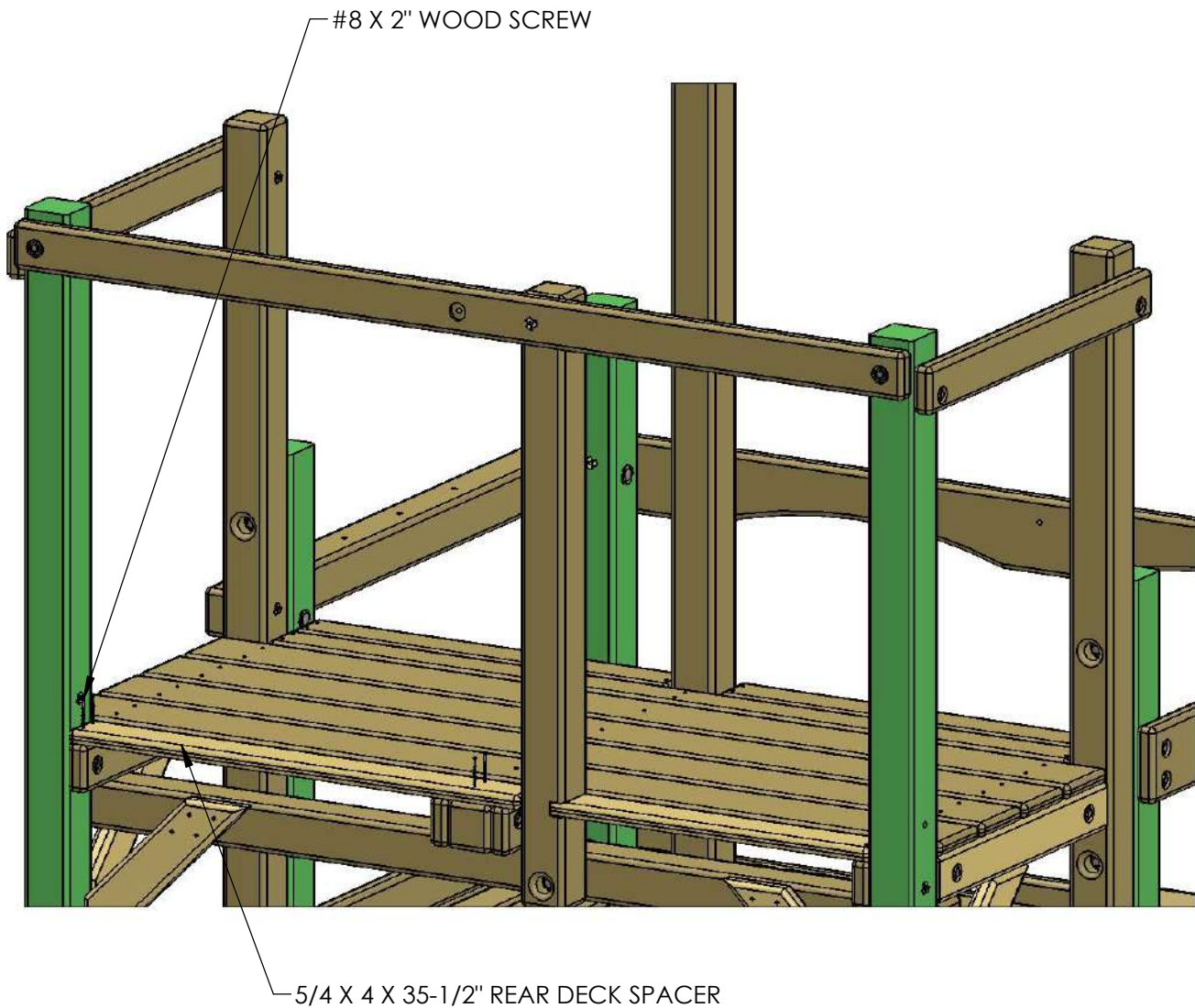

STEP 36: UPPER LEVEL CENTER POST

1: PLACE THE 4 X 4 X 69-3/4" CENTER LAG POST UPPER LEVEL AGAINST THE 4 X 4 X 71-7/8" REAR CENTER POST LOWER LEVEL. FLUSH THE SIDES OF THE POSTS TOGETHER.

2: ATTACH THE 4 X 4 X 69-3/4" CENTER LAG POST UPPER LEVEL TO THE 4 X 4 X 71-7/8" REAR CENTER POST LOWER LEVEL WITH 3/8" X 5" LAG SCREWS AND 3/8" WASHERS.

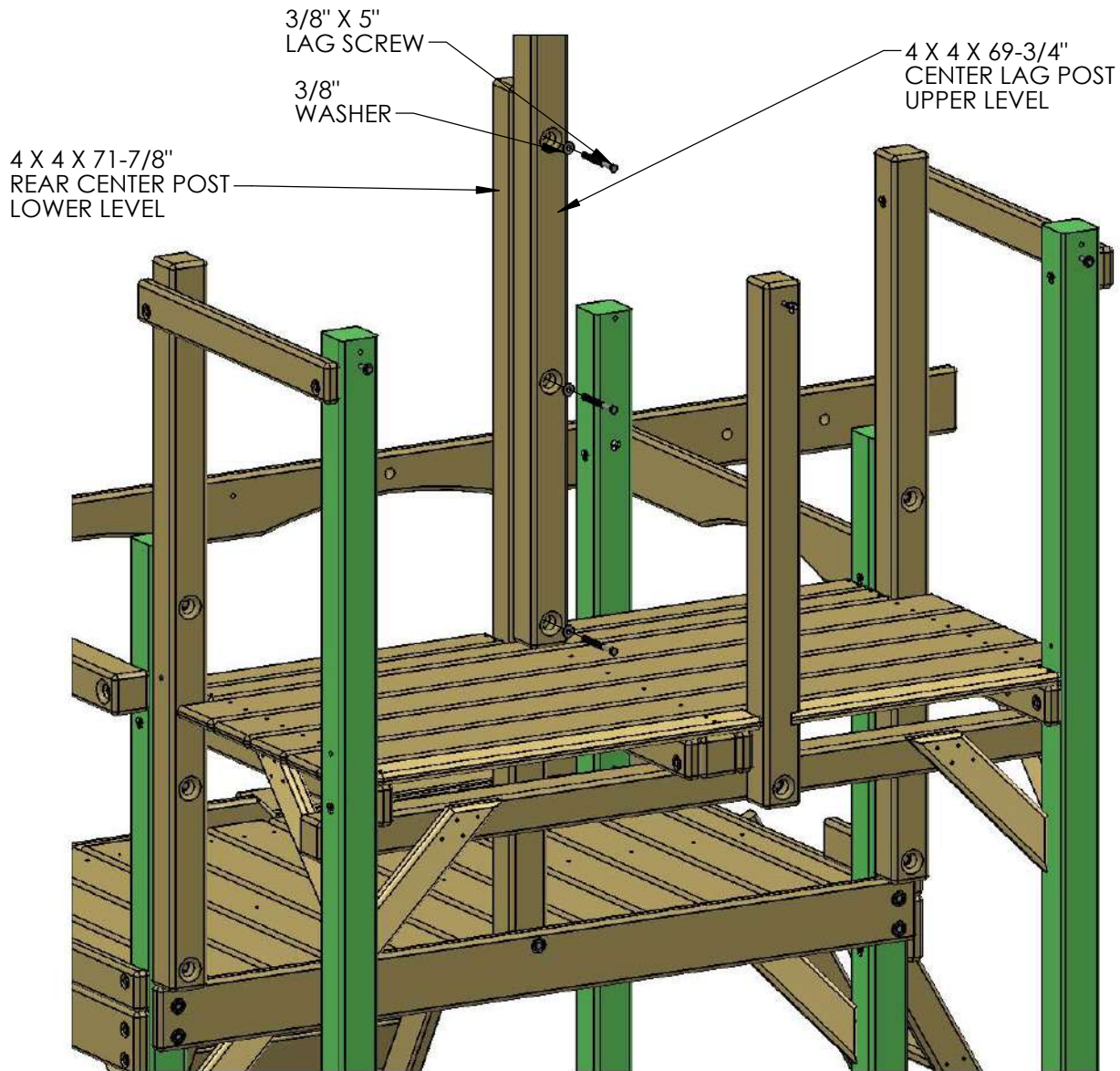

STEP 37: RAILING

1: PLACE THE 2 X 4 X 70" REAR TOP PANEL BOARD (RAILING) OFFSET UP INSIDE THE LAG POSTS OF THE UPPER LEVEL.

2: THE TOP OF THE RAILING SHOULD BE 33" ABOVE THE DECK BOARDS.

3: ATTACH THE RAILING TO THE LAG POSTS AND UPPER LEVEL CENTER POST WITH 5/16" X 3-1/2" LAG SCREWS WITH 5/16" WASHERS.

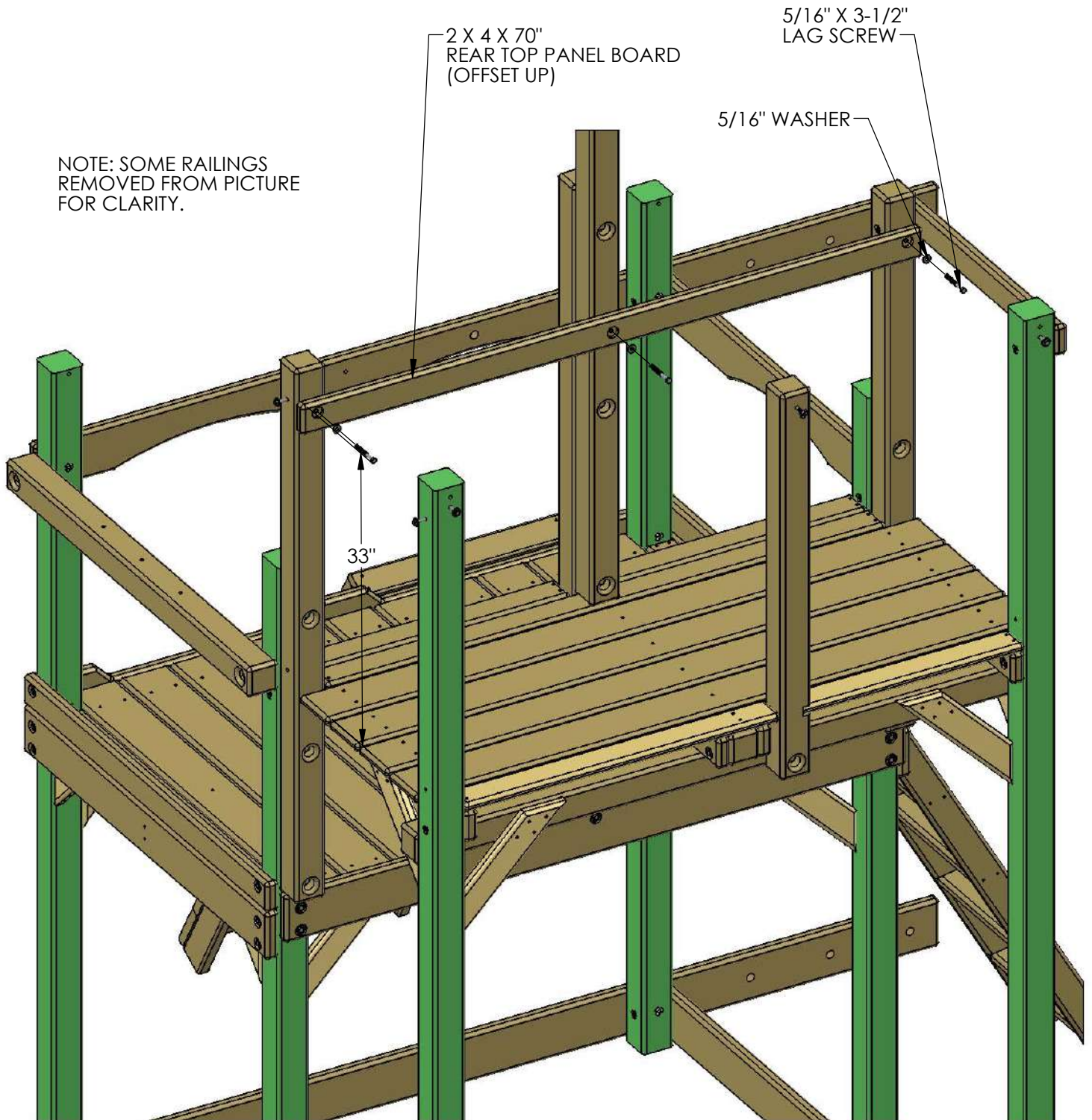

STEP 38: RADICAL RIDE TUBE SLIDE

- 1: ASSEMBLE THE RADICAL RIDE TUBE SLIDE ACCORDING TO THE DIRECTIONS INCLUDED WITH THE SLIDE.
- 2: PLACE THE SLIDE FACEPLATE AT THE OPENING AT THE REAR OF THE PLAY SET. THE SIDE OF THE FACE PLATE SHOULD BE 3/4" AWAY FROM THE CORNER POST SIDE.
- 3: THE BOTTOM OF THE SLIDE OPENING SHOULD BE FLUSH WITH THE UPPER LEVEL DECK.
- 4: ATTACH THE SLIDE FACE PLATE TO THE CORNER POST AND RAD RIDE CENTER POST WITH 5/16" X 3-1/2" LAG SCREWS AND 5/16" WASHERS. NOTE THERE WILL NOT BE A LAG SCREW ON THE BOTTOM ON THE RAD RIDE CENTER POST SIDE.

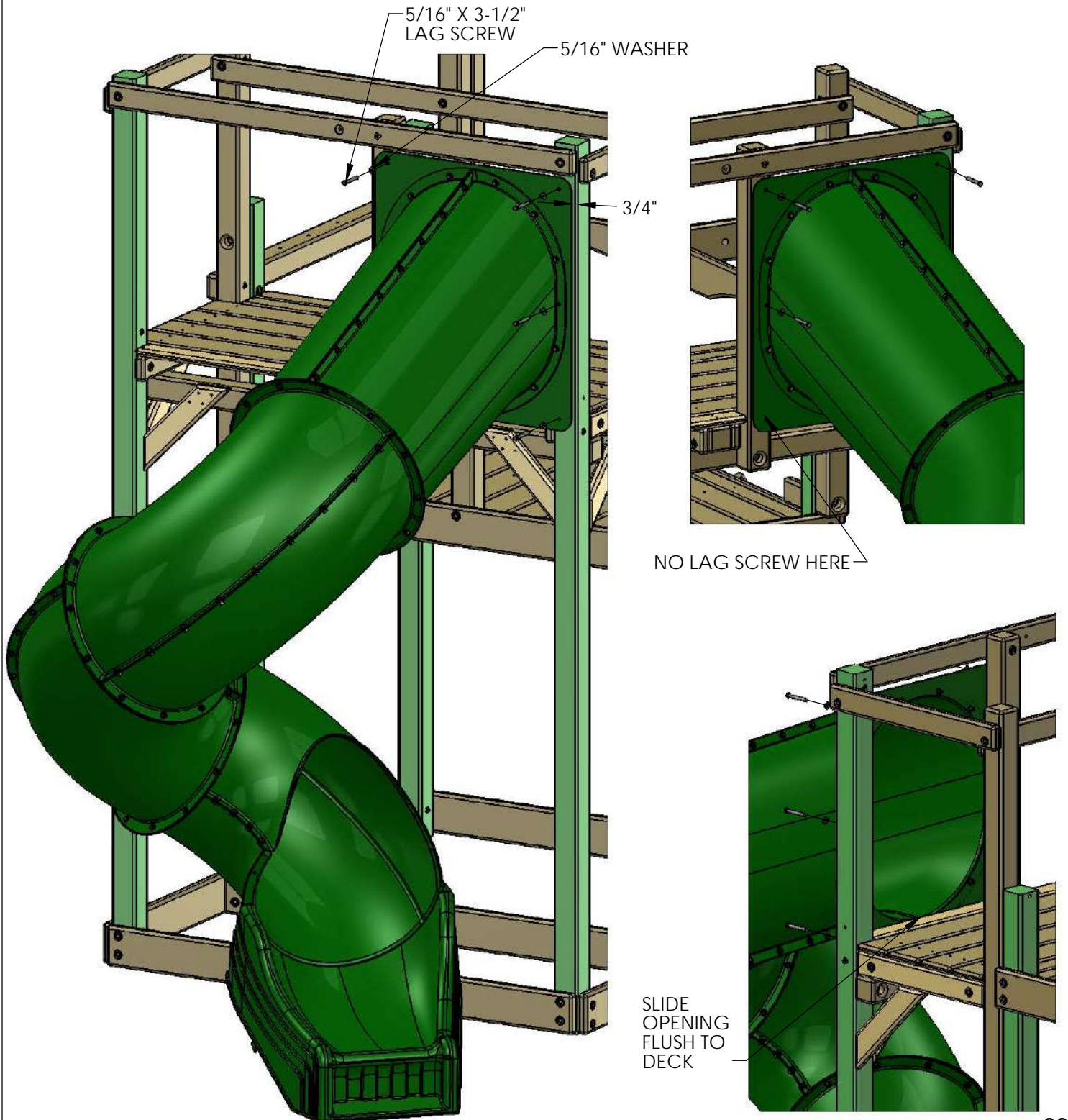

STEP 39: UPPER LEVEL BOTTOM PANEL BOARDS

1: PLACE THE 2 X 6 X 30-7/16" SIDE BOTTOM PANEL BOARD (OFFSET UP) ON THE SWING BEAM SIDE (RIGHT SIDE) OF THE PLAYSET. ATTACH THE TOP HOLES OF THE BOARD TO THE POSTS WITH 5/16" X 4-1/2" HEX BOLTS AND 5/16" WASHERS. ATTACH THE BOTTOM HOLES WITH 5/16" X 3-1/2" LAG SCREWS AND 5/16" WASHERS.

2: PLACE THE 2 X 6 X 42-1/2" REAR BOTTOM PANEL BOARD (OFFSET DOWN) ON THE BACK SIDE OF THE UPPER LEVEL. MAKE THE TOP OF THE BOARD EVEN WITH THE TOP OF THE SIDE BOTTOM PANEL BOARD INSTALLED IN SUBSTEP 1. FASTEN THE REAR BOTTOM PANEL BOARD TO THE POSTS WITH 5/16" X 3-1/2" LAG SCREWS AND 5/16" WASHERS.

3: FILL THE CORNER POST HOLE ON BOTH SIDES WITH A BLACK PLASTIC PLUG AND A DAB OF CLEAR SILICONE.

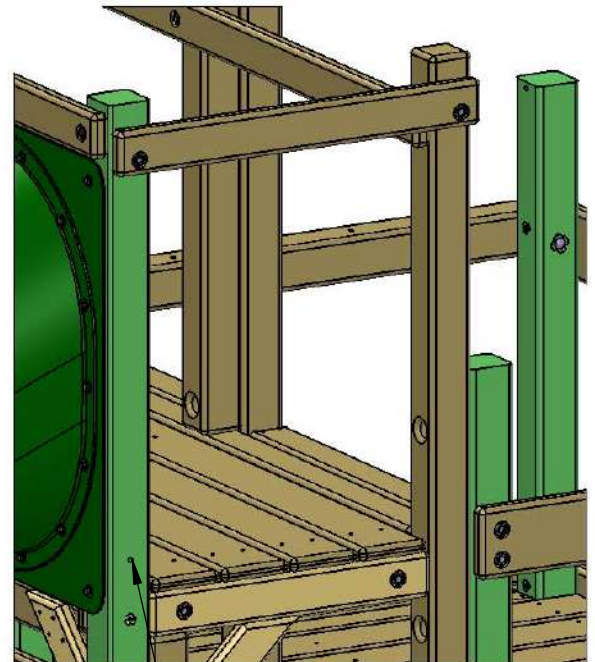
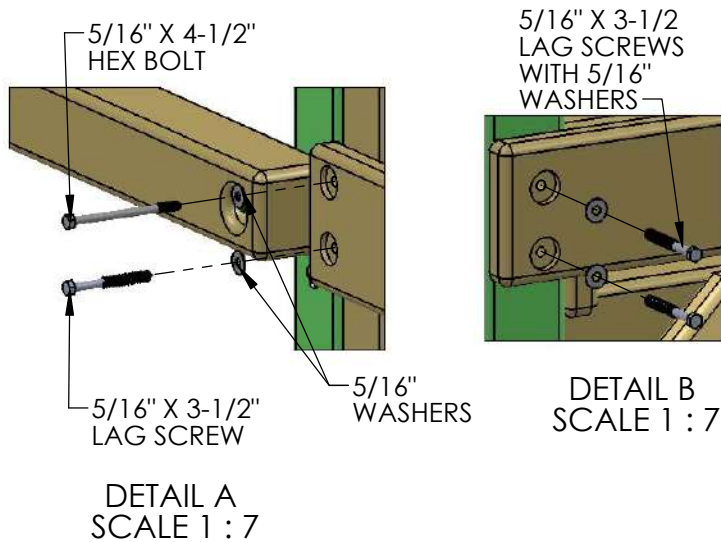

FILL THIS HOLE WITH BLACK PLASTIC PLUGS AND A DAB OF SILICONE ON BOTH SIDES.

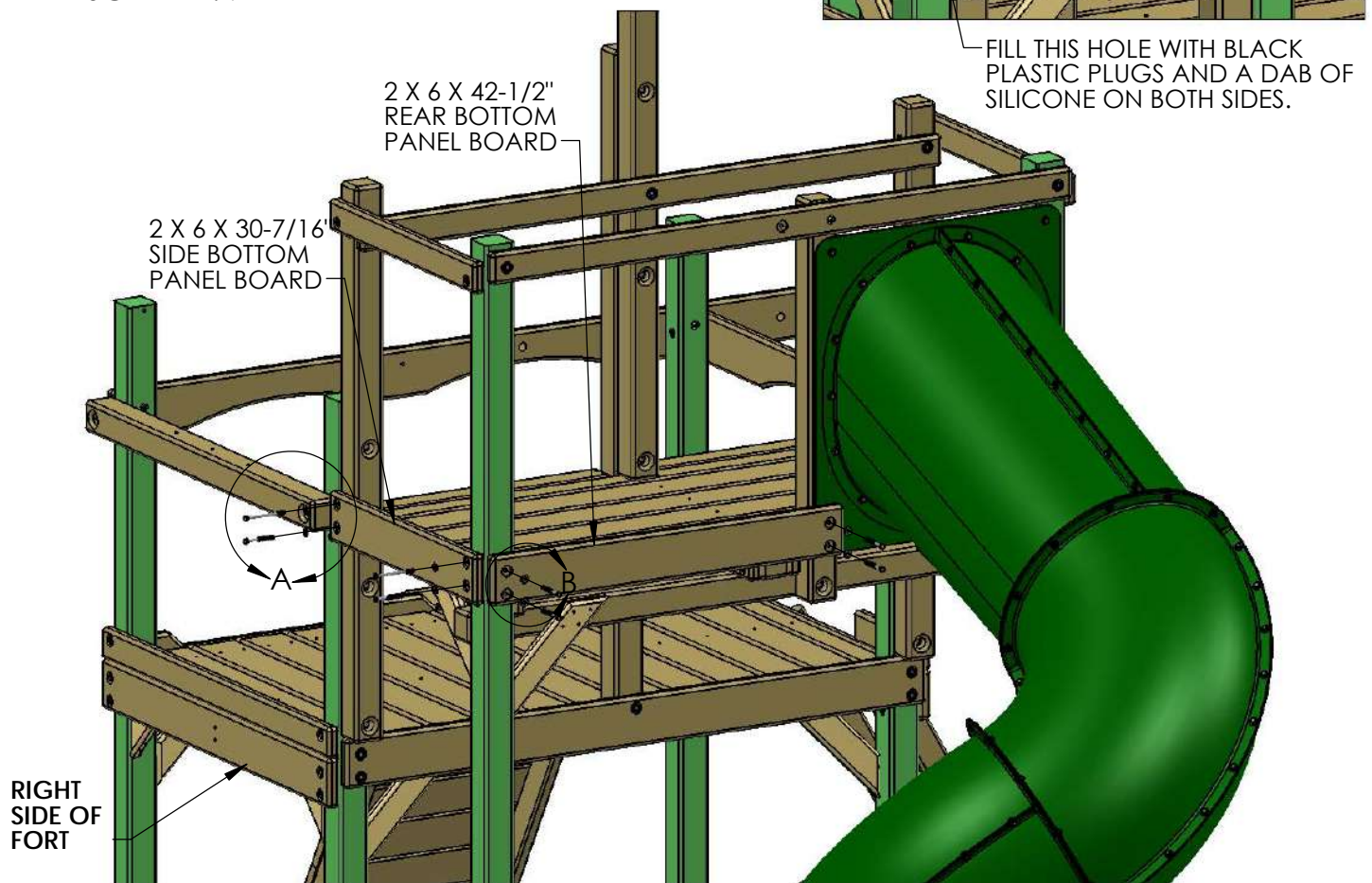

STEP 40: UPPER LEVEL REAR CENTER POST

1: PLACE THE 2 X 4 X 69-5/8" UPPER LEVEL REAR CENTER POST AGAINST THE REAR RAILING ON THE UPPER LEVEL. HAMMER A T-NUT INTO THE TOP HOLE IN THE UPPER LEVEL REAR CENTER POST. LINE UP THE HOLE IN THE UPPER LEVEL REAR CENTER POST WITH THE HOLE IN THE REAR RAILING.

2: ATTACH THE UPPER LEVEL CENTER POST TO THE RAILING AT THE TOP WITH A 5/16" X 2-1/2" HEX BOLT WITH A 5/16" WASHER.

3: SQUARE THE UPPER LEVEL CENTER POST TO THE DECK AND ATTACH THE BOTTOM OF THE POST TO THE REAR BOTTOM PANEL BOARD WITH TWO #8 X 2-1/2" WOOD SCREWS.

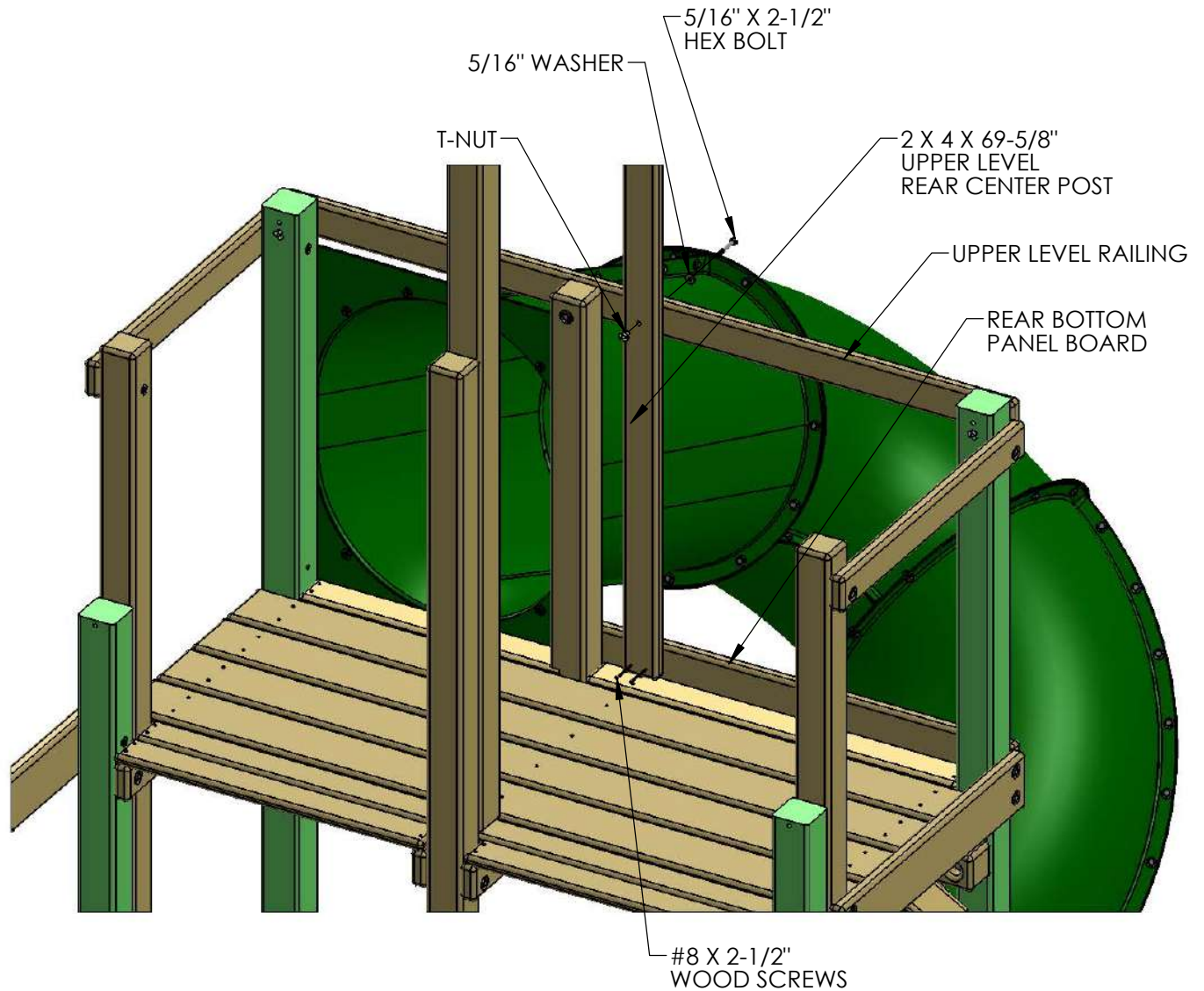

STEP 41: UPPER LEVEL PANEL SLATS

1: 5/4 X 3 X 34-1/2" PANEL SLATS WILL BE INSTALLED ON THE RIGHT AND REAR-RIGHT SIDES OF THE PLAY SET. THE PANEL SLATS WILL BE INSTALLED ON THE INSIDE OF THE BOTTOM PANEL BOARDS AND RAILINGS.

2: SPACE THE PANEL SLATS IN THE OPENINGS AS SHOWN BELOW. ATTACH EACH PANEL SLAT WITH TWO #8 X 2" WOOD SCREWS.

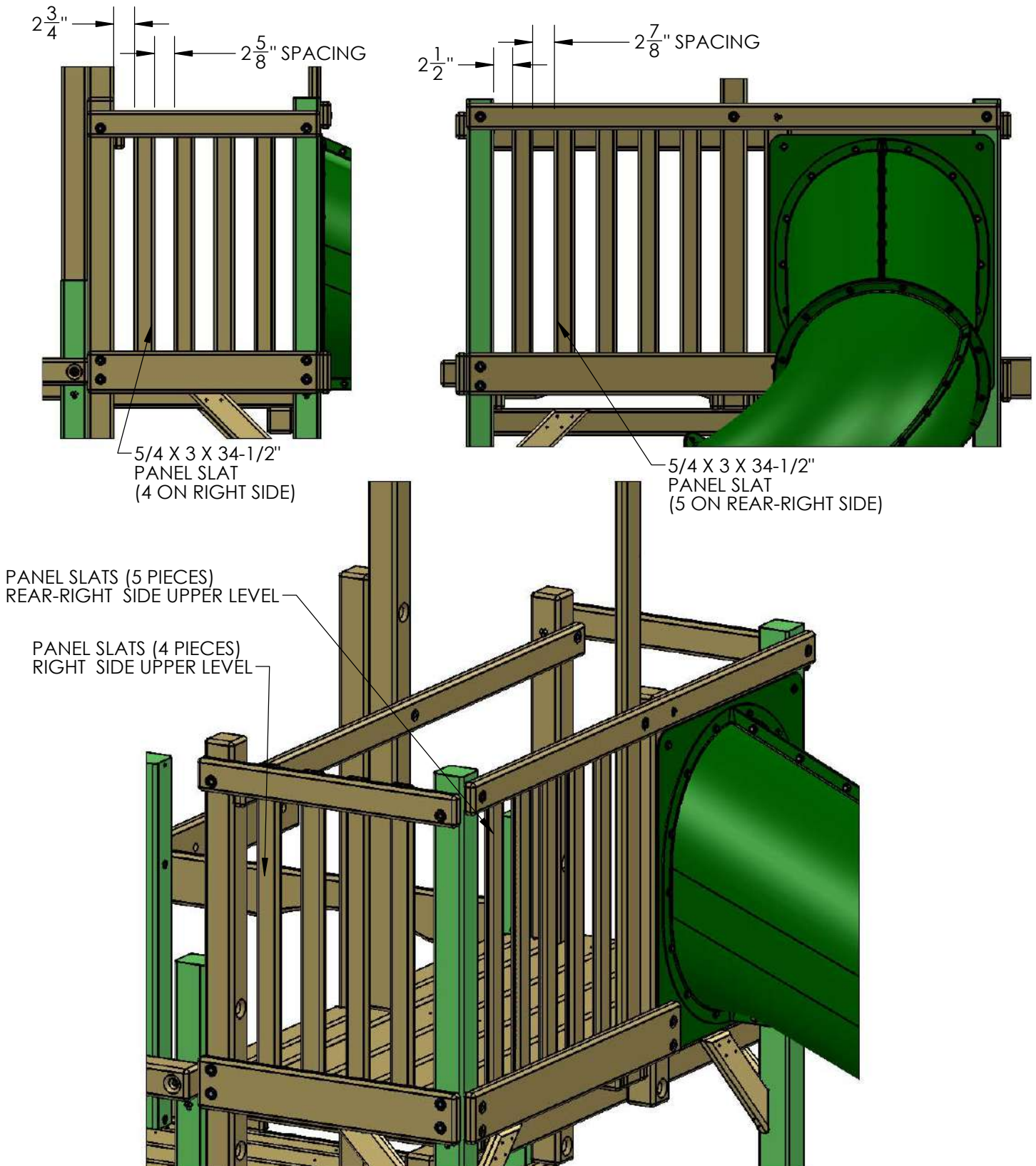

STEP 42: LOWER LEVEL FRONT CENTER TARP SUPPORT

1: LOCATE THE 4 X 4 X 72" CENTER TARP SUPPORT. PLACE THE 4 X 4 X 72" CENTER TARP SUPPORT CENTERED BEHIND THE HOLE IN THE ROPE LADDER SUPPORT.

2: HAMMER A T-NUT INTO THE HOLE IN THE BACK SIDE OF THE CENTER POST. FASTEN THE CENTER TARP SUPPORT TO THE ROPE LADDER SUPPORT WITH A 5/16" X 4-1/2" HEX BOLT AND A 5/16" WASHER.

3: SQUARE THE CENTER TARP SUPPORT TO THE DECK. ATTACH THE CENTER TARP SUPPORT TO THE FRONT FACE BOARD WITH TWO #8 X 3" WOOD SCREWS FROM THE FRONT. GO UNDER THE FRONT DECK AND INSTALL THREE #8 X 3" WOOD SCREWS THROUGH THE CENTER DECK BOARD INTO THE BOTTOM OF THE CENTER TARP SUPPORT.

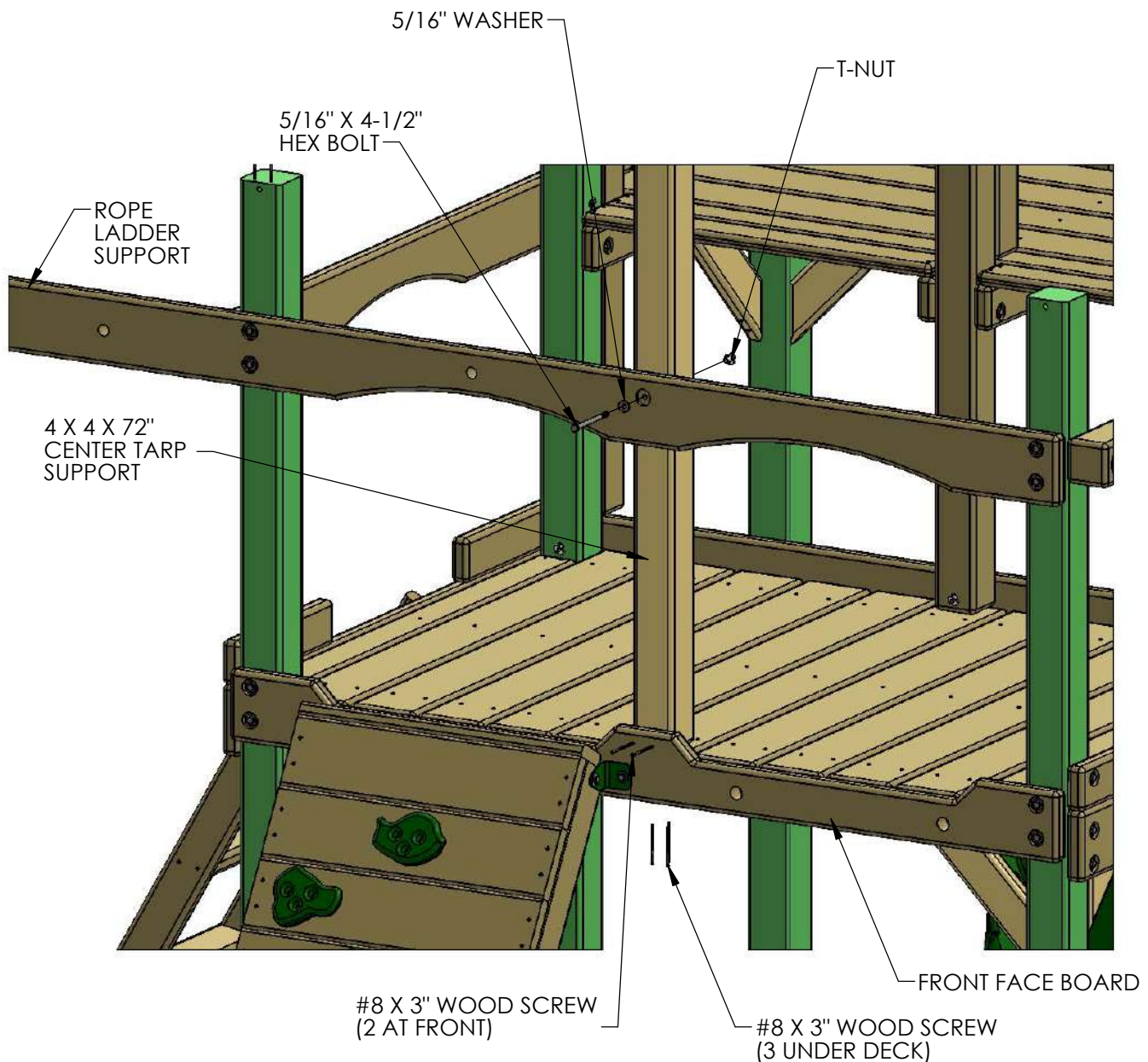

STEP 43: UPPER LEVEL STEPS

1: PLACE THE TOP OF ONE 2 X 4 X 70" UPPER LEVEL STEP FLUSH WITH THE TOP OF THE UPPER LEVEL DECK SPACERS. UPPER LEVEL STEPS HAVE THREE HOLES THAT ARE CENTERED.

2: ATTACH THE UPPER LEVEL STEP TO THE POSTS WITH THREE 5/16" X 3-1/2" LAG SCREWS AND THREE 5/16" WASHERS.

3: LEAVE A 3-3/8" GAP BETWEEN THE UPPER LEVEL STEP YOU JUST INSTALLED AND THE NEXT UPPER LEVEL STEP. ATTACH THE NEXT UPPER LEVEL STEP WITH THREE 5/16" X 3-1/2" LAG SCREWS AND THREE 5/16" WASHERS.

4: REPEAT SUBSTEP 3 TO INSTALL THE NEXT TWO UPPER LEVEL STEPS.

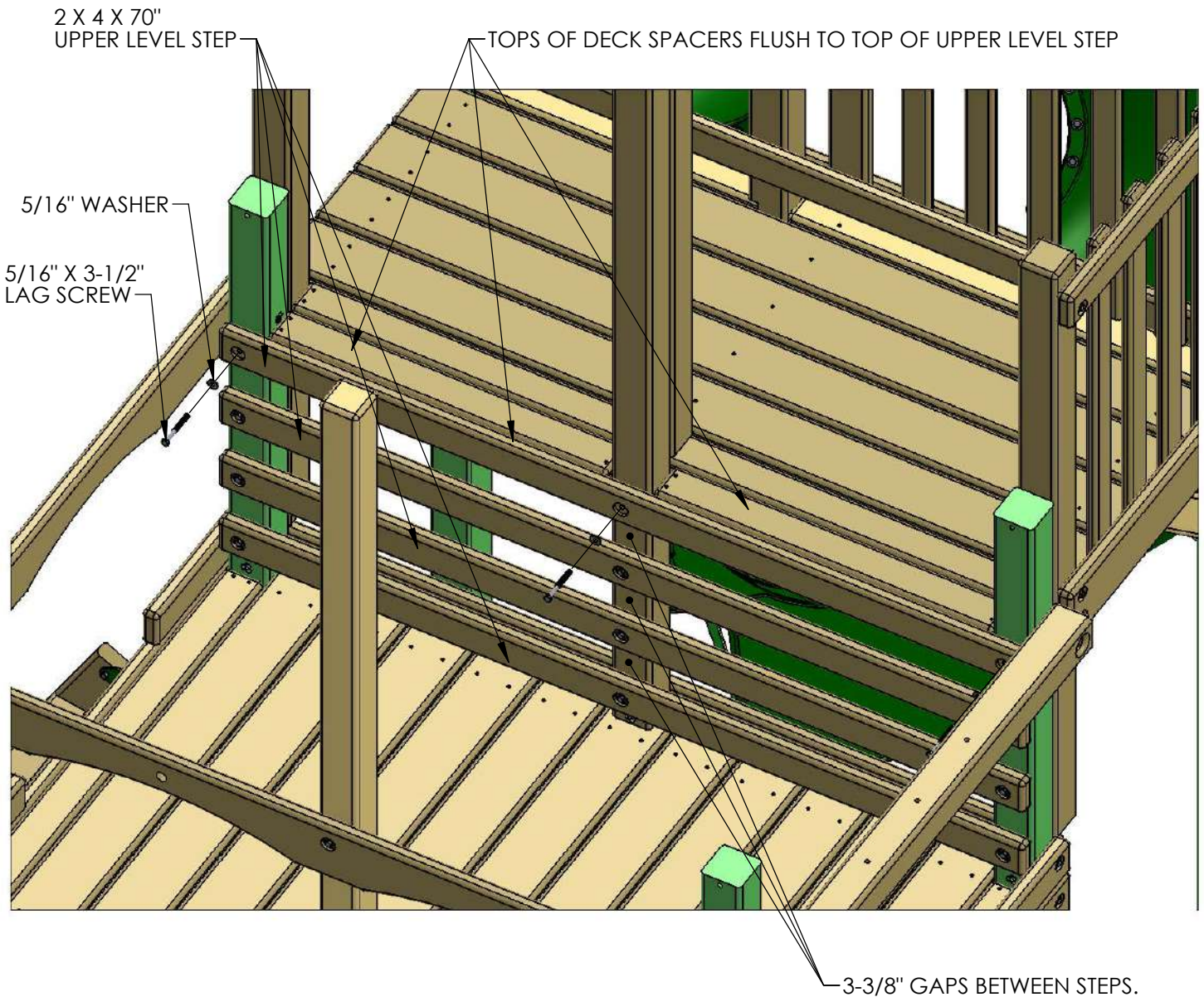

STEP 44: LOWER LEVEL PANEL SLATS

1: PLACE THE 5/4 X 3 X 28-1/4" PANEL SLATS INTO THE OPENINGS AS SHOWN BELOW. SPACE THE SLATS AS INDICATED BY THE DIMENSIONS SHOWN. THERE ARE FOUR SLATS ON THE LEFT SIDE, SIX SLATS ON THE RIGHT SIDE AND TWO SLATS ON THE FRONT OF THE LOWER LEVEL.

2: PLACE EACH SLAT AS SHOWN BELOW ON THE INSIDE OF THE PANEL BOARDS AND ATTACH EACH PANEL SLAT TO THE FORT WITH TWO #8 X 2" WOOD SCREWS.

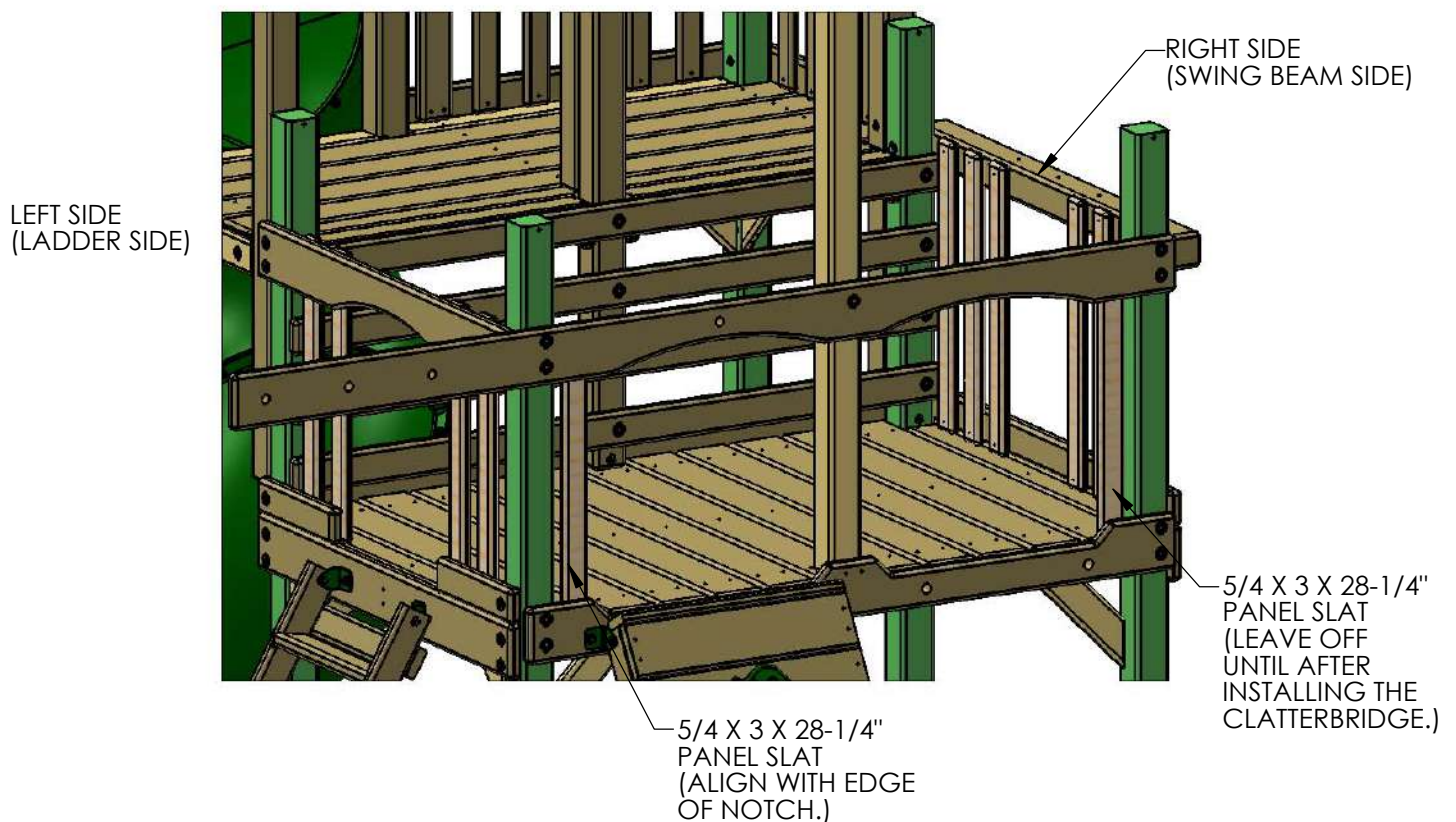
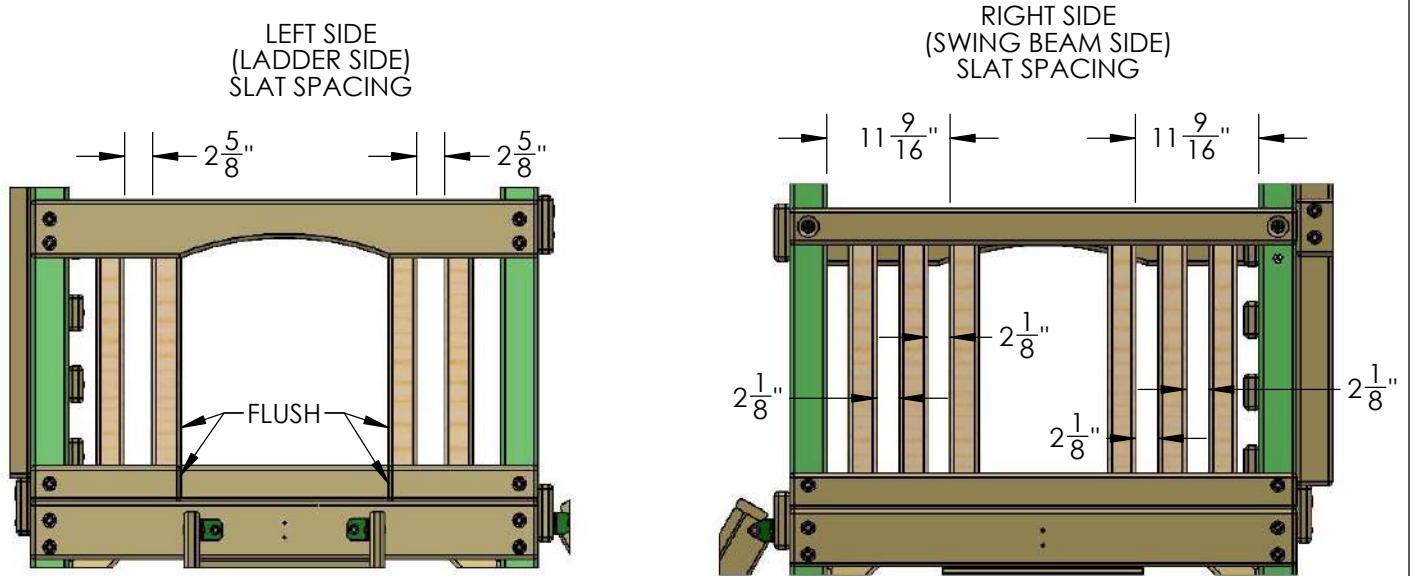

STEP 45: SWING BEAM PLATE

1: PLACE THE SWING BEAM PLATE ON TOP OF THE SWING BEAM MOUNT, LINING UP THE PILOT HOLES.

2: FASTEN THE SWING BEAM PLATE TO THE SWING BEAM MOUNT USING 3/8" X 3-1/2" CARRIAGE BOLTS ON TOP AND 3/8" LOCK NUTS WITH 3/8" WASHERS FROM UNDERNEATH. USE BOLT CAPS TO COVER ANY EXPOSED THREADS.

3: LEAVE THE MIDDLE HOLE EMPTY, IT WILL BE USED LATER.

4: IF NECESSARY USE LOCKING PLIERS TO HOLD CARRIAGE BOLTS IN PLACE WHEN INSTALLING.

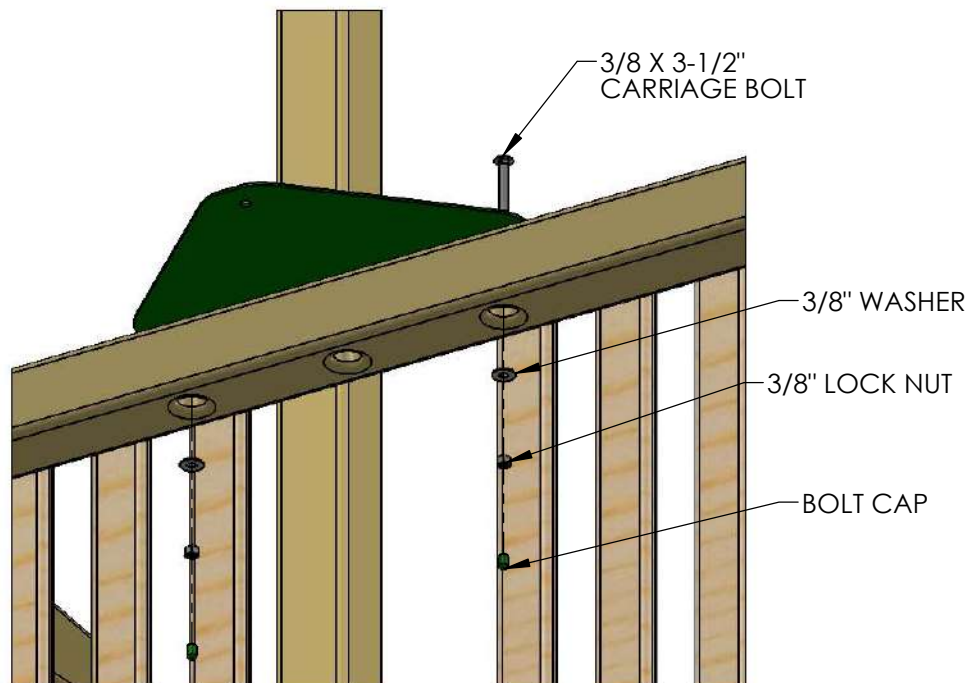
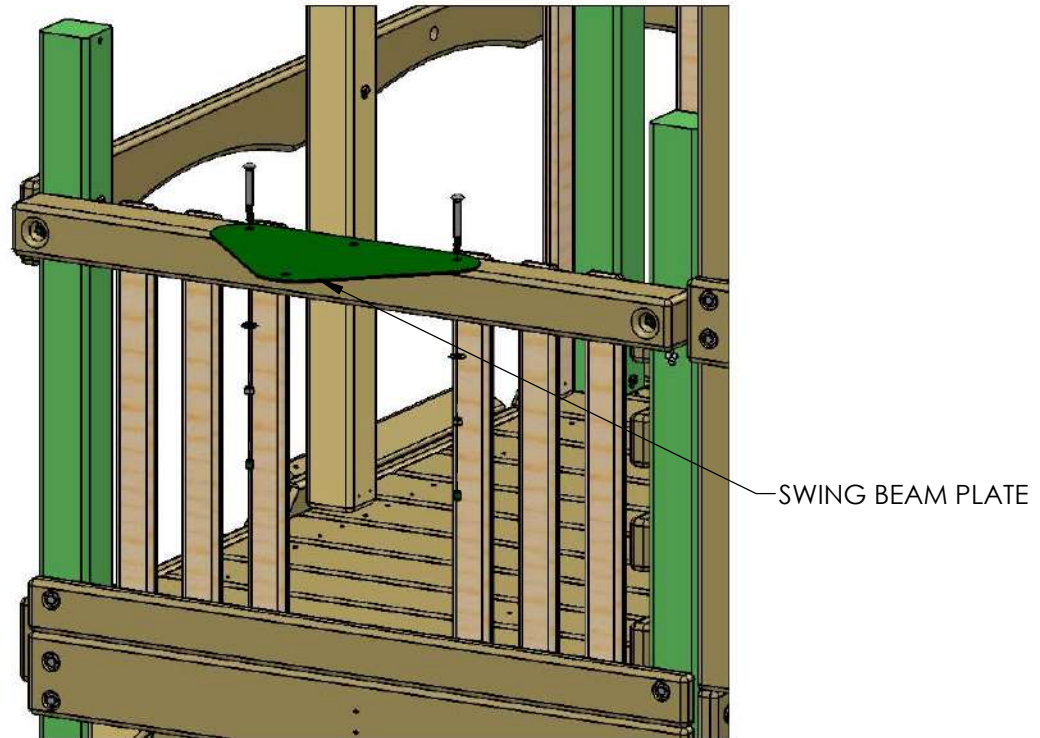

STEP 46: IRON DUCTILE SWING HANGERS

1: LINE UP THE HOLES OF THE IRON DUCTILE SWING HANGERS WITH THE HOLES IN THE SWING BEAM. IF YOUR BEAM IS BOWED SLIGHTLY PLACE THE BOW SIDE UP; THE SWING HANGERS WILL BE ON THE BOTTOM.

2: FASTEN EACH SWING HANGER TO THE SWING BEAM USING 7" CARRIAGE BOLTS WITH TORQUE WASHERS, AND 3/8" WASHERS WITH 3/8" LOCK NUTS.

3: PLACE BOLT CAPS OVER EXPOSED THREADS.

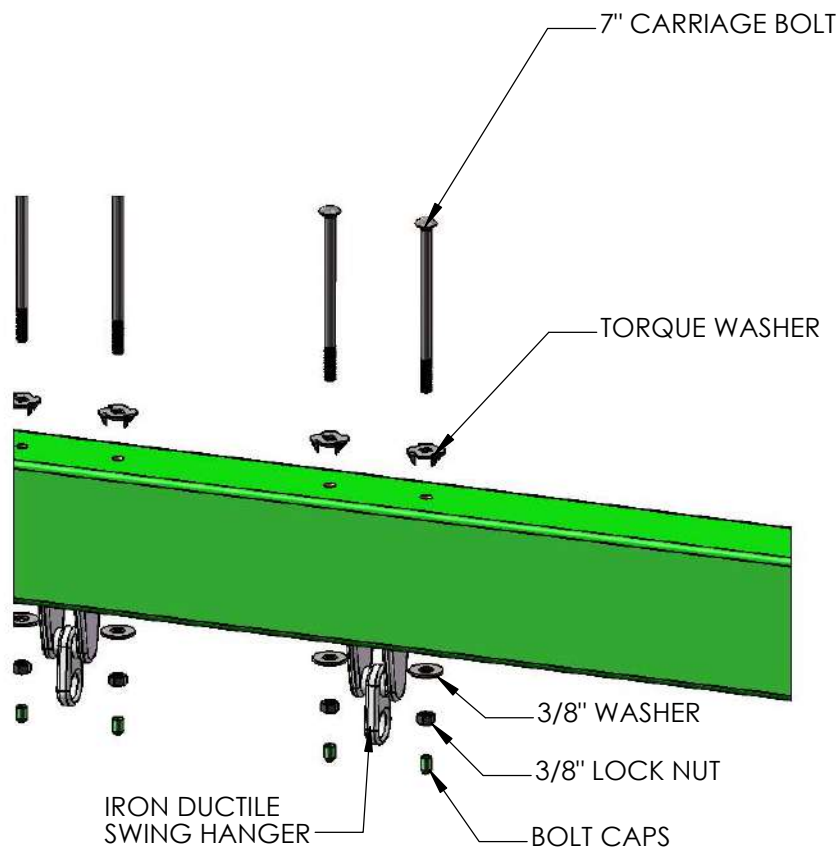
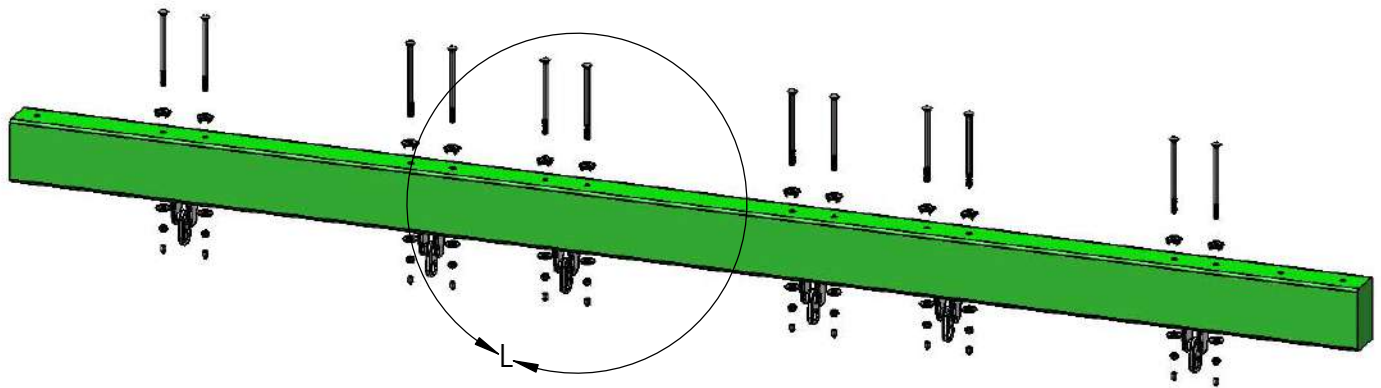

STEP 47: ATTACH SWING LEGS TO BRACKET

1: PLACE THE 4 X 4 X 108" SWING LEGS FLUSH TO THE TOP OF THE SWING LEG BRACKET.

2: FASTEN THE SWING LEGS TO THE SWING LEG BRACKET WITH 3/8 X 3-1/2" LAG SCREWS AND 3/8" WASHERS.

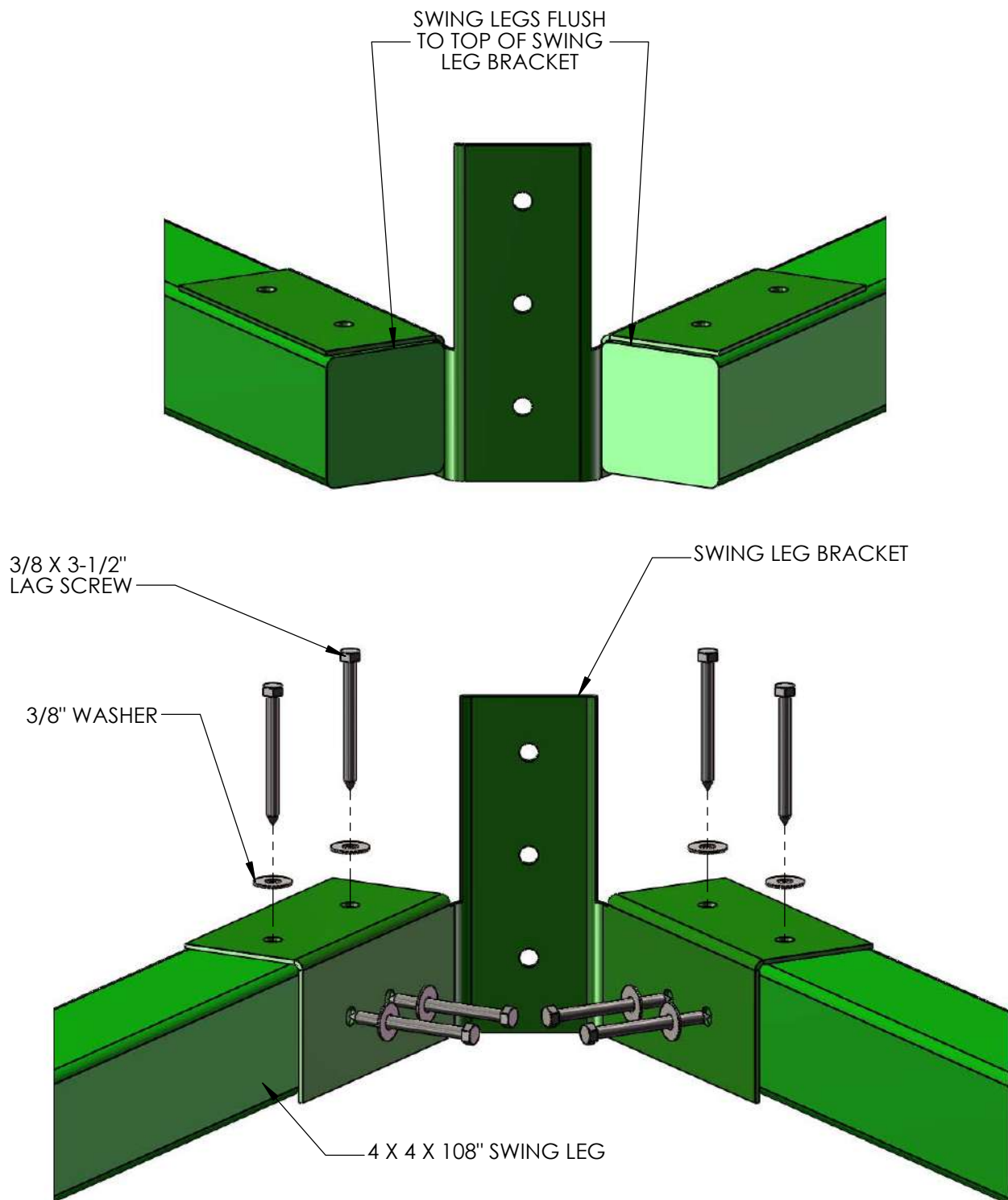

STEP 48: REST SWING BEAM ON FORT

1: REST THE SWING BEAM ASSEMBLY ON TOP OF THE UPPER RAILING BOARDS OF THE FORT.

2: THE END OF THE SWING BEAM WITH 2 HOLES SHOULD OVERHANG THE SWING BEAM SIDE OF THE FORT. IN THE NEXT STEP YOU WILL ATTACH THE SWING BEAM LEGS ONTO THIS END OF THE SWING BEAM.

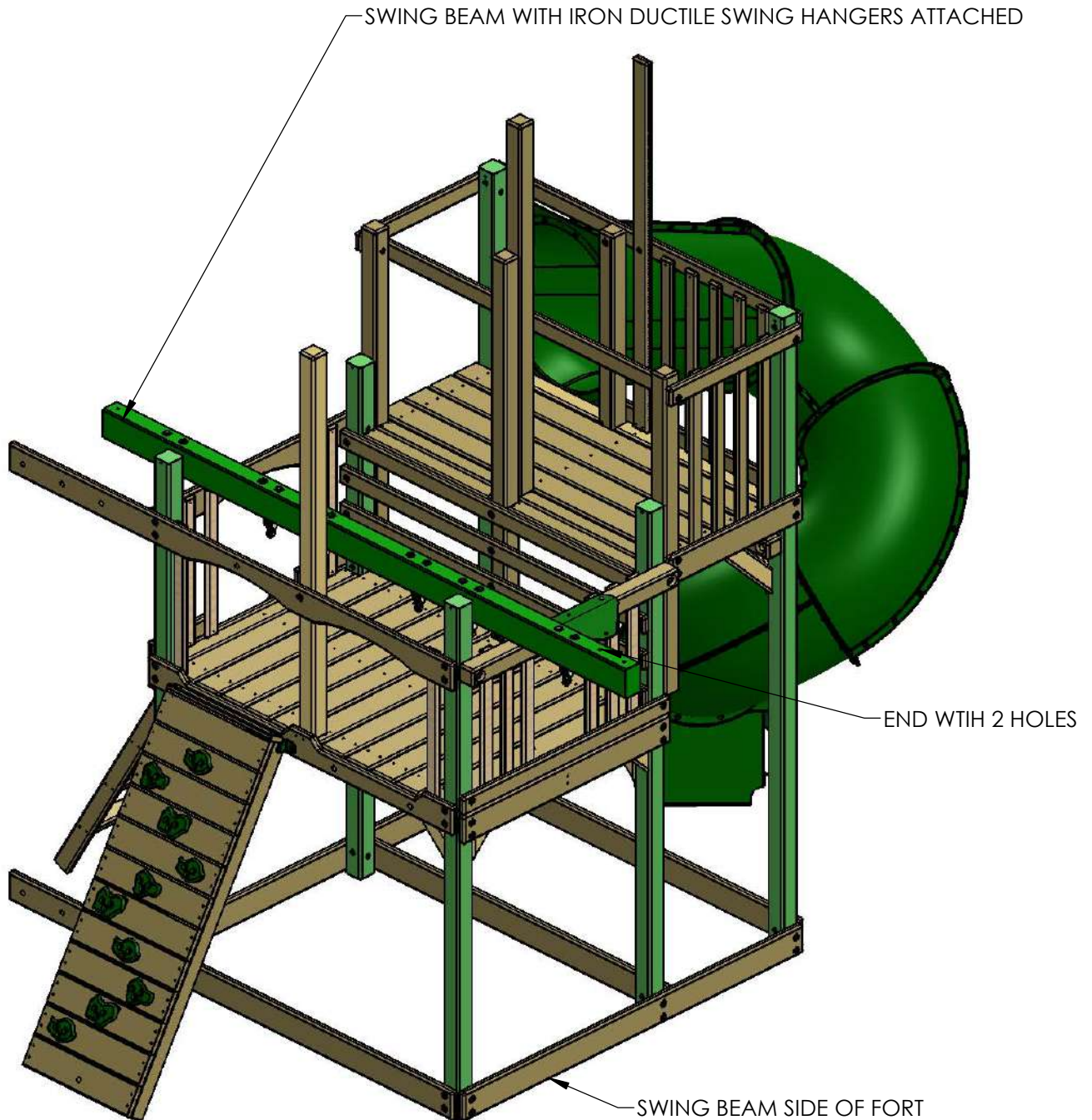

STEP 49: MOUNT SWING BEAM TO SWING BEAM LEGS

1: FASTEN THE SWING BEAM TO THE SWING BEAM BRACKET USING 7" CARRIAGE BOLTS WITH ONE TORQUE WASHER AND THE SUB BRACKET ON TOP OF THE SWING BEAM, AND 3/8" LOCK NUTS WITH 3/8" WASHERS FROM UNDERNEATH.

2: PREDRILL AN 11/64" HOLE THROUGH THE CENTER HOLE IN THE SWING LEG BRACKET. USE A 3/8 X 3-1/2" LAG SCREW WITH 3/8" WASHER FOR THE HOLE IN THE CENTER OF THE SWING BEAM BRACKET.

3: PLACE A BOLT CAP OVER ANY EXPOSED THREADS.

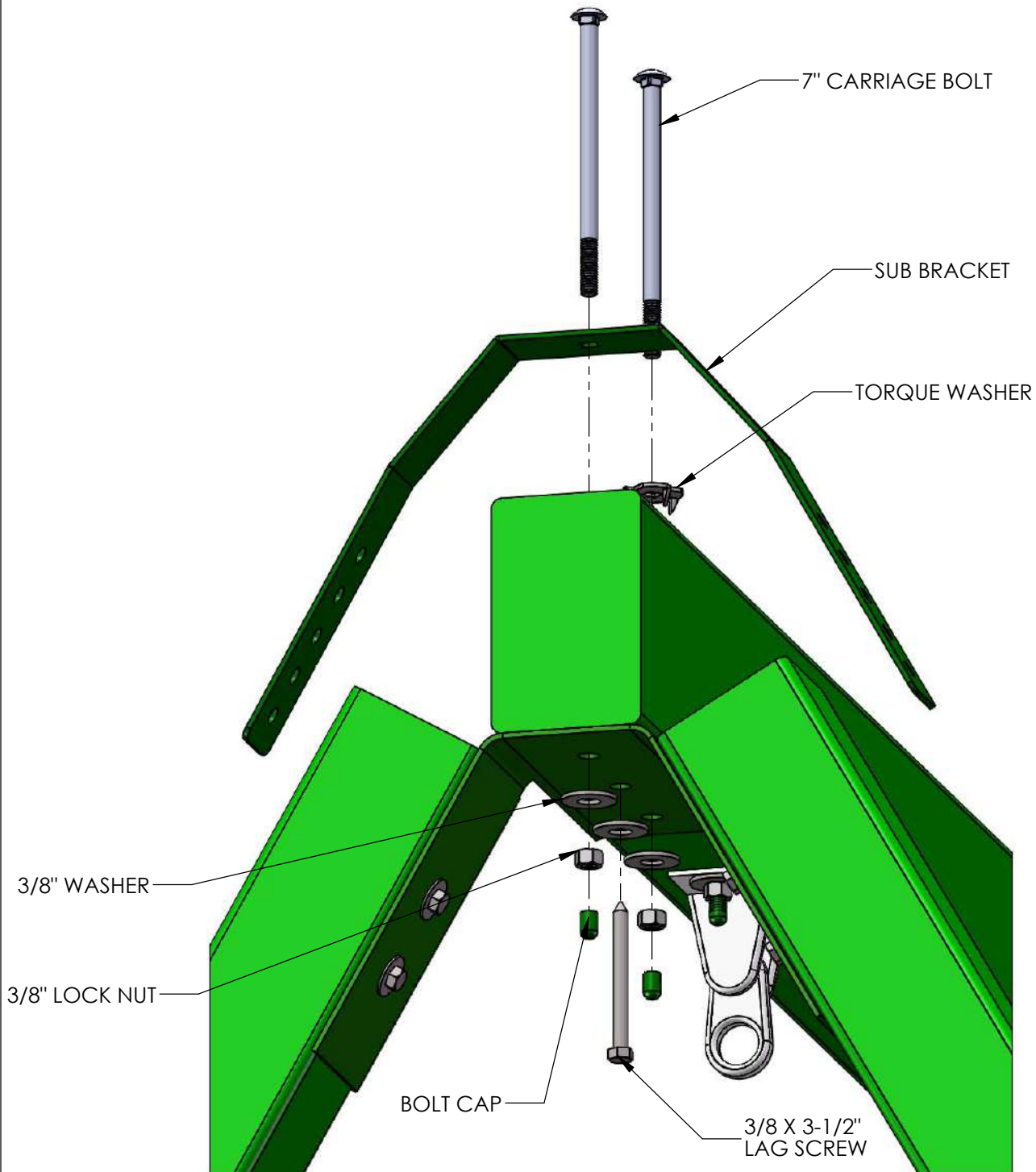

STEP 50: MOUNT SWING BEAM TO FORT

1: PLACE A 3/8" X 9" CARRIAGE BOLT THROUGH A TORQUE WASHER. INSERT THE CARRIAGE BOLT INTO THE HOLE AT THE END OF THE SWING BEAM OVER THE SWING BEAM MOUNT. ALIGN THE SQUARE SHANK OF THE CARRIAGE BOLT WITH THE SQUARE HOLE IN THE TORQUE WASHER. HAMMER THE CARRIAGE BOLT TO SET THE TORQUE WASHER INTO THE SWING BEAM.

2: ON THE BOTTOM SIDE OF THE SWING BEAM MOUNT ATTACH A 3/8" FLAT WASHER AND A 3/8" LOCK NUT ONTO THE END OF THE CARRIAGE BOLT. PLACE A BOLT CAP OVER ANY EXPOSED THREADS.

3: CENTER THE HOLE IN THE SWING BEAM PLATE ON THE SWING BEAM. PREDRILL A HOLE FOR THE LAG SCREW. INSTALL A 3/8" X 3-1/2" LAG SCREW WITH 3/8" WASHER INTO THE HOLE IN THE SWING BEAM PLATE.

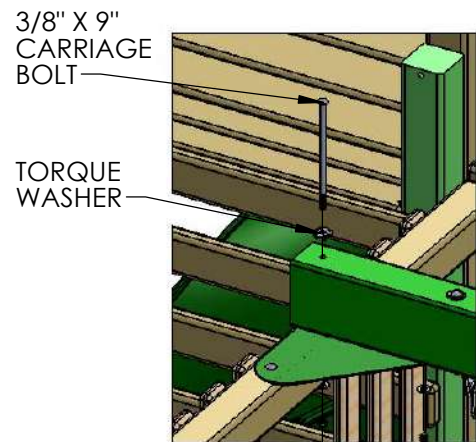
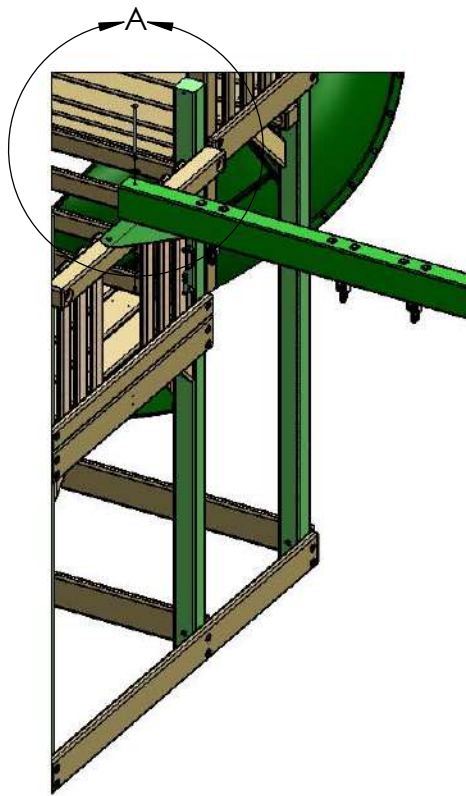

DETAIL A
SCALE 1 : 14

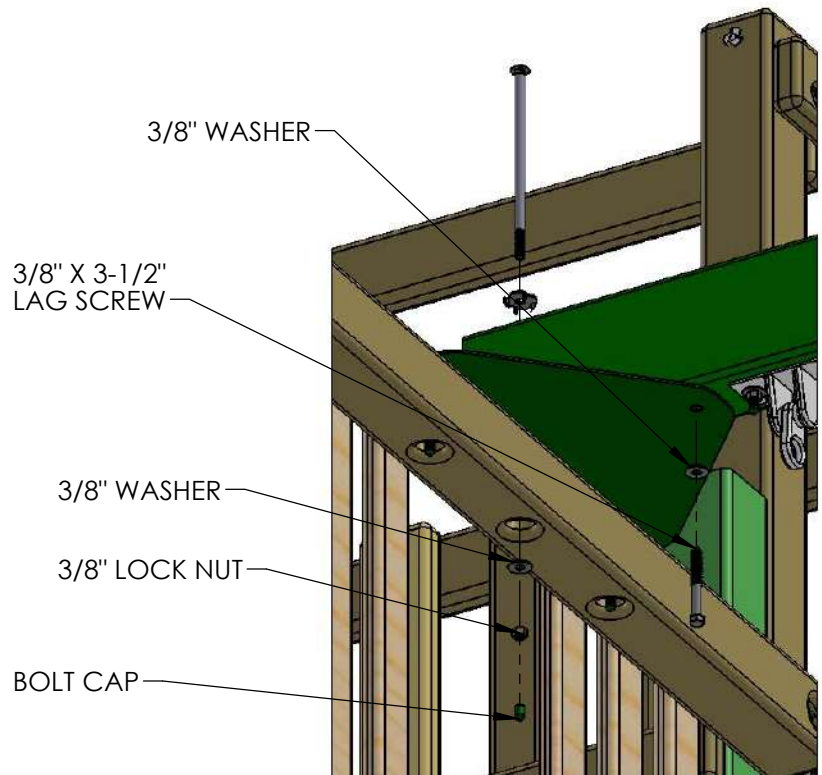

VIEW OF BOTTOM SIDE
OF SWING BEAM PLATE

STEP 51: LEVEL SWING BEAM

1: PLACE A LEVEL ON TOP OF THE SWING BEAM AND ADJUST THE BEAM LEGS IN OR OUT AS NEEDED TO MAKE THE SWING BEAM LEVEL.

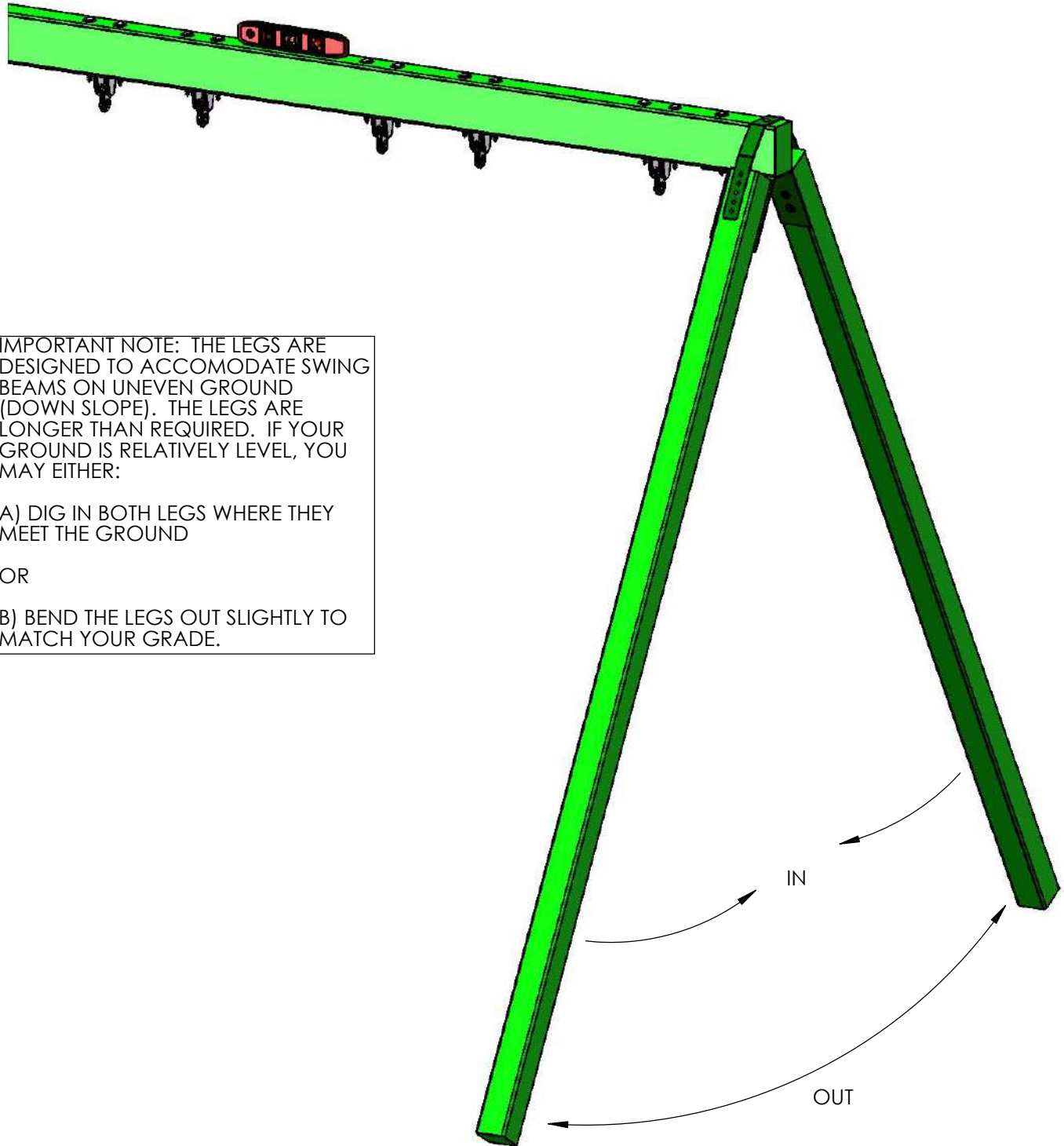

IMPORTANT NOTE: THE LEGS ARE DESIGNED TO ACCOMODATE SWING BEAMS ON UNEVEN GROUND (DOWN SLOPE). THE LEGS ARE LONGER THAN REQUIRED. IF YOUR GROUND IS RELATIVELY LEVEL, YOU MAY EITHER:

A) DIG IN BOTH LEGS WHERE THEY MEET THE GROUND

OR

B) BEND THE LEGS OUT SLIGHTLY TO MATCH YOUR GRADE.

STEP 52: SWING LEG CROSS-MEMBER

- 1: POSITION THE 2 X 4 X 58" SWING LEG CROSS-MEMBER AGAINST THE SWING BEAM LEGS.
- 2: LEVEL CROSS-MEMBER AND MARK THE LOCATION OF THE SECURING HOLES INSIDE THE CROSS-MEMBER HOLES.
- 3: USE 3/8 X 3-1/2" LAG SCREWS WITH 3/8" WASHERS TO SECURE THE CROSS-MEMBER TO THE SWING BEAM LEGS.
- 4: CHOOSE TWO HOLES IN THE SUB BRACKET THAT DO NOT INTERFERE WITH THE OTHER LAG SCREWS IN THE SWING LEG. DRILL 1 1/64" HOLES BY 2-1/2" DEEP INTO 2 HOLES IN THE SUB BRACKET. INSTALL TWO 3/8" X 2-1/2" LAG SCREWS WITH WASHERS. REPEAT ON THE OTHER SIDE OF THE SUB BRACKET.

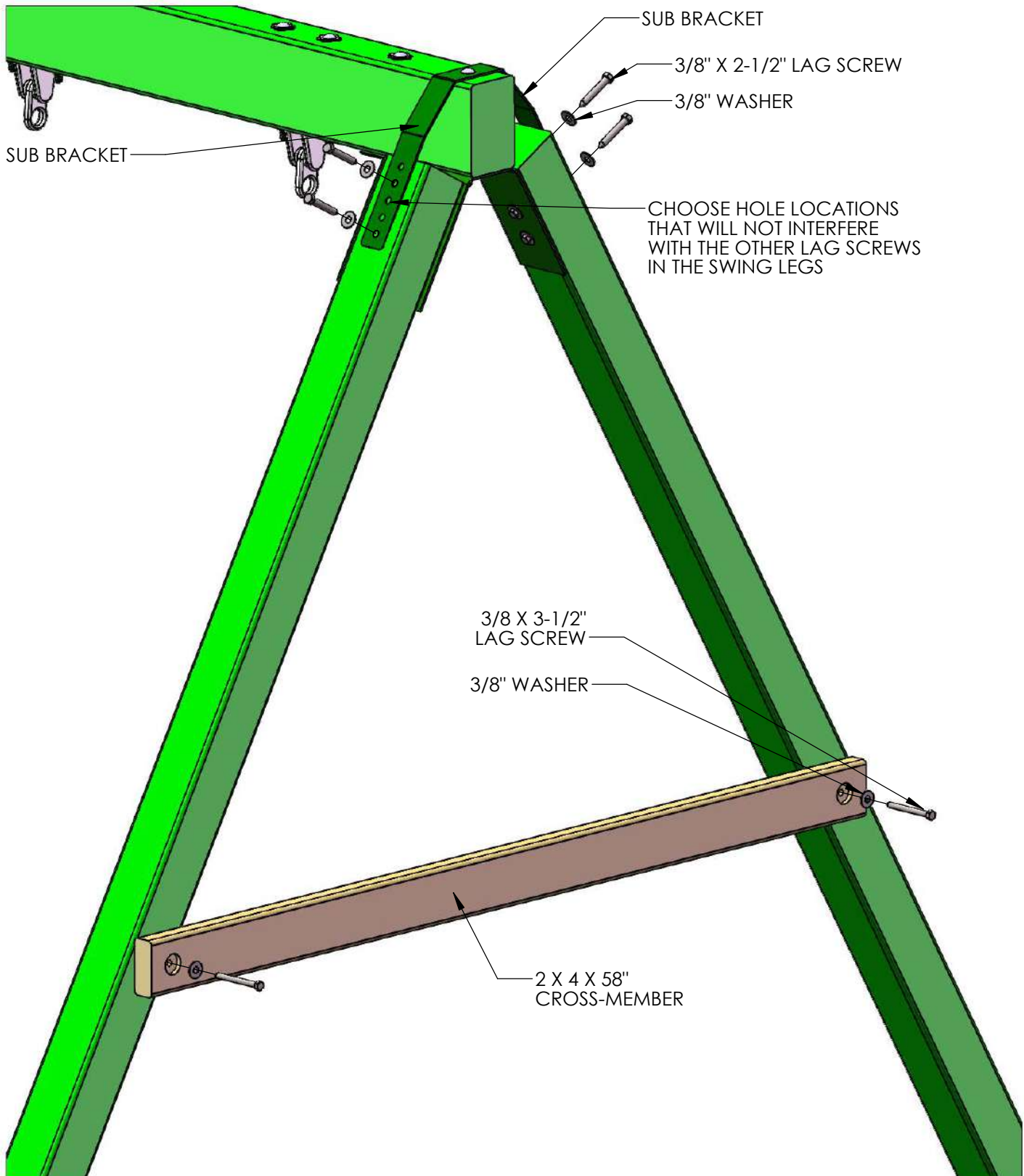

STEP 53: TARP BOARDS (LOWER/UPPER LEVEL)

1: LOCATE THREE 2 X 4 X 47-3/8" TARP BOARDS (LOWER LEVEL) AND THREE 2 X 4 X 30-1/2" TARP BOARD(UPPER LEVEL).

2: ATTACH EACH TARP BOARD TO THE TOP OF THE CORNER POSTS OR THE CENTER POSTS WITH #8 X 2-1/2" WOOD SCREWS.

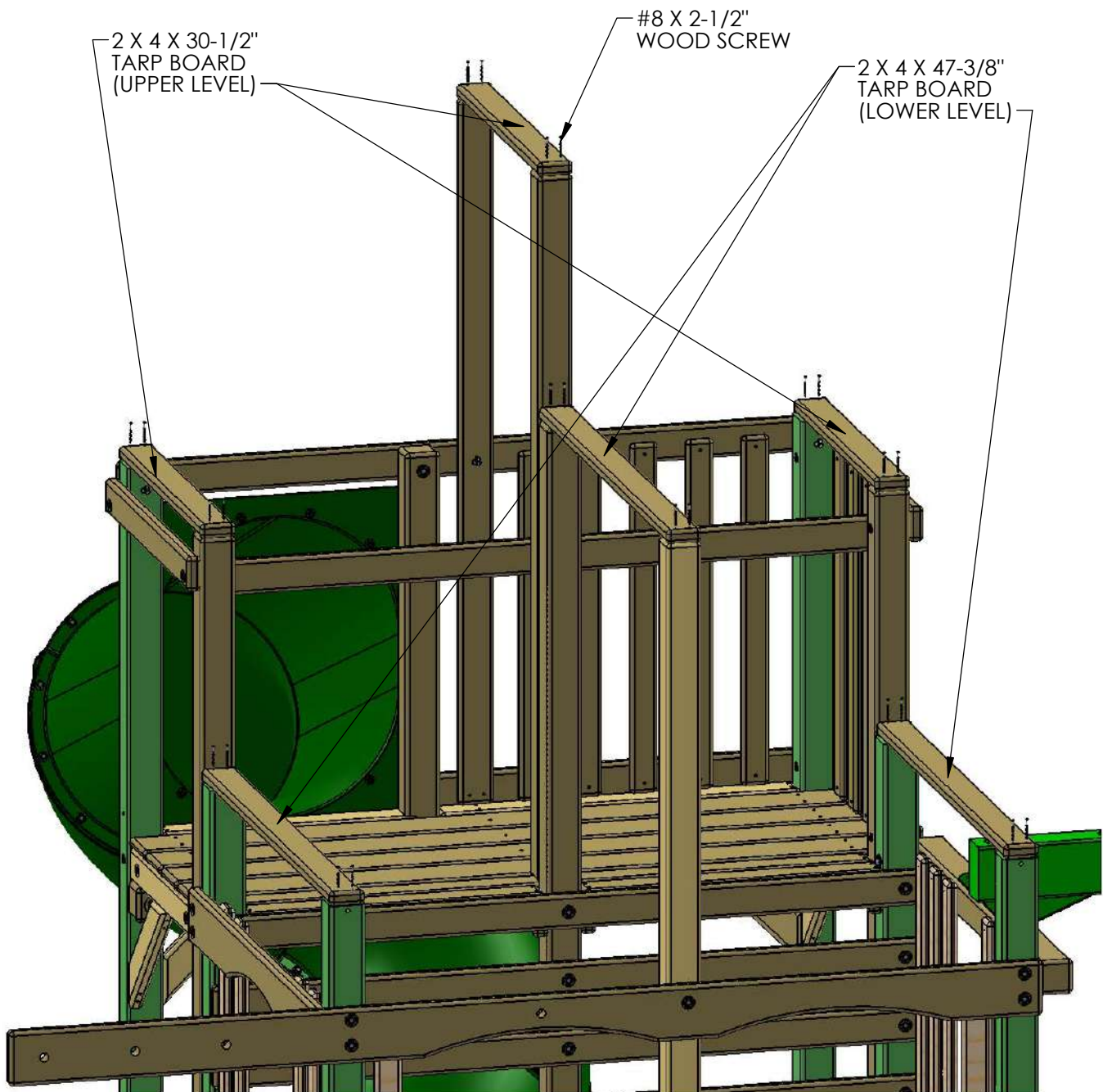

STEP 54: TARP (UPPER LEVEL)

1: PLACE THE TARP (UPPER LEVEL) ACROSS THE TARP BOARDS (UPPER LEVEL) WITH THE HEMS ON THE INSIDE.

2: FASTEN THE OUTSIDE CORNERS OF THE TARP TO THE SIDE OF THE TARP BOARD FIRST. ATTACH THE GROMMETS IN THE TARP TO THE TARP BOARD WITH #14 X 1-1/4" PAN HEAD SCREWS WITH 1/4" WASHERS. REPEAT FOR OTHER SIDE. (NOTE IF YOU WISH YOU MAY PREDRILL HOLES FOR THE PAN HEAD SCREW WITH A 1/8" DRILL BIT.)

3: NOW FOLD THE FLAP UNDER THE TARP BOARD AND FASTEN THE GROMMETS UNDER THE TARP BOARD WITH #14 X 1-1/4" PAN HEAD SCREWS WITH 1/4" WASHERS. REPEAT FOR OTHER SIDE. (NOTE IF YOU WISH YOU MAY PREDRILL HOLES FOR THE PAN HEAD SCREWS WITH A 1/8" DRILL BIT.)



NOTE: IF YOU WISH YOU MAY DRILL 1/8" PILOT HOLES IN THE TARP BOARD FOR THE PAN HEAD SCREWS.

TARP

FASTEN OUTSIDE GROMMETS FIRST TO THE SIDE OF THE TARP BOARD ON EACH SIDE WITH #14 X 1-1/4" PAN HEAD SCREWS AND 1/4" WASHERS. REPEAT FOR OTHER SIDE.

THEN FOLD THIS TAB UNDER THE TARP BOARD AND SECURE IT TO THE BOTTOM SIDE OF THE TARP BOARD WITH #14 X 1-1/4" PAN HEAD SCREWS AND 1/4" WASHERS. REPEAT FOR OTHER SIDE.

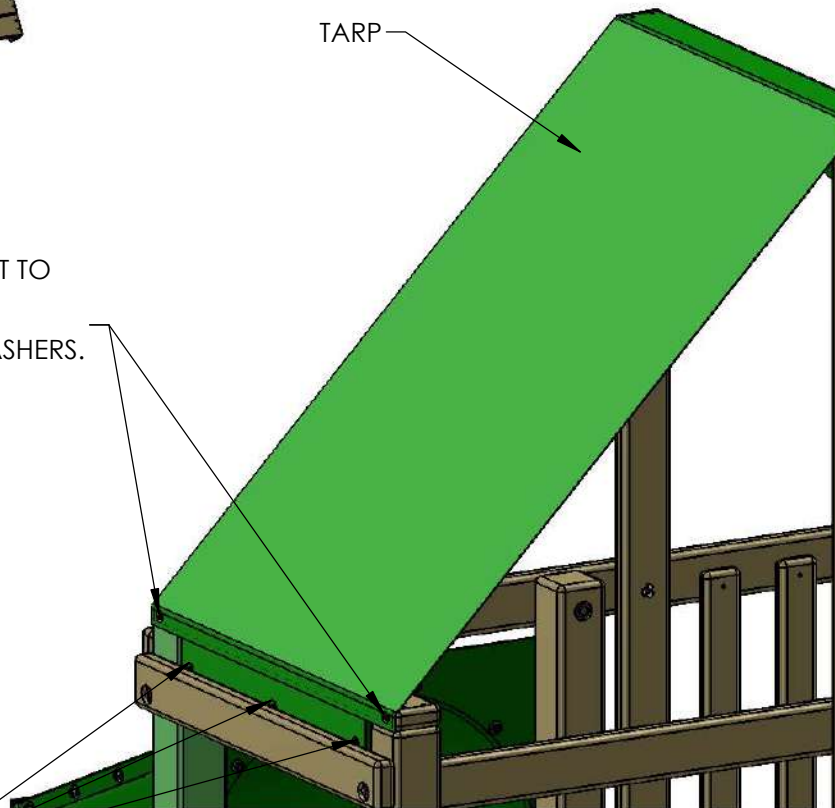

DETAIL A

STEP 55: TARP (LOWER LEVEL)

1: PLACE THE TARP (LOWER LEVEL) ACROSS THE TARP BOARDS (LOWER LEVEL) WITH THE HEMS ON THE INSIDE.

2: FASTEN THE OUTSIDE CORNERS OF THE TARP TO THE SIDE OF THE TARP BOARD FIRST. ATTACH THE GROMMETS IN THE TARP TO THE TARP BOARD WITH #14 X 1-1/4" PAN HEAD SCREWS WITH 1/4" WASHERS. REPEAT FOR OTHER SIDE. (NOTE IF YOU WISH YOU MAY PREDRILL HOLES FOR THE PAN HEAD SCREW WITH A 1/8" DRILL BIT.)

3: NOW FOLD THE FLAP UNDER THE TARP BOARD AND FASTEN THE GROMMETS UNDER THE TARP BOARD WITH #14 X 1-1/4" PAN HEAD SCREWS WITH 1/4" WASHERS. REPEAT FOR OTHER SIDE. (NOTE IF YOU WISH YOU MAY PREDRILL HOLES FOR THE PAN HEAD SCREWS WITH A 1/8" DRILL BIT.)



NOTE: IF YOU WISH YOU MAY DRILL 1/8" PILOT HOLES IN THE TARP BOARD FOR THE PAN HEAD SCREWS.

FASTEN OUTSIDE GROMMETS FIRST TO THE SIDE OF THE TARP BOARD ON EACH SIDE WITH #14 X 1-1/4" PAN HEAD SCREWS AND 1/4" WASHERS. REPEAT FOR OTHER SIDE.

THEN FOLD THIS TAB UNDER THE TARP BOARD AND SECURE IT TO THE BOTTOM SIDE OF THE TARP BOARD WITH #14 X 1-1/4" PAN HEAD SCREWS AND 1/4" WASHERS. REPEAT FOR OTHER SIDE.

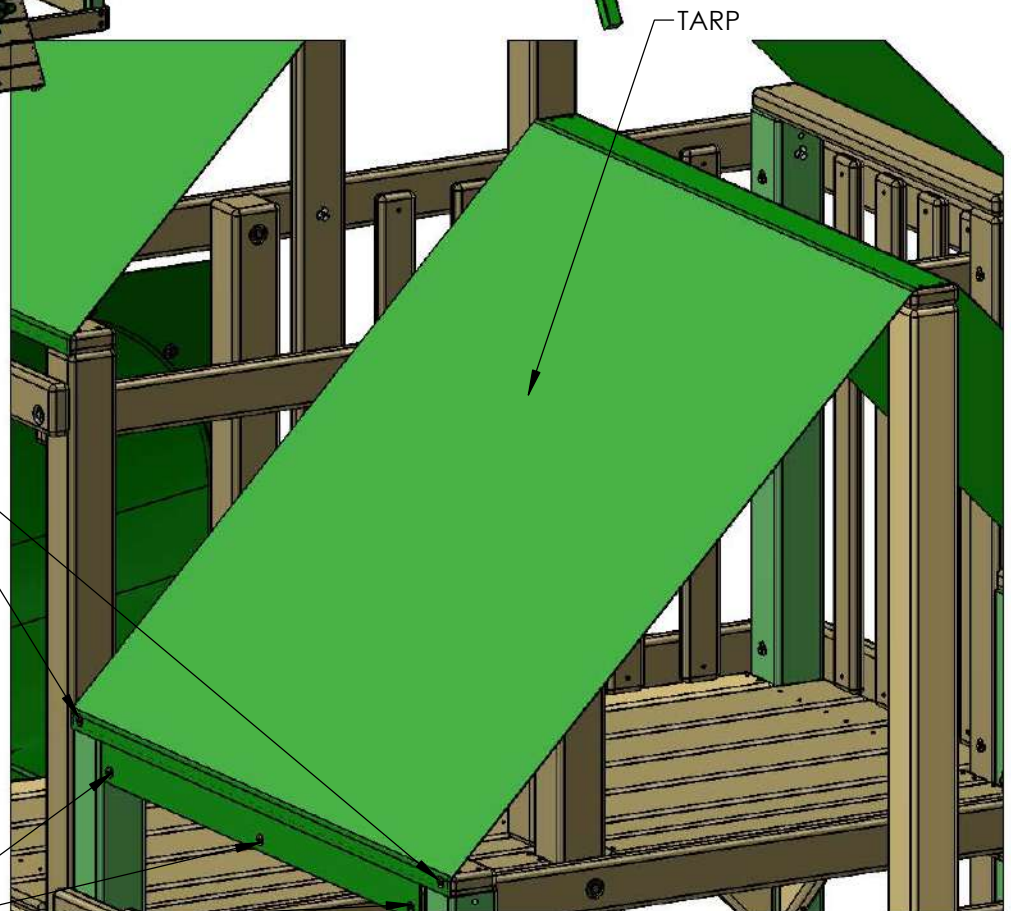

DETAIL A

STEP 56: SAFETY BOARDS

1: MEASURE 24" FROM THE BOTTOM OF THE CORNER POSTS ON THE RIGHT SIDE OF THE FORT. MARK THESE POSITIONS ON THE OUTSIDE OF THE CORNER POSTS. ATTACH THE 2 X 4 X 47-1/2" SAFETY BOARD WITH OFFSET HOLES ON THE CORNER POSTS WITH 5/16 X 3-1/2" LAG SCREWS AND 5/16 WASHERS.

2: PLACE THE 2 X 4 X 34" SAFETY BOARD (UPPER LEVEL) ON TOP OF THE 2 X 4 X 47-1/2" SAFETY BOARD (LOWER LEVEL). ATTACH IT WITH 5/16" X 3-1/2" LAG SCREWS AND 5/16" WASHERS.

NOTE: THE OFFSET HOLES CAN BE PLACED UP OR DOWN IN THIS STEP.

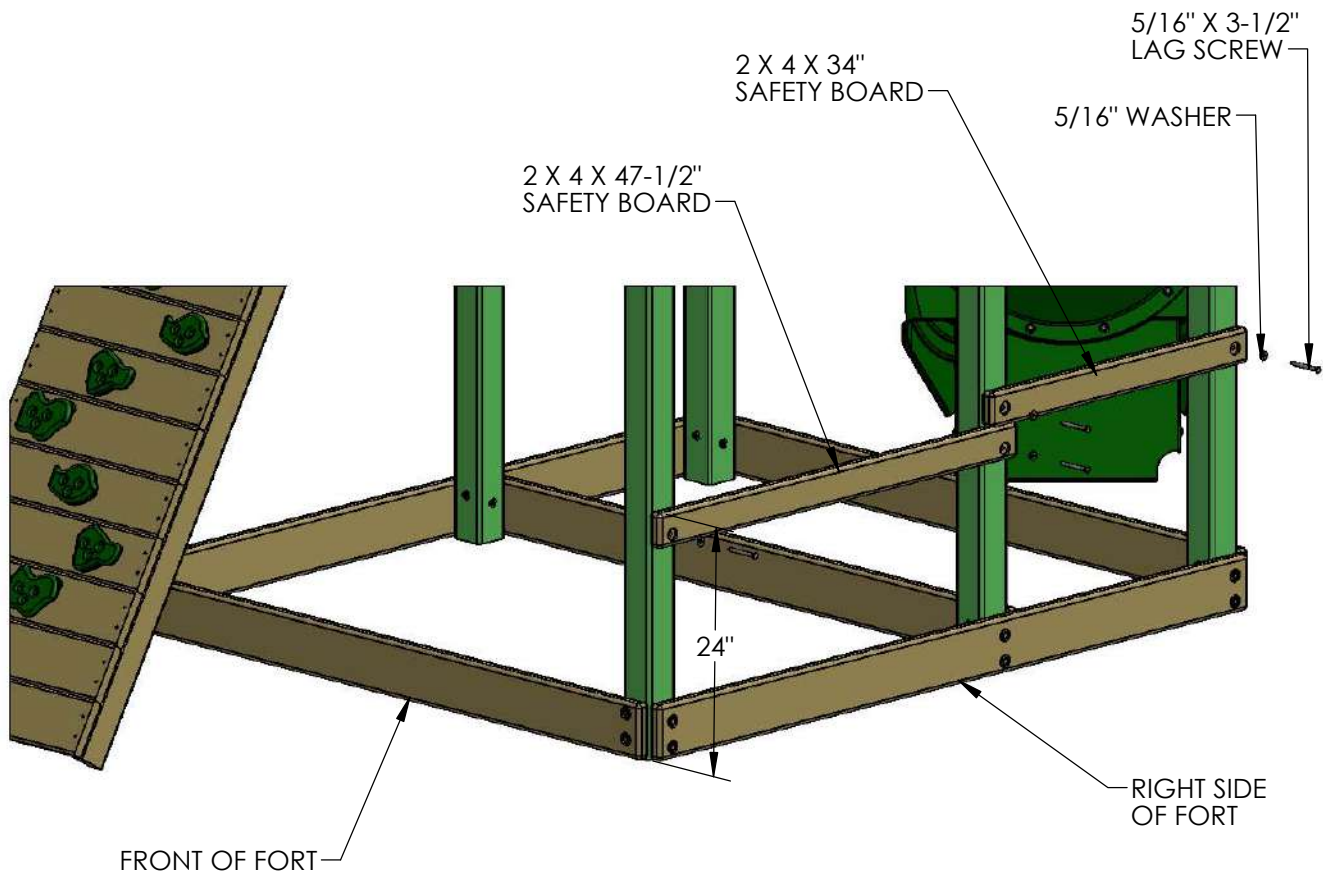

STEP 57: PICNIC TABLE

1: LOCATE TWO 2 X 4 X 14-3/4" PT TOP SUPPORTS, TWO 2 X 4 X 27-1/2" PT SEAT SUPPORTS, TWO 2 X 4 X 32-1/2" PT LEGS AND TWO 5/4 X 3 X 13-1/4" PICNIC TABLE SLATS.

2: FOR THE LEFT SIDE ASSEMBLY, PLACE A 2 X 4 X 14-3/4" PT TOP SUPPORT AND A 2 X 4 X 27-1/2" PT SEAT SUPPORT PARALLEL TO ONE ANOTHER. PLACE A 2 X 4 X 32-1/2" PT LEG ON TOP AT THE 7-1/2" DIMENSION. THE TOP OF THE PT LEG SHOULD BE FLUSH TO THE TOP OF THE PT TOP SUPPORT. ATTACH THE PT LEG TO THE SUPPORTS WITH #8 X 2-1/2" WOOD SCREWS.

3: FOR THE RIGHT SIDE ASSEMBLY, PLACE A 2 X 4 X 14-3/4" PT TOP SUPPORT AND A 2 X 4 X 27-1/2" PT SEAT SUPPORT PARALLEL TO ONE ANOTHER. PLACE A 2 X 4 X 32-1/2" PT LEG ON TOP AT THE 7-1/2" DIMENSION. THE TOP OF THE PT LEG SHOULD BE FLUSH TO THE TOP OF THE PT TOP SUPPORT. ATTACH THE PT LEG TO THE SUPPORTS WITH #8 X 2-1/2" WOOD SCREWS.

4: PLACE THE PICNIC TABLE SLAT NEXT TO THE PICNIC TABLE LEG FOR EACH ASSEMBLY BELOW. LEAVE A 3/16" GAP BETWEEN THE TOP OF THE SLAT AND THE LEG. USE THE 6-15/16" DIMENSION TO LOCATE THE BOTTOM END OF THE SLAT. FASTEN THE PICNIC TABLE SLAT TO THE SUPPORTS WITH TWO #8 X 2" WOOD SCREWS.

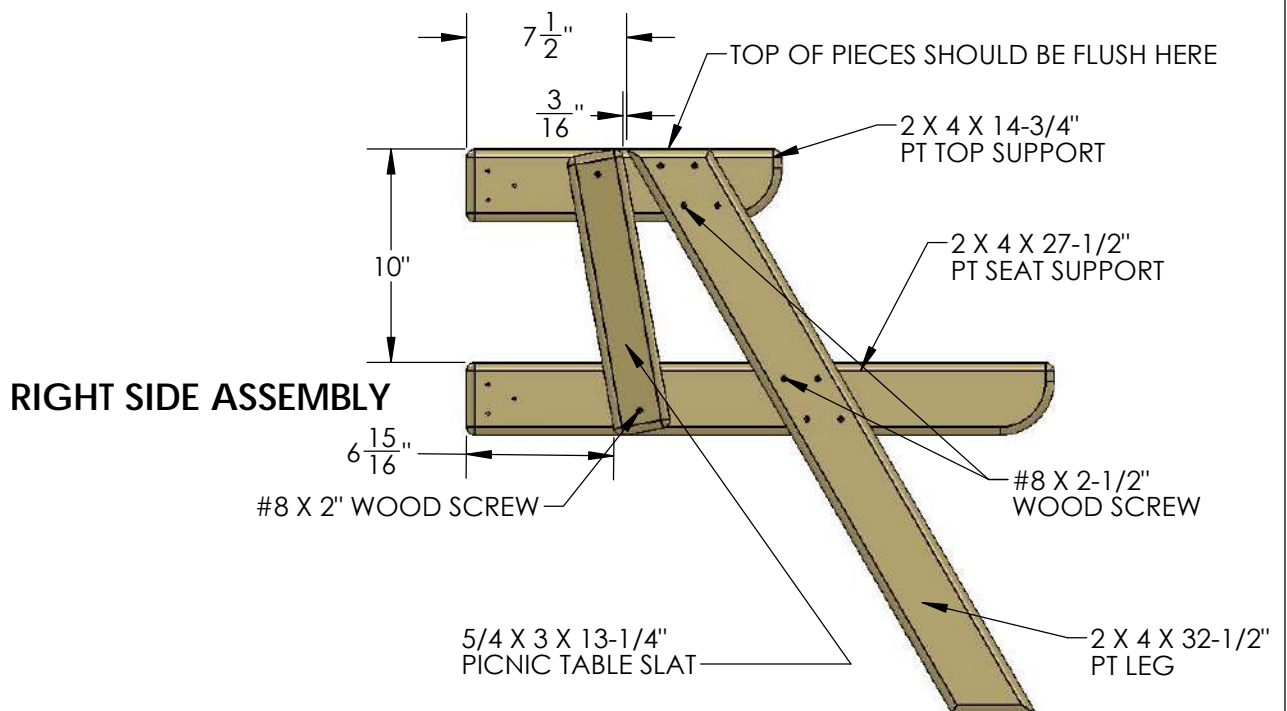
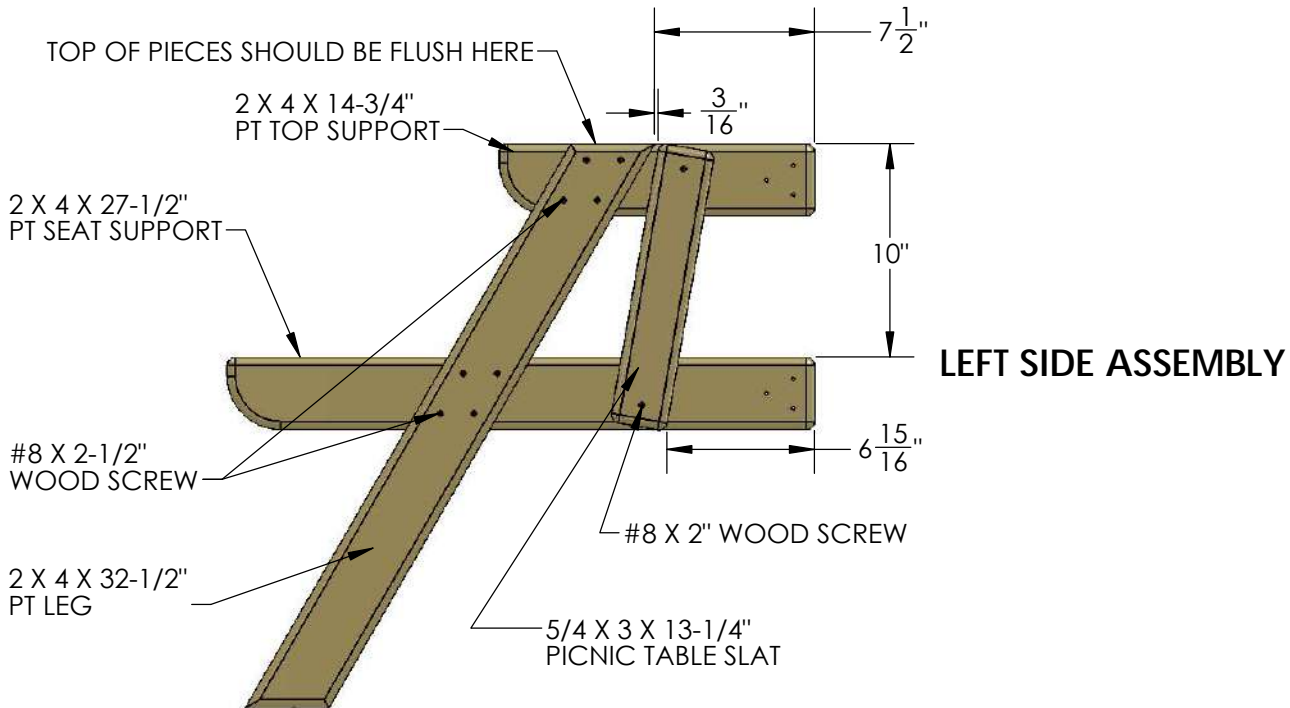

STEP 58: PICNIC TABLE

- 1: MEASURE UP $26\frac{3}{8}$ " FROM THE BOTTOM OF THE CORNER POSTS ON THE LEFT SIDE OF THE PLAYSET. MAKE MARKS ON THE INSIDE OF THE CORNER POSTS WITH A PEN OR PENCIL AT $26\frac{3}{8}$ ".
- 2: PLACE THE TOP OF THE RIGHT SIDE ASSEMBLY FLUSH TO THE MARK ON THE LEFT-MIDDLE CORNER POST. ATTACH THE RIGHT SIDE ASSEMBLY TO THE INSIDE OF THE CORNER POST WITH #8 X 3" WOOD SCREWS.
- 3: PLACE THE TOP OF THE LEFT SIDE ASSEMBLY FLUSH TO THE MARK ON THE LEFT-FRONT CORNER POST. ATTACH THE LEFT SIDE ASSEMBLY TO THE INSIDE OF THE CORNER POST WITH #8 X 3" WOOD SCREWS.

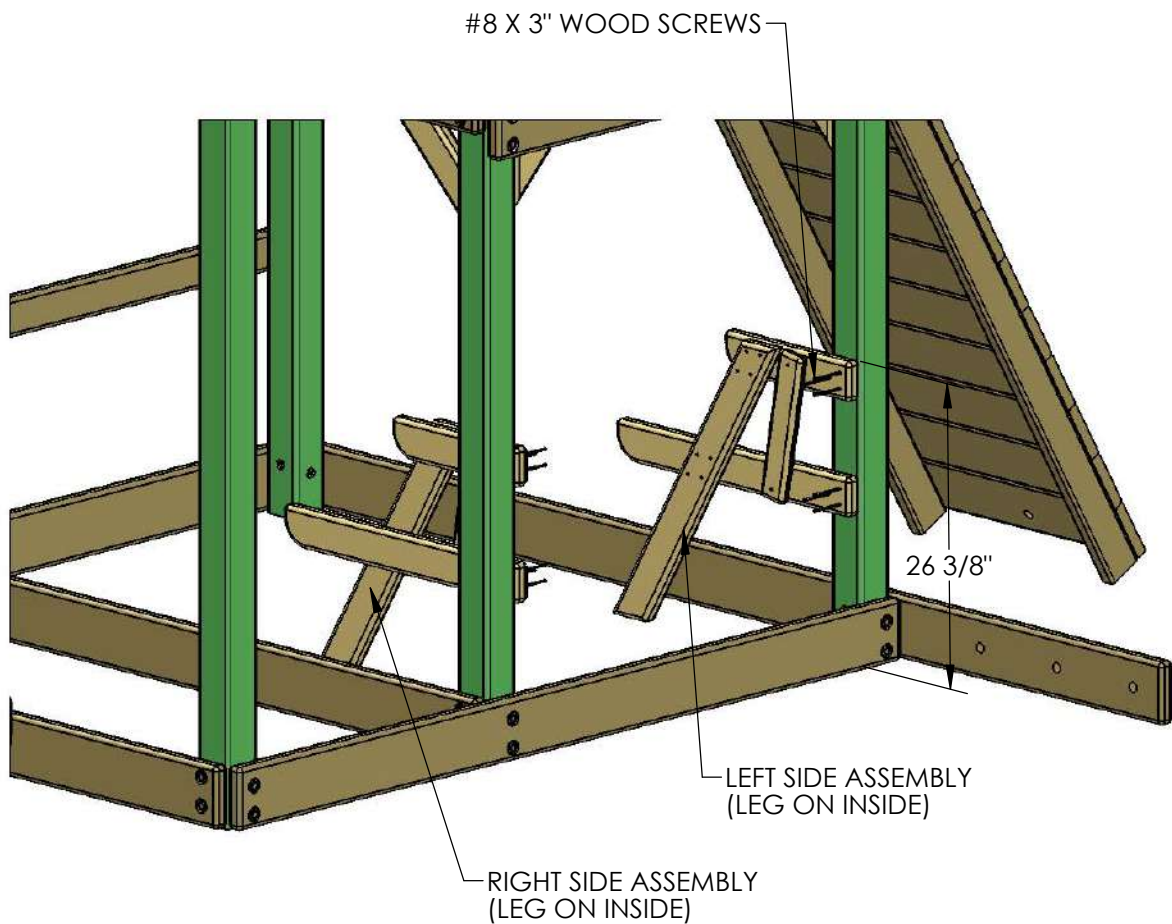

STEP 59: PICNIC TABLE

- 1: LOCATE FOUR 5/4 X 6 X 43" PT TOP AND SEAT BOARDS.
- 2: CENTER THE HOLES IN THE BOARDS OVER THE TOP OR SEAT SUPPORTS.
- 3: FASTEN THE PT TOP AND SEAT BOARDS TO THE TOP OR SEAT SUPPORTS WITH #8 X 2-1/2" WOOD SCREWS.

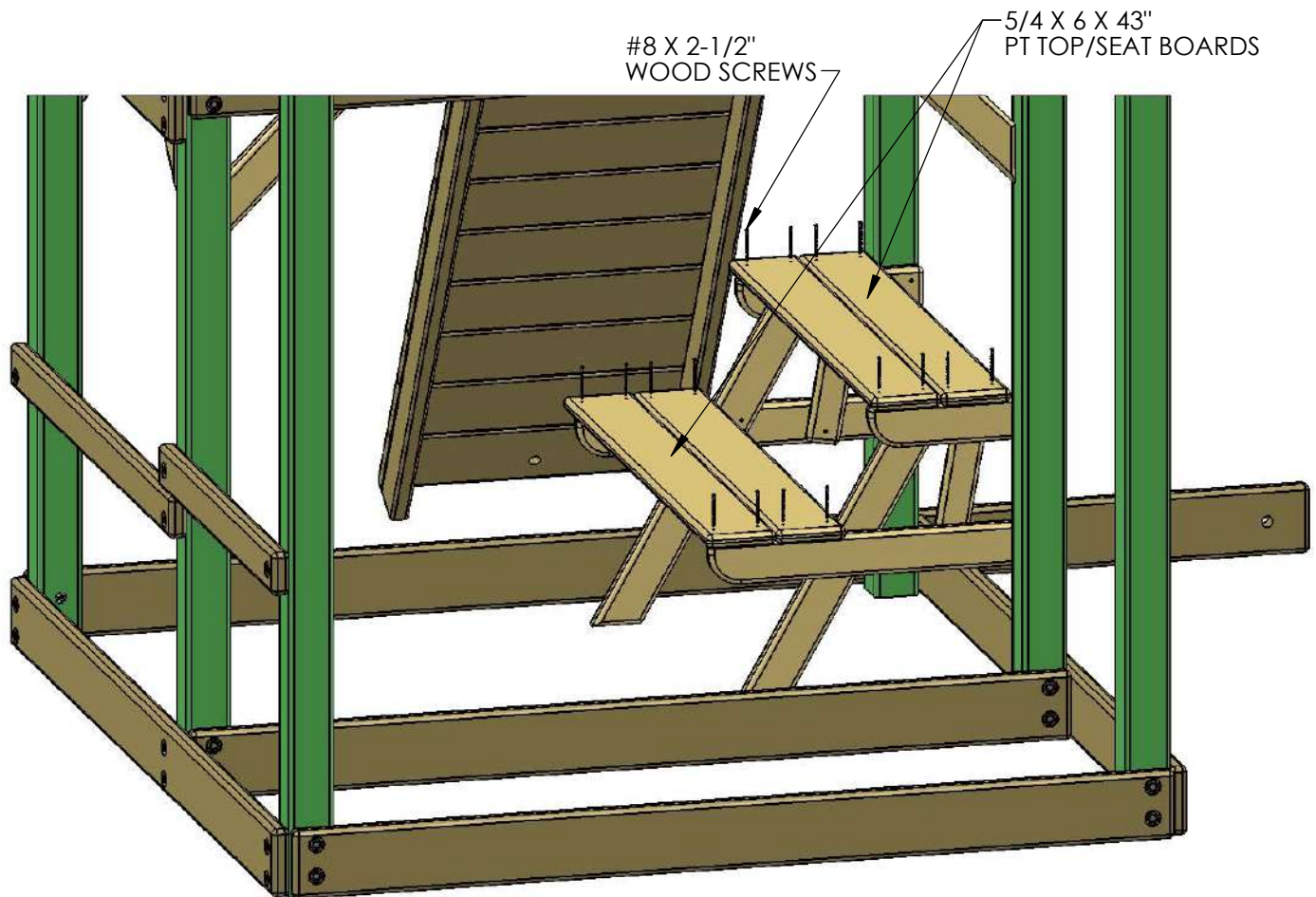

STEP 60: SANDBOX SEATS AND NAME PLATE

1: PLACE THE 5/4 X 6 X 22" SANDBOX SEATS ONTO THE TOP OF THE SANDBOX BOARDS AS SHOWN BELOW.

2: ATTACH THE SANDBOX SEATS TO THE SANDBOX BOARDS WITH #8 X 2" WOOD SCREWS.

3: LOCATE THE NAME PLATE FOR YOUR PLAY SET. ATTACH THE NAME PLATE TO THE FRONT OF THE SWING BEAM WITH #8 X 1" WOOD SCREWS.

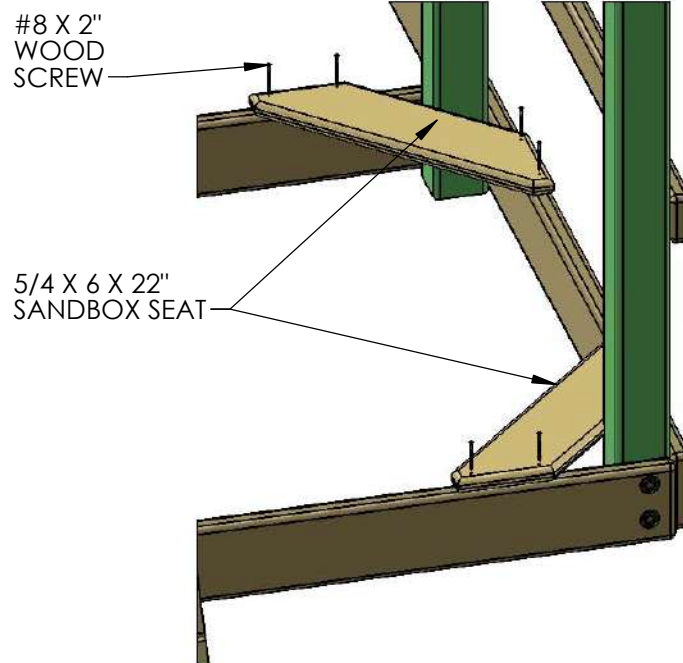
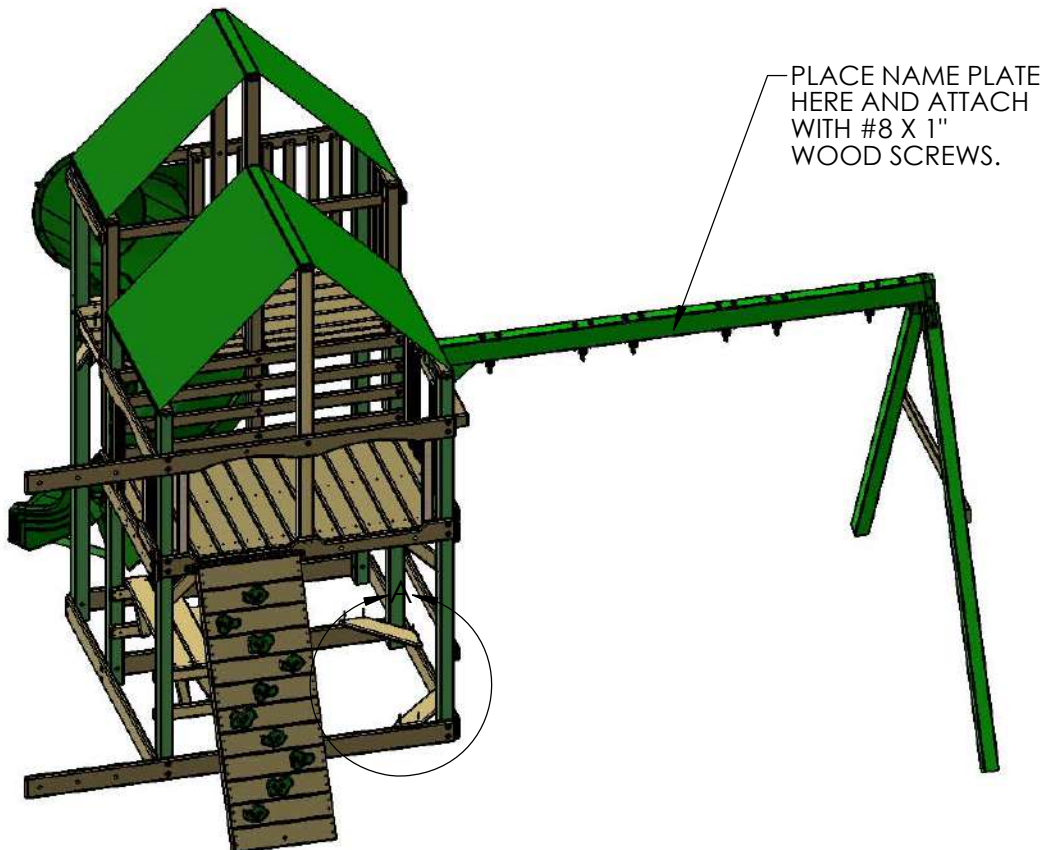

STEP 61: TIC TAC TOE ASSEMBLY

1: LOCATE THE TIC TAC TOE BOX.

2: FOLLOW THE INSTRUCTIONS IN THE BOX TO ASSEMBLE THE TIC TAC TOE OMITTING STEPS 6 AND 7.

3: LOCATE TWO 5/4 X 3 X 17-1/2" TIC TAC TOE MOUNTS.

4: USE THE SCREWS INCLUDED WITH THE TIC TAC TOE TO ATTACH THE GREEN BRACKETS TO THE TIC TAC TOE MOUNTS. EACH GREEN BRACKET SHOULD BE CENTERED OVER THE TIC TAC TOE MOUNT.

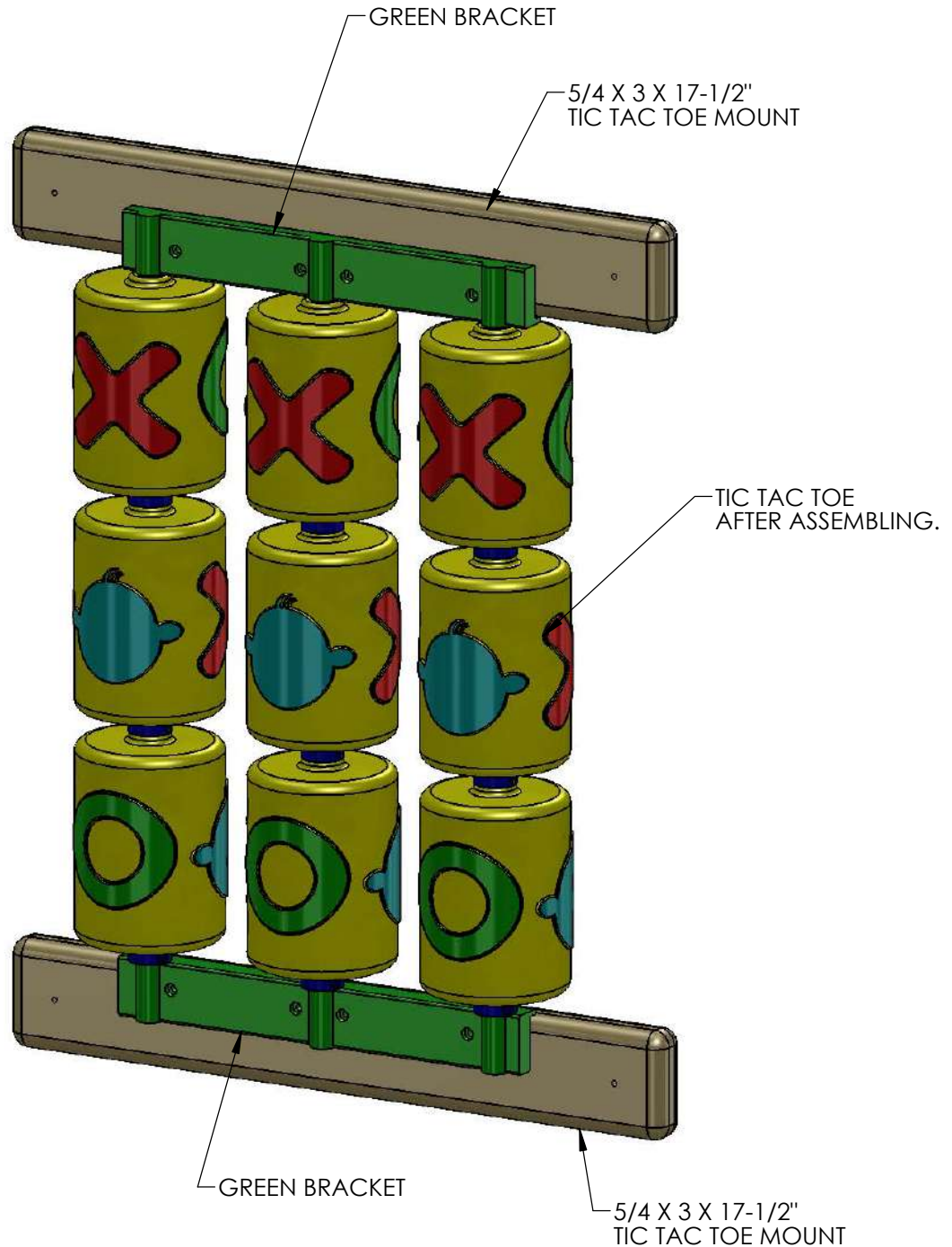

STEP 62: TIC TAC TOE INSTALLATION

1: PLACE THE TIC TAC TOE AGAINST THE PANEL SLATS AT THE RIGHT SIDE OF THE PLAYSET ON THE INSIDE. THE TIC TAC TOE MOUNT SHOULD BE APPROXIMATELY 4" OFF THE DECK.

2: ATTACH THE TIC TAC TOE MOUNTS TO THE PANEL SLATS WITH #8 X 1-3/4" WOOD SCREWS.

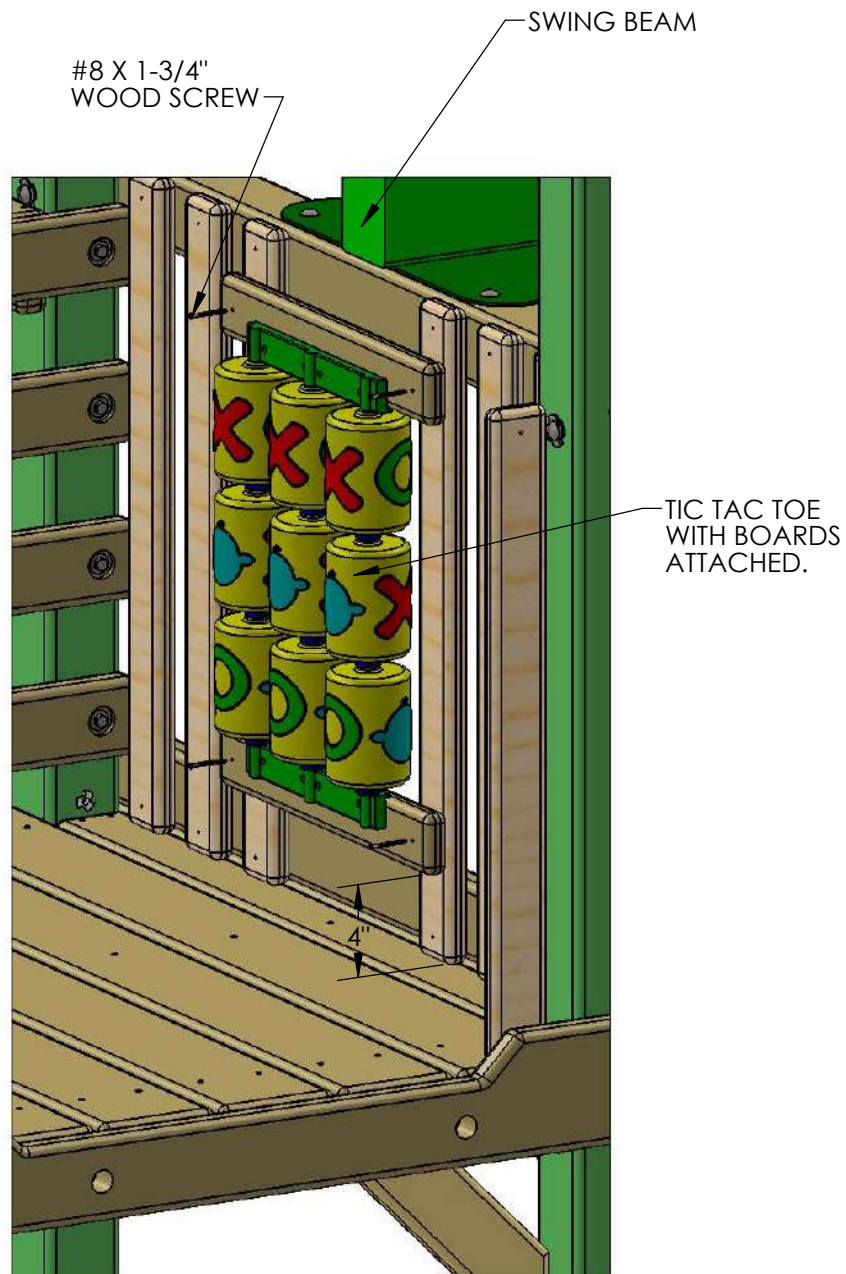

STEP 63: ROPE LADDER

1: FIND THREE ROPE LADDER ROPES. MAKE A KNOT IN THE END OF EACH ROPE AND THREAD THE FREE END THROUGH THE BACK SIDE OF THE ROPE LADDER SUPPORT. PULL EACH ROPE TAUGHT.

2: MEASURE DOWN FROM THE BOTTOM OF THE ROPE LADDER SUPPORT 6 INCHES AND TIE A KNOT. THE BOTTOM OF THE KNOT SHOULD BE 6 INCHES BELOW THE ROPE LADDER SUPPORT. SLIDE EACH ROPE THROUGH THE HOLES IN ONE ROPE LADDER RUNG. SLIDE THE RUNG UP AGAINST THE BOTTOM OF THE KNOTS.

3: TIE THREE KNOTS BELOW THE ROPE LADDER RUNG.

4: MEASURE DOWN FROM THE BOTTOM OF THE ROPE LADDER RUNG 10-5/8 INCHES AND MAKE A MARK ON THE ROPE WITH A PIECE OF TAPE OR A MARKER. THREAD ANOTHER ROPE LADDER RUNG ONTO THE ROPES.

5: WITH THE TOP OF THE RUNG EVEN WITH THE 10-5/8 INCH MARK TIE THREE KNOTS BELOW THE SECOND ROPE LADDER RUNG.

6: REPEAT SUBSTEPS 4-5 FOR THE REMAINING ROPE LADDER RUNGS.

7: THREAD THE BOTTOM END OF EACH ROPE THROUGH THE HOLES IN THE ROPE LADDER RUNNER AND TIE THEM OFF. GRAB EACH ROPE AND ATTEMPT TO WRAP IT AROUND YOUR HAND. IF THE ROPE WRAPS AROUND YOUR HAND IT IS TOO LOOSE. IF THE ROPE IS TOO LOOSE UNTIE THE KNOT BEHIND THE ROPE LADDER RUNNER AND RETIE IT UNTIL YOU CAN NO LONGER WRAP THE ROPE AROUND YOUR HAND.

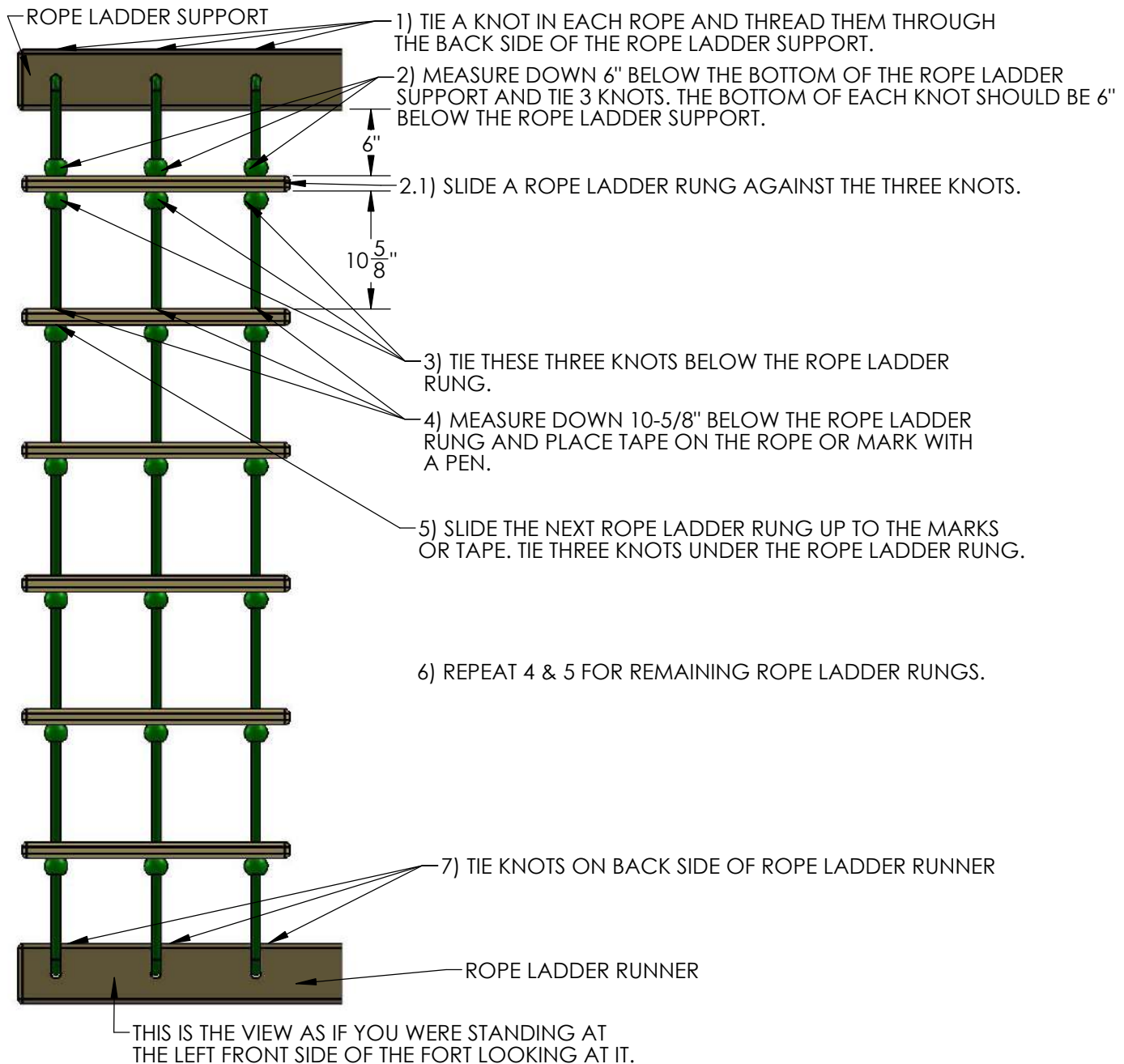

STEP 64: ROCK WALL ROPE

1: TIE A KNOT AT ONE END OF THE 10' ROPE AND THREAD IT THROUGH THE BACK SIDE OF THE HOLE IN THE ROPE LADDER SUPPORT.

2: THE UNTIED END WILL GO THROUGH THE HOLE OF THE BOTTOM ROCK WALL BOARD. TIE A SECURE KNOT AT THE END MAKING SURE THAT THE ROPE IS TIGHT AND WILL NOT WRAP AROUND YOUR HAND. HINT: TO REDUCE THE AMOUNT OF SLACK IN THE ROPE, LIFT THE ROCK WALL ASSEMBLY SLIGHTLY WHEN TYING THE KNOT IN THE BOTTOM ROCK WALL BOARD. WHEN YOU LOWER THE ASSEMBLY, THE KNOT WILL TIGHTEN.

TIE A KNOT AND THREAD
THE ROPE THROUGH THE
BACK SIDE OF THIS HOLE IN
THE ROPE LADDER SUPPORT

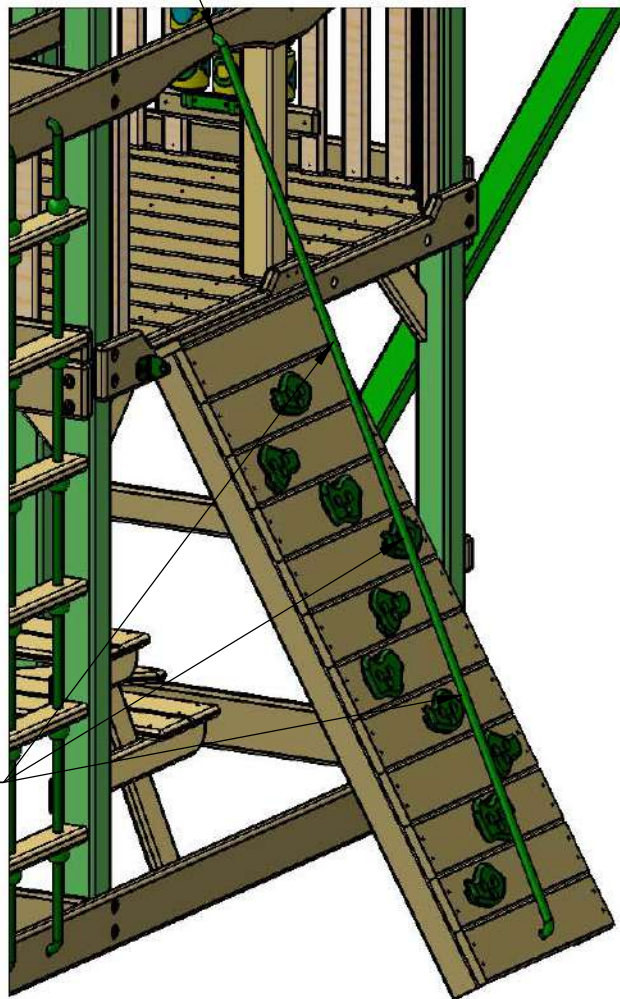

YOU MAY TIE UP TO THREE
KNOTS SPACED ABOUT 18"
APART TO AID IN CLIMBING.

STEP 65: SAFETY HANDLES (LOWER LEVEL)

- 1: LOCATE THE SAFETY HANDLE BAG.
- 2: ADJUST THE SAFETY HANDLES UP OR DOWN TO SUIT THE NEEDS OF YOUR CHILD.
- 3: ATTACH EACH SAFETY HANDLE TO THE PANEL SLATS WITH TWO PAN HEAD SCREWS AND TWO WASHERS PROVIDED WITH THE SAFETY HANDLES.

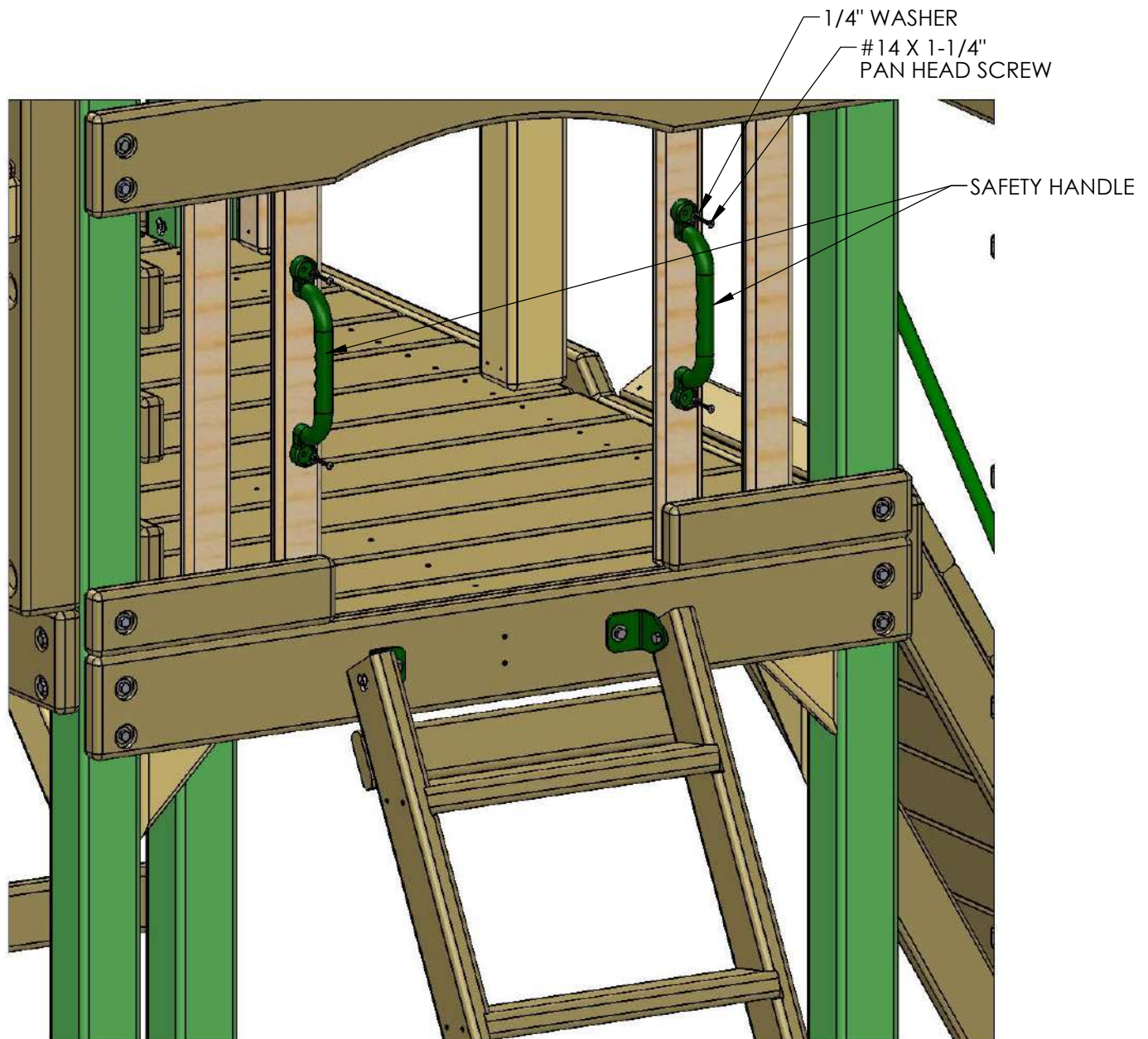

STEP 66: SAFETY HANDLES (UPPER LEVEL)

1: LOCATE THE SAFETY HANDLE BAG

2: ADJUST THE SAFETY HANDLES UP OR DOWN TO SUIT THE NEEDS OF YOUR CHILD.

3: ATTACH EACH SAFETY HANDLE TO THE LAG POSTS AND CENTER POST WITH TWO PAN HEAD SCREWS AND TWO WASHERS PROVIDED WITH THE SAFETY HANDLES.

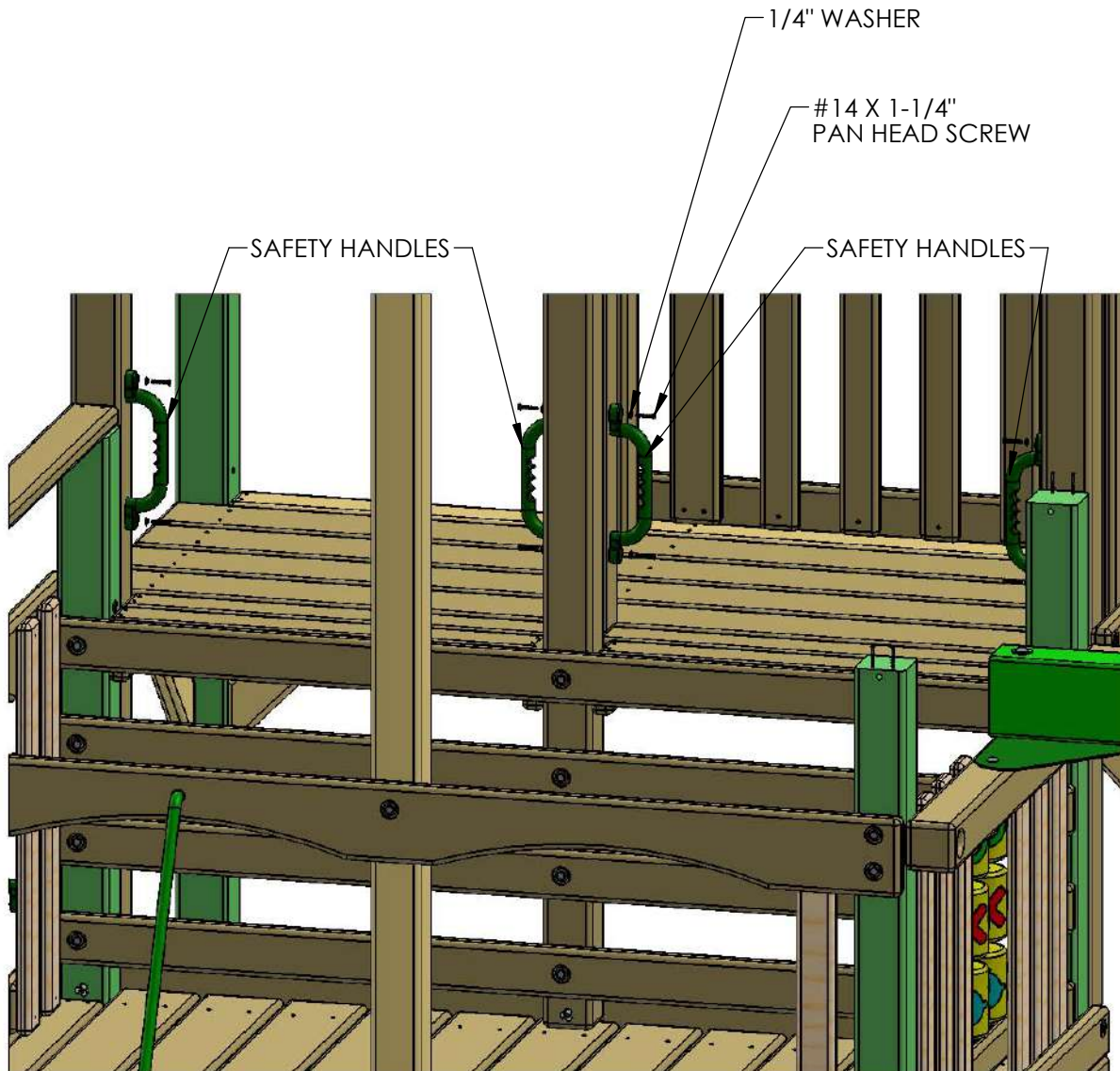

STEP 67: FLAG KIT

1: PLACE A FLAG ON THE CORNER POSTS AT THE FRONT OF THE FORT.

2: ATTACH THE BASE OF THE FLAG WITH 1/2" PHILLIPS HEAD SCREWS PROVIDED.
****DO NOT OVER-TIGHTEN****

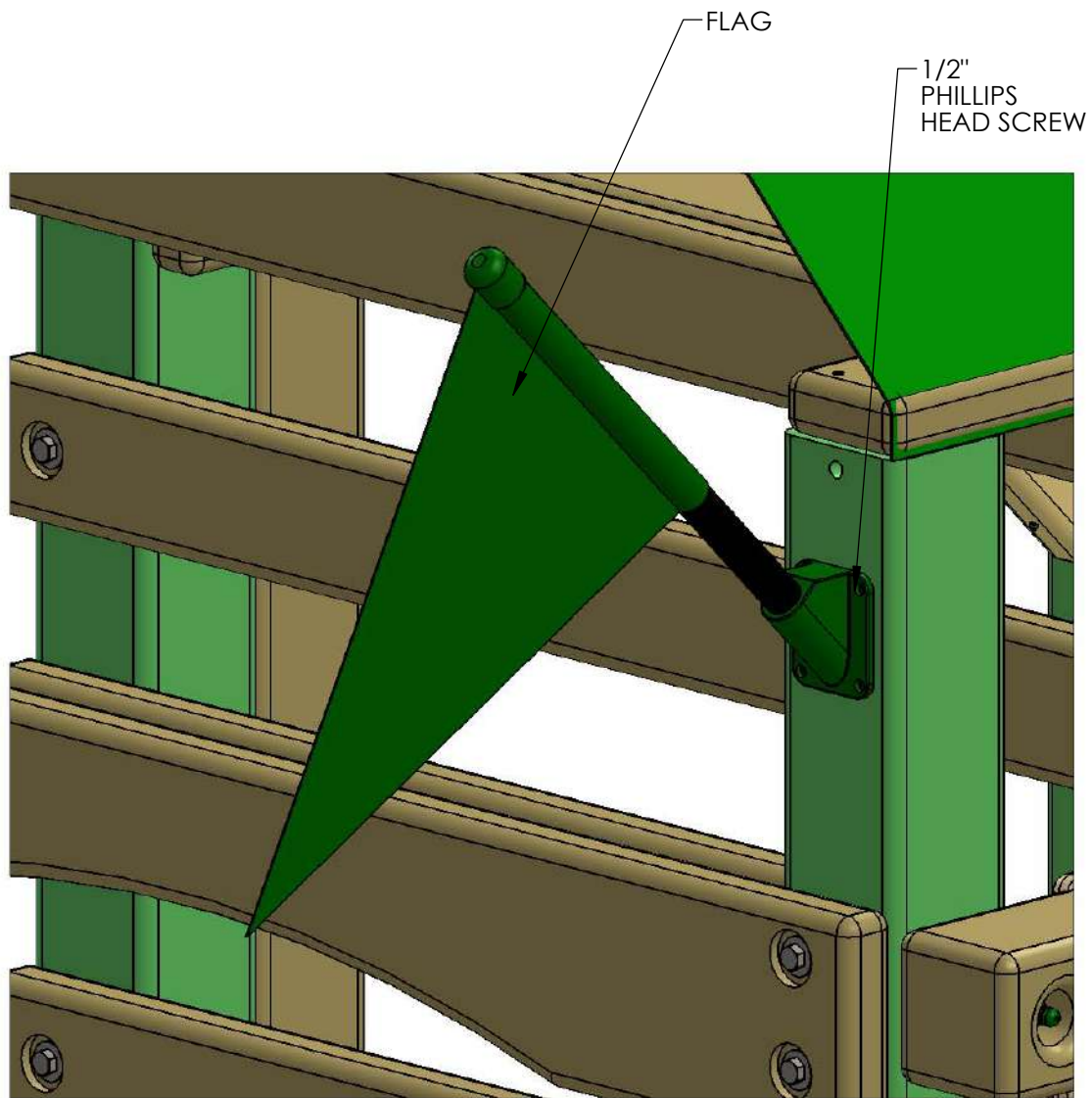

STEP 68: TELESCOPE

1: WITH THE 1-1/4" WOOD SCREWS PROVIDED IN THE TELESCOPE BAG, FASTEN ONE OF THE SQUARE TELESCOPE BRACKETS TO THE ROPE LADDER SUPPORT ON THE ROCK WALL SIDE OF THE CENTER POST.

2: PLACE THE TELESCOPE STAND AND TELESCOPE INTO THE SLOT OF THE TELESCOPE BRACKET.

3: FASTEN THE REMAINING TELESCOPE BRACKET TO THE OPPOSITE SIDE THAT THE FIRST TELESCOPE BRACKET WAS INSTALLED ON WITH 1-1/4" WOOD SCREWS PROVIDED WITH THE TELESCOPE.

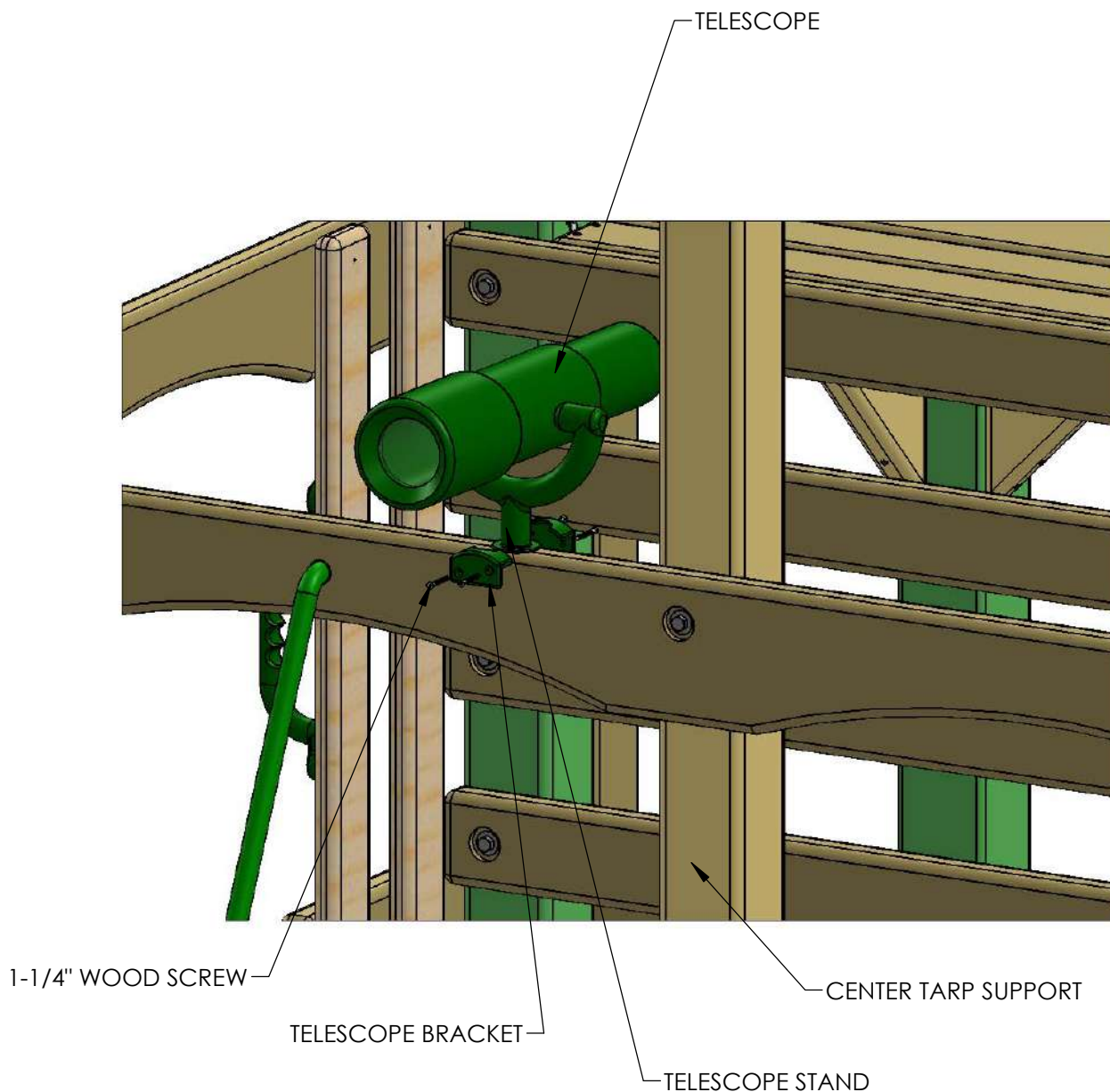

STEP 69: STEERING WHEEL

- 1: GO TO THE REAR CENTER POST ON THE DECK (UPPER LEVEL).
- 2: DRILL A 3/16" PILOT HOLE 1" BELOW THE CENTER OF THE T-NUT. DRILL THE HOLE 2" DEEP.
- 3: PLACE THE STEERING WHEEL INSERT INSIDE THE STEERING WHEEL.
- 4: USE THE 2-1/2" LAG SCREW AND WASHER TO FASTEN THE STEERING WHEEL TO THE REAR CENTER POST. DO NOT OVER-TIGHTEN THE LAG SCREW OR THE STEERING WHEEL WILL NOT TURN.
- 5: PLACE THE STEERING WHEEL CAP OVER THE STEERING WHEEL AND SNAP IT INTO THE STEERING WHEEL INSERT.

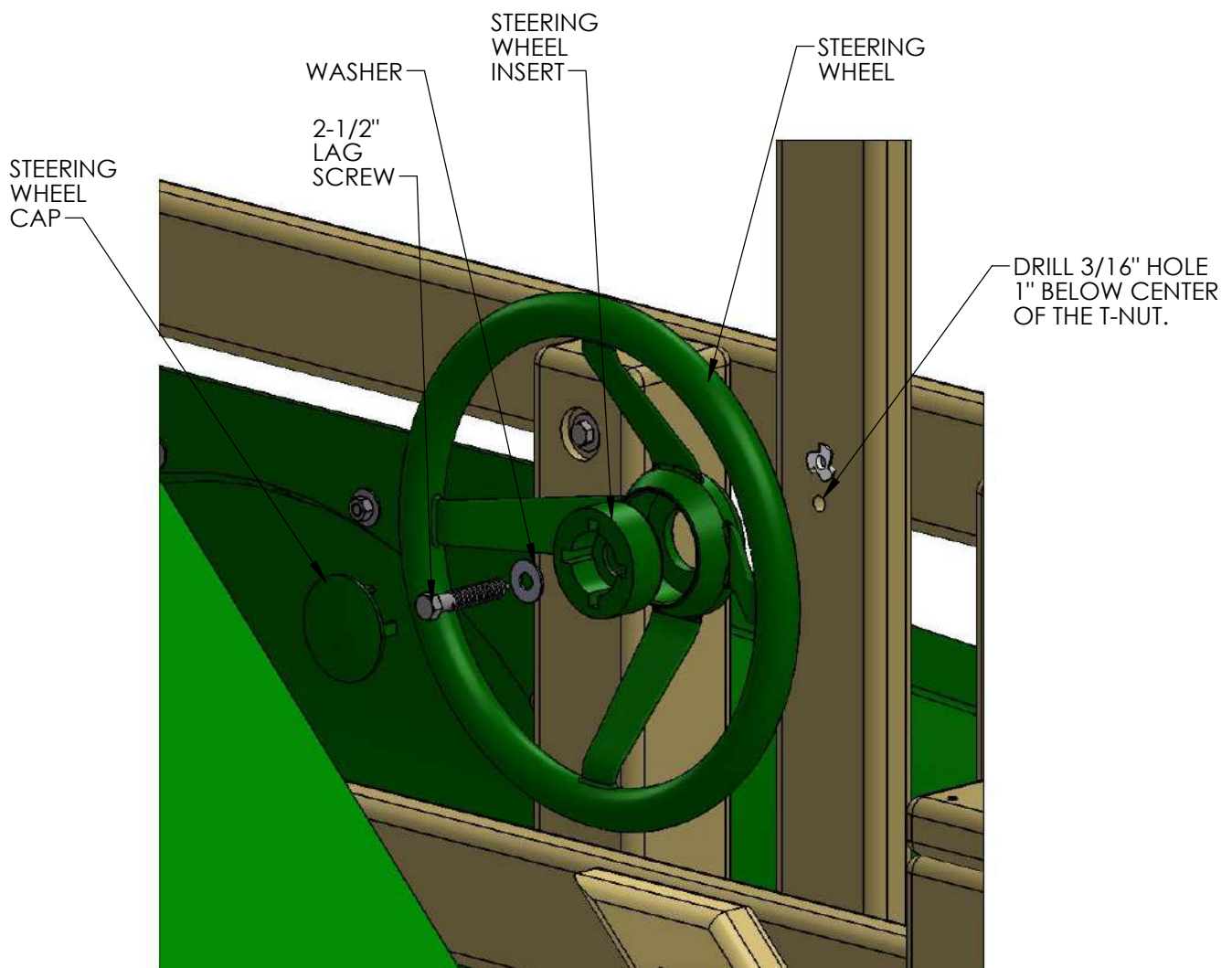

STEP 70: HANGING THE SWINGS

- 1: START BY ATTACHING ONE SPRING CLIP TO EACH IRON DUCTILE ON THE SWING BEAM.
- 2: ATTACH ONE CHAIN PER ACCESSORY TO EACH SPRING CLIP.
- 3: ADJUST HEIGHT AS NEEDED.

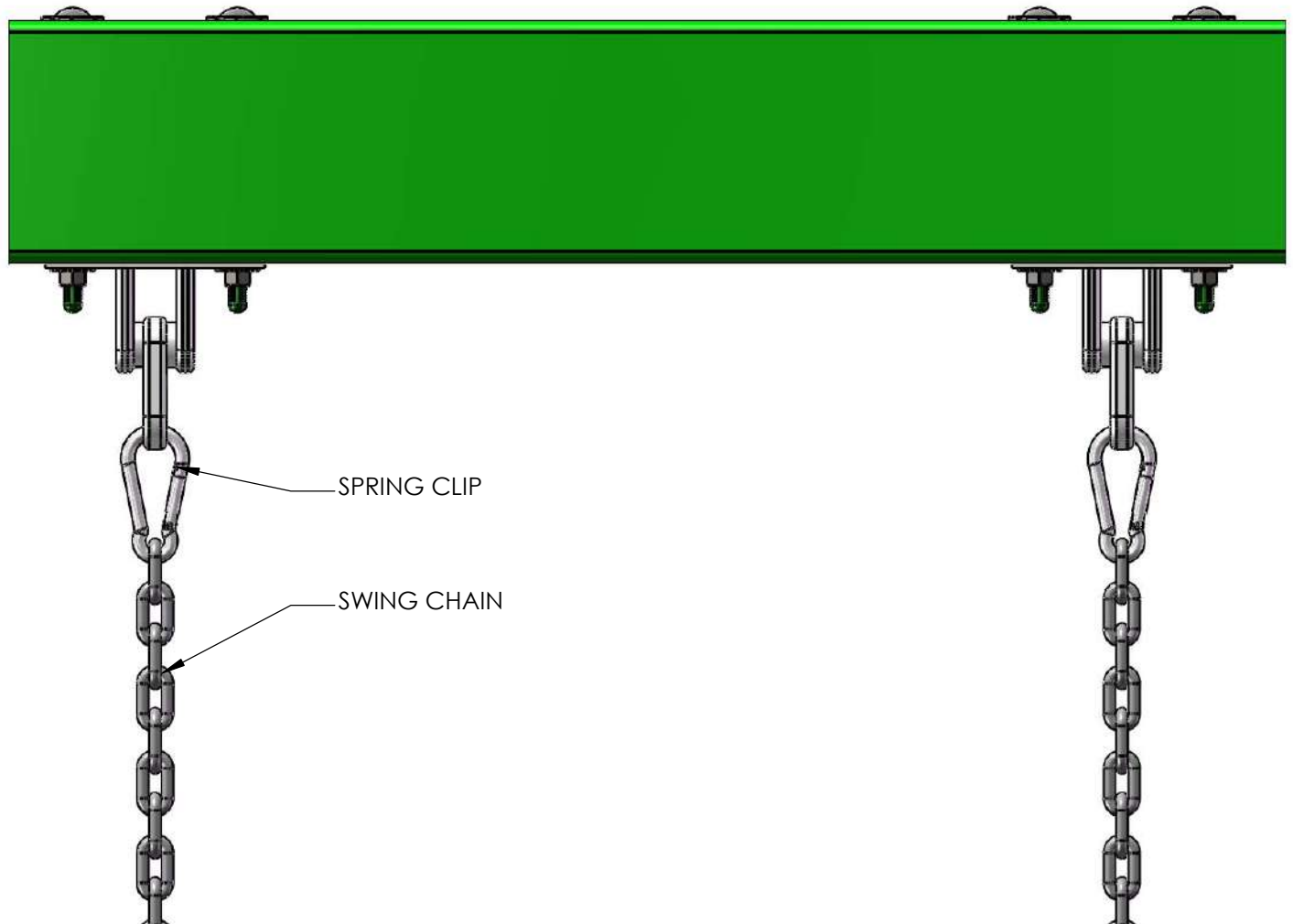

STEP 71: GROUND STAKES

1: HAMMER A GROUND STAKE INTO THE EARTH NEXT TO EACH SWING LEG AT AN ANGLE. DO NOT HOLD THE UPPER PORTION OF THE STAKE AFTER THE FIRST COUPLE OF HITS OR IT MAY VIBRATE HARSHLY AGAINST YOUR HAND. IF THE TOP PART OF THE STAKE TWISTS WHEN IT ENCOUNTERS A ROCK OR ROOT YOU MAY HAVE TO BEND THE TOP PORTION OF THE STAKE AGAINST THE SWING LEG. FINALLY INSTALL THE SCREW AND WASHER.

2: ATTACH EACH GROUND STAKE TO THE SWING LEG WITH A #14 X 2" PAN HEAD SCREW AND A 1/4" FENDER WASHER PROVIDED WITH THE GROUND STAKE.

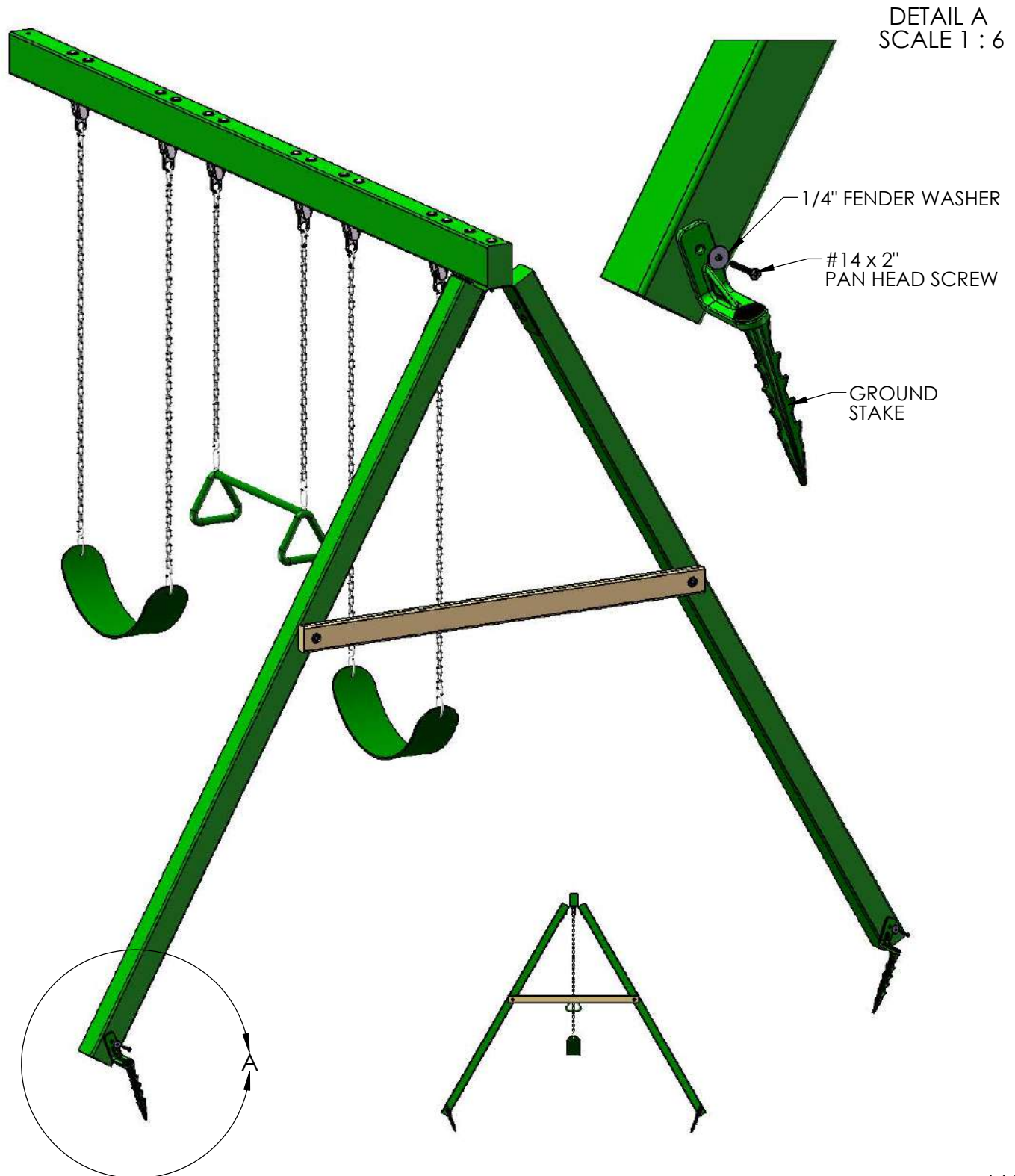

STEP 72: ATTACHING SUPER SCOOP SLIDE

1: PLACE THE SUPER SCOOP SLIDE IN THE OPENING AT THE LEFT SIDE OF THE UPPER LEVEL OF THE FORT. LAY THE SLIDE ON THE DECK WITH THE LIP EXTENDING ONTO THE DECK.

2: ATTACH THE SLIDE TO THE DECK WITH #14 X 3" PAN HEAD SCREWS. ****DO NOT OVER TIGHTEN****

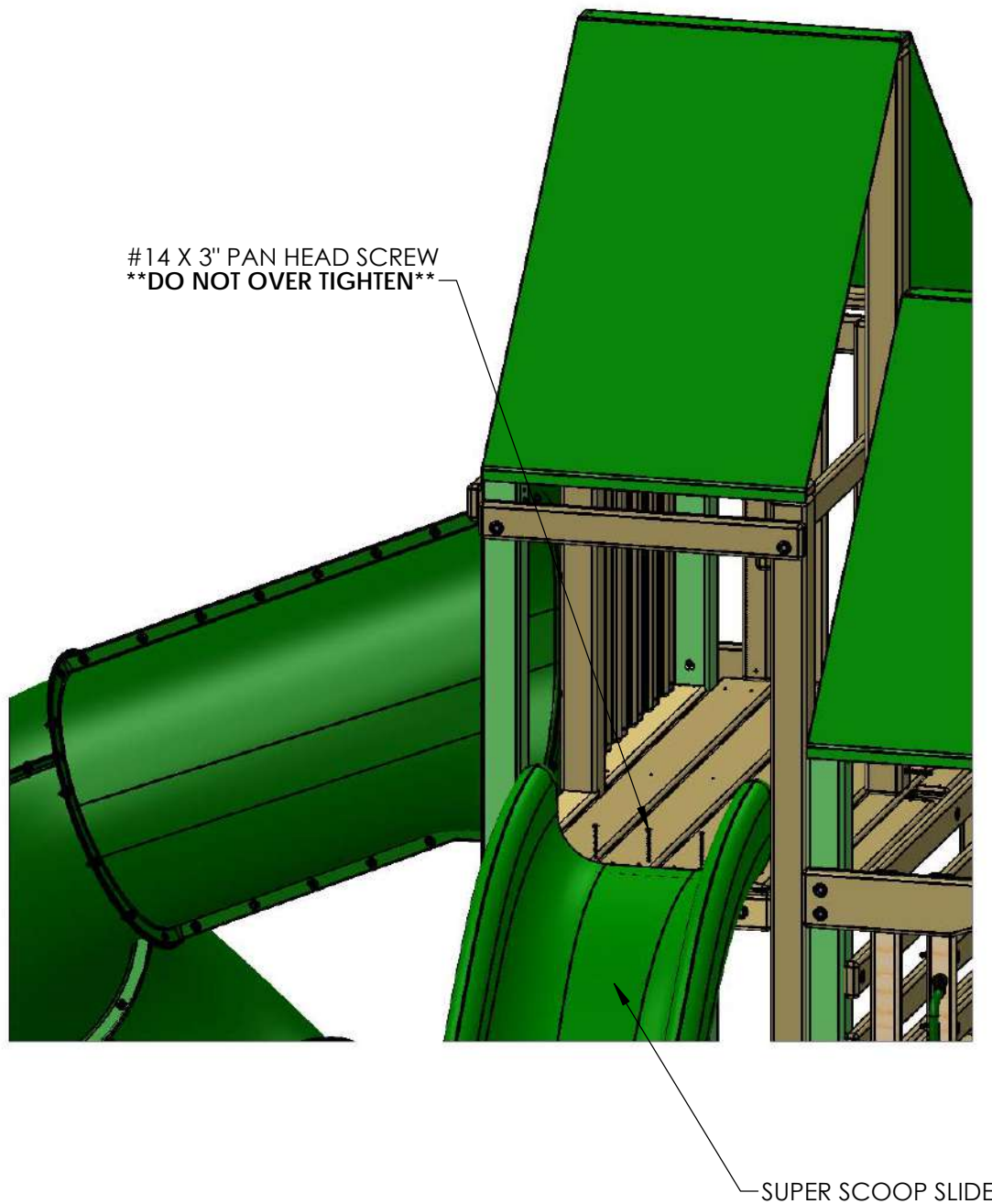

PART 2

CLATTER BRIDGE ASSEMBLY

STEP 1: ATTACHING T-NUTS TO THE CORNER POSTS

1: THIS STEP IS CRITICAL TO BUILDING THE FORT PROPERLY. IF ANY MISTAKES ARE MADE HERE, YOU WILL NEED TO DIS-ASSEMBLE AND THEN RE-ASSEMBLE TO MAKE YOUR CORRECTIONS.

2: MAKE SURE HOLES ARE FREE OF ANY OBSTRUCTIONS. USE A BOLT TO CLEAN OUT ANY DEBRIS.

3: LAY OUT EACH OF THE 4 X 4 X 96" CORNER POSTS IN THE AREA YOU INTEND ON BUILDING THE TOWER OF THE CLATTER BRIDGE.

4: USE THE DIAGRAM BELOW TO CORRECTLY IDENTIFY AND ORIENT THE NECESSARY DIRECTION THE POSTS SHOULD FACE. NOTE LETTERS A, B, C AND D ARE FOR REFERENCE ONLY. YOUR POSTS ARE **NOT** LABELED WITH THESE LETTERS.

5: USE A HAMMER TO SEAT THE T-NUTS AFTER INSERTING THEM INTO THE HOLES SHOWN IN THE DIAGRAM BELOW.

6: THE BARREL OF THE T-NUT SHOULD GO IN THE HOLE FIRST. HAMMER THE T-NUT UNTIL IT IS FLUSH/ALMOST FLUSH TO THE CORNER POSTS.

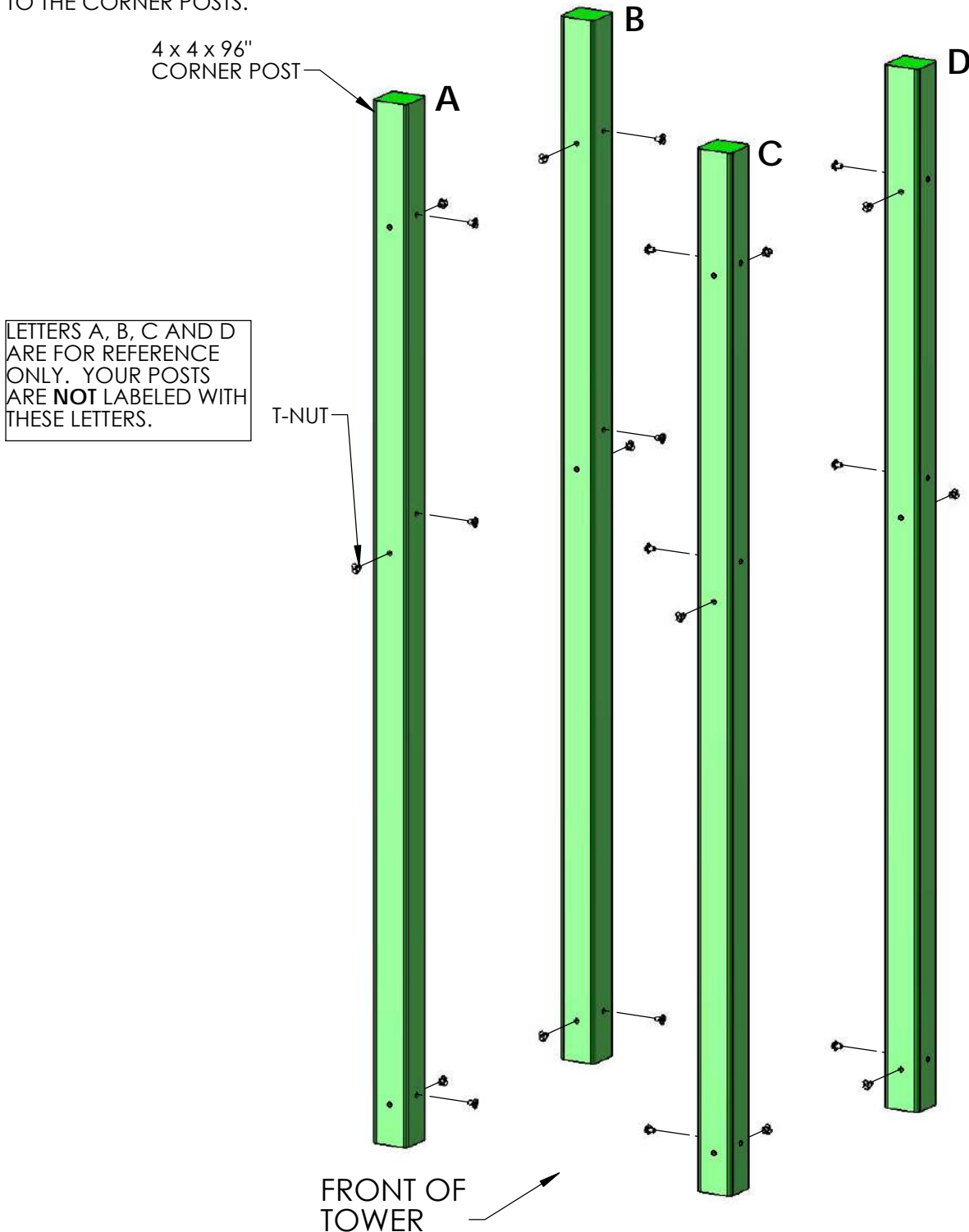

STEP 2: ASSEMBLING THE RIGHT SIDE FRAME

1: LAY THE 2 X 6 X 36-3/4" SANDBOX BOARD ON TOP OF THE RIGHT SIDE CORNER POSTS AT THE BOTTOM OF THE CORNER POSTS. THE COUNTERSUNK HOLES IN THE SANDBOX BOARD MUST BE OFFSET UP.

2: USE 5/16 X 4-1/2" HEX BOLTS AND 5/16" WASHERS TO ATTACH THE TOP HOLES OF THE SANDBOX BOARD TO THE T-NUTS INSTALLED ON THE CORNER POSTS. THE BOTTOM HOLES WILL BE USED LATER.

3: LAY THE 2 X 6 X 36-3/4" BOTTOM PANEL BOARD ON TOP OF THE RIGHT SIDE CORNER POSTS IN THE MIDDLE OF THE CORNER POSTS. THE COUNTERSUNK HOLES IN THE BOTTOM PANEL BOARD MUST BE OFFSET UP.

4: USE 5/16 X 4-1/2" HEX BOLTS AND 5/16" WASHERS TO ATTACH THE TOP HOLES OF THE BOTTOM PANEL BOARD TO THE T-NUTS INSTALLED ON THE CORNER POSTS. THE BOTTOM HOLES WILL BE USED LATER.

5: LAY THE 2 X 4 X 36-3/4" TOP PANEL BOARD ON TOP OF THE RIGHT SIDE CORNER POSTS.

6: USE 5/16 X 4-1/2" HEX BOLTS AND 5/16" WASHERS TO ATTACH THE COUNTERSUNK HOLES OF THE TOP PANEL BOARD TO THE T-NUTS INSTALLED ON THE CORNER POSTS.

7: DO NOT INSTALL LAG SCREWS AT THIS TIME.

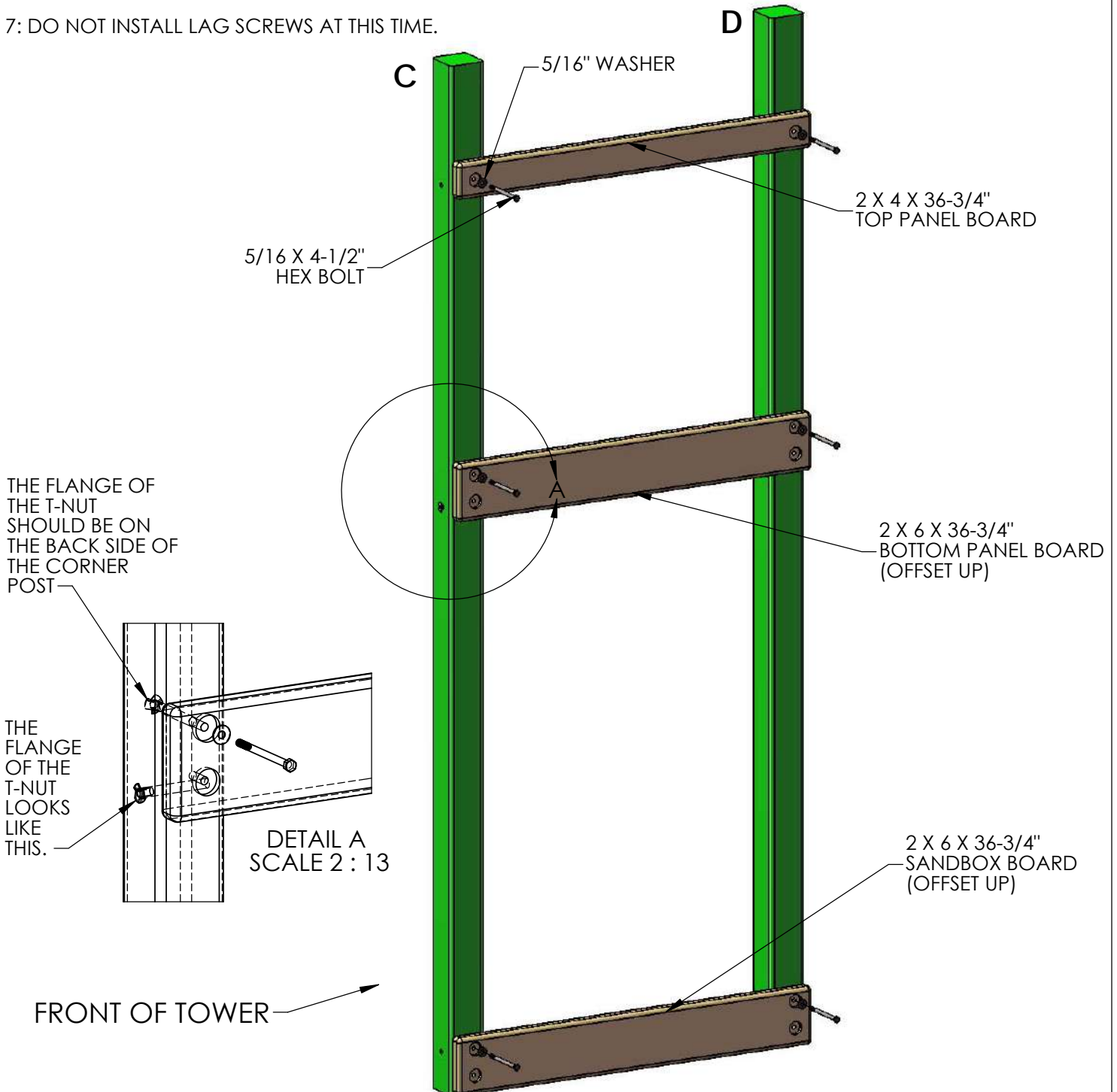

STEP 3: ASSEMBLING THE LEFT SIDE FRAME

1: LAY THE 2 X 6 X 36-3/4" SANDBOX BOARD ON TOP OF THE LEFT SIDE CORNER POSTS AT THE BOTTOM OF THE CORNER POSTS. THE COUNTERSUNK HOLES IN THE SANDBOX BOARD MUST BE OFFSET UP.

2: USE 5/16 X 4-1/2" HEX BOLTS AND 5/16" WASHERS TO ATTACH THE TOP HOLES OF THE SANDBOX BOARD TO THE T-NUTS INSTALLED ON THE CORNER POSTS. THE BOTTOM HOLES WILL BE USED LATER.

3: LAY THE 2 X 6 X 36-3/4" BOTTOM PANEL BOARD ON TOP OF THE LEFT SIDE CORNER POSTS IN THE MIDDLE OF THE CORNER POSTS. THE COUNTERSUNK HOLES IN THE BOTTOM PANEL BOARD MUST BE OFFSET UP.

4: USE 5/16 X 4-1/2" HEX BOLTS AND 5/16" WASHERS TO ATTACH THE TOP HOLES OF THE BOTTOM PANEL BOARD TO THE T-NUTS INSTALLED ON THE CORNER POSTS. THE BOTTOM HOLES WILL BE USED LATER.

5: LAY THE 2 X 4 X 36-3/4" TOP PANEL BOARD ON TOP OF THE LEFT SIDE CORNER POSTS.

6: USE 5/16 X 4-1/2" HEX BOLTS AND 5/16" WASHERS TO ATTACH THE COUNTERSUNK HOLES OF THE TOP PANEL BOARD TO THE T-NUTS INSTALLED ON THE CORNER POSTS.

7: DO NOT INSTALL LAG SCREWS AT THIS TIME.

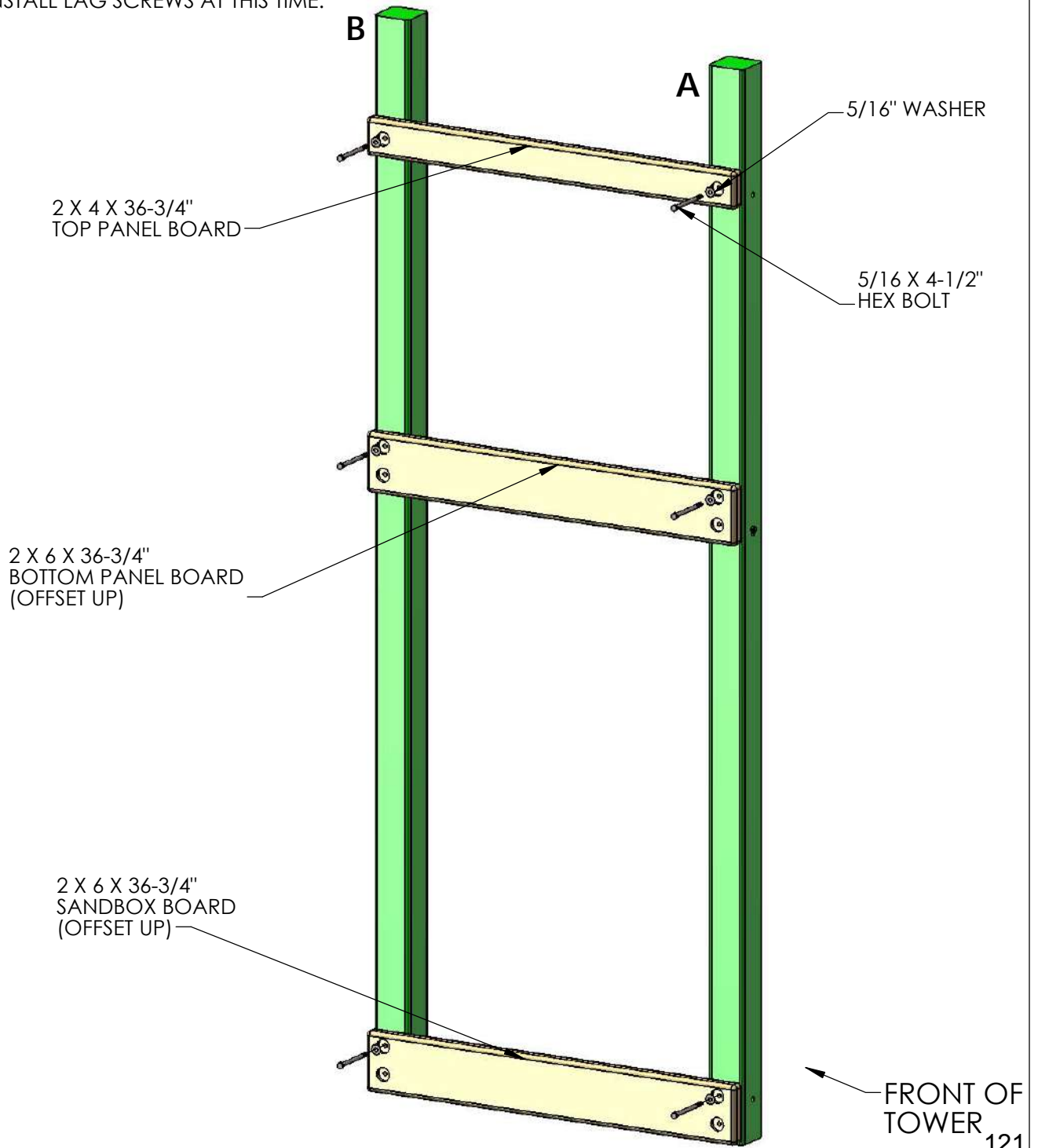

STEP 4: DECK SUPPORTS

YOU WILL NEED AN EXTRA PERSON FOR THIS STEP.

1: WITH HELP, STAND UP THE LEFT AND RIGHT SIDE ASSEMBLIES.

2: FASTEN THE 2 X 4 X 36-3/4" DECK SUPPORTS TO THE HOLES AT 54-1/2" WITH 5/16 X 4-1/2" HEX BOLTS AND 5/16" WASHERS FROM THE INSIDE OF THE CORNER POST.

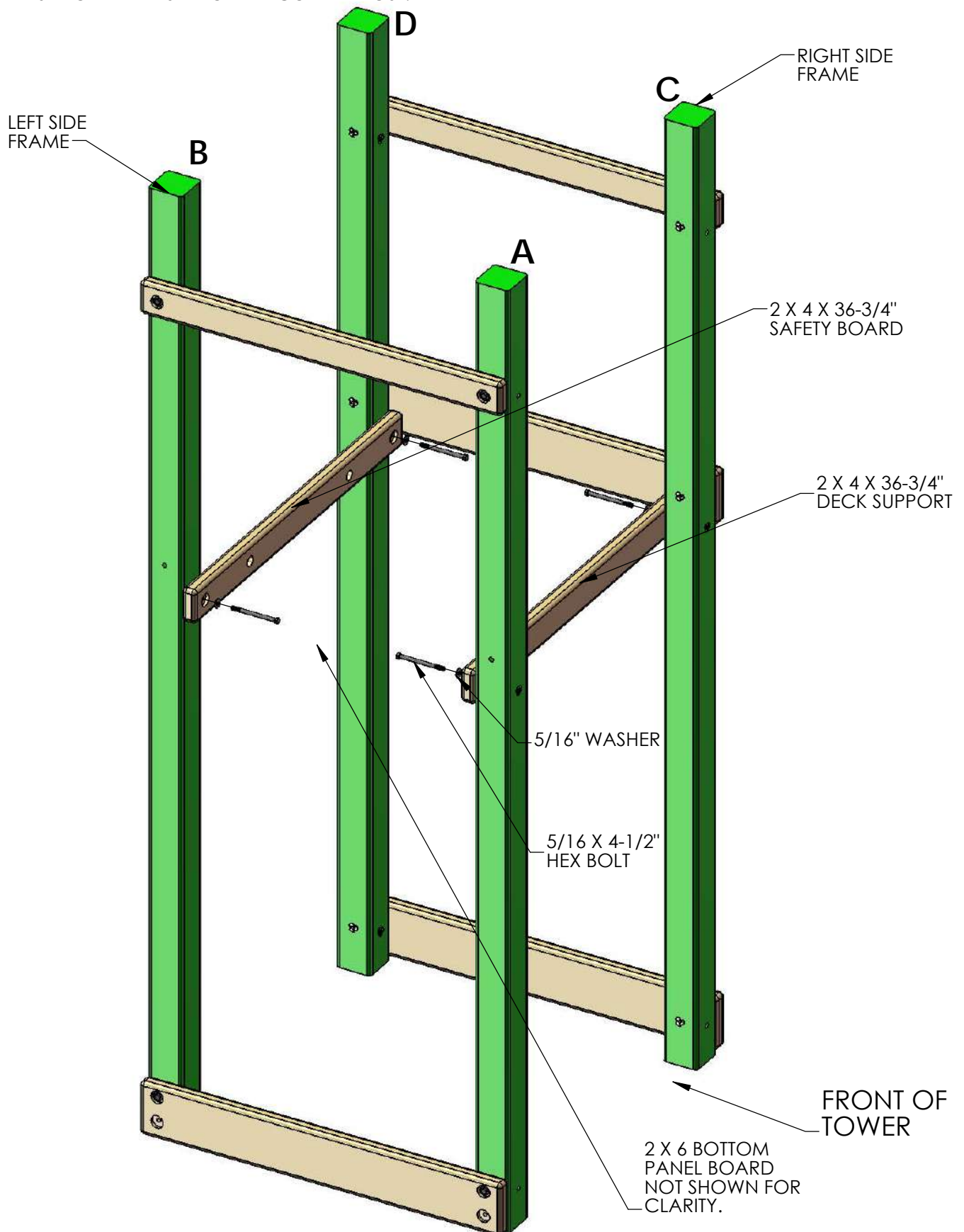

STEP 5: FRONT FRAME ASSEMBLY

1: PLACE THE 2 X 6 X 36-3/4" SANDBOX BOARD ON THE FRONT OF THE CORNER POSTS. THE HOLES IN THE SANDBOX BOARD SHOULD BE OFFSET DOWN.

2: USE 5/16 X 4-1/2" HEX BOLTS AND 5/16" WASHERS TO ATTACH THE TOP HOLES OF THE SANDBOX BOARD TO THE T-NUTS INSTALLED ON THE CORNER POSTS. THE BOTTOM HOLES WILL BE USED LATER.

3: PLACE THE 2 X 4 X 36-3/4" TOP PANEL BOARD ON THE FRONT OF THE CORNER POSTS.

4: USE 5/16 X 4-1/2" HEX BOLTS AND 5/16" WASHERS TO ATTACH THE HOLES OF THE TOP PANEL BOARD TO THE T-NUTS INSTALLED ON THE CORNER POSTS.

5: DO NOT INSTALL LAG SCREWS AT THIS TIME.

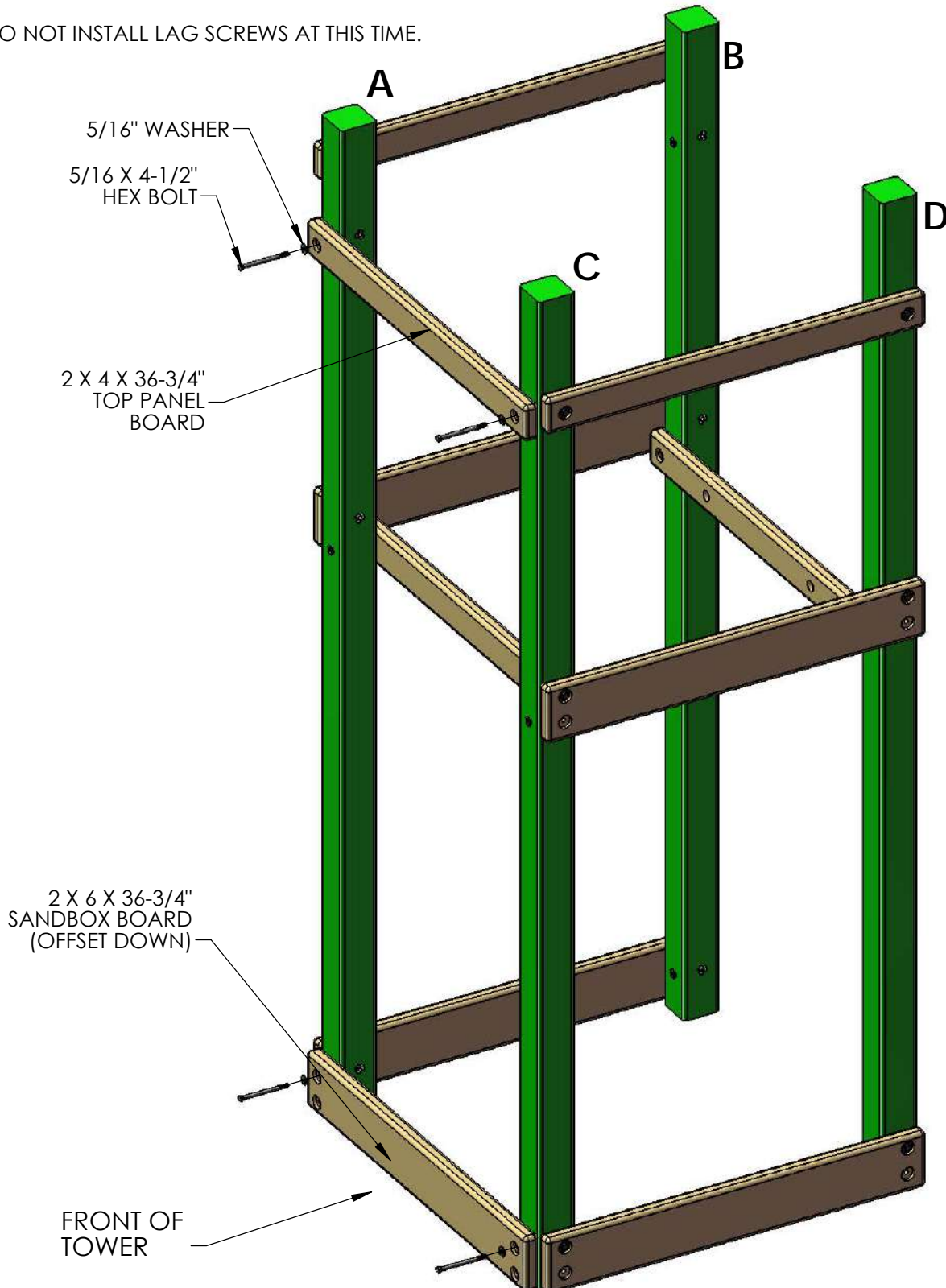

STEP 6: REAR FRAME ASSEMBLY

1: PLACE THE 2 X 6 X 36-3/4" SANDBOX BOARD ON THE REAR OF THE CORNER POSTS. THE HOLES IN THE SANDBOX BOARD SHOULD BE OFFSET DOWN.

2: USE 5/16 X 4-1/2" HEX BOLTS AND 5/16" WASHERS TO ATTACH THE TOP HOLES OF THE SANDBOX BOARD TO THE T-NUTS INSTALLED ON THE CORNER POSTS. THE BOTTOM HOLES WILL BE USED LATER.

3: PLACE THE 2 X 4 X 36-3/4" TOP PANEL BOARD ON THE REAR OF THE CORNER POSTS.

4: USE 5/16 X 4-1/2" HEX BOLTS AND 5/16" WASHERS TO ATTACH THE HOLES OF THE TOP PANEL BOARD TO THE T-NUTS INSTALLED ON THE CORNER POSTS.

5: DO NOT INSTALL LAG SCREWS AT THIS TIME.

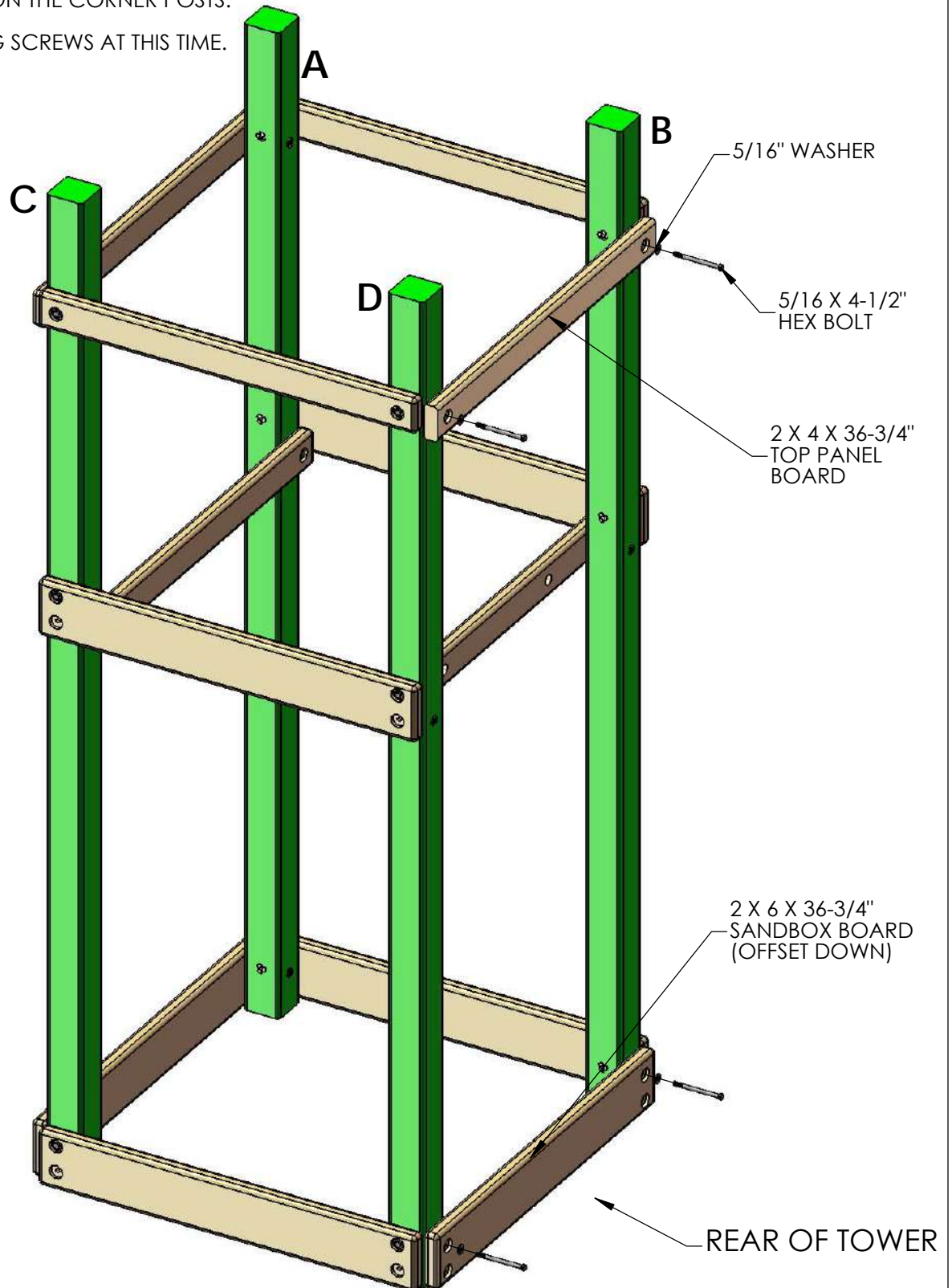

STEP 7: LAG SCREWS

1: PLACE THE FRAME IN ITS FINAL POSITION AND FOLLOW THE PROCEDURES AT THE FRONT OF THE MANUAL TO LEVEL AND SQUARE THE STRUCTURE. TO SQUARE AND LEVEL THE DECK OF THE TOWER TO THE DECK OF THE FORT PLACE A DECK BOARD ACROSS THE 2 X 4'S. THEN PLACE A 2 X 4 X 66" BRIDGE RAIL ON TOP OF THE DECK BOARD AND ON TOP OF THE FORT DECK. PLACE A LEVEL ON TOP OF THE 66" BRIDGE RAIL, THEN MAKE THE DECKS LEVEL TO ONE ANOTHER.

2: ONCE THE FRAME IS LEVEL, SQUARE, AND SET INTO POSITION; GO BACK AND INSERT THE 5/16 X 3-1/2" LAG SCREWS AND 5/16" WASHERS IN THE REMAINING HOLES OF THE 2 X 6 PARTS SHOWN BELOW. NOTE: THERE WILL NOT BE ANY PREDRILLED HOLES IN THE CORNER POSTS FOR THE LAG SCREWS.

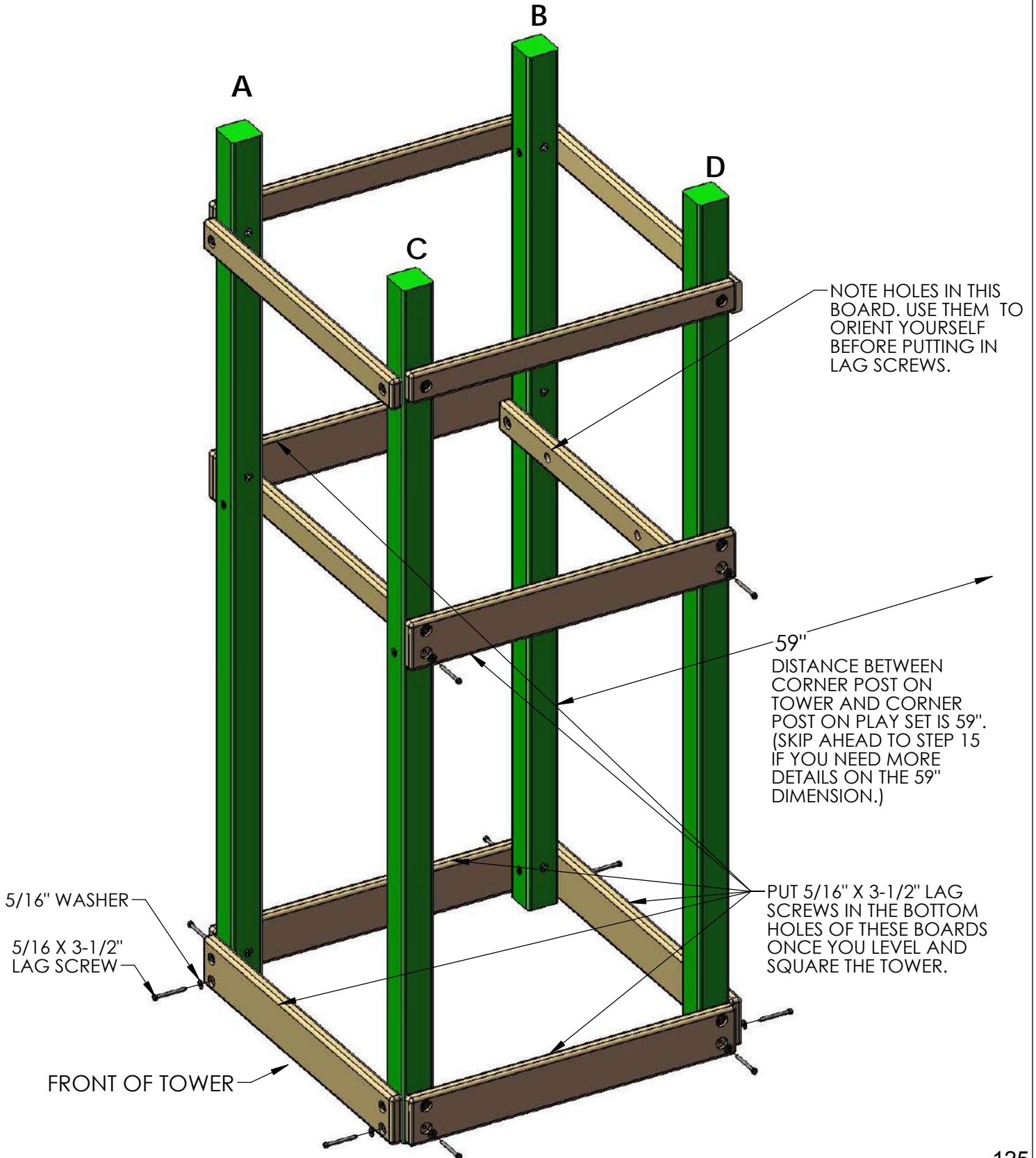

STEP 8: DECK BOARDS

THE FOLLOWING STEP IS RECOMMENDED TO PREVENT POSSIBLE SPLITS IN THE WOOD

1: PRE-DRILL THE ENDS OF THE DECK SPACERS AND DECKBOARDS TO PREVENT INSTALLATION DAMAGE. PRE-DRILL BOTH ENDS WITH A 1/8" DRILL BIT USING THE DIMENSIONS SHOWN BELOW.

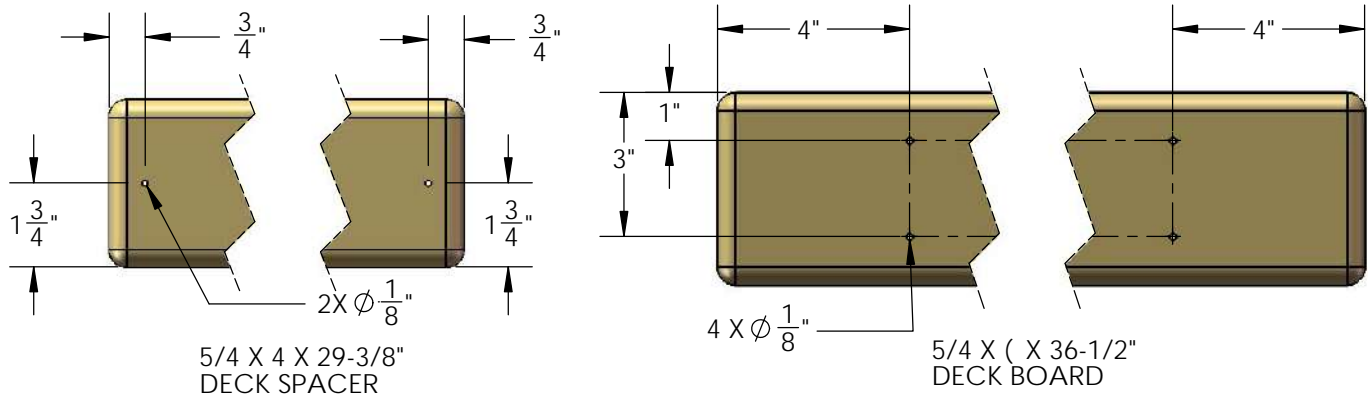

2: PLACE THE 5/4 X 4 X 29-3/8" DECK SPACERS BETWEEN THE CORNER POSTS. MAKE EACH DECK SPACER FLUSH TO THE INSIDE SURFACE OF THE 2 X 6. ATTACH EACH DECK SPACER TO THE DECK SUPPORTS WITH TWO 2" WOOD SCREWS. NOTE THE TOP OF THE SCREW HEAD SHOULD BE FLUSH WITH THE TOP OF THE DECK SPACER.

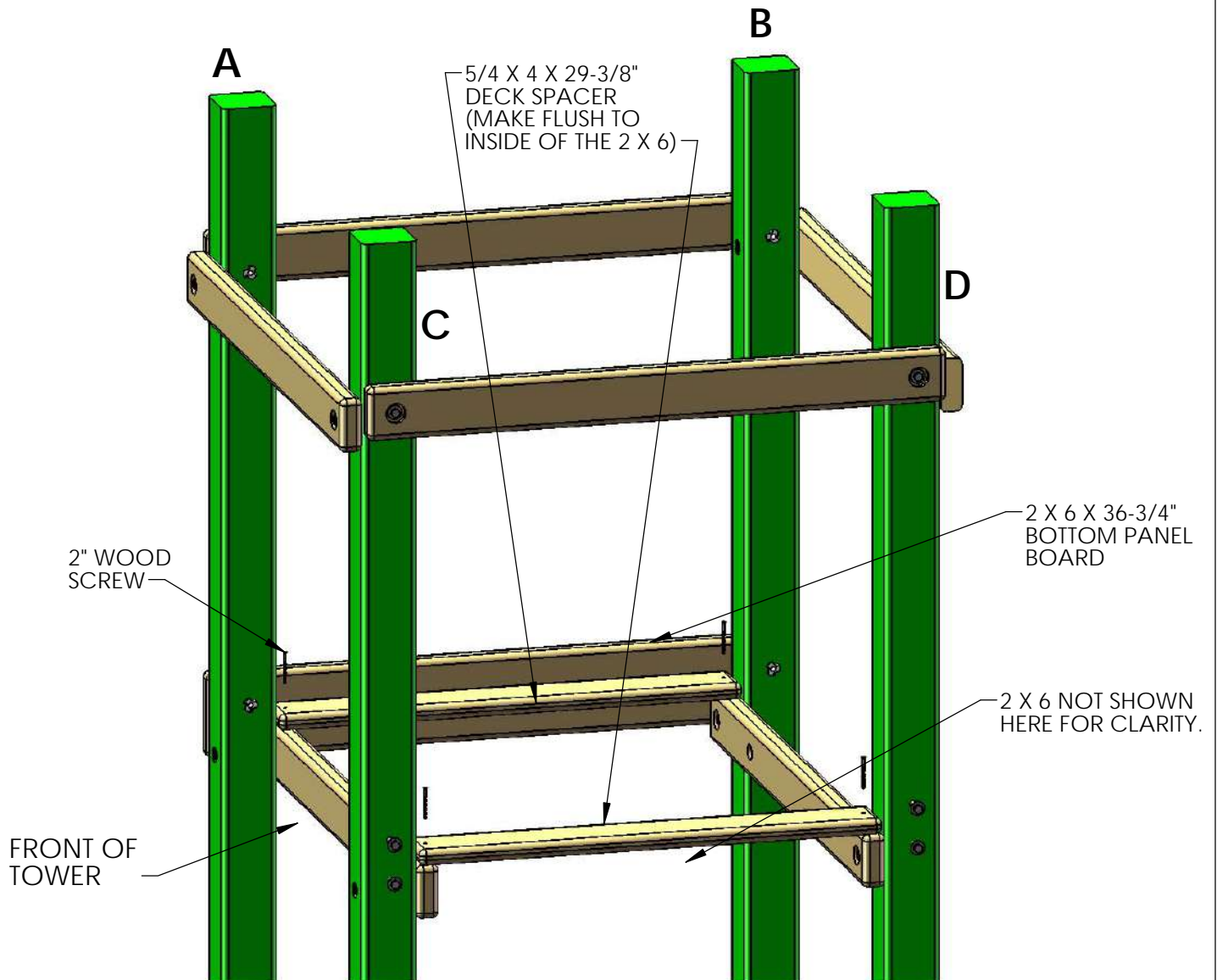

STEP 9: FRONT FACE BOARD

1: PLACE THE 5/4 X 4 X 36-11/16" DECK BOARDS ON TOP OF THE DECK SUPPORTS. DO NOT FASTEN THE DECK BOARDS AT THIS TIME.

2: PLACE THE 2 X 4 X 36-3/4" BOTTOM PANEL BOARD AGAINST THE FRONT CORNER POSTS, AND LEVEL THE TOP OF THE BOARD WITH THE TOP OF THE DECK BOARDS.

3: FASTEN THE BOTTOM PANEL BOARD TO THE CORNER POSTS WITH 5/16 X 3-1/2" LAG SCREWS WITH 5/16" WASHERS.

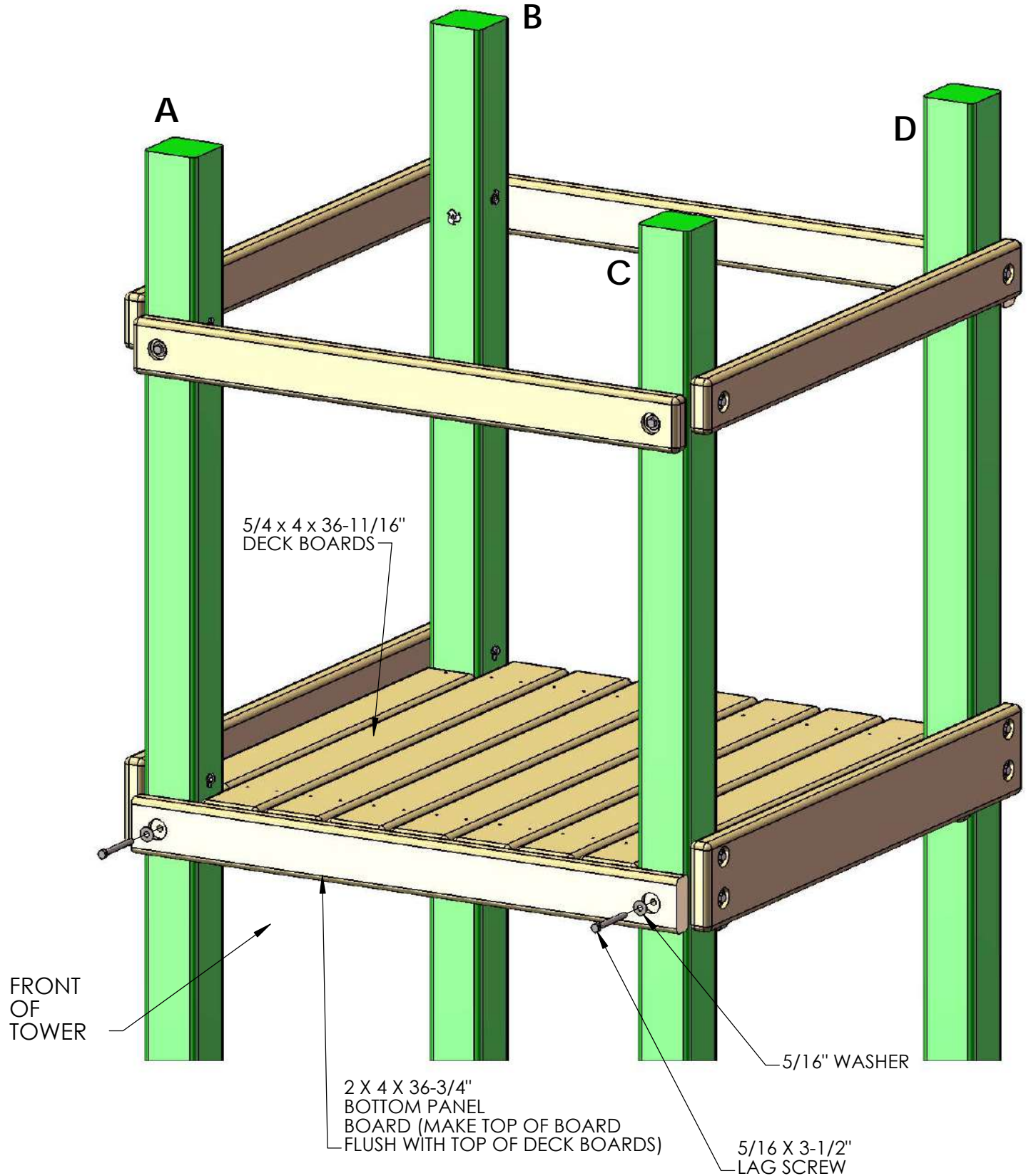

STEP 10: DECK

1: INSTALL THE 5/4 X 4 X 36-11/16" DECK BOARDS. LEAVE A UNIFORM (APPROXIMATELY 1/4") SPACE BETWEEN THE DECK BOARDS. ATTACH THE DECK BOARDS TO THE DECK SUPPORTS WITH WITH 2" WOOD SCREWS.

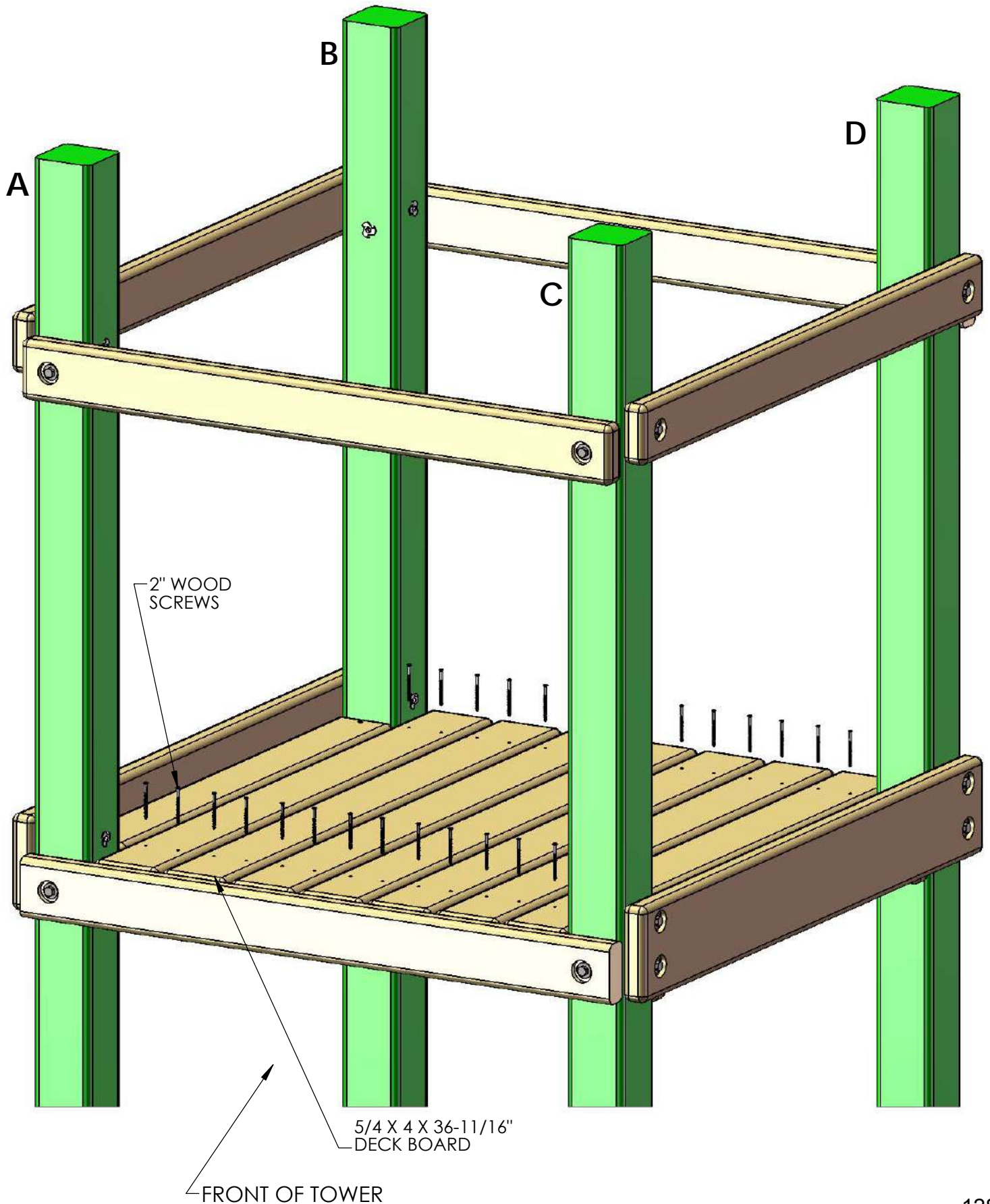

STEP 11: REAR BOTTOM PANEL BOARD

1: PLACE THE 2 X 4 X 36-3/4" SAFETY BOARD WITH CHAIN HOLES AGAINST THE REAR CORNER POSTS, AND LEVEL THE TOP OF THE BOARD WITH THE TOP OF THE DECK BOARDS.

2: FASTEN THE SAFETY BOARD TO THE CORNER POSTS WITH 5/16 X 3-1/2" LAG SCREWS WITH 5/16" WASHERS.

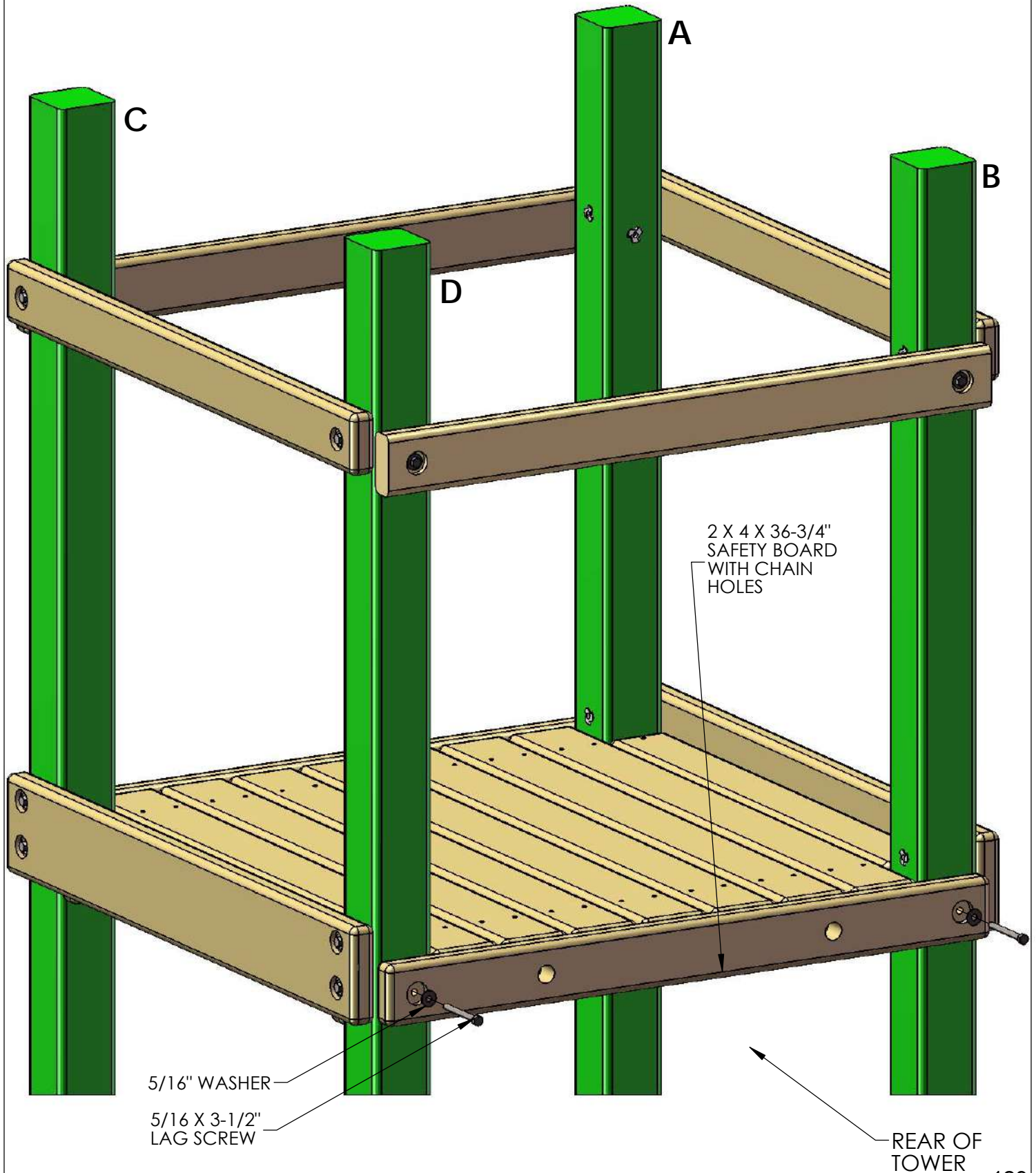

STEP 12: PANEL SLATS

1: FIND TEN 5/4 X 3 X 28-1/2" PANEL SLATS.

2: PRE-DRILL THE PANEL SLATS 1" FROM EACH END ON CENTER WITH A 1/8" DRILL BIT. (SEE TOP LEFT PICTURE BELOW)

3: INSTALL THE FIRST PANEL SLAT 2-1/2" FROM THE CORNER POST. THEN INSTALL THE REMAINING FOUR PANEL SLATS 2-7/8" APART AS SHOWN IN THE PICTURE AT THE BOTTOM LEFT BELOW.

4: ATTACH THE PANEL SLATS WITH 2" WOOD SCREWS IN THE PRE-DRILLED HOLES TO THE RIGHT SIDE OF THE TOWER.

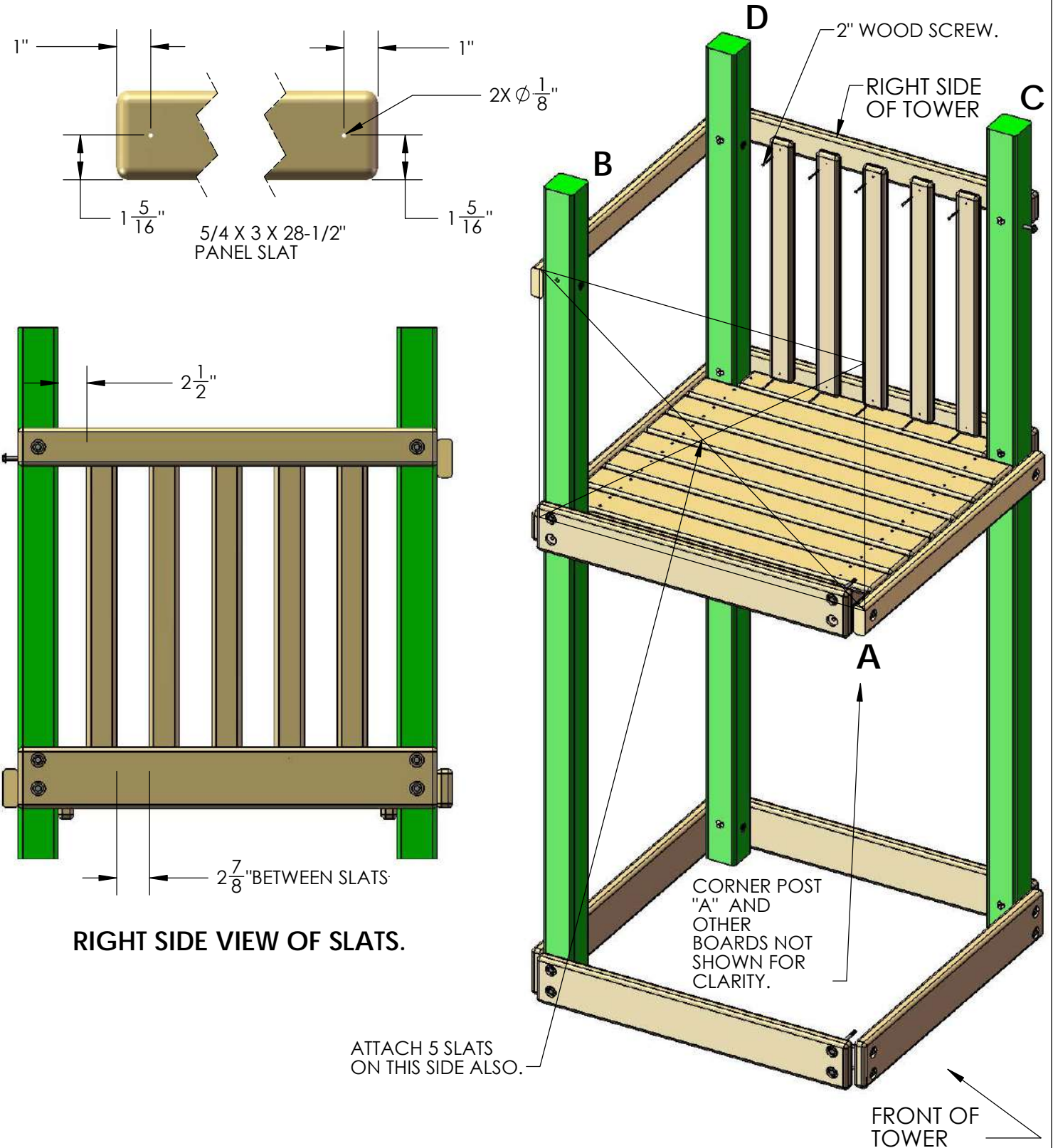

STEP 13: BRIDGE RAILS

- 1: PLACE THE TOP SURFACE OF THE UPPER TWO 2 X 4 X 66" BRIDGE RAILS 5-1/2" BENEATH THE TOP SURFACE OF THE TOP PANEL BOARD. THE COUNTERSUNK HOLE IN THE END OF THE BRIDGE RAIL SHOULD FACE THE INSIDE. FASTEN THE BRIDGE RAIL TO THE CORNER POST WITH 5/16" X 3-1/2" LAG SCREWS WITH 5/16" WASHERS.
- 2: MEASURE 16" FROM THE TOP OF EACH BRIDGE RAIL AND MAKE A PENCIL MARK ON THE INSIDE OF THE CORNER POSTS.
- 3: PLACE THE BOTTOM OF EACH LOWER 2 X 4 X 66" BRIDGE RAIL ON THE MARK ON THE CORNER POST. FASTEN EACH BRIDGE RAIL TO THE CORNER POST WITH 5/16" X 3-1/2" LAG SCREWS WITH 5/16" WASHERS.

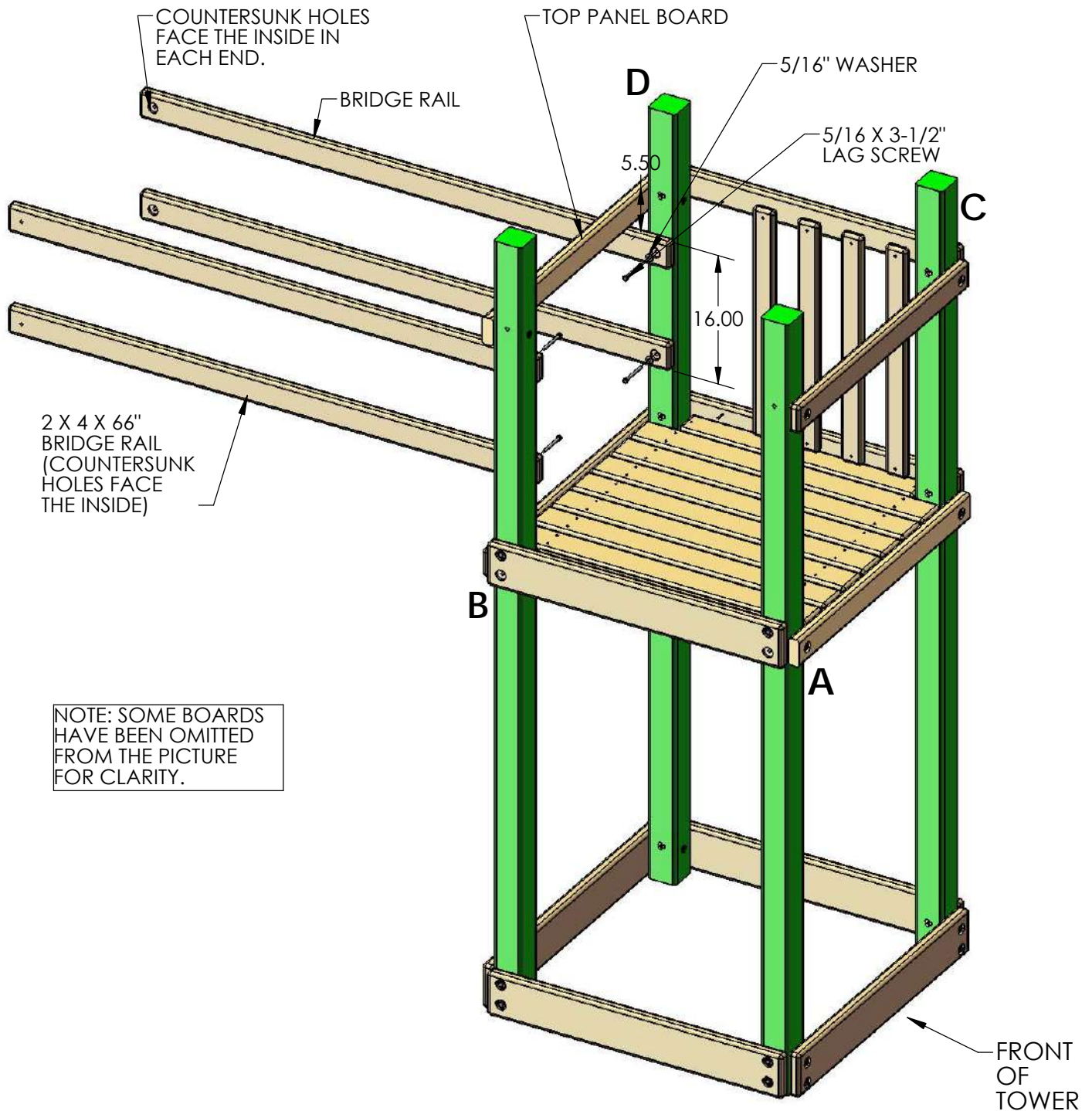

STEP 14: BRIDGE RAILS TO PLAY SET

1: PLACE THE BRIDGE RAILS AGAINST THE GREEN CORNER POST AND CENTER CORNER POST ON THE PLAY SET.

2: LEVEL EACH TOP BRIDGE RAIL AND ATTACH THEM TO THE CORNER POSTS WITH 5/16" X 3-1/2" LAG SCREWS AND 5/16" WASHERS.

3: MAKE THE BOTTOM OF EACH LOWER BRIDGE RAIL 16" FROM THE TOP OF THE TOP BRIDGE RAIL.

4: ATTACH EACH LOWER BRIDGE RAIL TO THE CORNER POSTS WITH 5/16" X 3-1/2" LAG SCREWS AND 5/16" WASHERS.

5: ATTACH 5/4 X 3 X 28-1/4" PANEL SLAT TO ROPE LADDER SUPPORT AND FRONT FACE BOARD, NEXT TO THE BRIDGE RAIL WITH 2" WOOD SCREWS.

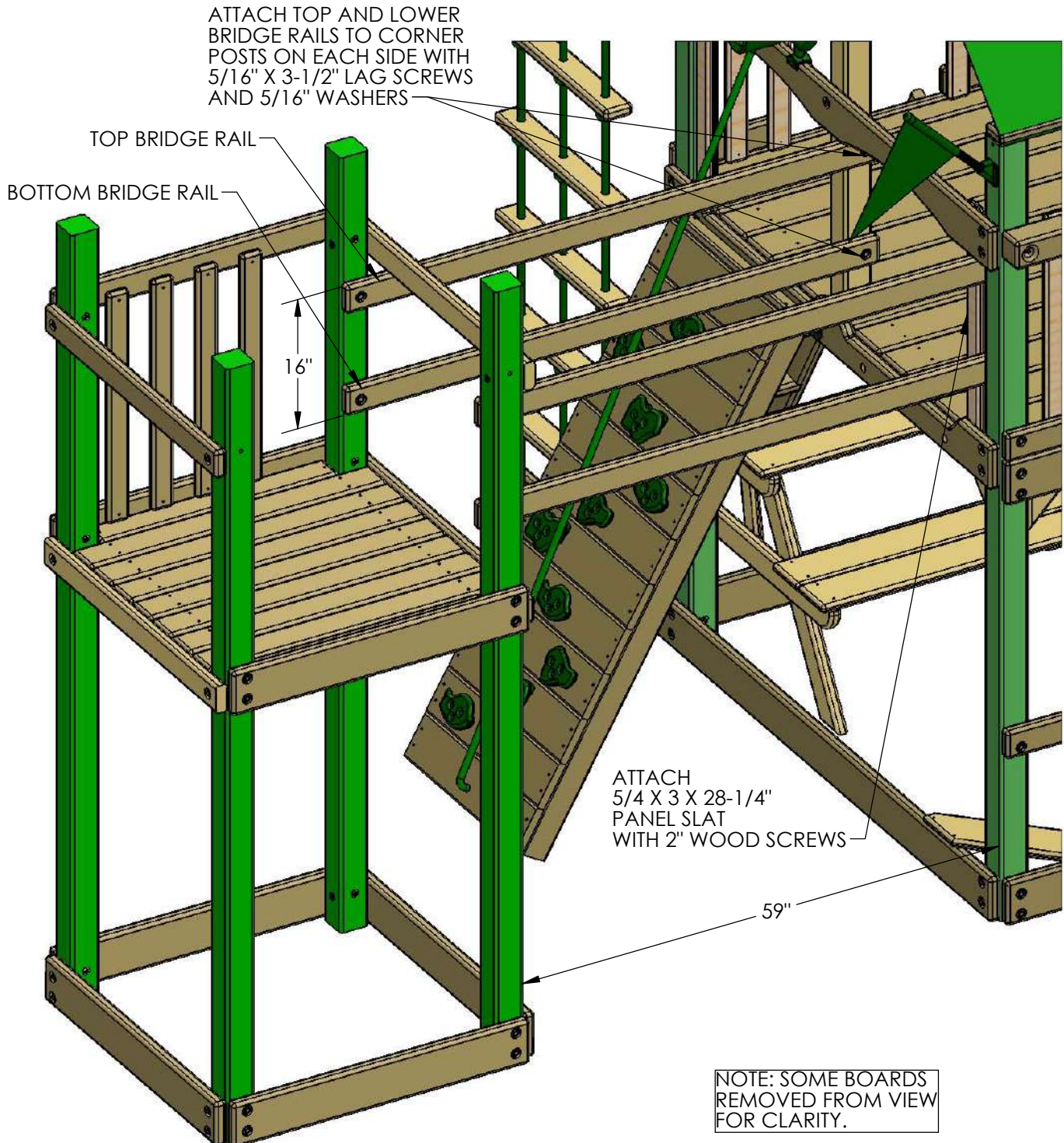

STEP 15: BRIDGE RAIL SLATS

1. PRE-DRILL TWENTY $5/4 \times 3 \times 16$ " BRIDGE RAIL SLATS ON EACH END WITH A $1/8$ " DRILL BIT. (SEE TOP IMAGE BELOW)
2. PLACE THE BRIDGE RAIL SLATS 3" FROM THE FACE OF THE CORNER POSTS, AND ATTACH WITH 2" WOOD SCREWS. THE SLATS WILL MOUNT ON THE OUTSIDE OF THE BRIDGE RAILS.
3. ATTACH THE REMAINING SLATS TO THE UNIT WITH 3" SPACING BETWEEN THE SLATS.

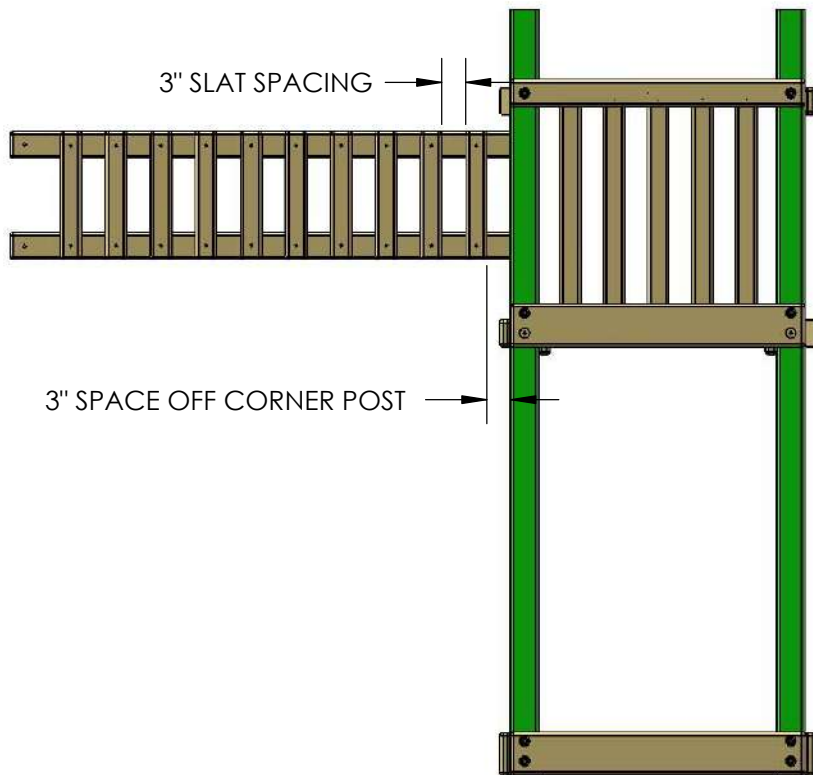
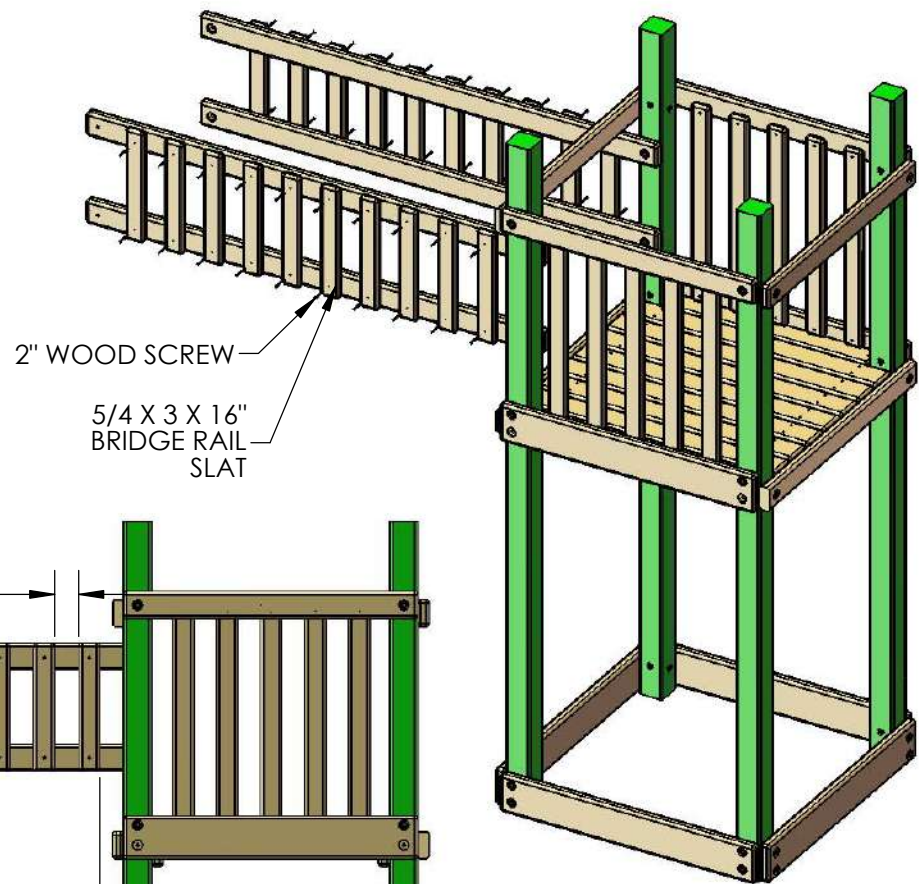
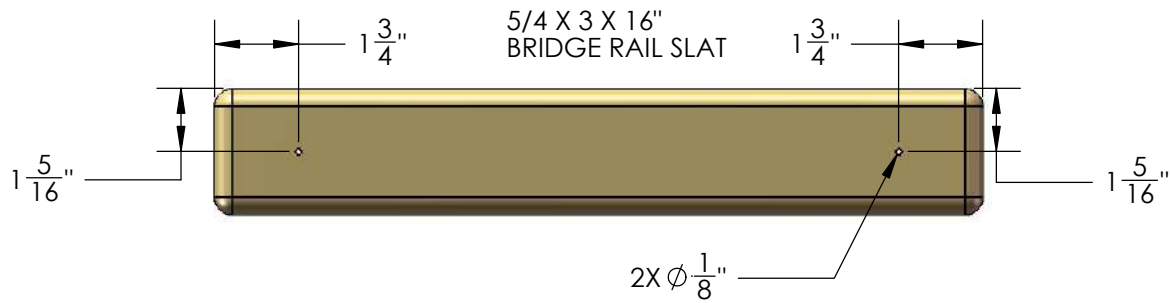

LEFT SIDE VIEW

STEP 16: BRIDGE DECK AND CHAIN ASSEMBLY

1: FIND FIFTEEN 2 X 4 X 29" BRIDGE DECK BOARDS AND INSERT T-NUTS INTO THE PRE-DRILLED HOLES. USE A HAMMER TO SEAT THE T-NUTS INTO THE BOARDS.

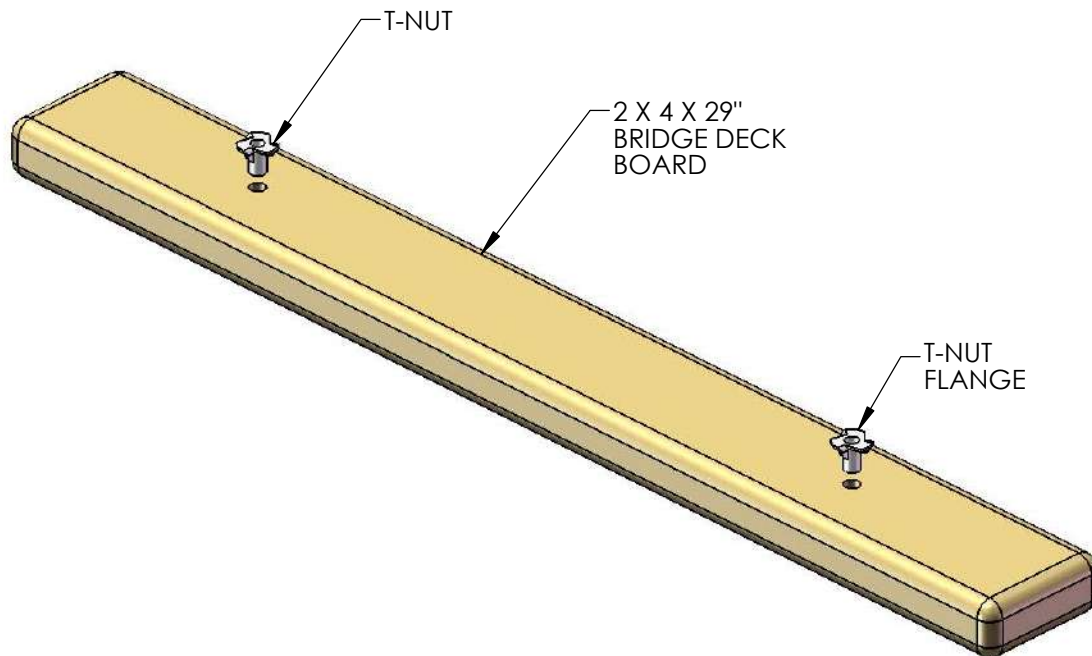

2: FLIP ALL 15 BRIDGE DECK BOARDS OVER SO THAT THE FLANGE OF THE T-NUT IS FACING DOWN. LAY THE BRIDGE DECK BOARDS OUT ON A FLAT SURFACE AS SHOWN BELOW.

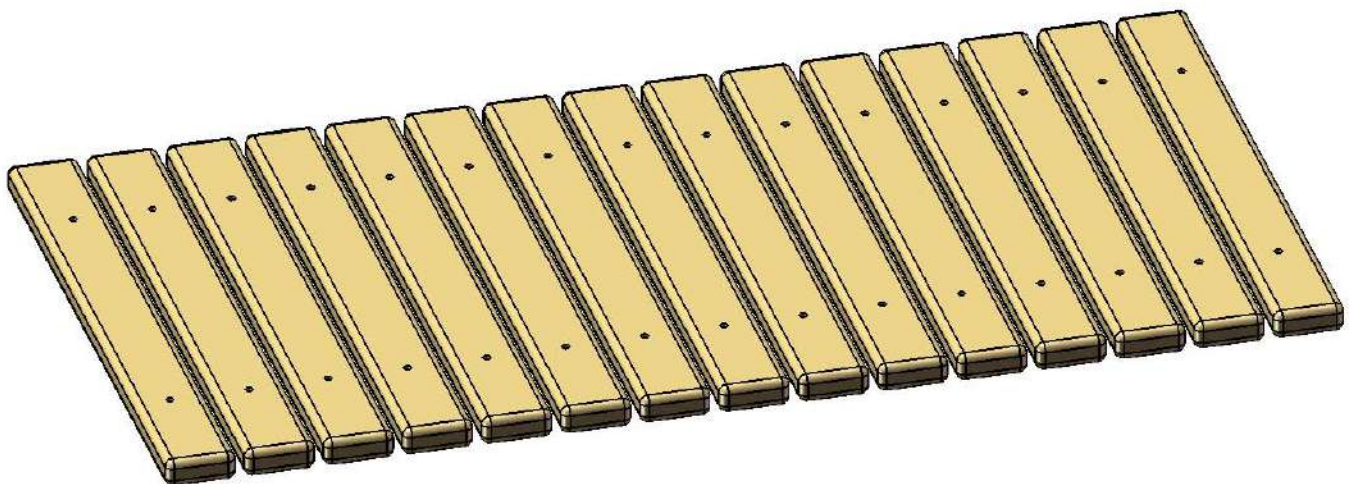

STEP 17: BRIDGE DECK AND CHAIN ASSEMBLY

- 1: LOCATE TWO 96" CHAIN SECTIONS THAT SHIPPED WITH THE CLATTER BRIDGE.
- 2: PLACE THE CHAINS OVER THE HOLES IN THE BRIDGE DECK BOARDS AS SHOWN BELOW.
- 3: LINE UP THE 18TH LINK IN THE CHAINS WITH THE FIRST BRIDGE DECK BOARD HOLES.

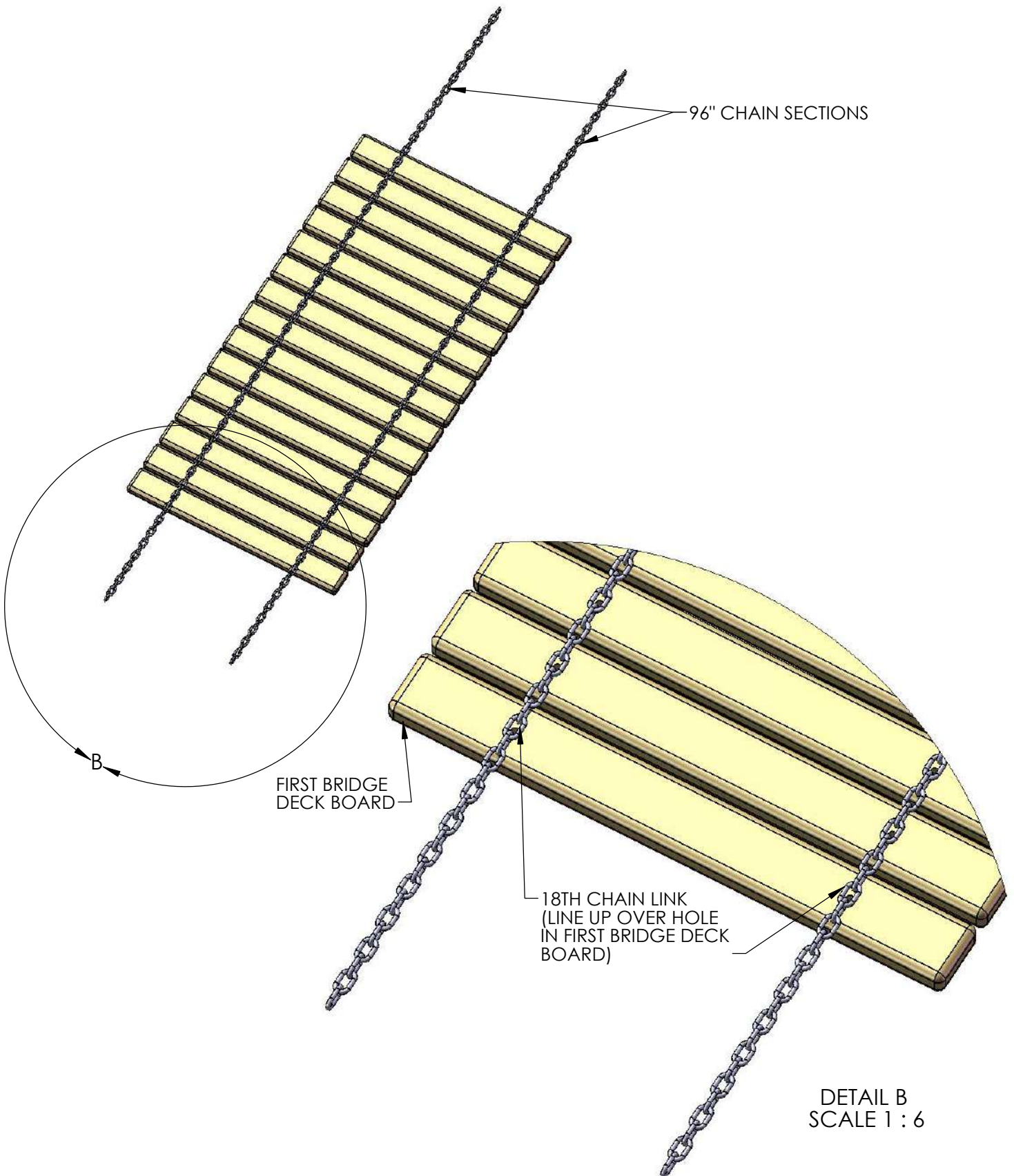

STEP 18: BRIDGE DECK AND CHAIN ASSEMBLY

1: PLACE A 5/16" WASHER BETWEEN THE 18TH CHAIN LINK AND THE BRIDGE DECK BOARD.

2: PLACE A 5/16" X 1-3/4" HEX BOLT WITH 5/16" WASHER THROUGH THE 18TH CHAIN LINK, THEN THROUGH THE 5/16" WASHER, THEN THROUGH THE HOLE IN THE BRIDGE DECK BOARD AND SCREW IT INTO THE T-NUT. TIGHTEN THE BOLT BUT NOT SO TIGHT THAT YOU CRACK THE WOOD.

3: COUNT OVER 4 CHAIN LINKS FROM THE LAST HEX BOLT. AT THIS CHAIN LINK PLACE A 5/16" WASHER BETWEEN THE CHAIN LINK AND THE BRIDGE DECK BOARD. NOTE THAT THREE EMPTY CHAIN LINKS ARE BETWEEN THE BOLTS.

4: PLACE A 5/16" X 1-3/4" HEX BOLT WITH 5/16" WASHER THROUGH THE CHAIN LINK, THEN THROUGH THE 5/16" WASHER, THEN THROUGH THE HOLE IN THE BRIDGE DECK BOARD AND SCREW IT INTO THE T-NUT. TIGHTEN THE BOLT BUT NOT SO TIGHT THAT YOU CRACK THE WOOD.

5: REPEAT SUBSTEPS 3 & 4 UNTIL YOU HAVE SECURED THE CHAIN TO THE BRIDGE DECK BOARDS ALONG ONE SIDE. THEN START OVER WITH THE OTHER CHAIN AND REPEAT THIS ENTIRE PROCESS.

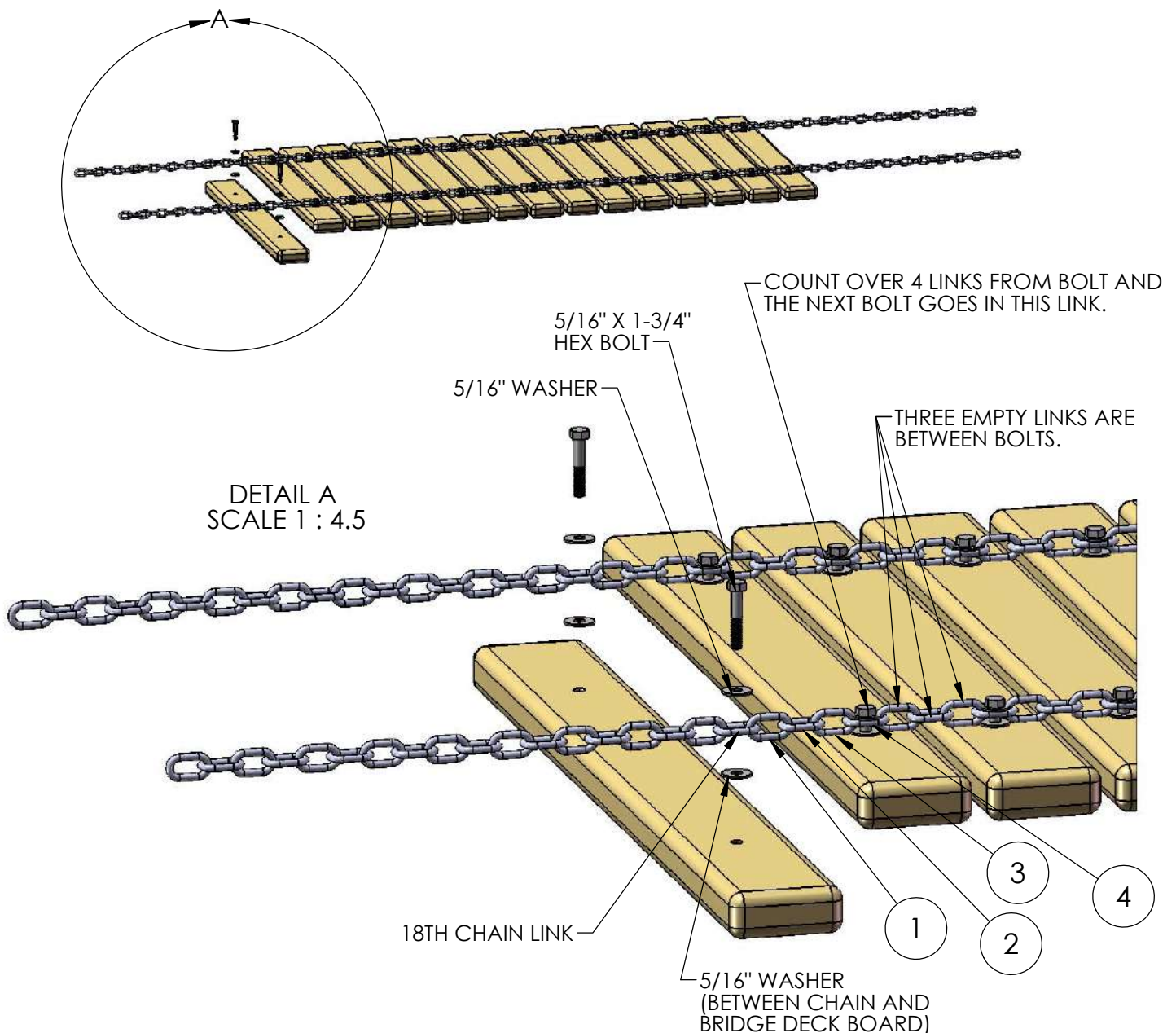

STEP 19: BRIDGE DECK/CHAIN INSTALLATION

1: LAY THE BRIDGE DECK/CHAINS ASSEMBLY BETWEEN THE PLAY SET AND THE TOWER WITH THE CHAINS FACING THE GROUND. THREAD THE CHAIN ENDS IN THE BRIDGE DECK ASSEMBLY THROUGH THE HOLES IN THE BOTTOM PANEL BOARD AND DECK SUPPORT BOARD ON THE TOWER.

2: THERE SHOULD BE AT LEAST A 1" TO 1-3/4" GAP BETWEEN THE BRIDGE DECK BOARD AND THE BOTTOM PANEL BOARD ON THE TOWER. THIS MEANS THAT YOU WILL HAVE TO CONNECT THE ENDS OF THE CHAINS IN A MANNER TO ACHIEVE THE CORRECT GAP. GO UNDERNEATH THE TOWER DECK AND USE A QUICK LINK TO ATTACH THE CHAINS TOGETHER. IF YOU HAVE LOOSE ENDS OF THE CHAINS HANGING DOWN THREAD THEM THROUGH THE QUICK LINK TO KEEP THEM UP AND OUT OF THE WAY.

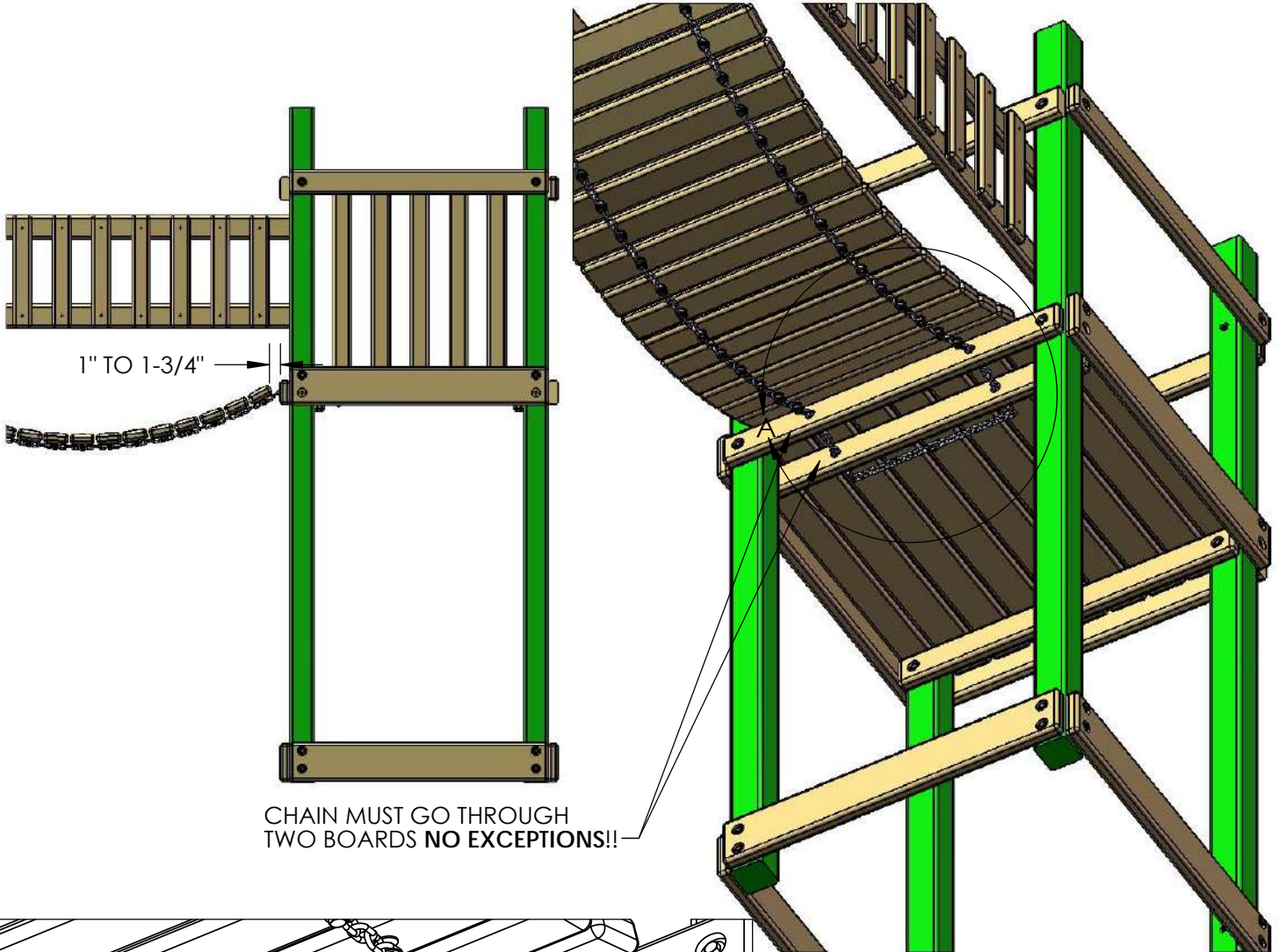

1" TO 1-3/4"

CHAIN MUST GO THROUGH TWO BOARDS NO EXCEPTIONS!!

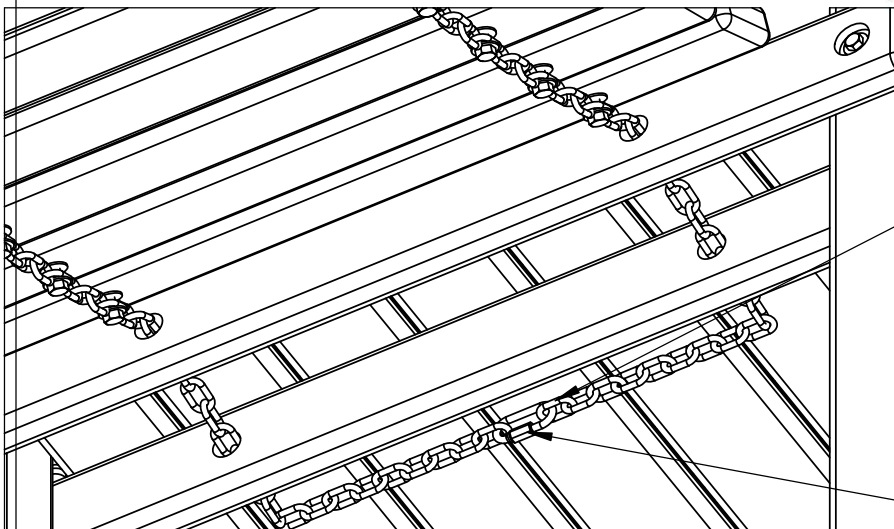

NOTE: TO ACHIEVE THE CORRECT GAP YOU MAY NOT BE CONNECTING THE END LINK OF EACH CHAIN. FOR EXAMPLE YOU MAY HAVE TO CONNECT THE SECOND, THIRD OR FORTH LINKS TOGETHER.

QUICK LINK

DETAIL A
SCALE 1 : 6

STEP 20: BRIDGE DECK/CHAIN INSTALLATION

1: TWO PEOPLE MAY BE REQUIRED FOR THIS STEP.

2: THERE SHOULD BE AT LEAST A 1" TO 1-3/4" GAP BETWEEN THE BRIDGE DECK BOARD AND THE FRONT FACE BOARD ON THE PLAY SET. THIS MEANS THAT YOU WILL HAVE TO CONNECT THE ENDS OF THE CHAINS IN A MANNER TO ACHIEVE THE CORRECT GAP. IN ORDER TO ACHIEVE THE GAP YOUR ASSISTANT MAY HAVE TO LIFT UP THE BRIDGE DECK ASSEMBLY WHILE YOU CONNECT THE CHAINS TOGETHER WITH THE QUICK LINK UNDER THE PLAY SET DECK. IF YOU HAVE LOOSE ENDS OF THE CHAINS HANGING DOWN THREAD THEM THROUGH THE QUICK LINK TO KEEP THEM UP AND OUT OF THE WAY.

3: THREAD THE CHAIN ENDS IN THE BRIDGE DECK ASSEMBLY THROUGH THE HOLES IN THE FRONT FACE BOARD AT THE FRONT OF THE PLAY SET. THEN THREAD EACH CHAIN THROUGH THE HOLES IN THE DECK SUPPORT. CONNECT THE LEFT CHAIN TO THE RIGHT CHAIN WITH A QUICK LINK.

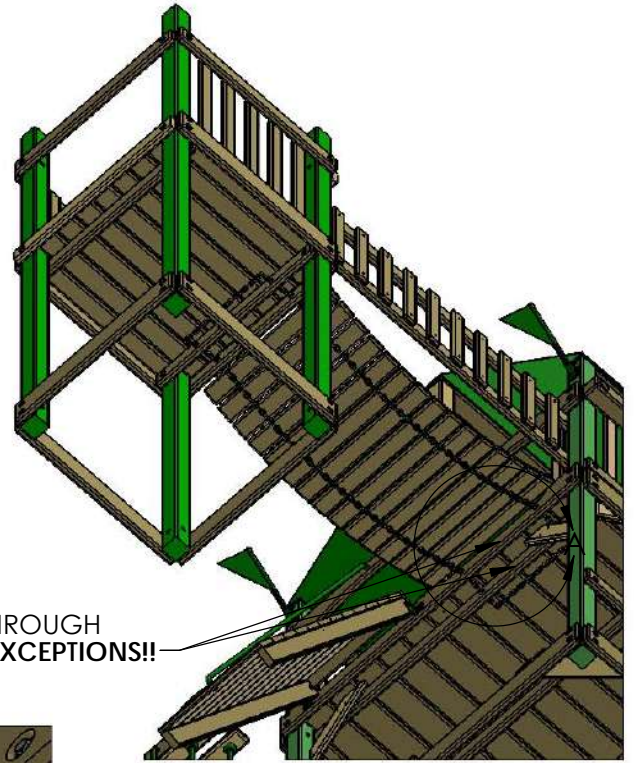
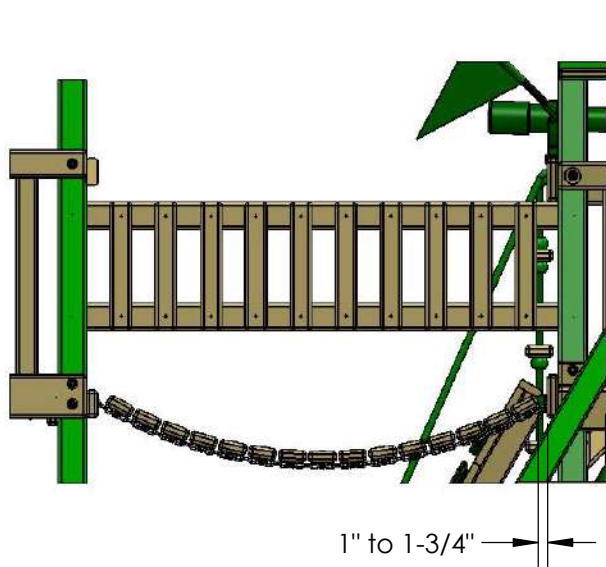

CHAIN MUST GO THROUGH TWO BOARDS NO EXCEPTIONS!!



FRONT FACE BOARD

DECK SUPPORT

NOTE: TO ACHIEVE THE CORRECT GAP YOU MAY NOT BE CONNECTING THE END LINK OF EACH CHAIN. FOR EXAMPLE YOU MAY HAVE TO CONNECT THE SECOND, THIRD, FORTH LINKS, ETC. TOGETHER.

QUICK LINK

STEP 21: VERTICAL TARP SUPPORTS

1: PLACE THE 2 X 4 X 33" VERTICAL TARP SUPPORTS ON THE INSIDE OF THE TOP PANEL BOARDS. THE END OF EACH VERTICAL TARP SUPPORT SHOULD BE FLUSH TO THE BOTTOM OF THE TOP PANEL BOARD. CENTER EACH VERTICAL TARP SUPPORT WITH THE CENTER OF THE TOP PANEL BOARD. SQUARE EACH VERTICAL TARP SUPPORT TO THE TOP PANEL BOARD.

2: ATTACH THE VERTICAL TARP SUPPORTS TO THE TOP PANEL BOARDS WITH 2-1/2" WOOD SCREWS.

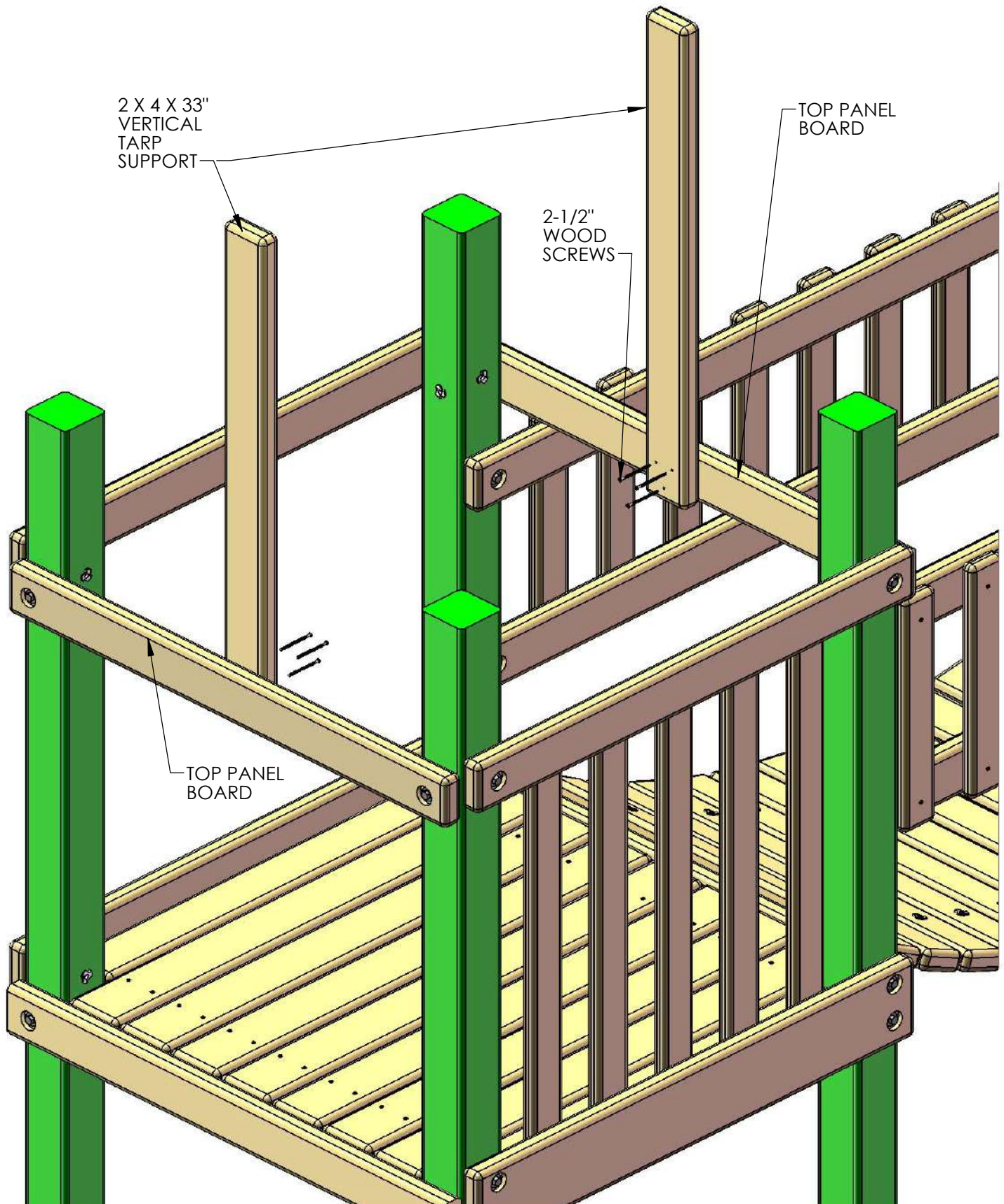

STEP 22: TARP BOARDS

1: LOCATE THREE 2 X 4 X 36-3/4" TARP BOARDS.

2: PLACE ONE TARP BOARD ON TOP OF THE VERTICAL TARP SUPPORTS. THE END OF THE TARP BOARD SHOULD BE FLUSH WITH THE SIDES OF THE VERTICAL TARPS SUPPORTS.

3: ATTACH THE TARP BOARD TO THE VERTICAL TARP SUPPORTS WITH 2-1/2" WOOD SCREWS.

4: PLACE ONE TARP BOARD ON TOP OF THE CORNER POSTS. THE TARP BOARD SHOULD BE FLUSH TO THE OUTSIDE OF THE CORNER POST.

5: ATTACH THE TARP BOARD TO THE TOP OF THE CORNER POSTS WITH 2-1/2" WOOD SCREWS.

6: REPEAT SUBSTEPS 4 AND 5 TO INSTALL THE LAST TARP BOARD.

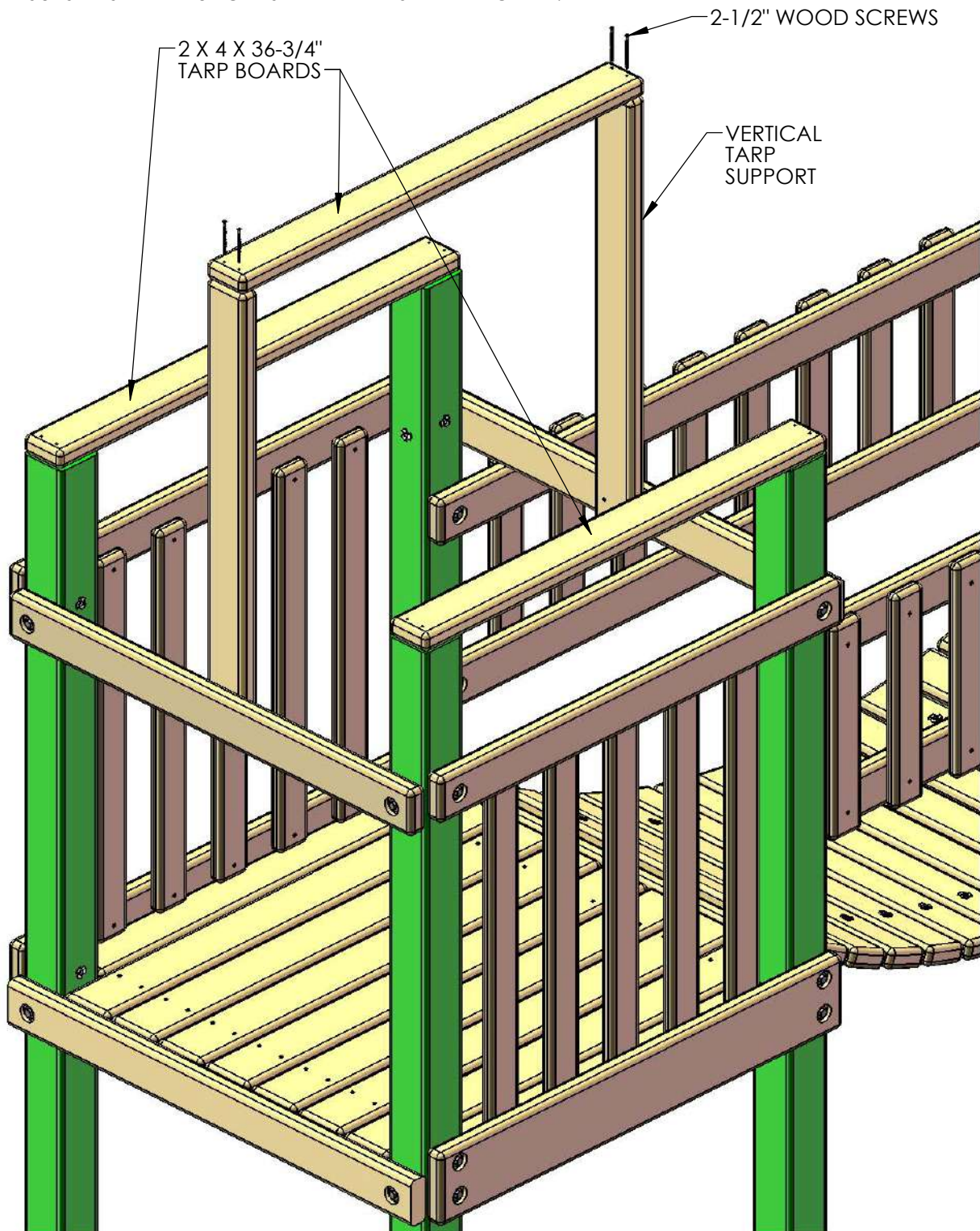

STEP 23: CLATTER BRIDGE TARP

1: LOCATE THE 34-1/4" X 57-1/2" CLATTER BRIDGE TARP.

2: PLACE THE TARP OVER THE TOP OF THE TARP BOARD ON TOP OF THE VERTICAL TARP SUPPORTS.

3: THE TARP WILL OVERLAP THE SIDE OF THE TARP BOARDS ON TOP OF THE CORNER POSTS.

4: ATTACH THE TARP THROUGH THE GROMMETS TO THE TARP BOARDS WITH #14 X 1-1/4" PAN HEAD SCREWS AND 1/4" FLAT WASHERS.

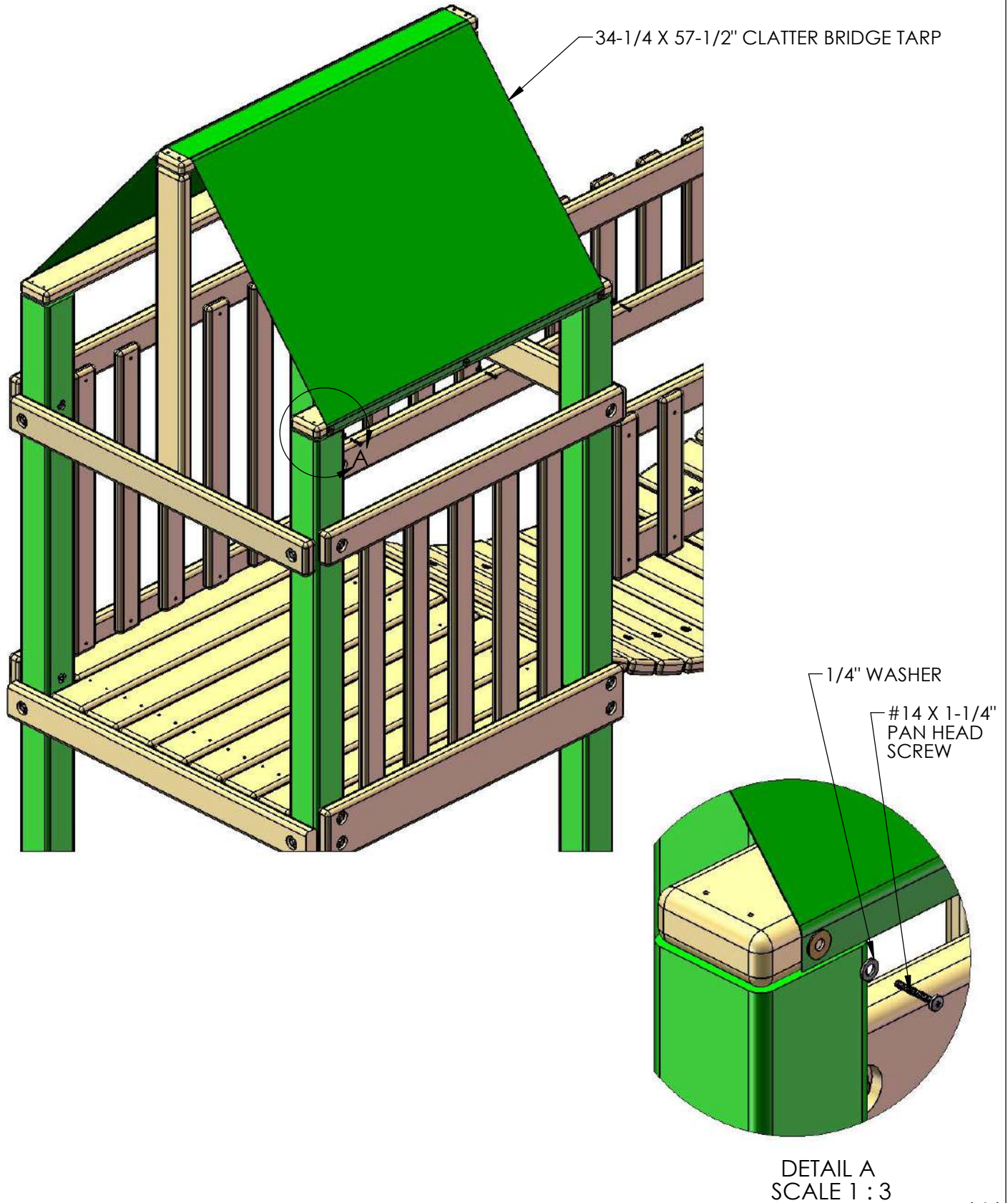

STEP 24: ATTACHING WAVE SLIDE

1: PLACE THE SLIDE IN THE OPENING OF THE CLATTER BRIDGE TOWER AS SHOWN WITH THE LIP OF THE SLIDE RESTING ON TOP OF THE DECK BOARDS.

2: PREDRILL 1/8" HOLES INTO THE DECK BOARDS AT THE SCREW LOCATIONS.

3: ATTACH THE SLIDE TO THE DECK BOARDS WITH FOUR #14 X 1-1/4" PAN HEAD SCREWS
****DO NOT OVERTIGHTEN****

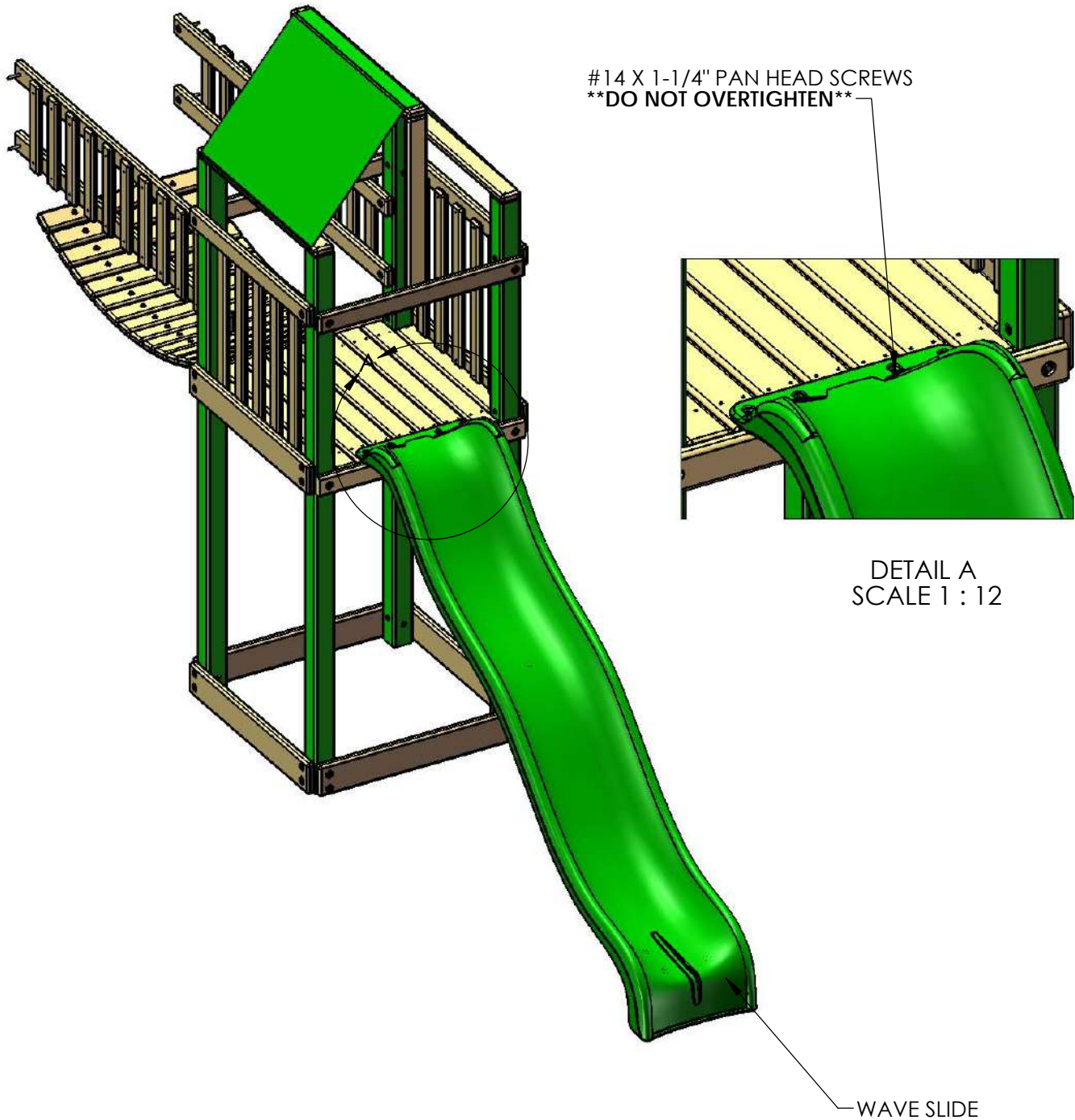

Leftover Parts List 1500KT Play Set

Our 1500 series play sets are modular and include parts to construct many different models. Some of these parts included with your play set will not be used because they are for a different model. The list below includes parts for your play set that will be leftover when construction is completed.

2 pieces 125-3-2825-PS Panel Slats (We include these parts in case the customer wishes to fill in the area where the Tic Tac Toe is located. Should the Tic Tac Toe become damaged the customer could use these boards to fill in the gap until a replacement Tic Tac Toe is ordered.)

2 pieces 2-4-7188-CTS Center Tarp Support-Front-Rear (This part is only used when a customer orders a single level play set. They go in the front/rear of the lower level deck)

1 piece 4-4-2900-CP Center Post (Only used for wood roof version with clatter bridge)

1 piece 125-3-2850 Panel Slat

4 pieces 125-3-3450-PS Panel Slat (These parts are used to close off the opening where the Scoop Slide is in the upper level if you have version I of this play set.)

1 piece 2-6-3043-SBPB Side Bottom Panel Board (This part is used to attach panel slats onto the upper level if you have version I of this play set.)

APPENDIX

(06-2004) Clatter Bridge Mesh Panels

Tools Required:

#2 Phillips Bit or screwdriver
1/8" drill bit
Pencil
Drill

Kit Contents:

2 - Green Mesh Panels 66" x 24"
44 - Phillips Pan Head Screws
5.5mm x 25.4mm long
44 - Washers 16mm O.D. X 7.1mm I.D.

Note: Your mesh panels will be completely green. The pictures below show white border and black mesh panels but they are solely for the purposes of demonstrating how the mesh should be installed.

- 1) Center the mesh on the inside of the lower clatter bridge rail. The top of the mesh border should be flush to the top of the clatter bridge rail. If you wish you may mark through the center of the grommets and then drill a 1/8" pilot hole by 1" deep before installing the pan head screws.
- 2) The "recessed area" in the grommet will receive the washer. Place a pan head screw through a washer. Place the screw centered through the grommet and drive it in. The washer should seat centered with the grommet. Repeat this process for all the grommets across the top of the mesh.
- 3) Go to each end of the mesh. Push the end of the mesh tight to the corner post or clatter bridge post. Then install screws and washers into the two grommets on each end of the mesh.
- 4) Repeat substeps 1 through 3 for the mesh panel on the lower bridge rail on the opposite side.



TWO
GROMMETS
AT END OF
MESH.

— CENTER THE MESH PANEL ON THE CLATTER BRIDGE RAIL ON THE INSIDE.
NOTE THE GROMMETS HAVE A RECESSED PART ON ONE SIDE AND IT SHOULD FACE YOU.

— YOU MAY PRE-DRILL 1/8" X 1" DEEP HOLES AT EACH GROMMET LOCATION ALONG THE TOP
PRIOR TO INSTALLING THE PAN HEAD SCREWS AND WASHERS PROVIDED.

****IMPORTANT** - Teach your children not to climb onto or hang from the mesh panels.
If the mesh ever becomes ripped please replace the damaged panel(s).**

****FOR AGES 3-11**
FOR RESIDENTIAL USE ONLY**

5) It will be very helpful to have an assistant at this stage. We recommend predrilling holes for the screws on the bottom of the deckboards fastened to the chains. Align the edge of the mesh border with the end of the bridge deck boards. Mark through the center grommet onto the deck board. Drill a 1/8" hole by 1" deep. Have your assistant push down on the board while you install a pan head screw and washer into the hole. Go from the center grommet to one end of the mesh and repeat the mark/drill/install fasteners procedure. Then go from the center grommet to the other side and do the same.



MARK THROUGH THE CENTER OF THE CENTER GROMMET ONTO THE MIDDLE DECK BOARD. DRILL A 1/8" X 1" DEEP HOLE AT THE MARK. PLACE A PAN HEAD SCREW THROUGH A WASHER AND INSTALL INTO THE HOLE. TRY TO CENTER THE WASHER ONTO THE GROMMET BEFORE TIGHTENING COMPLETELY.

ALIGN EDGE OF BORDER UNDER THE DECK WITH THE END OF THE 2 X 4 BRIDGE DECK BOARDS THAT ARE FASTENED TO THE CHAINS.



Example picture of the completed Clatter Bridge Mesh Panels.

SOLD SEPARATELY

CANOPY ACCENT (07-0032)

SOLD SEPARATELY

1: Center the Canopy Accent over the front or rear center post. The top of the Canopy Accent should be flush to the top of the center tarp board.

2: Install two #8 x 1-3/4" wood screws to secure the Canopy Accent to the front or rear center post.

Note: The Canopy Accent is sold individually with two screws. A single level play set such as the one shown below could use two Canopy Accents. One may be placed on the front center post as well as the rear center post.

A double level play set could use three Canopy Accents. One on the lower level front center post and two on the upper level front and rear center posts.

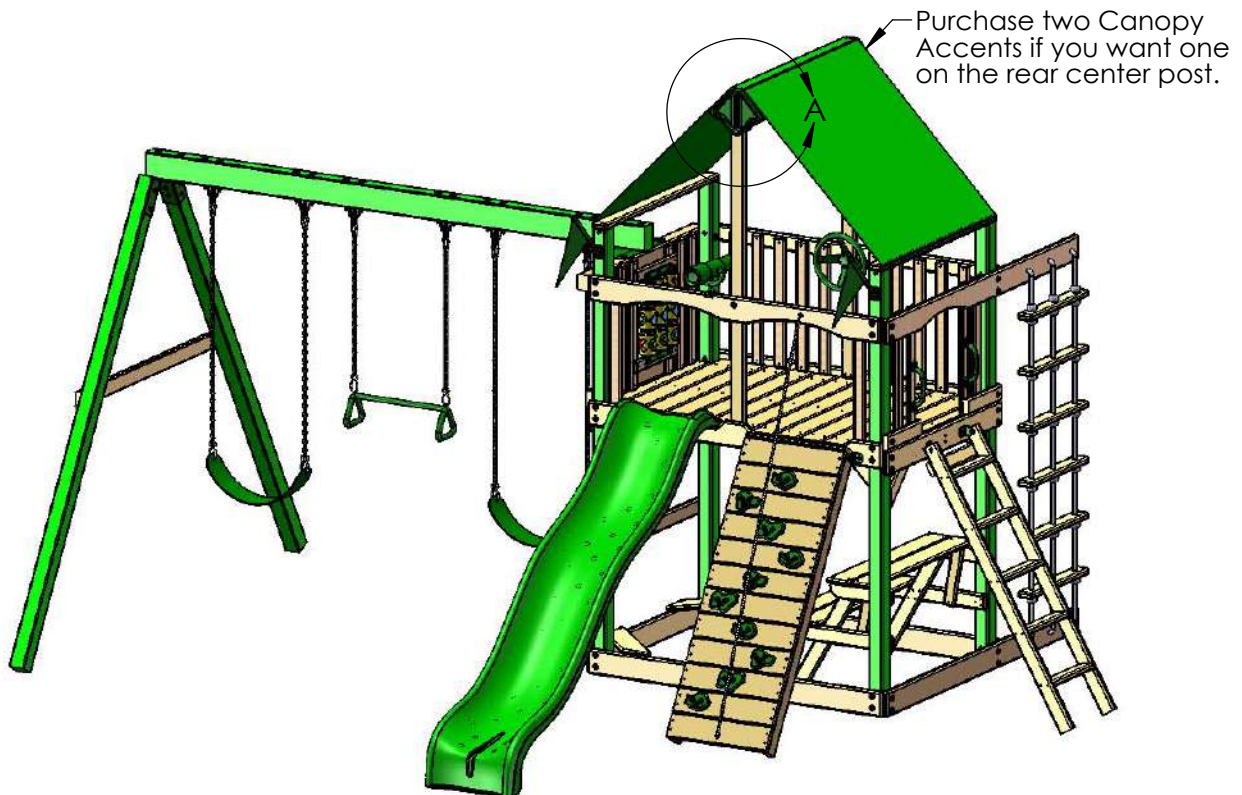
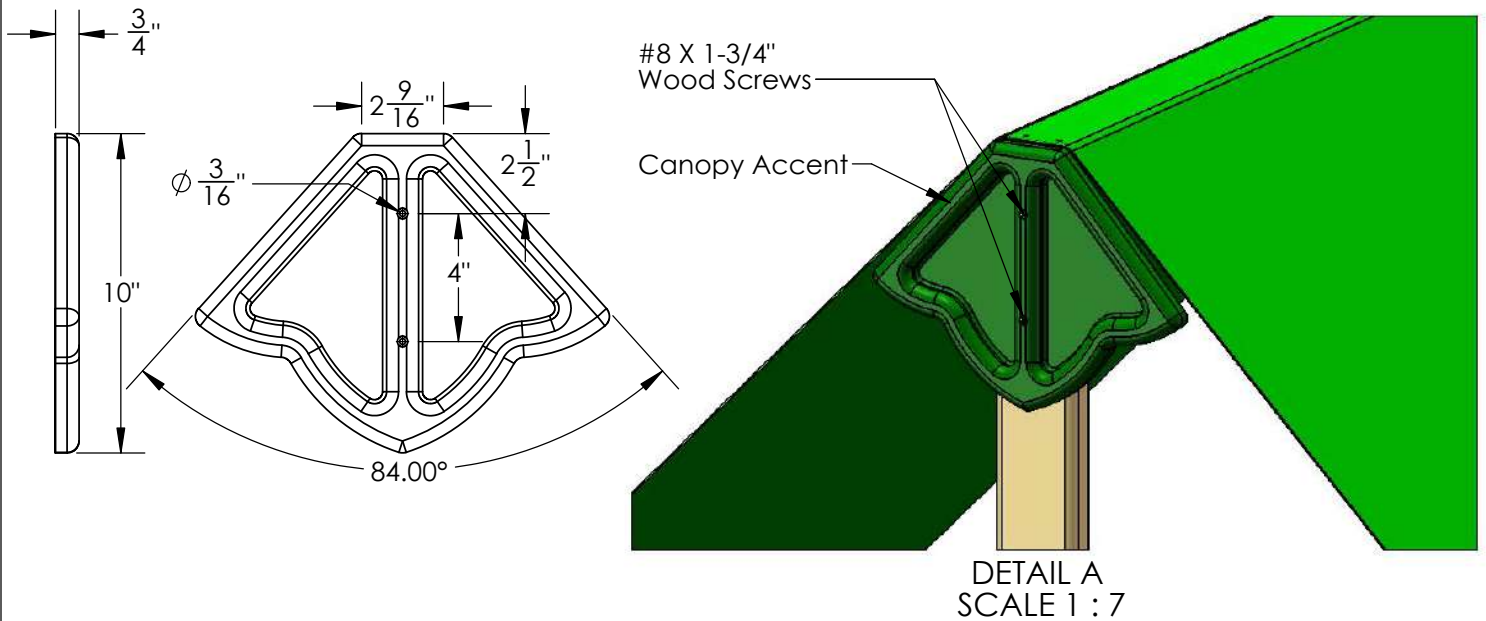

FOR RESIDENTIAL USE ONLY
FOR CHILDREN AGES 3-11

GROUND STAKES

1: HAMMER A GROUND STAKE INTO THE EARTH NEXT TO EACH SWING LEG AT AN ANGLE. DO NOT HOLD THE UPPER PORTION OF THE STAKE AFTER THE FIRST COUPLE OF HITS OR IT MAY VIBRATE HARSHLY AGAINST YOUR HAND. IF THE TOP PART OF THE STAKE TWISTS WHEN IT ENCOUNTERS A ROCK OR ROOT YOU MAY HAVE TO BEND THE TOP PORTION OF THE STAKE AGAINST THE SWING LEG. FINALLY INSTALL THE SCREW AND WASHER.

2: ATTACH EACH GROUND STAKE TO THE SWING LEG WITH A #14 X 2" PAN HEAD SCREW AND A 1/4" FENDER WASHER PROVIDED WITH THE GROUND STAKE.

